



This datasheet provides package and thermal resistance information for mature Altera® devices. Package information includes the ordering code reference, package acronym, leadframe material, lead finish (plating), JEDEC outline reference, lead coplanarity, weight, moisture sensitivity level, and other special information. The thermal resistance information includes device pin count, package name, and resistance values.

This datasheet includes the following sections:

- “Device and Package Cross Reference” on page 1
- “Thermal Resistance” on page 23
- “Package Outlines” on page 44

 For more package and thermal resistance information about Altera devices that are not listed in this datasheet, refer to the [Package and Thermal Resistance](#) page of the Altera website.

 For information about trays, tubes, and dry packs, refer to *AN 71: Guidelines for Handling J-Lead, QFP, and BGA Devices*.

 RoHS-compliant devices are compatible with leaded-reflow temperatures. For more information, refer to [Altera’s RoHS-Compliant Devices](#) literature page.

## Device and Package Cross Reference

Table 2 through Table 22 lists the device, package type, and number of pins for each Altera device listed in this datasheet. Altera devices listed in this datasheet are available in the following packages:

- Ball-Grid Array (BGA)
- Ceramic Pin-Grid Array (PGA)
- FineLine BGA (FBGA)
- Hybrid FineLine BGA (HBGA)
- Plastic Dual In-Line Package (PDIP)
- Plastic Enhanced Quad Flat Pack (EQFP)
- Plastic J-Lead Chip Carrier (PLCC)
- Plastic Quad Flat Pack (PQFP)
- Power Quad Flat Pack (RQFP)
- Thin Quad Flat Pack (TQFP)
- Ultra FineLine BGA (UBGA)

Table 1 lists the Altera devices and the associated table locations.

**Table 1.** Mature Altera Device and Package Cross Reference

| <b>Altera Device</b>           | <b>Table locations</b>  |
|--------------------------------|---|
| Arria® series FPGAs            | ■ Arria GX Devices: Table 2 on page 3   |
| Stratix® series FPGAs          | ■ Stratix II Devices: Table 3 on page 3<br>■ Stratix Devices: Table 4 on page 5   |
| Cyclone® series FPGAs          | ■ Cyclone II Devices: Table 5 on page 7<br>■ Cyclone Devices: Table 6 on page 8   |
| MAX® series CPLDs              | ■ MAX 9000 Devices: Table 7 on page 8<br>■ MAX 7000 Devices: Table 8 on page 9<br>■ MAX 3000A Devices: Table 9 on page 10   |
| HardCopy® series ASICs         | ■ HardCopy II Devices: Table 10 on page 11<br>■ HardCopy Devices: Table 11 on page 11<br>■ HardCopy APEX Devices: Table 12 on page 12                                     |
| APEX™ series FPGAs             | ■ APEX II Devices: Table 13 on page 13<br>■ APEX 20KE Devices: Table 14 on page 13<br>■ APEX 20KC Devices: Table 15 on page 15<br>■ APEX 20K Devices: Table 16 on page 15 |
| ACEX® 1K FPGAs                 | ACEX 1K Devices: Table 17 on page 16  |
| Mercury™ FPGAs                 | Mercury Devices: Table 18 on page 17  |
| FLEX® series FPGAs             | ■ FLEX 10KA Devices: Table 19 on page 17<br>■ FLEX 10KS Devices: Table 20 on page 18<br>■ FLEX 10KE Devices: Table 21 on page 18  |
| Excalibur™ FPGAs               | Excalibur Devices: Table 22 on page 21  |
| Configuration devices          | Configuration Devices: Table 23 on page 22  |
| Enhanced configuration devices | Enhanced Configuration Devices: Table 24 on page 22   |

## Arria GX Devices

Table 2 lists the device name, package type, and number of pins for the Arria GX device family.

 The package type entries with “Option #” refer to instances where multiple package options exist for a given package type and pin count. The option number identifies the specific type used by the corresponding device density.

**Table 2.** Arria GX Devices

| Device   | Package  | Pins |
|----------|--|------|
| EP1AGX20 | Dual-Piece Lid: FBGA, Flip Chip, Option 1<br>Single-Piece Lid: FBGA, Flip Chip, Option 4 | 484  |
|          | Dual-Piece Lid: FBGA, Flip Chip, Option 1<br>Single-Piece Lid: FBGA, Flip Chip, Option 3 | 780  |
| EP1AGX35 | Dual-Piece Lid: FBGA, Flip Chip, Option 1<br>Single-Piece Lid: FBGA, Flip Chip, Option 4 | 484  |
|          | Dual-Piece Lid: FBGA, Flip Chip, Option 1<br>Single-Piece Lid: FBGA, Flip Chip, Option 3 | 780  |
| EP1AGX50 | Channel Lid: FBGA, Flip Chip, Option 1   | 484  |
|          | Dual-Piece Lid: FBGA, Flip Chip, Option 1<br>Single-Piece Lid: FBGA, Flip Chip, Option 3 | 780  |
|          | Dual-Piece Lid: FBGA, Flip Chip, Option 1<br>Single-Piece Lid: FBGA, Flip Chip, Option 2 | 1152 |
| EP1AGX60 | Channel Lid: FBGA, Flip Chip, Option 1   | 484  |
|          | Dual-Piece Lid: FBGA, Flip Chip, Option 1<br>Single-Piece Lid: FBGA, Flip Chip, Option 3 | 780  |
|          | Dual-Piece Lid: FBGA, Flip Chip, Option 1<br>Single-Piece Lid: FBGA, Flip Chip, Option 2 | 1152 |
| EP1AGX90 | Dual-Piece Lid: FBGA, Flip Chip, Option 1<br>Single-Piece Lid: FBGA, Flip Chip, Option 2 | 1152 |

## Stratix II Devices

Table 3 lists the device name, package type, and number of pins for the Stratix II device family.

 The package type entries with “Option #” refer to instances where multiple package options exist for a given package type and pin count. The option number identifies the specific type used by the corresponding device density.

**Table 3.** Stratix II Devices (Part 1 of 2)

| Device | Package  | Pins |
|--------|--|------|
| EP2S15 | Dual-Piece Lid: FBGA, Flip Chip, Option 1<br>Single-Piece Lid: FBGA, Flip Chip, Option 4 | 484  |
|        | Dual-Piece Lid: FBGA, Flip Chip, Option 1<br>Single-Piece Lid: FBGA, Flip Chip, Option 4 | 672  |

**Table 3.** Stratix II Devices (Part 2 of 2)

| <b>Device</b> | <b>Package</b>   | <b>Pins</b> |
|---------------|--|-------------|
| EP2S30        | Dual-Piece Lid: FBGA, Flip Chip, Option 1<br>Single-Piece Lid: FBGA, Flip Chip, Option 4 | 484         |
|               | Dual-Piece Lid: FBGA, Flip Chip, Option 1<br>Single-Piece Lid: FBGA, Flip Chip, Option 4 | 672         |
| EP2S60        | Dual-Piece Lid: FBGA, Flip Chip, Option 1  | 484         |
|               | Dual-Piece Lid: FBGA, Flip Chip, Option 1<br>Single-Piece Lid: FBGA, Flip Chip, Option 4 | 672         |
|               | Dual-Piece Lid: FBGA, Flip Chip, Option 1<br>Single-Piece Lid: FBGA, Flip Chip, option 2 | 1020        |
| EP2S90        | Channel Lid: HBGA, Flip Chip   | 484         |
|               | Dual-Piece Lid: FBGA, Flip Chip, Option 1<br>Single-Piece Lid: FBGA, Flip Chip, Option 3 | 780         |
|               | Dual-Piece Lid: FBGA, Flip Chip, Option 1<br>Single-Piece Lid: FBGA, Flip Chip, Option 2 | 1020        |
|               | Dual-Piece Lid: FBGA, Flip Chip, Option 1<br>Single-Piece Lid: FBGA, Flip Chip, Option 2 | 1508        |
| EP2S130       | Channel Lid: FBGA, Flip Chip, Option 1   | 780         |
|               | Dual-Piece Lid: FBGA, Flip Chip, Option 1<br>Single-Piece Lid: FBGA, Flip Chip, Option 2 | 1020        |
|               | Dual-Piece Lid: FBGA, Flip Chip, Option 1<br>Single-Piece Lid: FBGA, Flip Chip, Option 2 | 1508        |
| EP2S180       | Dual-Piece Lid: FBGA, Flip Chip, Option 1<br>Single-Piece Lid: FBGA, Flip Chip, Option 2 | 1020        |
|               | Dual-Piece Lid: FBGA, Flip Chip, Option 1<br>Single-Piece Lid: FBGA, Flip Chip, Option 2 | 1508        |
| EP2SGX30      | Dual-Piece Lid: FBGA, Flip Chip, Option 1<br>Single-Piece Lid: FBGA, Flip Chip, Option 3 | 780         |
| EP2SGX60      | Dual-Piece Lid: FBGA, Flip Chip, Option 1<br>Single-Piece Lid: FBGA, Flip Chip, Option 3 | 780         |
|               | Dual-Piece Lid: FBGA, Flip Chip, Option 1<br>Single-Piece Lid: FBGA, Flip Chip, Option 2 | 1152        |
| EP2SGX90      | Dual-Piece Lid: FBGA, Flip Chip, Option 1<br>Single-Piece Lid: FBGA, Flip Chip, Option 2 | 1152        |
|               | Dual-Piece Lid: FBGA, Flip Chip, Option 1<br>Single-Piece Lid: FBGA, Flip Chip, Option 2 | 1508        |
| EP2SGX130     | Dual-Piece Lid: FBGA, Flip Chip, Option 1<br>Single-Piece Lid: FBGA, Flip Chip, Option 2 | 1508        |

## Stratix Devices

Table 4 lists the device name, package type, and number of pins for the Stratix device family.



The package type entries with “Option #” refer to instances where multiple package options exist for a given package type and pin count. The option number identifies the specific type used by the corresponding device density.

**Table 4.** Stratix Devices (Part 1 of 2)

| Device                                     | Package                                     | Pins |
|--|---|------|
| EP1SGX10                                   | Dual-Piece Lid: FBGA, Flip Chip, Option 1   | 672  |
|  | Single-Piece Lid: FBGA, Flip Chip, Option 4 |      |
| EP1SGX25                                   | Dual-Piece Lid: FBGA, Flip Chip, Option 1   | 672  |
|  | Single-Piece Lid: FBGA, Flip Chip, Option 4 |      |
| EP1SGX40                                   | Dual-Piece Lid: FBGA, Flip Chip, Option 1   | 1020 |
|  | Single-Piece Lid: FBGA, Flip Chip, Option 2 |      |
| EP1S10                                     | Dual-Piece Lid: FBGA, Flip Chip, Option 1   | 484  |
|  | Single-Piece Lid: FBGA, Flip Chip, Option 4 |      |
|  | BGA, Wire Bond                              | 672  |
|  | FBGA, Wire Bond, Option 2                   | 672  |
| EP1S20                                     | Dual-Piece Lid: FBGA, Flip Chip, Option 1   | 484  |
|  | Single-Piece Lid: FBGA, Flip Chip, Option 4 |      |
|  | BGA, Wire Bond                              | 672  |
|  | FBGA, Wire Bond, Option 2                   | 672  |
| EP1S25                                     | Dual-Piece Lid: FBGA, Flip Chip, Option 1   | 780  |
|  | Single-Piece Lid: FBGA, Flip Chip, Option 3 |      |
|  | Dual-Piece Lid: FBGA, Flip Chip, Option 1   | 1020 |
|  | Single-Piece Lid: FBGA, Flip Chip, Option 2 |      |
| EP1S30                                     | Dual-Piece Lid: FBGA, Flip Chip, Option 1   | 780  |
|  | Single-Piece Lid: FBGA, Flip Chip, Option 3 |      |
|  | Dual-Piece Lid: BGA, Flip Chip, Option 1    | 956  |
| Single-Piece Lid: BGA, Flip Chip, Option 2 |   |      |
| EP1S30                                     | Dual-Piece Lid: FBGA, Flip Chip, Option 1   | 1020 |
|  | Single-Piece Lid: FBGA, Flip Chip, Option 2 |      |

**Table 4.** Stratix Devices (Part 2 of 2)

| <b>Device</b> | <b>Package</b>   | <b>Pins</b> |
|---------------|--|-------------|
| EP1S40        | Dual-Piece Lid: FBGA, Flip Chip, Option 1<br>Single-Piece Lid: FBGA, Flip Chip, Option 3 | 780         |
|               | Dual-Piece Lid: BGA, Flip Chip, Option 1<br>Single-Piece Lid: BGA, Flip Chip, Option 2   | 956         |
|               | Dual-Piece Lid: FBGA, Flip Chip, Option 1<br>Single-Piece Lid: FBGA, Flip Chip, Option 2 | 1020        |
|               | Dual-Piece Lid: FBGA, Flip Chip, Option 1<br>Single-Piece Lid: FBGA, Flip Chip, Option 2 | 1508        |
| EP1S60        | Dual-Piece Lid: BGA, Flip Chip, Option 1<br>Single-Piece Lid: BGA, Flip Chip, Option 2   | 956         |
|               | Dual-Piece Lid: FBGA, Flip Chip, Option 1<br>Single-Piece Lid: FBGA, Flip Chip, Option 2 | 1020        |
|               | Dual-Piece Lid: FBGA, Flip Chip, Option 1<br>Single-Piece Lid: FBGA, Flip Chip, Option 2 | 1508        |
| EP1S80        | Dual-Piece Lid: BGA, Flip Chip, Option 1<br>Single-Piece Lid: BGA, Flip Chip, Option 2   | 956         |
|               | Dual-Piece Lid: FBGA, Flip Chip, Option 1  | 1020        |
|               | Dual-Piece Lid: FBGA, Flip Chip, Option 1<br>Single-Piece Lid: FBGA, Flip Chip, Option 2 | 1508        |

## Cyclone II Devices

Table 5 lists the device name, package type, and number of pins for the Cyclone II device family.



The package type entries with “Option #” refer to instances where multiple package options exist for a given package type and pin count. The option number identifies the specific type used by the corresponding device density.

**Table 5.** Cyclone II Devices

| Device  | Package                         | Pins |
|---------|---------------------------------|------|
| EP2C5   | TQFP, Wire Bond                 | 144  |
|         | PQFP, Wire Bond                 | 208  |
|         | FBGA, Wire Bond, Option 2, Thin | 256  |
| EP2C8   | TQFP, Wire Bond                 | 144  |
|         | PQFP, Wire Bond                 | 208  |
|         | FBGA, Wire Bond, Option 2, Thin | 256  |
| EP2C8A  | FBGA, Wire Bond, Option 2, Thin | 256  |
| EP2C15A | FBGA, Wire Bond, Option 2, Thin | 256  |
|         | FBGA, Wire Bond, A:2.40         | 484  |
| EP2C20  | PQFP, Wire Bond                 | 240  |
|         | FBGA, Wire Bond, Option 2, Thin | 256  |
|         | FBGA, Wire Bond, A:2.40         | 484  |
| EP2C20A | FBGA, Wire Bond, Option 2, Thin | 256  |
|         | FBGA, Wire Bond, A:2.40         | 484  |
| EP2C35  | FBGA, Wire Bond, A:2.40         | 484  |
|         | UBGA, Wire Bond                 | 484  |
|         | FBGA, Wire Bond, A:2.40         | 672  |
| EP2C50  | FBGA, Wire Bond, A:2.40         | 484  |
|         | UBGA, Wire Bond                 | 484  |
|         | FBGA, Wire Bond, A:2.40         | 672  |
| EP2C70  | FBGA, Wire Bond, A:2.40         | 672  |
|         | FBGA, Wire Bond, A:2.40         | 896  |

## Cyclone Devices

Table 6 lists the device name, package type, and number of pins for the Cyclone device family.



The package type entries with “Option #” refer to instances where multiple package options exist for a given package type and pin count. The option number identifies the specific type used by the corresponding device density.

**Table 6.** Cyclone Devices

| Device | Package                   | Pins |
|--------|---------------------------|------|
| EP1C3  | TQFP, Wire Bond           | 100  |
|        | TQFP, Wire Bond           | 144  |
| EP1C4  | FBGA, Wire Bond, Option 1 | 324  |
|        | FBGA, Wire Bond           | 400  |
| EP1C6  | TQFP, Wire Bond           | 144  |
|        | PQFP, Wire Bond           | 240  |
|        | FBGA, Wire Bond, Option 1 | 256  |
| EP1C12 | PQFP, Wire Bond           | 240  |
|        | FBGA, Wire Bond, Option 1 | 256  |
|        | FBGA, Wire Bond, Option 1 | 324  |
| EP1C20 | FBGA, Wire Bond, Option 1 | 324  |
|        | FBGA, Wire Bond           | 400  |

## MAX 9000 Devices

Table 7 lists the device name, package type, and number of pins for the MAX 9000 device family.

**Table 7.** MAX 9000 Devices

| Device   | Package        | Pins |
|----------|----------------|------|
| EPM9320  | BGA, Wire Bond | 356  |
| EPM9320A | BGA, Wire Bond | 356  |
| EPM9560  | BGA, Wire Bond | 356  |

## MAX 7000 Devices

Table 8 lists the device name, package type, and number of pins for the MAX 7000 device family.



The package type entries with “Option #” refer to instances where multiple package options exist for a given package type and pin count. The option number identifies the specific type used by the corresponding device density.

**Table 8.** MAX 7000 Devices (Part 1 of 2)

| <b>Device</b> | <b>Package</b>            | <b>Pins</b> |
|---------------|---------------------------|-------------|
| EPM7032B      | PLCC, Wire Bond           | 44          |
|               | TQFP, Wire Bond           | 44          |
|               | UBGA, Wire Bond           | 49          |
| EPM7064B      | TQFP, Wire Bond           | 44          |
|               | UBGA, Wire Bond           | 49          |
|               | FBGA, Wire Bond, Option 1 | 100         |
|               | TQFP, Wire Bond           | 100         |
| EPM7128B      | UBGA, Wire Bond           | 49          |
|               | TQFP, Wire Bond           | 100         |
|               | FBGA, Wire Bond, Option 1 | 100         |
|               | TQFP, Wire Bond           | 144         |
|               | UBGA, Wire Bond           | 169         |
|               | FBGA, Wire Bond, Option 1 | 256         |
| EPM7256B      | TQFP, Wire Bond           | 100         |
|               | TQFP, Wire Bond           | 144         |
|               | UBGA, Wire Bond           | 169         |
|               | PQFP, Wire Bond           | 208         |
|               | FBGA, Wire Bond, Option 1 | 256         |
| EPM7512B      | TQFP, Wire Bond           | 144         |
|               | UBGA, Wire Bond           | 169         |
|               | PQFP, Wire Bond           | 208         |
|               | FBGA, Wire Bond, Option 1 | 256         |
|               | BGA, Wire Bond, Option 1  | 256         |
| EPM7032AE     | PLCC, Wire Bond           | 44          |
|               | TQFP, Wire Bond           | 44          |
| EPM7064AE     | PLCC, Wire Bond           | 44          |
|               | UBGA, Wire Bond           | 49          |
|               | FBGA, Wire Bond, Option 1 | 100         |
|               | TQFP, Wire Bond           | 44          |
|               | TQFP, Wire Bond           | 100         |
|               | FBGA, Wire Bond, Option 1 | 256         |
| EPM7128AE     | PLCC, Wire Bond           | 84          |
|               | FBGA, Wire Bond, Option 1 | 100         |
|               | TQFP, Wire Bond           | 100         |
|               | TQFP, Wire Bond           | 144         |
|               | UBGA, Wire Bond           | 169         |
|               | FBGA, Wire Bond, Option 1 | 256         |

**Table 8.** MAX 7000 Devices (Part 2 of 2)

| Device    | Package                   | Pins |
|-----------|---------------------------|------|
| EPM7256AE | TQFP, Wire Bond           | 100  |
|           | FBGA, Wire Bond, Option 1 | 100  |
|           | TQFP, Wire Bond           | 144  |
|           | PQFP, Wire Bond           | 208  |
|           | FBGA, Wire Bond, Option 1 | 256  |
| EPM7512AE | TQFP, Wire Bond           | 144  |
|           | PQFP, Wire Bond           | 208  |
|           | BGA, Wire Bond, Option 1  | 256  |
|           | FBGA, Wire Bond, Option 1 | 256  |
| EPM7032A  | PLCC, Wire Bond           | 44   |
|           | TQFP, Wire Bond           | 44   |
| EPM7128A  | PLCC, Wire Bond           | 84   |
|           | TQFP, Wire Bond           | 100  |
|           | FBGA, Wire Bond           | 100  |
|           | TQFP, Wire Bond           | 144  |
|           | FBGA, Wire Bond, Option 1 | 256  |
| EPM7256A  | TQFP, Wire Bond           | 100  |
|           | TQFP, Wire Bond           | 144  |
|           | PQFP, Wire Bond           | 208  |
|           | FBGA, Wire Bond, Option 1 | 256  |
| EPM7192E  | PGA, Wire Bond            | 160  |
|           | PQFP, Wire Bond           | 160  |

## MAX 3000A Devices

Table 8 lists the device name, package type, and number of pins for the MAX 3000A device family.



The package type entries with “Option #” refer to instances where multiple package options exist for a given package type and pin count. The option number identifies the specific type used by the corresponding device density.

**Table 9.** MAX 3000A Devices (Part 1 of 2)

| Device   | Package         | Pins |
|----------|-----------------|------|
| EPM3032A | PLCC, Wire Bond | 44   |
|          | TQFP, Wire Bond | 44   |
| EPM3064A | TQFP, Wire Bond | 44   |
|          | PLCC, Wire Bond | 44   |
|          | TQFP, Wire Bond | 100  |
| EPM3128A | TQFP, Wire Bond | 100  |

**Table 9.** MAX 3000A Devices (Part 2 of 2)

| Device   | Package                   | Pins |
|----------|---------------------------|------|
| EPM3256A | TQFP, Wire Bond           | 144  |
|          | PQFP, Wire Bond           | 208  |
| EPM3512A | PQFP, Wire Bond           | 208  |
|          | FBGA, Wire Bond, Option 1 | 256  |

## HardCopy II Devices

Table 10 lists the device name, package type, and number of pins for the HardCopy II device family.



The package type entries with “Option #” refer to instances where multiple package options exist for a given package type and pin count. The option number identifies the specific type used by the corresponding device density.

**Table 10.** HardCopy II Devices

| Device | Package                                     | Pins |
|--------|---|------|
| HC210  | FBGA, Wire Bond, A:2.40                     | 484  |
| HC220  | Single-Piece Lid: FBGA, Flip Chip, Option 4 | 672  |
|        | Single-Piece Lid: FBGA, Flip Chip, Option 3 | 780  |
| HC230  | Single-Piece Lid: FBGA, Flip Chip, Option 2 | 1020 |
| HC240  | Single-Piece Lid: FBGA, Flip Chip, Option 2 | 1020 |
|        | Single-Piece Lid: FBGA, Flip Chip, Option 2 | 1508 |

## HardCopy Devices

Table 11 lists the device name, package type, and number of pins for the HardCopy device family.



The package type entries with “Option #” refer to instances where multiple package options exist for a given package type and pin count. The option number identifies the specific type used by the corresponding device density.

**Table 11.** HardCopy Devices

| Device | Package                                   | Pins |
|--------|---|------|
| HC1S25 | FBGA, Wire Bond, A:2.40                   | 672  |
|        | BGA, Wire Bond                            | 672  |
| HC1S30 | Dual-Piece Lid: FBGA, Flip Chip, Option 1 | 780  |
| HC1S40 | Dual-Piece Lid: FBGA, Flip Chip, Option 1 | 780  |
| HC1S60 | Dual-Piece Lid: FBGA, Flip Chip, Option 1 | 1020 |
| HC1S80 | Dual-Piece Lid: FBGA, Flip Chip, Option 1 | 1020 |

## HardCopy APEX Devices

Table 12 lists the device name, package type, and number of pins for the HardCopy APEX device family.



The package type entries with “Option #” refer to instances where multiple package options exist for a given package type and pin count. The option number identifies the specific type used by the corresponding device density.

**Table 12.** HardCopy APEX Devices

| Device   | Package                                   | Pins |
|----------|---|------|
| HC20K400 | BGA, Wire Bond, Option 3                  | 652  |
| HC20K600 | BGA, Wire Bond, Option 3                  | 652  |
|          | Dual-Piece Lid: FBGA, Flip Chip, Option 1 | 672  |

## APEX II Devices

Table 13 lists the device name, package type, and number of pins for the APEX II device family.

 The package type entries with “Option #” refer to instances where multiple package options exist for a given package type and pin count. The option number identifies the specific type used by the corresponding device density.

**Table 13.** APEX II Devices

| Device | Package                                   | Pins |
|--------|---|------|
| EP2A15 | Dual-Piece Lid: FBGA, Flip Chip, Option 1 | 672  |
|        | Dual-Piece Lid: BGA, Flip Chip            | 724  |
| EP2A25 | Channel Lid: FBGA, Flip Chip, Option 1    | 672  |
|        | Dual-Piece Lid: BGA, Flip Chip            | 724  |
|        | Dual-Piece Lid: FBGA, Flip Chip, Option 1 | 1020 |
| EP2A40 | Channel Lid: FBGA, Flip Chip, Option 1    | 672  |
|        | Dual-Piece Lid: BGA, Flip Chip            | 724  |
|        | Dual-Piece Lid: FBGA, Flip Chip, Option 1 | 1020 |
| EP2A70 | Dual-Piece Lid: BGA, Flip Chip            | 724  |
|        | Dual-Piece Lid: FBGA, Flip Chip, Option 1 | 1508 |

## APEX 20KE Devices

Table 14 lists the device name, package type, and number of pins for the APEX 20KE device family.

 The package type entries with “Option #” refer to instances where multiple package options exist for a given package type and pin count. The option number identifies the specific type used by the corresponding device density.

**Table 14.** APEX 20KE Devices (Part 1 of 2)

| Device   | Package                   | Pins |
|----------|---------------------------|------|
| EP20K30E | FBGA, Wire Bond           | 144  |
|          | TQFP, Wire Bond           | 144  |
|          | PQFP, Wire Bond           | 208  |
|          | FBGA, Wire Bond, Option 1 | 324  |
| EP20K60E | FBGA, Wire Bond           | 144  |
|          | TQFP, Wire Bond           | 144  |
|          | PQFP, Wire Bond           | 208  |
|          | PQFP, Wire Bond           | 240  |
|          | FBGA, Wire Bond, Option 1 | 324  |
|          | BGA, Wire Bond            | 356  |

**Table 14.** APEX 20KE Devices (Part 2 of 2)

| <b>Device</b> | <b>Package</b>            | <b>Pins</b> |
|---------------|---------------------------|-------------|
| EP20K100E     | FBGA, Wire Bond           | 144         |
|               | TQFP, Wire Bond           | 144         |
|               | PQFP, Wire Bond           | 208         |
|               | PQFP, Wire Bond           | 240         |
|               | FBGA, Wire Bond, Option 1 | 324         |
|               | BGA, Wire Bond            | 356         |
| EP20K160E     | TQFP, Wire Bond           | 144         |
|               | PQFP, Wire Bond           | 208         |
|               | PQFP, Wire Bond           | 240         |
|               | BGA, Wire Bond            | 356         |
|               | FBGA, Wire Bond, Option 2 | 484         |
| EP20K200E     | PQFP, Wire Bond           | 208         |
|               | PQFP, Wire Bond           | 240         |
|               | BGA, Wire Bond            | 356         |
|               | FBGA, Wire Bond, Option 2 | 484         |
|               | BGA, Wire Bond, Option 2  | 652         |
|               | FBGA, Wire Bond, Option 2 | 672         |
| EP20K300E     | PQFP, Wire Bond           | 240         |
|               | BGA, Wire Bond, Option 2  | 652         |
|               | FBGA, Wire Bond, Option 2 | 672         |
| EP20K400E     | BGA, Wire Bond, Option 3  | 652         |
|               | FBGA, Flip Chip, Option 1 | 672         |
| EP20K600E     | BGA, Wire Bond, Option 3  | 652         |
|               | FBGA, Flip Chip, Option 1 | 672         |
|               | FBGA, Flip Chip, Option 1 | 1020        |
| EP20K1000E    | BGA, Flip Chip            | 652         |
|               | FBGA, Flip Chip, Option 1 | 672         |
|               | FBGA, Flip Chip, Option 1 | 1020        |
| EP20K1500E    | BGA, Flip Chip            | 652         |
|               | FBGA, Flip Chip, Option 1 | 1020        |

## APEX 20KC Devices

Table 15 lists the device name, package type, and number of pins for the APEX 20KC device family.

 The package type entries with “Option #” refer to instances where multiple package options exist for a given package type and pin count. The option number identifies the specific type used by the corresponding device density.

**Table 15.** APEX 20KC Devices

| Device     | Package                   | Pins |
|------------|---------------------------|------|
| EP20K200C  | PQFP, Wire Bond           | 208  |
|            | PQFP, Wire Bond           | 240  |
|            | BGA, Wire Bond            | 356  |
|            | FBGA, Wire Bond, Option 2 | 484  |
| EP20K400C  | BGA, Wire Bond, Option 3  | 652  |
|            | FBGA, Flip Chip, Option 1 | 672  |
| EP20K600C  | BGA, Wire Bond, Option 3  | 652  |
|            | FBGA, Flip Chip, Option 1 | 672  |
|            | FBGA, Flip Chip, Option 1 | 1020 |
| EP20K1000C | BGA, Flip Chip            | 652  |
|            | FBGA, Flip Chip, Option 1 | 672  |
|            | FBGA, Flip Chip, Option 1 | 1020 |

## APEX 20K Devices

Table 16 lists the device name, package type, and number of pins for the APEX 20K device family.

 The package type entries with “Option #” refer to instances where multiple package options exist for a given package type and pin count. The option number identifies the specific type used by the corresponding device density.

**Table 16.** APEX 20K Devices (Part 1 of 2)

| Device   | Package                   | Pins |
|----------|---------------------------|------|
| EP20K100 | TQFP, Wire Bond           | 144  |
|          | PQFP, Wire Bond           | 208  |
|          | PQFP, Wire Bond           | 240  |
|          | FBGA, Wire Bond, Option 1 | 324  |
|          | BGA, Wire Bond            | 356  |
| EP20K160 | PQFP, Wire Bond           | 240  |
|          | TQFP, Wire Bond           | 144  |

**Table 16.** APEX 20K Devices (Part 2 of 2)

| Device   | Package                   | Pins |
|----------|---------------------------|------|
| EP20K200 | PQFP, Wire Bond           | 208  |
|          | PQFP, Wire Bond           | 240  |
|          | BGA, Wire Bond            | 356  |
|          | FBGA, Wire Bond, Option 2 | 484  |
| EP20K300 | FBGA, Wire Bond, Option 2 | 672  |
| EP20K400 | BGA, Wire Bond, Option 3  | 652  |
|          | PGA, Wire Bond            | 655  |
|          | FBGA, Flip Chip, Option 1 | 672  |

## ACEX 1K Devices

Table 17 lists the device name, package type, and number of pins for the ACE 1K device family.



The package type entries with “Option #” refer to instances where multiple package options exist for a given package type and pin count. The option number identifies the specific type used by the corresponding device density.

**Table 17.** ACEX 1K Devices

| Device  | Package                   | Pins |
|---------|---------------------------|------|
| EP1K10  | TQFP, Wire Bond           | 100  |
|         | TQFP, Wire Bond           | 144  |
|         | PQFP, Wire Bond           | 208  |
|         | FBGA, Wire Bond, Option 1 | 256  |
| EP1K30  | TQFP, Wire Bond           | 144  |
|         | PQFP, Wire Bond           | 208  |
|         | FBGA, Wire Bond, Option 1 | 256  |
| EP1K50  | TQFP, Wire Bond           | 144  |
|         | PQFP, Wire Bond           | 208  |
|         | FBGA, Wire Bond, Option 1 | 256  |
|         | FBGA, Wire Bond, Option 2 | 484  |
| EP1K100 | PQFP, Wire Bond           | 208  |
|         | FBGA, Wire Bond, Option 1 | 256  |
|         | FBGA, Wire Bond, Option 2 | 484  |

## Mercury Devices

Table 18 lists the device name, package type, and number of pins for the Mercury device family.

 The package type entries with “Option #” refer to instances where multiple package options exist for a given package type and pin count. The option number identifies the specific type used by the corresponding device density.

**Table 18.** Mercury Devices

| Device  | Package                                   | Pins |
|---------|---|------|
| EP1M120 | Dual-Piece Lid: FBGA, Flip Chip, Option 1 | 484  |
| EP1M350 | Dual-Piece Lid: FBGA, Flip Chip, Option 1 | 780  |

## FLEX 10KA Devices

Table 19 lists the device name, package type, and number of pins for the FLEX 10KA device family.

 The package type entries with “Option #” refer to instances where multiple package options exist for a given package type and pin count. The option number identifies the specific type used by the corresponding device density.

**Table 19.** FLEX 10KA Devices

| Device     | Package                   | Pins |
|------------|---------------------------|------|
| EPF10K10A  | TQFP, Wire Bond           | 100  |
|            | TQFP, Wire Bond           | 144  |
|            | PQFP, Wire Bond           | 208  |
|            | FBGA, Wire Bond, Option 1 | 256  |
| EPF10K30A  | TQFP, Wire Bond           | 144  |
|            | PQFP, Wire Bond           | 208  |
|            | PQFP, Wire Bond           | 240  |
|            | FBGA, Wire Bond, Option 1 | 256  |
|            | BGA, Wire Bond            | 356  |
|            | FBGA, Wire Bond, Option 2 | 484  |
| EPF10K100A | RQFP, Wire Bond           | 240  |
|            | BGA, Wire Bond            | 356  |
|            | FBGA, Wire Bond, Option 2 | 484  |
|            | BGA, Wire Bond            | 600  |
| EPF10K250A | PGA, Wire Bond            | 599  |
|            | BGA, Wire Bond            | 600  |

## FLEX 10KS Devices

Table 20 lists the device name, package type, and number of pins for the FLEX 10KS device family.



The package type entries with “Option #” refer to instances where multiple package options exist for a given package type and pin count. The option number identifies the specific type used by the corresponding device density.

**Table 20.** FLEX 10KS Devices

| Device     | Package                   | Pins |
|------------|---------------------------|------|
| EPF10K50S  | TQFP, Wire Bond           | 144  |
|            | PQFP, Wire Bond           | 208  |
|            | PQFP, Wire Bond           | 240  |
|            | FBGA, Wire Bond, Option 1 | 256  |
|            | BGA, Wire Bond            | 356  |
|            | FBGA, Wire Bond, Option 2 | 484  |
| EPF10K200S | RQFP, Wire Bond           | 240  |
|            | BGA, Wire Bond            | 356  |
|            | FBGA, Wire Bond, Option 2 | 484  |
|            | BGA, Wire Bond            | 600  |
|            | FBGA, Wire Bond, Option 2 | 672  |

## FLEX 10KE Devices

Table 21 lists the device name, package type, and number of pins for the FLEX 10KE device family.



The package type entries with “Option #” refer to instances where multiple package options exist for a given package type and pin count. The option number identifies the specific type used by the corresponding device density.

**Table 21.** FLEX 10KE Devices (Part 1 of 3)

| Device    | Package                   | Pins |
|-----------|---------------------------|------|
| EPF10K30E | TQFP, Wire Bond           | 144  |
|           | PQFP, Wire Bond           | 208  |
|           | FBGA, Wire Bond, Option 1 | 256  |
|           | FBGA, Wire Bond, Option 2 | 484  |
| EPF10K50E | TQFP, Wire Bond           | 144  |
|           | PQFP, Wire Bond           | 208  |
|           | PQFP, Wire Bond           | 240  |
|           | FBGA, Wire Bond, Option 1 | 256  |
|           | BGA, Wire Bond            | 356  |
|           | FBGA, Wire Bond, Option 2 | 484  |

**Table 21.** FLEX 10KE Devices (Part 2 of 3)

| Device     | Package                   | Pins |
|------------|---------------------------|------|
| EPF10K100E | PQFP, Wire Bond           | 208  |
|            | PQFP, Wire Bond           | 240  |
|            | FBGA, Wire Bond, Option 1 | 256  |
|            | BGA, Wire Bond            | 356  |
|            | FBGA, Wire Bond, Option 2 | 484  |
| EPF10K130E | PQFP, Wire Bond           | 240  |
|            | BGA, Wire Bond            | 356  |
|            | FBGA, Wire Bond, Option 2 | 484  |
|            | BGA, Wire Bond            | 600  |
|            | FBGA, Wire Bond, Option 2 | 672  |
| EPF10K200E | PGA, Wire Bond            | 599  |
|            | BGA, Wire Bond            | 600  |
|            | FBGA, Wire Bond, Option 2 | 672  |
| EPF10K10   | PLCC, Wire Bond           | 84   |
|            | TQFP, Wire Bond           | 144  |
|            | PQFP, Wire Bond           | 208  |
| EPF10K20   | TQFP, Wire Bond           | 144  |
|            | RQFP, Wire Bond           | 208  |
|            | RQFP, Wire Bond           | 240  |
| EPF10K30   | RQFP, Wire Bond           | 208  |
|            | RQFP, Wire Bond           | 240  |
|            | BGA, Wire Bond            | 356  |
| EPF10K40   | RQFP, Wire Bond           | 208  |
|            | RQFP, Wire Bond           | 240  |
| EPF10K50   | RQFP, Wire Bond           | 240  |
|            | BGA, Wire Bond            | 356  |
|            | PGA, Wire Bond            | 403  |
| EPF10K50V  | RQFP, Wire Bond           | 240  |
|            | PQFP, Wire Bond           | 240  |
|            | BGA, Wire Bond            | 356  |
|            | FBGA, Wire Bond           | 484  |
| EPF10K70   | RQFP, Wire Bond           | 240  |
|            | PGA, Wire Bond            | 503  |
| EPF10K100  | PGA, Wire Bond            | 503  |
| EPF10K130V | PGA, Wire Bond            | 599  |
|            | BGA, Wire Bond            | 600  |
| EPF6010A   | TQFP, Wire Bond           | 100  |
|            | TQFP, Wire Bond           | 144  |
|            | PQFP, Wire Bond           | 208  |

**Table 21.** FLEX 10KE Devices (Part 2 of 3)

| Device     | Package                   | Pins |
|------------|---------------------------|------|
| EPF10K100E | PQFP, Wire Bond           | 208  |
|            | PQFP, Wire Bond           | 240  |
|            | FBGA, Wire Bond, Option 1 | 256  |
|            | BGA, Wire Bond            | 356  |
|            | FBGA, Wire Bond, Option 2 | 484  |
| EPF10K130E | PQFP, Wire Bond           | 240  |
|            | BGA, Wire Bond            | 356  |
|            | FBGA, Wire Bond, Option 2 | 484  |
|            | BGA, Wire Bond            | 600  |
|            | FBGA, Wire Bond, Option 2 | 672  |
| EPF10K200E | PGA, Wire Bond            | 599  |
|            | BGA, Wire Bond            | 600  |
|            | FBGA, Wire Bond, Option 2 | 672  |
| EPF10K10   | PLCC, Wire Bond           | 84   |
|            | TQFP, Wire Bond           | 144  |
|            | PQFP, Wire Bond           | 208  |
| EPF10K20   | TQFP, Wire Bond           | 144  |
|            | RQFP, Wire Bond           | 208  |
|            | RQFP, Wire Bond           | 240  |
| EPF10K30   | RQFP, Wire Bond           | 208  |
|            | RQFP, Wire Bond           | 240  |
|            | BGA, Wire Bond            | 356  |
| EPF10K40   | RQFP, Wire Bond           | 208  |
|            | RQFP, Wire Bond           | 240  |
| EPF10K50   | RQFP, Wire Bond           | 240  |
|            | BGA, Wire Bond            | 356  |
|            | PGA, Wire Bond            | 403  |
| EPF10K50V  | RQFP, Wire Bond           | 240  |
|            | PQFP, Wire Bond           | 240  |
|            | BGA, Wire Bond            | 356  |
|            | FBGA, Wire Bond           | 484  |
| EPF10K70   | RQFP, Wire Bond           | 240  |
|            | PGA, Wire Bond            | 503  |
| EPF10K100  | PGA, Wire Bond            | 503  |
| EPF10K130V | PGA, Wire Bond            | 599  |
|            | BGA, Wire Bond            | 600  |
| EPF6010A   | TQFP, Wire Bond           | 100  |
|            | TQFP, Wire Bond           | 144  |
|            | PQFP, Wire Bond           | 208  |

**Table 21.** FLEX 10KE Devices (Part 3 of 3)

| Device   | Package                   | Pins |
|----------|---------------------------|------|
| EPF6016  | TQFP, Wire Bond           | 144  |
|          | PQFP, Wire Bond           | 208  |
|          | PQFP, Wire Bond           | 240  |
|          | BGA, Wire Bond, Option 2  | 256  |
| EPF6016A | TQFP, Wire Bond           | 100  |
|          | FBGA, Wire Bond           | 100  |
|          | TQFP, Wire Bond           | 144  |
|          | PQFP, Wire Bond           | 208  |
|          | FBGA, Wire Bond, Option 1 | 256  |
| EPF6024A | TQFP, Wire Bond           | 144  |
|          | PQFP, Wire Bond           | 208  |
|          | PQFP, Wire Bond           | 240  |
|          | BGA, Wire Bond, Option 2  | 256  |
|          | FBGA, Wire Bond, Option 1 | 256  |
| EPF8282A | PLCC, Wire Bond           | 84   |
|          | TQFP, Wire Bond           | 100  |
| EPF8452A | TQFP, Wire Bond           | 100  |
|          | PQFP, Wire Bond           | 160  |

## Excalibur Devices

Table 22 lists the device name, package type, and number of pins for the Excalibur device family.



The package type entries with “Option #” refer to instances where multiple package options exist for a given package type and pin count. The option number identifies the specific type used by the corresponding device density.

**Table 22.** Excalibur Devices

| Device | Package                                   | Pins |
|--------|---|------|
| EPXA1  | FBGA, Wire Bond, Option 2                 | 484  |
|        | Dual-Piece Lid: FBGA, Flip Chip, Option 1 | 672  |
| EPXA4  | Dual-Piece Lid: FBGA, Flip Chip, Option 1 | 672  |
|        | Dual-Piece Lid: FBGA, Flip Chip, Option 1 | 1020 |
| EPXA10 | Dual-Piece Lid: FBGA, Flip Chip, Option 1 | 1020 |

## Configuration Devices

Table 23 lists the device name, package type, and number of pins for the Configuration device family.



The package type entries with “Option #” refer to instances where multiple package options exist for a given package type and pin count. The option number identifies the specific type used by the corresponding device density.

**Table 23.** Configuration Devices

| Device  | Package         | Pins |
|---------|-----------------|------|
| EPC1    | PDIP, Wire Bond | 8    |
|         | PLCC, Wire Bond | 20   |
| EPC2    | PLCC, Wire Bond | 20   |
|         | TQFP, Wire Bond | 32   |
| EPC1064 | PDIP, Wire Bond | 8    |
|         | PLCC, Wire Bond | 20   |
| EPC1213 | PDIP, Wire Bond | 8    |
|         | PLCC, Wire Bond | 20   |
| EPC1441 | PDIP, Wire Bond | 8    |
|         | PLCC, Wire Bond | 20   |
|         | TQFP, Wire Bond | 32   |

## Enhanced Configuration Devices

Table 24 lists the device name, package type, and number of pins for the Enhanced configuration device family.



The package type entries with “Option #” refer to instances where multiple package options exist for a given package type and pin count. The option number identifies the specific type used by the corresponding device density.

**Table 24.** Enhanced Configuration Devices

| Device | Package         | Pins |
|--------|-----------------|------|
| EPC4   | PQFP, Wire Bond | 100  |
| EPC8   | PQFP, Wire Bond | 100  |
| EPC16  | UBGA, Wire Bond | 88   |
|        | PQFP, Wire Bond | 100  |

## Thermal Resistance

Altera follows JEDEC JESD51 series standards to provide thermal resistances. The purpose of the JESD51 standards is to compare the thermal performance of various packages under standardized test conditions. While standardized thermal resistances can help compare the relative thermal performance of different packages, they cannot apply directly to the many specific applications because JESD51 test conditions may not match a specific application. Several factors affect the thermal performance of a device in a user's application. These include power dissipation in the component; airflow velocity, direction and turbulence level; power in adjacent components; two-sided vs. one-sided active component mounting; printed circuit board (PCB) orientation & construction; and adjacent boards and their power dissipation. It may be necessary to test or model specific applications. This testing and modeling of a component user's specific applications is the user's responsibility.

Table 26 through Table 43 provide  $\theta_{JA}$  (junction-to-ambient thermal resistance) and  $\theta_{JC}$  (junction-to-case thermal resistance) values for the Altera device families. Altera reserves the right to make changes to thermal resistances without notice in the future.

Table 25 lists the mature Altera devices and the associated table locations.

**Table 25.** Thermal Resistance

| Altera Device         | Table Location  |
|-----------------------|---|
| Arria series FPGAs    | ■ Arria GX Devices: Table 26 on page 24   |
| Stratix series FPGAs  | ■ Stratix II Devices: Table 27 on page 25<br>■ Stratix Devices: Table 28 on page 26   |
| Cyclone series FPGAs  | ■ Cyclone II Devices: Table 29 on page 27<br>■ Cyclone Devices: Table 30 on page 28   |
| MAX series CPLDs      | ■ MAX 9000 Devices: Table 31 on page 29<br>■ MAX 7000 Devices: Table 32 on page 30<br>■ MAX 3000A Devices: Table 33 on page 33  |
| HardCopy series ASICs | ■ HardCopy II Devices: Table 34 on page 34<br>■ HardCopy Devices: Table 35 on page 34   |
| APEX series FPGAs     | ■ APEX II Devices: Table 36 on page 35<br>■ APEX 20K: Table 37 on page 36   |
| ACEX 1K FPGAs         | ACEX 1K Devices: Table 38 on page 38  |
| Mercury FPGAs         | Mercury Devices: Table 39 on page 39  |
| FLEX series FPGAs     | ■ FLEX 10K Devices: Table 40 on page 39<br>■ FLEX 8000 Devices: Table 41 on page 41<br>■ FLEX 6000 Devices: Table 42 on page 42 |
| Excalibur FPGAs       | Excalibur Devices: Table 43 on page 43  |

Altera is transitioning to an industry-standard copper lid for its thermally enhanced BGA and thermally enhanced Flip Chip FBGA package offerings.

 For more information, refer to *Process Change Notice PCN0214*.

This change affects the APEX 20KE, APEX 20KC, APEX II, Mercury, and Excalibur device families. Therefore, two thermal resistance specifications are provided for devices affected by this change. The older packages are identified as using the aluminum silicon carbide (AlSiC) lid, while the newer packages are identified as using the copper (Cu) lid.

Thermally enhanced BGA and thermally enhanced Flip Chip FBGA packages offered in the newer Altera families, including Stratix and Stratix GX, were introduced using an industry-standard Cu lid. Therefore, these device specifications include only a single thermal resistance specification.



Contact Altera if you need typical +/- values of A dimensions for thermal analysis. The max numbers are provided for physical layout.

## Arria Series Devices Thermal Resistance

Table 26 provides thermal resistance values for Arria series devices.

### Arria GX Devices

Table 26 lists the thermal resistance of Arria GX devices.

**Table 26.** Thermal Resistance of Arria GX Devices

| Device   | Package | Pin Count | $\theta_{JA}$<br>(° C/W)<br>Still Air | $\theta_{JA}$ (° C/W)<br>100 ft./min. | $\theta_{JA}$ (° C/W)<br>200 ft./min. | $\theta_{JA}$<br>(° C/W)<br>400 ft./min. | $\theta_{JC}$<br>(° C/W) | $\theta_{JB}$<br>(° C/W) |
|----------|---------|-----------|---------------------------------------|---------------------------------------|---------------------------------------|--|--------------------------|--------------------------|
| EP1AGX20 | FBGA    | 484       | 12.8                                  | 10.3                                  | 8.7                                   | 7.5                                      | 0.3                      | 3.1                      |
|          | FBGA    | 780       | 11.1                                  | 8.6                                   | 7.2                                   | 6.0                                      | 0.2                      | 3.1                      |
| EP1AGX35 | FBGA    | 484       | 12.8                                  | 10.3                                  | 8.7                                   | 7.5                                      | 0.3                      | 3.1                      |
|          | FBGA    | 780       | 11.1                                  | 8.6                                   | 7.2                                   | 6.0                                      | 0.2                      | 3.1                      |
| EP1AGX50 | FBGA    | 484       | 12.7                                  | 10.2                                  | 8.6                                   | 7.3                                      | 0.2                      | 2.9                      |
|          | FBGA    | 780       | 10.9                                  | 8.4                                   | 6.9                                   | 5.8                                      | 0.2                      | 2.9                      |
|          | FBGA    | 1152      | 9.9                                   | 7.5                                   | 6.1                                   | 5.0                                      | 0.2                      | 2.5                      |
| EP1AGX60 | FBGA    | 484       | 12.7                                  | 10.2                                  | 8.6                                   | 7.3                                      | 0.2                      | 2.9                      |
|          | FBGA    | 780       | 10.9                                  | 8.4                                   | 6.9                                   | 5.8                                      | 0.2                      | 2.8                      |
|          | FBGA    | 1152      | 9.9                                   | 7.5                                   | 6.1                                   | 5.0                                      | 0.2                      | 2.5                      |
| EP1AGX90 | FBGA    | 1152      | 9.6                                   | 7.3                                   | 5.9                                   | 4.9                                      | 0.1                      | 2.3                      |

## Stratix Series Devices Thermal Resistance

Table 27 to Table 28 provide thermal resistance values for Stratix series devices.

### Stratix II Devices

Table 27 lists the thermal resistance of Stratix II devices.

**Table 27.** Thermal Resistance of Stratix II Devices (Part 1 of 2)

| Device   | Package         | Pin Count | $\theta_{JC}$ ( $^{\circ}$ C/W) | $\theta_{JA}$ ( $^{\circ}$ C/W) Still Air | $\theta_{JA}$ ( $^{\circ}$ C/W) 100 ft./min. | $\theta_{JA}$ ( $^{\circ}$ C/W) 200 ft./min. | $\theta_{JA}$ ( $^{\circ}$ C/W) 400 ft./min. | $\theta_{JB}$ ( $^{\circ}$ C/W) |
|----------|-----------------|-----------|---------------------------------|---|--|--|--|---------------------------------|
| EP2S15   | FBGA, Flip Chip | 484       | 0.4                             | 13.1                                      | 11.1   | 9.6  | 8.3  | 4.2                             |
|          | FBGA, Flip Chip | 672       | 0.4                             | 12.2                                      | 10.2   | 8.8  | 7.6  | 4.1                             |
| EP2S30   | FBGA, Flip Chip | 484       | 0.2                             | 12.6                                      | 10.6   | 9.1  | 7.9  | 3.7                             |
|          | FBGA, Flip Chip | 672       | 0.2                             | 11.7                                      | 9.7  | 8.3  | 7.1  | 3.4                             |
| EP2S60   | FBGA, Flip Chip | 484       | 0.1                             | 12.3                                      | 10.3   | 8.8  | 7.5  | 3.4                             |
|          | FBGA, Flip Chip | 672       | 0.1                             | 11.4                                      | 9.4  | 7.8  | 6.7  | 3.0                             |
|          | FBGA, Flip Chip | 1020      | 0.1                             | 10.4                                      | 8.4  | 7.0  | 5.9  | 2.7                             |
| EP2S90   | HBGA, Flip Chip | 484       | 0.1                             | 12.0                                      | 9.9  | 8.3  | 7.1  | 3.7                             |
|          | FBGA, Flip Chip | 780       | 0.1                             | 10.8                                      | 8.8  | 7.3  | 6.1  | 2.6                             |
|          | FBGA, Flip Chip | 1020      | 0.1                             | 10.2                                      | 8.2  | 6.8  | 5.7  | 2.4                             |
|          | FBGA, Flip Chip | 1508      | 0.1                             | 9.3                                       | 7.4  | 6.1  | 5.0  | 2.2                             |
| EP2S130  | FBGA, Flip Chip | 780       | 0.1                             | 10.1                                      | 8.7  | 7.2  | 6.0  | 2.4                             |
|          | FBGA, Flip Chip | 1020      | 0.1                             | 9.5                                       | 8.1  | 6.7  | 5.5  | 2.2                             |
|          | FBGA, Flip Chip | 1508      | 0.1                             | 8.6                                       | 7.3  | 6.0  | 4.8  | 2.1                             |
| EP2S180  | FBGA, Flip Chip | 1020      | 0.1                             | 9.0                                       | 7.9  | 6.5  | 5.4  | 2.1                             |
|          | FBGA, Flip Chip | 1508      | 0.1                             | 8.1                                       | 7.1  | 5.8  | 4.7  | 1.9                             |
| EP2SGX30 | FBGA, Flip Chip | 780       | 0.2                             | 11.1                                      | 8.6  | 7.2  | 6.0  | 3.1                             |
| EP2SGX60 | FBGA, Flip Chip | 780       | 0.2                             | 10.9                                      | 8.4  | 6.9  | 5.8  | 2.8                             |
|          | FBGA, Flip Chip | 1152      | 0.2                             | 9.9                                       | 7.5  | 6.1  | 5.0  | 2.5                             |

**Table 27.** Thermal Resistance of Stratix II Devices (Part 2 of 2)

| Device    | Package         | Pin Count | $\theta_{JC}$ ( $^{\circ}$ C/W) | $\theta_{JA}$ ( $^{\circ}$ C/W) Still Air | $\theta_{JA}$ ( $^{\circ}$ C/W) 100 ft./min. | $\theta_{JA}$ ( $^{\circ}$ C/W) 200 ft./min. | $\theta_{JA}$ ( $^{\circ}$ C/W) 400 ft./min. | $\theta_{JB}$ ( $^{\circ}$ C/W) |
|-----------|-----------------|-----------|---------------------------------|---|--|--|--|---------------------------------|
| EP2SGX90  | FBGA, Flip Chip | 1152      | 0.1                             | 9.6                                       | 7.3  | 5.9  | 4.9  | 2.3                             |
|           | FBGA, Flip Chip | 1508      | 0.1                             | 9.0                                       | 6.7  | 5.4  | 4.4  | 1.9                             |
| EP2SGX130 | FBGA, Flip Chip | 1508      | 0.1                             | 8.3                                       | 6.6  | 5.3  | 4.3  | 1.8                             |

**Stratix Devices**

Table 28 lists the thermal resistance of Stratix devices.

**Table 28.** Thermal Resistance of Stratix Devices (Part 1 of 2)

| Device                 | Package         | Pin Count | $\theta_{JC}$ ( $^{\circ}$ C/W) | $\theta_{JA}$ ( $^{\circ}$ C/W) Still Air | $\theta_{JA}$ ( $^{\circ}$ C/W) 100 ft./min. | $\theta_{JA}$ ( $^{\circ}$ C/W) 200 ft./min. | $\theta_{JA}$ ( $^{\circ}$ C/W) 400 ft./min. |
|------------------------|-----------------|-----------|---------------------------------|---|--|--|--|
| EP1SGX10C<br>EP1SGX10D | FBGA, Flip Chip | 672       | 0.4                             | 11.1                                      | 9.1  | 7.7  | 6.5  |
| EP1SGX25C<br>EP1SGX25D | FBGA, Flip Chip | 672       | 0.2                             | 10.8                                      | 8.8  | 7.4  | 6.2  |
| EP1SGX25D<br>EP1SGX25F | FBGA, Flip Chip | 1020      | 0.2                             | 9.9                                       | 7.9  | 6.5  | 5.4  |
| EP1SGX40D<br>EP1SGX40G | FBGA, Flip Chip | 1020      | 0.2                             | 9.8                                       | 7.7  | 6.4  | 5.3  |
| EP1S10                 | FBGA, Flip Chip | 484       | 0.4                             | 11.9                                      | 9.8  | 8.4  | 7.2  |
|                        | BGA             | 672       | 3.2                             | 16.8                                      | 13.7   | 11.9   | 10.5   |
|                        | FBGA            | 672       | 3.4                             | 17.2                                      | 14.0   | 12.2   | 10.8   |
|                        | FBGA, Flip Chip | 780       | 0.4                             | 10.9                                      | 8.8  | 7.4  | 6.3  |
| EP1S20                 | FBGA, Flip Chip | 484       | 0.3                             | 11.8                                      | 9.7  | 8.3  | 7.1  |
|                        | BGA             | 672       | 2.5                             | 15.5                                      | 12.4   | 10.7   | 9.3  |
|                        | FBGA            | 672       | 2.7                             | 16.0                                      | 12.8   | 11.0   | 9.6  |
|                        | FBGA, Flip Chip | 780       | 0.3                             | 10.7                                      | 8.6  | 7.2  | 6.1  |
| EP1S25                 | BGA             | 672       | 2.2                             | 14.8                                      | 11.7   | 10.0   | 8.7  |
|                        | FBGA            | 672       | 2.3                             | 15.3                                      | 12   | 10.4   | 9.0  |
|                        | FBGA, Flip Chip | 780       | 0.3                             | 10.5                                      | 8.5  | 7.1  | 6.0  |
|                        | FBGA, Flip Chip | 1020      | 0.3                             | 10.0                                      | 8.0  | 6.6  | 5.5  |

**Table 28.** Thermal Resistance of Stratix Devices (Part 2 of 2)

| Device | Package            | Pin Count | $\theta_{JC}$ ( $^{\circ}C/W$ ) | $\theta_{JA}$ ( $^{\circ}C/W$ )<br>Still Air | $\theta_{JA}$ ( $^{\circ}C/W$ )<br>100 ft./min. | $\theta_{JA}$ ( $^{\circ}C/W$ )<br>200 ft./min. | $\theta_{JA}$ ( $^{\circ}C/W$ )<br>400 ft./min. |
|--------|--------------------|-----------|---------------------------------|--|---|---|---|
| EP1S30 | FBGA,<br>Flip Chip | 780       | 0.2                             | 10.4   | 8.4   | 7.0   | 5.9   |
|        | BGA,<br>Flip Chip  | 956       | 0.2                             | 9.1  | 7.1   | 5.8   | 4.8   |
|        | FBGA,<br>Flip Chip | 1020      | 0.2                             | 9.9  | 7.9   | 6.5   | 5.4   |
| EP1S40 | FBGA,<br>Flip Chip | 780       | 0.2                             | 10.4   | 8.3   | 6.9   | 5.8   |
|        | BGA,<br>Flip Chip  | 956       | 0.2                             | 9.0  | 7.0   | 5.7   | 4.7   |
|        | FBGA,<br>Flip Chip | 1020      | 0.2                             | 9.8  | 7.8   | 6.4   | 5.3   |
|        | FBGA,<br>Flip Chip | 1508      | 0.2                             | 9.1  | 7.1   | 5.8   | 4.7   |
| EP1S60 | BGA,<br>Flip Chip  | 956       | 0.1                             | 8.9  | 6.9   | 5.6   | 4.6   |
|        | FBGA,<br>Flip Chip | 1020      | 0.1                             | 9.7  | 7.7   | 6.3   | 5.2   |
|        | FBGA,<br>Flip Chip | 1508      | 0.1                             | 8.9  | 7.0   | 5.6   | 4.6   |
| EP1S80 | BGA,<br>Flip Chip  | 956       | 0.1                             | 8.8  | 6.8   | 5.5   | 4.5   |
|        | FBGA,<br>Flip Chip | 1020      | 0.1                             | 9.6  | 7.6   | 6.2   | 5.1   |
|        | FBGA,<br>Flip Chip | 1508      | 0.1                             | 8.8  | 6.9   | 5.5   | 4.5   |

## Cyclone Series Devices Thermal Resistance

Table 29 to Table 30 provide thermal resistance values for Cyclone series devices.

### Cyclone II Devices

Table 29 lists the thermal resistance of Cyclone II devices.

**Table 29.** Thermal Resistance of Cyclone II Devices (Part 1 of 2)

| Device | Package            | Pin Count | $\theta_{JC}$ ( $^{\circ}C/W$ ) | $\theta_{JA}$ ( $^{\circ}C/W$ )<br>Still Air | $\theta_{JA}$ ( $^{\circ}C/W$ )<br>100 ft./min. | $\theta_{JA}$ ( $^{\circ}C/W$ )<br>200 ft./min. | $\theta_{JA}$ ( $^{\circ}C/W$ )<br>400 ft./min. |
|--------|--------------------|-----------|---------------------------------|--|---|---|---|
| EP2C5  | TQFP,<br>Wire Bond | 144       | 10.0                            | 31.0   | 29.3  | 27.9  | 25.5  |
|        | PQFP,<br>Wire Bond | 208       | 5.5                             | 30.4   | 29.2  | 27.3  | 22.3  |
|        | FBGA,<br>Wire Bond | 256       | 8.7                             | 30.2   | 26.1  | 23.6  | 21.7  |

**Table 29.** Thermal Resistance of Cyclone II Devices (Part 2 of 2)

| Device | Package            | Pin Count | $\theta_{JC}$ ( $^{\circ}$ C/W) | $\theta_{JA}$ ( $^{\circ}$ C/W)<br>Still Air | $\theta_{JA}$ ( $^{\circ}$ C/W)<br>100 ft./min. | $\theta_{JA}$ ( $^{\circ}$ C/W)<br>200 ft./min. | $\theta_{JA}$ ( $^{\circ}$ C/W)<br>400 ft./min. |
|--------|--------------------|-----------|---------------------------------|--|---|---|---|
| EP2C8  | TQFP,<br>Wire Bond | 144       | 9.9                             | 29.8   | 28.3  | 26.9  | 24.9  |
|        | PQFP,<br>Wire Bond | 208       | 5.4                             | 30.2   | 28.8  | 26.9  | 21.7  |
|        | FBGA,<br>Wire Bond | 256       | 7.1                             | 27.0   | 23.0  | 20.5  | 18.5  |
| EP2C15 | FBGA,<br>Wire Bond | 256       | 5.5                             | 24.2   | 20.0  | 17.8  | 16.0  |
|        | FBGA,<br>Wire Bond | 484       | 4.2                             | 21.0   | 17.0  | 14.8  | 13.1  |
| EP2C20 | PQFP,<br>Wire Bond | 240       | 4.2                             | 26.6   | 24.0  | 21.4  | 17.4  |
|        | FBGA,<br>Wire Bond | 256       | 5.5                             | 24.2   | 20.0  | 17.8  | 16.0  |
|        | FBGA,<br>Wire Bond | 484       | 4.2                             | 21.0   | 17.0  | 14.8  | 13.1  |
| EP2C35 | FBGA,<br>Wire Bond | 484       | 3.3                             | 19.4   | 15.4  | 13.3  | 11.7  |
|        | UBGA,<br>Wire Bond | 484       | 5.0                             | 20.6   | 16.6  | 14.5  | 12.8  |
|        | FBGA,<br>Wire Bond | 672       | 3.1                             | 18.6   | 14.6  | 12.6  | 11.1  |
| EP2C50 | FBGA,<br>Wire Bond | 484       | 2.8                             | 18.4   | 14.4  | 12.4  | 10.9  |
|        | UBGA,<br>Wire Bond | 484       | 4.4                             | 19.6   | 15.6  | 13.6  | 11.9  |
|        | FBGA,<br>Wire Bond | 672       | 2.6                             | 17.7   | 13.7  | 11.8  | 10.2  |
| EP2C70 | FBGA,<br>Wire Bond | 672       | 2.2                             | 16.9   | 13.0  | 11.1  | 9.7   |
|        | FBGA,<br>Wire Bond | 896       | 2.1                             | 16.3   | 11.9  | 10.5  | 9.1   |

### Cyclone Devices

Table 30 lists the thermal resistance of Cyclone devices.

**Table 30.** Thermal Resistance of Cyclone Devices (Part 1 of 2)

| Device | Package | Pin Count | $\theta_{JC}$ ( $^{\circ}$ C/W) | $\theta_{JA}$ ( $^{\circ}$ C/W)<br>Still Air | $\theta_{JA}$ ( $^{\circ}$ C/W)<br>100 ft./min. | $\theta_{JA}$ ( $^{\circ}$ C/W)<br>200 ft./min. | $\theta_{JA}$ ( $^{\circ}$ C/W)<br>400 ft./min. |
|--------|---------|-----------|---------------------------------|--|---|---|---|
| EP1C3  | TQFP    | 100       | 11.0                            | 37.5   | 35.4  | 33.4  | 29.8  |
|        | TQFP    | 144       | 10.0                            | 31.1   | 29.4  | 27.9  | 25.5  |
| EP1C6  | TQFP    | 144       | 9.8                             | 29.4   | 28.0  | 26.7  | 24.7  |
|        | PQFP    | 240       | 4.3                             | 27.2   | 24.7  | 22.1  | 17.8  |
|        | FBGA    | 256       | 8.8                             | 28.7   | 24.5  | 22.3  | 20.5  |

**Table 30.** Thermal Resistance of Cyclone Devices (Part 2 of 2)

| Device | Package | Pin Count | $\theta_{JC}$ (° C/W) | $\theta_{JA}$ (° C/W)<br>Still Air | $\theta_{JA}$ (° C/W)<br>100 ft./min. | $\theta_{JA}$ (° C/W)<br>200 ft./min. | $\theta_{JA}$ (° C/W)<br>400 ft./min. |
|--------|---------|-----------|-----------------------|------------------------------------|---------------------------------------|---------------------------------------|---------------------------------------|
| EP1C12 | PQFP    | 240       | 4.0                   | 26.0                               | 23.4                                  | 20.8                                  | 17.1                                  |
|        | FBGA    | 256       | 6.6                   | 24.3                               | 20.2                                  | 18.1                                  | 16.4                                  |
|        | FBGA    | 324       | 6.1                   | 23.0                               | 19.8                                  | 17.7                                  | 16.1                                  |
| EP1C20 | FBGA    | 324       | 5.0                   | 21.0                               | 17.7                                  | 15.6                                  | 14.1                                  |
|        | FBGA    | 400       | 4.7                   | 20.7                               | 17.5                                  | 15.5                                  | 13.9                                  |

## MAX Series Devices Thermal Resistance

Table 31 through Table 33 provide thermal resistance values for MAX series devices.

### MAX 9000 Devices

Table 31 lists the thermal resistance of MAX 9000 devices.

**Table 31.** Thermal Resistance of MAX 9000 Devices

| Device   | Package | Pin Count | $\theta_{JC}$ (° C/W) | $\theta_{JA}$ (° C/W)<br>Still Air | $\theta_{JA}$ (° C/W)<br>100 ft./min. | $\theta_{JA}$ (° C/W)<br>200 ft./min. | $\theta_{JA}$ (° C/W)<br>400 ft./min. |
|----------|---------|-----------|-----------------------|------------------------------------|---------------------------------------|---------------------------------------|---------------------------------------|
| EPM9320  | PLCC    | 84        | 9.0                   | 29.0                               | 27.0                                  | 25.0                                  | 23.0                                  |
|          | RQFP    | 208       | 1.0                   | 17.0                               | 16.0                                  | 15.0                                  | 13.0                                  |
|          | PGA     | 280       | 2.0                   | 14.0                               | 10.0                                  | 7.0                                   | 5.0                                   |
|          | BGA     | 356       | 2.0                   | 14.0                               | 12.0                                  | 11.0                                  | 10.0                                  |
| EPM9320A | PLCC    | 84        | 9.0                   | 29.0                               | 27.0                                  | 26.0                                  | 23.0                                  |
|          | RQFP    | 208       | 2.0                   | 17.0                               | 16.0                                  | 15.0                                  | 13.0                                  |
|          | BGA     | 356       | 1.0                   | 12.0                               | 11.0                                  | 10.0                                  | 9.0                                   |
| EPM9400  | PLCC    | 84        | 9.0                   | 29.0                               | 27.0                                  | 25.0                                  | 23.0                                  |
|          | RQFP    | 208       | 1.0                   | 17.0                               | 16.0                                  | 15.0                                  | 13.0                                  |
|          | RQFP    | 240       | 1.0                   | 14.0                               | 12.0                                  | 11.0                                  | 10.0                                  |
| EPM9480  | RQFP    | 208       | 1.0                   | 17.0                               | 16.0                                  | 15.0                                  | 12.0                                  |
|          | RQFP    | 240       | 1.0                   | 12.0                               | 11.0                                  | 10.0                                  | 9.0                                   |
| EPM9560  | RQFP    | 208       | 1.0                   | 17.0                               | 16.0                                  | 15.0                                  | 12.0                                  |
|          | RQFP    | 240       | 1.0                   | 12.0                               | 11.0                                  | 10.0                                  | 9.0                                   |
|          | BGA     | 356       | 1.0                   | 12.0                               | 11.0                                  | 10.0                                  | 9.0                                   |
| EPM9560A | RQFP    | 208       | 1.0                   | 17.0                               | 16.0                                  | 15.0                                  | 12.0                                  |
|          | RQFP    | 240       | 1.0                   | 11.0                               | 10.0                                  | 9.0                                   | 8.0                                   |
|          | BGA     | 356       | 1.0                   | 12.0                               | 11.0                                  | 10.0                                  | 9.0                                   |

**MAX 7000 Devices**

Table 32 lists the thermal resistance of MAX 7000 devices.

**Table 32.** Thermal Resistance of MAX 7000 Devices (Part 1 of 3)

| Device                | Package | Pin Count | $\theta_{JC}$ (° C/W) | $\theta_{JA}$ (° C/W)<br>Still Air | $\theta_{JA}$ (° C/W)<br>100 ft./min. | $\theta_{JA}$ (° C/W)<br>200 ft./min. | $\theta_{JA}$ (° C/W)<br>400 ft./min. |
|-----------------------|---------|-----------|-----------------------|------------------------------------|---------------------------------------|---------------------------------------|---------------------------------------|
| EPM7032               | PLCC    | 44        | 10.0                  | 33.0                               | 31.0                                  | 30.0                                  | 27.0                                  |
|                       | PQFP    |           | 15.0                  | 48.0                               | 46.0                                  | 45.0                                  | 42.0                                  |
|                       | TQFP    |           | 14.0                  | 46.0                               | 44.0                                  | 43.0                                  | 40.0                                  |
| EPM7032B              | PLCC    | 44        | 10.0                  | 33.0                               | 31.0                                  | 30.0                                  | 27.0                                  |
|                       | TQFP    |           | 14.0                  | 46.0                               | 44.0                                  | 43.0                                  | 40.0                                  |
|                       | UBGA    | 49        | 23.0                  | 69.0                               | 67.0                                  | 66.0                                  | 62.0                                  |
| EPM7032S              | PLCC    | 44        | 10.0                  | 33.0                               | 31.0                                  | 30.0                                  | 27.0                                  |
|                       | TQFP    |           | 14.0                  | 46.0                               | 44.0                                  | 43.0                                  | 40.0                                  |
| EPM7032V              | PLCC    | 44        | 9.0                   | 31.0                               | 30.0                                  | 28.0                                  | 25.0                                  |
|                       | TQFP    |           | 14.0                  | 45.0                               | 44.0                                  | 42.0                                  | 39.0                                  |
| EPM7032AE             | PLCC    | 44        | 9.0                   | 31.0                               | 30.0                                  | 28.0                                  | 25.0                                  |
|                       | TQFP    |           | 14.0                  | 46.0                               | 45.0                                  | 43.0                                  | 40.0                                  |
| EPM7064S              | PLCC    | 44        | 9.0                   | 31.0                               | 30.0                                  | 28.0                                  | 25.0                                  |
|                       | TQFP    |           | 14.0                  | 46.0                               | 44.0                                  | 43.0                                  | 40.0                                  |
|                       | PLCC    | 84        | 9.0                   | 28.0                               | 26.0                                  | 25.0                                  | 23.0                                  |
|                       | TQFP    | 100       | 11.0                  | 39.0                               | 37.0                                  | 35.0                                  | 32.0                                  |
| EPM7064               | PLCC    | 44        | 9.0                   | 31.0                               | 30.0                                  | 28.0                                  | 25.0                                  |
|                       | TQFP    |           | 13.0                  | 44.0                               | 43.0                                  | 41.0                                  | 38.0                                  |
|                       | PLCC    | 84        | 9.0                   | 28.0                               | 26.0                                  | 25.0                                  | 22.0                                  |
|                       | PQFP    | 100       | 6.0                   | 33.0                               | 32.0                                  | 31.0                                  | 30.0                                  |
| EPM7064AE<br>EPM7064B | PLCC    | 44        | 9.0                   | 31.0                               | 30.0                                  | 28.0                                  | 25.0                                  |
|                       | TQFP    |           | 14.0                  | 46.0                               | 45.0                                  | 43.0                                  | 40.0                                  |
|                       | UBGA    | 49        | 23.0                  | 56.0                               | 53.0                                  | 51.0                                  | 47.0                                  |
|                       | TQFP    | 100       | 12.0                  | 39.0                               | 37.0                                  | 35.0                                  | 31.0                                  |
|                       | FBGA    |           | 21.0                  | 49.0                               | 47.0                                  | 44.0                                  | 40.0                                  |
| EPM7096               | PLCC    | 68        | 9.0                   | 29.0                               | 27.0                                  | 26.0                                  | 23.0                                  |
|                       | PLCC    | 84        | 9.0                   | 28.0                               | 26.0                                  | 24.0                                  | 22.0                                  |
| EPM7128A              | PLCC    | 84        | 9.0                   | 28.0                               | 26.0                                  | 25.0                                  | 22.0                                  |
|                       | TQFP    |           | 100                   | 11.0                               | 37.0                                  | 35.0                                  | 33.0                                  |
|                       | FBGA    | 18.0      |                       | 44.0                               | 42.0                                  | 39.0                                  | 35.0                                  |
|                       | TQFP    | 144       | 9.0                   | 31.0                               | 29.0                                  | 28.0                                  | 25.0                                  |
|                       | FBGA    | 256       | 12.0                  | 38.0                               | 36.0                                  | 34.0                                  | 31.0                                  |

**Table 32.** Thermal Resistance of MAX 7000 Devices (Part 2 of 3)

| Device    | Package | Pin Count | $\theta_{JC}$ (° C/W) | $\theta_{JA}$ (° C/W) Still Air | $\theta_{JA}$ (° C/W) 100 ft./min. | $\theta_{JA}$ (° C/W) 200 ft./min. | $\theta_{JA}$ (° C/W) 400 ft./min. |
|-----------|---------|-----------|-----------------------|---------------------------------|------------------------------------|------------------------------------|------------------------------------|
| EPM7128B  | UBGA    | 49        | 22.0                  | 53.0                            | 50.0                               | 48.0                               | 44.0                               |
|           | TQFP    | 100       | 11.0                  | 38.0                            | 36.0                               | 34.0                               | 31.0                               |
|           | FBGA    |           | 19.0                  | 46.0                            | 44.0                               | 41.0                               | 37.0                               |
|           | TQFP    | 144       | 9.0                   | 32.0                            | 30.0                               | 29.0                               | 26.0                               |
|           | UBGA    | 169       | 16.0                  | 44.0                            | 42.0                               | 39.0                               | 35.0                               |
|           | FBGA    | 256       | 13.0                  | 40.0                            | 38.0                               | 36.0                               | 33.0                               |
| EPM7128E  | PLCC    | 84        | 10.0                  | 29.0                            | 28.0                               | 26.0                               | 23.0                               |
|           | PQFP    | 100       | 6.0                   | 32.0                            | 31.0                               | 30.0                               | 29.0                               |
|           | PQFP    | 160       | 6.0                   | 32.0                            | 31.0                               | 30.0                               | 28.0                               |
| EPM7128S  | PLCC    | 84        | 10.0                  | 30.0                            | 28.0                               | 26.0                               | 23.0                               |
|           | TQFP    | 100       | 12.0                  | 38.0                            | 36.0                               | 34.0                               | 30.0                               |
|           | PQFP    |           | 10.0                  | 35.0                            | 34.0                               | 33.0                               | 32.0                               |
|           | PQFP    | 160       | 7.0                   | 33.0                            | 32.0                               | 31.0                               | 30.0                               |
| EPM7128AE | PLCC    | 84        | 11.0                  | 30.0                            | 28.0                               | 26.0                               | 23.0                               |
|           | TQFP    | 100       | 12.0                  | 38.0                            | 36.0                               | 34.0                               | 30.0                               |
|           | FBGA    |           | 14.0                  | 43.0                            | 40.0                               | 38.0                               | 37.0                               |
|           | TQFP    | 144       | 11.0                  | 33.0                            | 30.0                               | 28.0                               | 26.0                               |
|           | UBGA    | 169       | 14.0                  | 42.0                            | 40.0                               | 38.0                               | 36.0                               |
|           | FBGA    | 256       | 12.0                  | 39.0                            | 37.0                               | 35.0                               | 31.0                               |
| EPM7160E  | PLCC    | 84        | 10.0                  | 29.0                            | 28.0                               | 26.0                               | 23.0                               |
|           | PQFP    | 100       | 6.0                   | 32.0                            | 31.0                               | 30.0                               | 29.0                               |
|           | PQFP    | 160       | 6.0                   | 33.0                            | 32.0                               | 31.0                               | 30.0                               |
| EPM7160S  | PLCC    | 84        | 10.0                  | 35.0                            | 28.0                               | 26.0                               | 23.0                               |
|           | TQFP    | 100       | 12.0                  | 37.0                            | 35.0                               | 33.0                               | 30.0                               |
|           | PQFP    | 160       | 6.0                   | 33.0                            | 32.0                               | 31.0                               | 30.0                               |
| EPM7192S  | PQFP    | 160       | 6.0                   | 32.0                            | 31.0                               | 30.0                               | 29.0                               |
| EPM7192E  | PGA     | 160       | 6.0                   | 20.0                            | 13.0                               | 10.0                               | 8.0                                |
|           | PQFP    |           | 6.0                   | 32.0                            | 31.0                               | 30.0                               | 26.0                               |
| EPM7256A  | TQFP    | 100       | 9.0                   | 36.0                            | 34.0                               | 32.0                               | 30.0                               |
|           | TQFP    | 144       | 8.0                   | 32.0                            | 27.0                               | 25.0                               | 24.0                               |
|           | PQFP    | 208       | 5.0                   | 30.0                            | 28.0                               | 26.0                               | 21.0                               |
|           | FBGA    | 256       | 12.0                  | 34.0                            | 32.0                               | 29.0                               | 28.0                               |
| EPM7256B  | TQFP    | 100       | 12.0                  | 37.0                            | 35.0                               | 33.0                               | 30.0                               |
|           | TQFP    | 144       | 9.0                   | 33.0                            | 29.0                               | 27.0                               | 25.0                               |
|           | UBGA    | 169       | 13.0                  | 40.0                            | 38.0                               | 36.0                               | 34.0                               |
|           | PQFP    | 208       | 5.0                   | 31.0                            | 29.0                               | 27.0                               | 22.0                               |
|           | FBGA    | 256       | 9.0                   | 34.0                            | 32.0                               | 30.0                               | 28.0                               |

**Table 32.** Thermal Resistance of MAX 7000 Devices (Part 3 of 3)

| Device    | Package | Pin Count | $\theta_{JC}$ ( $^{\circ}C/W$ ) | $\theta_{JA}$ ( $^{\circ}C/W$ )<br>Still Air | $\theta_{JA}$ ( $^{\circ}C/W$ )<br>100 ft./min. | $\theta_{JA}$ ( $^{\circ}C/W$ )<br>200 ft./min. | $\theta_{JA}$ ( $^{\circ}C/W$ )<br>400 ft./min. |
|-----------|---------|-----------|---------------------------------|--|---|---|---|
| EPM7256E  | PGA     | 192       | 6.0                             | 20.0   | 13.0  | 10.0  | 8.0   |
|           | PQFP    | 160       | 6.0                             | 31.0   | 30.0  | 29.0  | 25.0  |
|           | RQFP    | 208       | 1.0                             | 17.0   | 16.0  | 15.0  | 13.0  |
| EPM7256S  | PQFP    | 208       | 5.0                             | 30.0   | 29.0  | 26.0  | 21.0  |
|           | RQFP    |           | 1.0                             | 18.0   | 17.0  | 16.0  | 15.0  |
| EPM7256AE | FBGA    | 100       | 13.0                            | 42.0   | 39.0  | 37.0  | 36.0  |
|           | TQFP    | 100       | 12.0                            | 37.0   | 35.0  | 33.0  | 30.0  |
|           | TQFP    | 144       | 9.0                             | 33.0   | 29.0  | 27.0  | 25.0  |
|           | PQFP    | 208       | 5.0                             | 31.0   | 29.0  | 27.0  | 22.0  |
|           | FBGA    | 256       | 9.0                             | 34.0   | 32.0  | 30.0  | 28.0  |
| EPM7512AE | TQFP    | 144       | 10.0                            | 32.0   | 27.0  | 25.0  | 23.0  |
|           | PQFP    | 208       | 5.0                             | 30.0   | 28.0  | 25.0  | 21.0  |
|           | BGA     | 256       | 1.2                             | 14.0   | 12.0  | 11.0  | 10.0  |
|           | FBGA    |           | 11.0                            | 32.0   | 30.0  | 28.0  | 22.0  |
| EPM7512B  | TQFP    | 144       | 10.0                            | 32.0   | 27.0  | 25.0  | 24.0  |
|           | UBGA    | 169       | 12.0                            | 35.0   | 33.0  | 31.0  | 30.0  |
|           | PQFP    | 208       | 5.0                             | 30.0   | 28.0  | 25.0  | 21.0  |
|           | BGA     | 256       | 1.2                             | 14.0   | 12.0  | 11.0  | 10.0  |
|           | FBGA    | 256       | 11.0                            | 32.0   | 30.0  | 28.0  | 27.0  |

## MAX 3000A Devices

Table 33 lists the thermal resistance of MAX 3000A devices.

**Table 33.** Thermal Resistance of MAX 3000A Devices

| Device   | Package | Pin Count | $\theta_{JC}$ (° C/W) | $\theta_{JA}$ (° C/W)<br>Still Air | $\theta_{JA}$ (° C/W)<br>100 ft./min. | $\theta_{JA}$ (° C/W)<br>200 ft./min. | $\theta_{JA}$ (° C/W)<br>400 ft./min. |
|----------|---------|-----------|-----------------------|------------------------------------|---------------------------------------|---------------------------------------|---------------------------------------|
| EPM3032A | TQFP    | 44        | 14.0                  | 46.0                               | 45.0                                  | 43.0                                  | 40.0                                  |
|          | PLCC    |           | 9.0                   | 31.0                               | 30.0                                  | 28.0                                  | 25.0                                  |
| EPM3064A | TQFP    | 44        | 14.0                  | 46.0                               | 45.0                                  | 43.0                                  | 40.0                                  |
|          | PLCC    |           | 9.0                   | 31.0                               | 30.0                                  | 28.0                                  | 25.0                                  |
|          | TQFP    | 100       | 12.0                  | 39.0                               | 37.0                                  | 35.0                                  | 31.0                                  |
| EPM3128A | TQFP    | 100       | 12.0                  | 38.0                               | 36.0                                  | 34.0                                  | 30.0                                  |
| EPM3256A | TQFP    | 144       | 9.0                   | 33.0                               | 29.0                                  | 27.0                                  | 25.0                                  |
|          | PQFP    | 208       | 5.0                   | 31.0                               | 29.0                                  | 27.0                                  | 22.0                                  |
| EPM3512A | PQFP    | 208       | 5.0                   | 30.0                               | 28.0                                  | 25.0                                  | 21.0                                  |
|          | FBGA    | 256       | 11.0                  | 32.0                               | 30.0                                  | 28.0                                  | 22.0                                  |

## HardCopy Series Devices Thermal Resistance

Table 34 to Table 35 provide thermal resistance values for HardCopy series devices.

**HardCopy II Devices**

Table 34 lists the thermal resistance of HardCopy II devices.

**Table 34.** Thermal Resistance of HardCopy II Devices

| Device | Package            | Pin Count | $\theta_{JC}$ ( $^{\circ}$ C/W) | $\theta_{JA}$ ( $^{\circ}$ C/W)<br>Still Air | $\theta_{JA}$ ( $^{\circ}$ C/W)<br>100 ft./min. | $\theta_{JA}$ ( $^{\circ}$ C/W)<br>200 ft./min. | $\theta_{JA}$ ( $^{\circ}$ C/W)<br>400 ft./min. | $\theta_{JB}$ ( $^{\circ}$ C/W) |
|--------|--------------------|-----------|---------------------------------|--|---|---|---|---------------------------------|
| HC210  | FBGA,<br>Wire Bond | 484       | 5.5                             | 21.3   | 17.4  | 15.3  | 13.8  | 9.6                             |
| HC220  | FBGA,<br>Flip Chip | 672       | 0.5                             | 12.1   | 9.9   | 8.3   | 7.1   | 3.6                             |
|        | FBGA,<br>Flip Chip | 780       | 0.5                             | 11.7   | 9.5   | 8.0   | 6.8   | 3.5                             |
| HC230  | FBGA,<br>Flip Chip | 1020      | 0.3                             | 10.8   | 8.6   | 7.1   | 6.0   | 2.9                             |
| HC240  | FBGA,<br>Flip Chip | 1020      | 0.2                             | 10.6   | 8.4   | 6.9   | 5.8   | 2.7                             |
|        | FBGA,<br>Flip Chip | 1508      | 0.2                             | 9.7  | 7.5   | 6.1   | 5.0   | 2.6                             |

**HardCopy Devices**

Table 35 lists the thermal resistance of HardCopy devices.

**Table 35.** Thermal Resistance of HardCopy Devices

| Device   | Package         | Pin Count | $\theta_{JC}$ ( $^{\circ}$ C/W) | $\theta_{JA}$ ( $^{\circ}$ C/W)<br>Still Air | $\theta_{JA}$ ( $^{\circ}$ C/W)<br>100 ft./min. | $\theta_{JA}$ ( $^{\circ}$ C/W)<br>200 ft./min. | $\theta_{JA}$ ( $^{\circ}$ C/W)<br>400 ft./min. |
|----------|-----------------|-----------|---------------------------------|--|---|---|---|
| HC20K400 | BGA, Flip Chip  | 652       | 0.5                             | 9.1  | 7.9   | 6.4   | 5.3   |
| HC20K600 | FBGA, Flip Chip | 672       | 1.0                             | 13.0   | 10.2  | 8.6   | 7.3   |
| HC1S25   | FBGA, Wire Bond | 672       | 3.7                             | 19.7   | 15.8  | 13.9  | 12.4  |
|          | BGA, Wire Bond  |           | 3.4                             | 19.3   | 15.6  | 13.8  | 12.3  |
| HC1S30   | FBGA, Flip Chip | 780       | 0.4                             | 10.9   | 8.8   | 7.4   | 6.3   |
| HC1S40   | FBGA, Flip Chip | 780       | 0.4                             | 10.9   | 8.8   | 7.4   | 6.3   |
| HC1S60   | FBGA, Flip Chip | 1020      | 0.3                             | 10.3   | 8.54  | 7.0   | 5.8   |
| HC1S80   | FBGA, Flip Chip | 1020      | 0.3                             | 10.3   | 8.54  | 7.0   | 5.8   |

## APEX Series Devices Thermal Resistance

Table 36 to Table 37 list thermal resistance values for APEX series devices.

### APEX II Devices

Table 36 lists the thermal resistance of APEX II devices.

**Table 36.** Thermal Resistance of APEX II Devices

| Device | Package                     | Pin Count | $\theta_{JC}$ (° C/W) | $\theta_{JA}$ (° C/W)<br>Still Air | $\theta_{JA}$ (° C/W)<br>100 ft./min. | $\theta_{JA}$ (° C/W)<br>200 ft./min. | $\theta_{JA}$ (° C/W)<br>400 ft./min. |
|--------|-----------------------------|-----------|-----------------------|------------------------------------|---------------------------------------|---------------------------------------|---------------------------------------|
| EP2A15 | FBGA, Flip Chip (Cu lid)    | 672       | 0.2                   | 10.8                               | 8.8                                   | 7.4                                   | 6.2                                   |
|        | FBGA, Flip Chip (AlSiC lid) |           | 0.3                   | 11.6                               | 9.6                                   | 8.0                                   | 6.6                                   |
|        | BGA, Flip Chip (Cu lid)     | 724       | 0.2                   | 9.7                                | 7.7                                   | 6.4                                   | 5.3                                   |
|        | BGA, Flip Chip (AlSiC lid)  |           | 0.4                   | 10.0                               | 8.2                                   | 6.6                                   | 5.4                                   |
| EP2A25 | FBGA (Cu lid)               | 672       | 0.2                   | 10.7                               | 8.7                                   | 7.2                                   | 6.1                                   |
|        | FBGA, Flip Chip (AlSiC lid) |           | 0.3                   | 11.5                               | 9.6                                   | 8.0                                   | 6.6                                   |
|        | BGA, Flip Chip (Cu lid)     | 724       | 0.2                   | 9.6                                | 7.6                                   | 6.2                                   | 5.2                                   |
|        | BGA, Flip Chip (AlSiC lid)  |           | 0.3                   | 10.0                               | 8.2                                   | 6.6                                   | 5.4                                   |
|        | FBGA, Flip Chip (Cu lid)    | 1020      | 0.2                   | 9.8                                | 7.8                                   | 6.4                                   | 5.3                                   |
|        | FBGA, Flip Chip (AlSiC lid) |           | 0.3                   | 10.4                               | 8.5                                   | 6.9                                   | 5.7                                   |
| EP2A40 | FBGA, Flip Chip (Cu lid)    | 672       | 0.2                   | 10.0                               | 8.2                                   | 6.9                                   | 5.9                                   |
|        | FBGA, Flip Chip (AlSiC lid) |           | 0.2                   | 10.0                               | 8.2                                   | 6.9                                   | 5.9                                   |
|        | BGA, Flip Chip (Cu lid)     | 724       | 0.2                   | 9.5                                | 7.5                                   | 6.1                                   | 5.1                                   |
|        | BGA, Flip Chip (AlSiC lid)  |           | 0.2                   | 9.5                                | 7.5                                   | 6.1                                   | 5.1                                   |
|        | FBGA, Flip Chip (Cu lid)    | 1020      | 0.2                   | 9.7                                | 7.7                                   | 6.3                                   | 5.2                                   |
|        | FBGA, Flip Chip (AlSiC lid) |           | 0.2                   | 9.7                                | 7.7                                   | 6.3                                   | 5.2                                   |
| EP2A70 | BGA, Flip Chip (Cu lid)     | 724       | 0.1                   | 9.3                                | 7.3                                   | 6.0                                   | 4.9                                   |
|        | BGA, Flip Chip (AlSiC lid)  |           | 0.1                   | 10.0                               | 7.9                                   | 6.4                                   | 5.3                                   |
|        | FBGA, Flip Chip (Cu lid)    | 1508      | 0.1                   | 8.8                                | 6.8                                   | 5.5                                   | 4.5                                   |
|        | FBGA, Flip Chip (AlSiC lid) |           | 0.1                   | 9.3                                | 7.3                                   | 5.8                                   | 4.7                                   |

**APEX 20K Devices**

Table 37 lists the thermal resistance of APEX 20KE, 20KC, and 20K devices.

**Table 37.** Thermal Resistance of APEX 20KE, 20KC, and 20K Devices (Part 1 of 3)

| Device    | Package | Pin Count | $\theta_{JC}$ (° C/W) | $\theta_{JA}$ (° C/W)<br>Still Air | $\theta_{JA}$ (° C/W)<br>100 ft./min. | $\theta_{JA}$ (° C/W)<br>200 ft./min. | $\theta_{JA}$ (° C/W)<br>400 ft./min. |
|-----------|---------|-----------|-----------------------|------------------------------------|---------------------------------------|---------------------------------------|---------------------------------------|
| EP20K30E  | TQFP    | 144       | 8.0                   | 29.0                               | 28.0                                  | 26.0                                  | 25.0                                  |
|           | PQFP    | 208       | 5.0                   | 30.0                               | 29.0                                  | 27.0                                  | 22.0                                  |
|           | FBGA    | 144       | 14.0                  | 36.0                               | 34.0                                  | 32.0                                  | 29.0                                  |
|           | FBGA    | 324       | 9.0                   | 31.0                               | 29.0                                  | 28.0                                  | 25.0                                  |
| EP20K60E  | TQFP    | 144       | 7.0                   | 28.0                               | 26.0                                  | 25.0                                  | 24.0                                  |
|           | FBGA    | 144       | 11.0                  | 33.0                               | 32.0                                  | 30.0                                  | 27.0                                  |
|           | PQFP    | 208       | 5.0                   | 30.0                               | 28.0                                  | 26.0                                  | 21.0                                  |
|           | PQFP    | 240       | 4.0                   | 26.0                               | 24.0                                  | 21.0                                  | 17.0                                  |
|           | FBGA    | 324       | 7.0                   | 29.0                               | 28.0                                  | 26.0                                  | 24.0                                  |
|           | BGA     | 356       | 1.0                   | 12.0                               | 11.0                                  | 10.0                                  | 9.0                                   |
| EP20K100  | TQFP    | 144       | 7.0                   | 26.0                               | 25.0                                  | 24.0                                  | 23.0                                  |
|           | PQFP    | 208       | 5.0                   | 29.0                               | 27.0                                  | 25.0                                  | 20.0                                  |
|           | PQFP    | 240       | 4.0                   | 25.0                               | 23.0                                  | 20.0                                  | 17.0                                  |
|           | FBGA    | 324       | 6.0                   | 28.0                               | 26.0                                  | 25.0                                  | 23.0                                  |
|           | BGA     | 356       | 1.0                   | 12.0                               | 11.0                                  | 10.0                                  | 9.0                                   |
| EP20K100E | TQFP    | 144       | 7.0                   | 26.0                               | 25.0                                  | 24.0                                  | 23.0                                  |
|           | FBGA    | 144       | 9.0                   | 32.0                               | 30.0                                  | 29.0                                  | 26.0                                  |
|           | PQFP    | 208       | 5.0                   | 29.0                               | 27.0                                  | 25.0                                  | 20.0                                  |
|           | PQFP    | 240       | 4.0                   | 25.0                               | 23.0                                  | 20.0                                  | 17.0                                  |
|           | FBGA    | 324       | 6.0                   | 28.0                               | 26.0                                  | 25.0                                  | 23.0                                  |
|           | BGA     | 356       | 1.0                   | 12.0                               | 11.0                                  | 10.0                                  | 9.0                                   |
| EP20K160E | TQFP    | 144       | 6.0                   | 25.0                               | 24.0                                  | 23.0                                  | 22.0                                  |
|           | PQFP    | 208       | 5.0                   | 28.0                               | 26.0                                  | 23.0                                  | 19.0                                  |
|           | PQFP    | 240       | 4.0                   | 24.0                               | 21.0                                  | 19.0                                  | 16.0                                  |
|           | BGA     | 356       | 1.0                   | 12.0                               | 11.0                                  | 10.0                                  | 9.0                                   |
|           | FBGA    | 484       | 5.0                   | 24.0                               | 23.0                                  | 22.0                                  | 21.0                                  |
| EP20K200  | PQFP    | 208       | 4.0                   | 25.0                               | 23.0                                  | 20.0                                  | 17.0                                  |
|           | PQFP    | 240       | 3.0                   | 21.0                               | 19.0                                  | 17.0                                  | 15.0                                  |
|           | BGA     | 356       | 1.0                   | 12.0                               | 11.0                                  | 10.0                                  | 9.0                                   |
|           | FBGA    | 484       | 5.0                   | 22.0                               | 21.0                                  | 20.0                                  | 19.0                                  |
| EP20K200E | PQFP    | 208       | 4.0                   | 25.0                               | 23.0                                  | 20.0                                  | 17.0                                  |
|           | PQFP    | 240       | 3.0                   | 22.0                               | 19.0                                  | 18.0                                  | 16.0                                  |
|           | BGA     | 356       | 2.0                   | 12.0                               | 11.0                                  | 10.0                                  | 9.0                                   |
|           | FBGA    | 484       | 5.0                   | 23.0                               | 22.0                                  | 21.0                                  | 20.0                                  |
|           | BGA     | 652       | 1.0                   | 12.0                               | 11.0                                  | 10.0                                  | 9.0                                   |
|           | FBGA    | 672       | 5.0                   | 21.0                               | 20.0                                  | 19.0                                  | 18.0                                  |

**Table 37.** Thermal Resistance of APEX 20KE, 20KC, and 20K Devices (Part 2 of 3)

| Device                   | Package          | Pin Count | $\theta_{JC}$ ( $^{\circ}C/W$ ) | $\theta_{JA}$ ( $^{\circ}C/W$ )<br>Still Air | $\theta_{JA}$ ( $^{\circ}C/W$ )<br>100 ft./min. | $\theta_{JA}$ ( $^{\circ}C/W$ )<br>200 ft./min. | $\theta_{JA}$ ( $^{\circ}C/W$ )<br>400 ft./min. |
|--------------------------|------------------|-----------|---------------------------------|--|---|---|---|
| EP20K200C                | PQFP             | 208       | 4.0                             | 25.0   | 23.0  | 20.0  | 17.0  |
|                          | PQFP             | 240       | 3.0                             | 22.0   | 19.0  | 18.0  | 16.0  |
|                          | BGA              | 356       | 2.0                             | 12.0   | 11.0  | 10.0  | 9.0   |
|                          | FBGA             | 484       | 5.0                             | 23.0   | 22.0  | 21.0  | 20.0  |
| EP20K300E                | PQFP             | 240       | 3.0                             | 19.0   | 18.0  | 16.0  | 15.0  |
|                          | BGA              | 652       | 1.0                             | 12.0   | 11.0  | 10.0  | 9.0   |
|                          | FBGA             | 672       | 5.0                             | 20.0   | 19.0  | 18.0  | 17.0  |
| EP20K400                 | BGA              | 652       | 0.5                             | 9.0  | 8.0   | 7.0   | 6.0   |
|                          | PGA              | 655       | 1.0                             | 8.0  | 7.0   | 6.0   | 4.0   |
|                          | FBGA             | 672       | 0.4                             | 11.6   | 9.6   | 7.9   | 6.5   |
|                          | FBGA w/ fin (1)  | 672       | 0.5                             | 7.0  | 4.0   | 3.0   | 2.6   |
| EP20K400E<br>EP20K400C   | BGA              | 652       | 0.5                             | 9.0  | 8.0   | 7.0   | 6.0   |
|                          | FBGA (Cu lid)    | 672       | 0.3                             | 10.9   | 8.8   | 7.4   | 6.3   |
|                          | FBGA (AlSiC lid) |           | 0.4                             | 11.7   | 9.7   | 8.0   | 6.7   |
|                          | FBGA w/ fin (1)  | 672       | 0.5                             | 7.0  | 4.0   | 3.0   | 2.6   |
| EP20K600E<br>EP20K600C   | BGA              | 652       | 0.5                             | 9.0  | 8.0   | 7.0   | 6.0   |
|                          | FBGA (Cu lid)    | 672       | 0.2                             | 10.8   | 8.7   | 7.3   | 6.1   |
|                          | FBGA (AlSiC lid) |           | 0.3                             | 11.6   | 9.6   | 7.9   | 6.5   |
|                          | FBGA w/ fin (1)  | 672       | 0.5                             | 5.0  | 3.0   | 3.0   | 2.0   |
|                          | FBGA (Cu lid)    | 1,020     | 0.2                             | 9.9  | 7.8   | 6.5   | 5.4   |
|                          | FBGA (AlSiC lid) |           | 0.3                             | 10.4   | 8.4   | 6.8   | 5.6   |
|                          | FBGA w/ fin (1)  | 1,020     | 0.5                             | 5.0  | 3.0   | 3.0   | 2.0   |
| EP20K1000E<br>EP20K1000C | BGA (Cu lid)     | 652       | 0.1                             | 8.3  | 7.0   | 5.6   | 4.5   |
|                          | BGA (AlSiC lid)  |           | 0.2                             | 9.3  | 7.4   | 6.0   | 4.9   |
|                          | FBGA w/ fin (1)  | 652       | 0.5                             | 4.0  | 3.0   | 3.0   | 2.0   |
|                          | FBGA (Cu lid)    | 672       | 0.1                             | 10.6   | 8.6   | 7.2   | 6.0   |
|                          | FBGA (AlSiC lid) |           | 0.2                             | 11.4   | 9.4   | 7.7   | 6.3   |
|                          | FBGA w/ fin (1)  | 672       | 0.5                             | 6.0  | 4.0   | 3.0   | 2.0   |
|                          | FBGA (Cu lid)    | 1,020     | 0.1                             | 9.7  | 7.7   | 6.3   | 5.2   |
|                          | FBGA (AlSiC lid) |           | 0.2                             | 10.2   | 8.2   | 6.6   | 5.4   |
| FBGA w/ fin (1)          | 1,020            | 0.5       | 5.0                             | 3.0  | 2.0   | 2.0   |   |

**Table 37.** Thermal Resistance of APEX 20KE, 20KC, and 20K Devices (Part 3 of 3)

| Device     | Package          | Pin Count | $\theta_{JC}$ (° C/W) | $\theta_{JA}$ (° C/W)<br>Still Air | $\theta_{JA}$ (° C/W)<br>100 ft./min. | $\theta_{JA}$ (° C/W)<br>200 ft./min. | $\theta_{JA}$ (° C/W)<br>400 ft./min. |
|------------|------------------|-----------|-----------------------|------------------------------------|---------------------------------------|---------------------------------------|---------------------------------------|
| EP20K1500E | BGA (Cu lid)     | 652       | 0.1                   | 8.2                                | 6.9                                   | 5.5                                   | 4.4                                   |
|            | BGA (AlSiC lid)  |           | 0.2                   | 9.2                                | 7.3                                   | 5.8                                   | 4.8                                   |
|            | FBGA             | 652       | 0.1                   | 9.2                                | 7.3                                   | 5.8                                   | 4.8                                   |
|            | FBGA w/ fin (1)  | 652       | 0.5                   | 4.0                                | 3.0                                   | 2.5                                   | 2.0                                   |
|            | FBGA (Cu lid)    | 1,020     | 0.1                   | 9.6                                | 7.6                                   | 6.2                                   | 5.1                                   |
|            | FBGA (AlSiC lid) |           | 0.2                   | 10.1                               | 8.1                                   | 6.4                                   | 5.3                                   |
|            | FBGA w/ fin (1)  | 1,020     | 0.5                   | 5.0                                | 3.0                                   | 2.5                                   | 2.0                                   |

**Note to Table 37:**

- (1) “fin” is an extra heat sink that customers can add to the device. Several vendors make heat sinks, and they all have different sizes. Altera performed the thermal calculations in Table 37 using the following fin specifications: width: 0.25 mm; height: 7.0 mm; pitch: 1.5 mm; base thickness: 0.5 mm.

**ACEX 1K Devices Thermal Resistance**

Table 38 provides thermal resistance values for ACEX 1K devices.

**Table 38.** Thermal Resistance of ACEX 1K Devices

| Device  | Package | Pin Count | $\theta_{JC}$ (° C/W) | $\theta_{JA}$ (° C/W)<br>Still Air | $\theta_{JA}$ (° C/W)<br>100 ft./min. | $\theta_{JA}$ (° C/W)<br>200 ft./min. | $\theta_{JA}$ (° C/W)<br>400 ft./min. |
|---------|---------|-----------|-----------------------|------------------------------------|---------------------------------------|---------------------------------------|---------------------------------------|
| EP1K10  | TQFP    | 100       | 11.0                  | 37.0                               | 35.0                                  | 33.0                                  | 29.0                                  |
|         | TQFP    | 144       | 8.0                   | 31.0                               | 29.0                                  | 28.0                                  | 25.0                                  |
|         | PQFP    | 208       | 6.0                   | 30.0                               | 29.0                                  | 27.0                                  | 22.0                                  |
|         | FBGA    | 256       | 12.0                  | 37.0                               | 35.0                                  | 33.0                                  | 30.0                                  |
| EP1K30  | TQFP    | 144       | 8.0                   | 28.0                               | 27.0                                  | 26.0                                  | 24.0                                  |
|         | PQFP    | 208       | 5.0                   | 30.0                               | 28.0                                  | 26.0                                  | 21.0                                  |
|         | FBGA    | 256       | 9.0                   | 31.0                               | 29.0                                  | 28.0                                  | 25.0                                  |
| EP1K50  | TQFP    | 144       | 7.0                   | 26.0                               | 25.0                                  | 24.0                                  | 23.0                                  |
|         | PQFP    | 208       | 5.0                   | 29.0                               | 28.0                                  | 25.0                                  | 20.0                                  |
|         | FBGA    | 256       | 7.0                   | 30.0                               | 28.0                                  | 27.0                                  | 24.0                                  |
|         | FBGA    | 484       | 5.0                   | 25.0                               | 24.0                                  | 23.0                                  | 22.0                                  |
| EP1K100 | PQFP    | 208       | 5.0                   | 28.0                               | 26.0                                  | 23.0                                  | 18.0                                  |
|         | FBGA    | 256       | 6.0                   | 28.0                               | 26.0                                  | 25.0                                  | 23.0                                  |
|         | FBGA    | 484       | 5.0                   | 24.0                               | 23.0                                  | 22.0                                  | 21.0                                  |

## Mercury Devices Thermal Resistance

Table 39 provides thermal resistance values for Mercury devices.

**Table 39.** Thermal Resistance of Mercury Devices

| Device  | Package          | Pin Count | $\theta_{JC}$ (° C/W) | $\theta_{JA}$ (° C/W)<br>Still Air | $\theta_{JA}$ (° C/W)<br>100 ft./min. | $\theta_{JA}$ (° C/W)<br>200 ft./min. | $\theta_{JA}$ (° C/W)<br>400 ft./min. |
|---------|------------------|-----------|-----------------------|------------------------------------|---------------------------------------|---------------------------------------|---------------------------------------|
| EP1M120 | FBGA (Cu lid)    | 484       | 0.6                   | 12.2                               | 10.1                                  | 8.7                                   | 7.5                                   |
|         | FBGA (AlSiC lid) | 484       | 0.9                   | 13.0                               | 11.1                                  | 9.3                                   | 7.9                                   |
| EP1M350 | FBGA (Cu lid)    | 780       | 0.2                   | 10.5                               | 8.5                                   | 7.1                                   | 5.9                                   |
|         | FBGA (AlSiC lid) | 780       | 0.3                   | 11.0                               | 9.2                                   | 7.6                                   | 6.3                                   |

## FLEX Series Devices Thermal Resistance

Table 40 through Table 42 provide thermal resistance values for FLEX series devices.

### FLEX 10K Devices

Table 40 lists the thermal resistance of FLEX 10K devices.

**Table 40.** Thermal Resistance of FLEX 10K Devices (Part 1 of 3)

| Device    | Package | Pin Count | $\theta_{JC}$ (° C/W) | $\theta_{JA}$ (° C/W)<br>Still Air | $\theta_{JA}$ (° C/W)<br>100 ft./min. | $\theta_{JA}$ (° C/W)<br>200 ft./min. | $\theta_{JA}$ (° C/W)<br>400 ft./min. |
|-----------|---------|-----------|-----------------------|------------------------------------|---------------------------------------|---------------------------------------|---------------------------------------|
| EPF10K10  | PLCC    | 84        | 9.0                   | 28.0                               | 26.0                                  | 24.0                                  | 22.0                                  |
|           | TQFP    | 144       | 7.0                   | 26.0                               | 25.0                                  | 24.0                                  | 23.0                                  |
|           | PQFP    | 208       | 5.0                   | 29.0                               | 27.0                                  | 25.0                                  | 20.0                                  |
| EPF10K10A | TQFP    | 100       | 10.0                  | 35.0                               | 33.0                                  | 31.0                                  | 28.0                                  |
|           | TQFP    | 144       | 7.0                   | 29.0                               | 28.0                                  | 26.0                                  | 25.0                                  |
|           | PQFP    | 208       | 5.0                   | 30.0                               | 29.0                                  | 27.0                                  | 21.0                                  |
|           | FBGA    | 256       | 7.0                   | 33.0                               | 30.0                                  | 28.0                                  | 26.0                                  |
| EPF10K20  | TQFP    | 144       | 6.0                   | 24.0                               | 23.0                                  | 22.0                                  | 21.0                                  |
|           | RQFP    | 208       | 1.0                   | 17.0                               | 16.0                                  | 15.0                                  | 13.0                                  |
|           | RQFP    | 240       | 1.0                   | 14.0                               | 12.0                                  | 11.0                                  | 10.0                                  |
| EPF10K30  | RQFP    | 208       | 1.0                   | 17.0                               | 16.0                                  | 15.0                                  | 12.0                                  |
|           | RQFP    | 240       | 1.0                   | 13.0                               | 12.0                                  | 11.0                                  | 10.0                                  |
|           | BGA     | 356       | 1.0                   | 12.0                               | 11.0                                  | 10.0                                  | 9.0                                   |
| EPF10K30A | TQFP    | 144       | 7.0                   | 25.0                               | 24.0                                  | 23.0                                  | 22.0                                  |
|           | PQFP    | 208       | 5.0                   | 29.0                               | 27.0                                  | 24.0                                  | 19.0                                  |
|           | PQFP    | 240       | 4.0                   | 25.0                               | 22.0                                  | 20.0                                  | 17.0                                  |
|           | FBGA    | 256       | 6.0                   | 28.0                               | 26.0                                  | 24.0                                  | 23.0                                  |
|           | BGA     | 356       | 1.0                   | 12.0                               | 11.0                                  | 10.0                                  | 9.0                                   |
|           | FBGA    | 484       | 5.0                   | 24.0                               | 22.0                                  | 21.0                                  | 20.0                                  |
| EPF10K30E | TQFP    | 144       | 9.0                   | 28.0                               | 27.0                                  | 26.0                                  | 24.0                                  |
|           | PQFP    | 208       | 5.0                   | 30.0                               | 28.0                                  | 26.0                                  | 21.0                                  |
|           | FBGA    | 256       | 9.0                   | 31.0                               | 29.0                                  | 28.0                                  | 25.0                                  |
|           | FBGA    | 484       | 6.0                   | 26.0                               | 25.0                                  | 24.0                                  | 22.0                                  |

**Table 40.** Thermal Resistance of FLEX 10K Devices (Part 2 of 3)

| Device     | Package | Pin Count | $\theta_{JC}$ ( $^{\circ}$ C/W) | $\theta_{JA}$ ( $^{\circ}$ C/W)<br>Still Air | $\theta_{JA}$ ( $^{\circ}$ C/W)<br>100 ft./min. | $\theta_{JA}$ ( $^{\circ}$ C/W)<br>200 ft./min. | $\theta_{JA}$ ( $^{\circ}$ C/W)<br>400 ft./min. |
|------------|---------|-----------|---------------------------------|--|---|---|---|
| EPF10K40   | RQFP    | 208       | 1.0                             | 17.0   | 16.0  | 15.0  | 12.0  |
|            | RQFP    | 240       | 1.0                             | 13.0   | 12.0  | 11.0  | 10.0  |
| EPF10K50   | RQFP    | 240       | 1.0                             | 12.0   | 11.0  | 10.0  | 9.0   |
|            | BGA     | 356       | 1.0                             | 12.0   | 11.0  | 10.0  | 9.0   |
|            | PGA     | 403       | 3.0                             | 12.0   | 10.0  | 9.0   | 8.0   |
|            | PGA (1) |           | 3.0                             | 10.0   | 8.0   | 7.0   | 6.0   |
| EPF10K50V  | PQFP    | 240       | 4.0                             | 25.0   | 22.0  | 20.0  | 17.0  |
|            | RQFP    | 240       | 1.0                             | 13.0   | 12.0  | 11.0  | 10.0  |
|            | BGA     | 356       | 1.0                             | 12.0   | 11.0  | 10.0  | 9.0   |
|            | FBGA    | 484       | 5.0                             | 23.0   | 22.0  | 21.0  | 20.0  |
| EPF10K50E  | TQFP    | 144       | 9.0                             | 26.0   | 25.0  | 24.0  | 23.0  |
|            | PQFP    | 208       | 5.0                             | 29.0   | 27.0  | 24.0  | 19.0  |
|            | PQFP    | 240       | 4.0                             | 25.0   | 22.0  | 20.0  | 17.0  |
|            | FBGA    | 256       | 6.0                             | 29.0   | 27.0  | 26.0  | 24.0  |
|            | FBGA    | 484       | 5.0                             | 25.0   | 24.0  | 23.0  | 21.0  |
| EPF10K50S  | TQFP    | 144       | 9.0                             | 26.0   | 25.0  | 24.0  | 23.0  |
|            | PQFP    | 208       | 5.0                             | 29.0   | 28.0  | 25.0  | 20.0  |
|            | PQFP    | 240       | 4.0                             | 26.0   | 23.0  | 20.0  | 17.0  |
|            | FBGA    | 256       | 7.0                             | 30.0   | 28.0  | 27.0  | 24.0  |
|            | BGA     | 356       | 1.0                             | 12.0   | 11.0  | 10.0  | 9.0   |
|            | FBGA    | 484       | 5.0                             | 25.0   | 24.0  | 23.0  | 22.0  |
| EPF10K70   | RQFP    | 240       | 1.0                             | 12.0   | 11.0  | 10.0  | 9.0   |
|            | PGA     | 503       | 1.0                             | 8.0  | 7.0   | 6.0   | 4.0   |
| EPF10K100  | PGA     | 503       | 1.0                             | 8.0  | 7.0   | 6.0   | 4.0   |
|            | PGA (1) |           | 1.0                             | 6.0  | 5.0   | 4.0   | 3.0   |
|            | PGA (2) |           | —                               | 2.0  | —   | —   | —   |
| EPF10K100A | RQFP    | 240       | 1.0                             | 13.0   | 11.0  | 10.0  | 9.0   |
|            | BGA     | 356       | 1.0                             | 12.0   | 11.0  | 10.0  | 9.0   |
|            | FBGA    | 484       | 5.0                             | 22.0   | 21.0  | 20.0  | 18.0  |
|            | BGA     | 600       | 0.5                             | 10.0   | 9.0   | 8.0   | 7.0   |
| EPF10K100E | PQFP    | 208       | 5.0                             | 28.0   | 26.0  | 23.0  | 18.0  |
|            | PQFP    | 240       | 4.0                             | 23.0   | 21.0  | 19.0  | 16.0  |
|            | FBGA    | 256       | 6.0                             | 28.0   | 26.0  | 25.0  | 23.0  |
|            | BGA     | 356       | 1.0                             | 12.0   | 11.0  | 10.0  | 9.0   |
|            | FBGA    | 484       | 5.0                             | 24.0   | 23.0  | 22.0  | 21.0  |
| EPF10K130V | PGA     | 599       | 1.0                             | 8.0  | 7.0   | 6.0   | 4.0   |
|            | BGA     | 600       | 0.5                             | 10.0   | 9.0   | 8.0   | 7.0   |

**Table 40.** Thermal Resistance of FLEX 10K Devices (Part 3 of 3)

| Device     | Package | Pin Count | $\theta_{JC}$ ( $^{\circ}$ C/W) | $\theta_{JA}$ ( $^{\circ}$ C/W)<br>Still Air | $\theta_{JA}$ ( $^{\circ}$ C/W)<br>100 ft./min. | $\theta_{JA}$ ( $^{\circ}$ C/W)<br>200 ft./min. | $\theta_{JA}$ ( $^{\circ}$ C/W)<br>400 ft./min. |
|------------|---------|-----------|---------------------------------|--|---|---|---|
| EPF10K130E | PQFP    | 240       | 4.0                             | 21.0   | 19.0  | 17.0  | 15.0  |
|            | BGA     | 356       | 1.0                             | 12.0   | 11.0  | 10.0  | 9.0   |
|            | FBGA    | 484       | 5.0                             | 23.0   | 22.0  | 21.0  | 20.0  |
|            | BGA     | 600       | 0.5                             | 10.0   | 9.0   | 8.0   | 7.0   |
|            | FBGA    | 672       | 5.0                             | 21.0   | 20.0  | 19.0  | 18.0  |
| EPF10K200E | PGA     | 599       | 1.0                             | 8.0  | 7.0   | 6.0   | 4.0   |
|            | BGA     | 600       | 0.5                             | 10.0   | 9.0   | 8.0   | 7.0   |
|            | FBGA    | 672       | 5.0                             | 20.0   | 19.0  | 18.0  | 17.0  |
| EPF10K200S | RQFP    | 240       | 1.0                             | 13.0   | 11.0  | 10.0  | 9.0   |
|            | BGA     | 356       | 1.0                             | 12.0   | 11.0  | 10.0  | 9.0   |
|            | FBGA    | 484       | 5.0                             | 22.0   | 21.0  | 20.0  | 19.0  |
|            | BGA     | 600       | 0.5                             | 10.0   | 9.0   | 8.0   | 7.0   |
|            | FBGA    | 672       | 5.0                             | 21.0   | 20.0  | 19.0  | 18.0  |
| EPF10K250A | PGA     | 599       | 1.0                             | 8.0  | 7.0   | 6.0   | 4.0   |
|            | BGA     | 600       | 0.5                             | 10.0   | 9.0   | 8.0   | 7.0   |

**Notes to Table 40:**

- (1) With attached pin-fin heat sink.
- (2) With attached motor-driven fan heat sink.

**FLEX 8000 Devices**

Table 41 lists the thermal resistance of FLEX 8000 devices.

**Table 41.** Thermal Resistance of FLEX 8000 Devices (Part 1 of 2)

| Device   | Package | Pin Count | $\theta_{JC}$ ( $^{\circ}$ C/W) | $\theta_{JA}$ ( $^{\circ}$ C/W)<br>Still Air | $\theta_{JA}$ ( $^{\circ}$ C/W)<br>100 ft./min. | $\theta_{JA}$ ( $^{\circ}$ C/W)<br>200 ft./min. | $\theta_{JA}$ ( $^{\circ}$ C/W)<br>400 ft./min. |
|----------|---------|-----------|---------------------------------|--|---|---|---|
| EPF8282A | PLCC    | 84        | 10.0                            | 30.0   | 28.0  | 26.0  | 23.0  |
|          | TQFP    | 100       | 11.0                            | 36.0   | 34.0  | 32.0  | 29.0  |
| EPF8452A | PLCC    | 84        | 10.0                            | 30.0   | 28.0  | 26.0  | 23.0  |
|          | TQFP    | 100       | 11.0                            | 35.0   | 33.0  | 31.0  | 28.0  |
|          | PQFP    | 160       | 6.0                             | 32.0   | 31.0  | 30.0  | 28.0  |
| EPF8636A | PLCC    | 84        | 10.0                            | 29.0   | 28.0  | 26.0  | 23.0  |
|          | PQFP    | 160       | 6.0                             | 32.0   | 31.0  | 30.0  | 27.0  |
|          | PGA     | 192       | 6.0                             | 16.0   | 11.0  | 8.0   | 6.0   |
|          | PQFP    | 208       | 5.0                             | 30.0   | 38.0  | 26.0  | 20.0  |
|          | RQFP    | 208       | 1.0                             | 17.0   | 16.0  | 15.0  | 14.0  |

**Table 41.** Thermal Resistance of FLEX 8000 Devices (Part 2 of 2)

| Device    | Package | Pin Count | $\theta_{JC}$ (° C/W) | $\theta_{JA}$ (° C/W)<br>Still Air | $\theta_{JA}$ (° C/W)<br>100 ft./min. | $\theta_{JA}$ (° C/W)<br>200 ft./min. | $\theta_{JA}$ (° C/W)<br>400 ft./min. |
|-----------|---------|-----------|-----------------------|------------------------------------|---------------------------------------|---------------------------------------|---------------------------------------|
| EPF8820A  | TQFP    | 144       | 9.0                   | 26.0                               | 25.0                                  | 24.0                                  | 23.0                                  |
|           | PQFP    | 160       | 6.0                   | 32.0                               | 31.0                                  | 30.0                                  | 27.0                                  |
|           | PQFP    | 208       | 5.0                   | 29.0                               | 27.0                                  | 25.0                                  | 20.0                                  |
|           | RQFP    | 208       | 1.0                   | 17.0                               | 16.0                                  | 15.0                                  | 14.0                                  |
|           | BGA     | 225       | 6.0                   | 28.0                               | 19.0                                  | 14.0                                  | 11.0                                  |
| EPF81188A | PQFP    | 208       | 5.0                   | 28.0                               | 26.0                                  | 24.0                                  | 19.0                                  |
|           | PGA     | 232       | 2.0                   | 14.0                               | 10.0                                  | 7.0                                   | 5.0                                   |
|           | PQFP    | 240       | 4.0                   | 24.0                               | 21.0                                  | 19.0                                  | 16.0                                  |
|           | RQFP    | 240       | 1.0                   | 14.0                               | 12.0                                  | 11.0                                  | 10.0                                  |
| EPF81500A | PQFP    | 240       | 4.0                   | 22.0                               | 20.0                                  | 19.0                                  | 16.0                                  |
|           | RQFP    | 240       | 1.0                   | 13.0                               | 12.0                                  | 11.0                                  | 10.0                                  |
|           | PGA     | 280       | 2.0                   | 14.0                               | 10.0                                  | 7.0                                   | 5.0                                   |

**FLEX 6000 Devices**

Table 42 lists the thermal resistance of FLEX 6000 devices.

**Table 42.** Thermal Resistance of FLEX 6000 Devices

| Device   | Package | Pin Count | $\theta_{JC}$ (° C/W) | $\theta_{JA}$ (° C/W)<br>Still Air | $\theta_{JA}$ (° C/W)<br>100 ft./min. | $\theta_{JA}$ (° C/W)<br>200 ft./min. | $\theta_{JA}$ (° C/W)<br>400 ft./min. |
|----------|---------|-----------|-----------------------|------------------------------------|---------------------------------------|---------------------------------------|---------------------------------------|
| EPF6010A | TQFP    | 100       | 11.0                  | 35.0                               | 33.0                                  | 31.0                                  | 28.0                                  |
|          | TQFP    | 144       | 10.0                  | 28.0                               | 26.0                                  | 25.0                                  | 24.0                                  |
| EPF6016  | TQFP    | 144       | 10.0                  | 28.0                               | 26.0                                  | 25.0                                  | 24.0                                  |
|          | PQFP    | 208       | 5.0                   | 30.0                               | 28.0                                  | 26.0                                  | 21.0                                  |
|          | PQFP    | 240       | 4.0                   | 26.0                               | 24.0                                  | 21.0                                  | 17.0                                  |
|          | BGA     | 256       | 6.0                   | 28.0                               | 22.0                                  | 20.0                                  | 19.0                                  |
| EPF6016A | TQFP    | 100       | 11.0                  | 35.0                               | 33.0                                  | 31.0                                  | 28.0                                  |
|          | FBGA    |           | 14.0                  | 36.0                               | 34.0                                  | 32.0                                  | 29.0                                  |
|          | TQFP    | 144       | 10.0                  | 29.0                               | 28.0                                  | 26.0                                  | 24.0                                  |
|          | PQFP    | 208       | 5.0                   | 30.0                               | 29.0                                  | 26.0                                  | 21.0                                  |
|          | FBGA    | 256       | 10.0                  | 32.0                               | 30.0                                  | 29.0                                  | 26.0                                  |
| EPF6024A | TQFP    | 144       | 10.0                  | 27.0                               | 26.0                                  | 25.0                                  | 24.0                                  |
|          | PQFP    | 208       | 5.0                   | 29.0                               | 28.0                                  | 26.0                                  | 20.0                                  |
|          | PQFP    | 240       | 4.0                   | 26.0                               | 23.0                                  | 21.0                                  | 17.0                                  |
|          | BGA     | 256       | 6.0                   | 28.0                               | 22.0                                  | 20.0                                  | 19.0                                  |
|          | FBGA    |           | 8.0                   | 30.0                               | 29.0                                  | 27.0                                  | 25.0                                  |

**Excalibur Devices Thermal Resistance**

Table 43 provides thermal resistance values for Excalibur devices.

**Table 43.** Thermal Resistance of Excalibur Embedded Processor Solutions

| <b>Device</b> | <b>Package</b>              | <b>Pin Count</b> | $\theta_{JC}$ ( $^{\circ}$ C/W) | $\theta_{JA}$ ( $^{\circ}$ C/W)<br>Still Air | $\theta_{JA}$ ( $^{\circ}$ C/W)<br>100 ft./min. | $\theta_{JA}$ ( $^{\circ}$ C/W)<br>200 ft./min. | $\theta_{JA}$ ( $^{\circ}$ C/W)<br>400 ft./min. |
|---------------|-----------------------------|------------------|---------------------------------|--|---|---|---|
| EPXA1         | FBGA                        | 484              | 4.0                             | 20.0   | 18.3  | 15.8  | 13.9  |
|               | FBGA, Flip Chip (Cu lid)    | 672              | 0.5                             | 11.3   | 9.3   | 7.9   | 6.7   |
|               | FBGA, Flip Chip (AlSiC lid) | 672              | 0.8                             | 12.2   | 10.2  | 8.6   | 7.2   |
| EPXA4         | FBGA, Flip Chip (Cu lid)    | 672              | 0.2                             | 10.8   | 8.8   | 7.3   | 6.2   |
|               | FBGA, Flip Chip (AlSiC lid) | 672              | 0.3                             | 11.6   | 9.6   | 7.9   | 6.6   |
|               | FBGA, Flip Chip (Cu lid)    | 1,020            | 0.2                             | 9.9  | 7.9   | 6.5   | 5.4   |
|               | FBGA, Flip Chip (AlSiC lid) | 1,020            | 0.3                             | 10.4   | 8.5   | 6.9   | 5.7   |
| EPXA10        | FBGA, Flip Chip (Cu lid)    | 1,020            | 0.1                             | 9.6  | 7.6   | 6.2   | 5.1   |
|               | FBGA, Flip Chip (AlSiC lid) | 1,020            | 0.2                             | 10.0   | 8.0   | 6.4   | 5.7   |

## Package Outlines

The package outlines on the following pages are listed in order of ascending pin count. Altera package outlines meet the requirements of *JEDEC Publication No. 95*.



All lidless flip chip and wire bond packages are non-vented packages. All other flip chip packages are vented packages.

## 8-Pin Plastic Dual In-Line Package (PDIP)—Wire Bond

- All dimensions and tolerances conform to ASME Y14.5M - 1994.
- Controlling dimension is in inches.
- Pin 1 may be indicated by an ID dot, or a special feature, in its proximity on package surface.

| Package Information        |  |
|----------------------------|--|
| Description                | Specification                                  |
| Ordering Code Reference    | P  |
| Package Acronym            | PDIP   |
| Leadframe Material         | Copper   |
| Lead Finish (Plating)      | Regular: 85Sn:15Pb (Typ.)<br>Pb-free: Matte Sn |
| JEDEC Outline Reference    | MS-001 Variation: BA                           |
| Lead Coplanarity           | NA   |
| Weight                     | 0.6 g (Typ.)                                   |
| Moisture Sensitivity Level | Printed on moisture barrier bag                |

| Package Outline Dimension Table |           |       |       |
|---------------------------------|-----------|-------|-------|
| Symbol                          | Inches    |       |       |
|                                 | Min.      | Nom.  | Max.  |
| A                               | —         | —     | 0.170 |
| A1                              | 0.015     | —     | —     |
| A2                              | 0.130 TYP |       |       |
| D                               | 0.360     | —     | 0.380 |
| E                               | 0.300     | 0.310 | 0.325 |
| E1                              | 0.240     | 0.250 | 0.260 |
| L                               | 0.125     | —     | 0.135 |
| b                               | 0.016     | 0.018 | 0.020 |
| c                               | 0.008     | 0.010 | 0.014 |
| e                               | 0.100 BSC |       |       |

## Package Outline



## 20-Pin Plastic J-Lead Chip Carrier (PLCC)—Wire Bond

- All dimensions and tolerances conform to ASME Y14.5M – 1994.
- Controlling dimension is in inches.
- Pin 1 is generally indicated by an indentation in the plastic body, in Pin 1's proximity, on package surface.

| Package Information        |  |
|----------------------------|--|
| Description                | Specification                                  |
| Ordering Code Reference    | L  |
| Package Acronym            | PLCC   |
| Leadframe Material         | Copper   |
| Lead Finish (Plating)      | Regular: 85Sn:15Pb (Typ.)<br>Pb-free: Matte Sn |
| JEDEC Outline Reference    | MS-018 Variation: AA                           |
| Lead Coplanarity           | 0.004 inches (0.10mm)                          |
| Weight                     | 0.8 g (Typ.)                                   |
| Moisture Sensitivity Level | Printed on moisture barrier bag                |

| Package Outline Dimension Table |           |       |       |
|---------------------------------|-----------|-------|-------|
| Symbol                          | Inches    |       |       |
|                                 | Min.      | Nom.  | Max.  |
| A                               | 0.165     | 0.172 | 0.180 |
| A1                              | 0.020     | —     | —     |
| A2                              | 0.150 TYP |       |       |
| D                               | 0.385     | 0.390 | 0.395 |
| D1                              | 0.350     | 0.353 | 0.356 |
| D2                              | 0.290     | 0.310 | 0.330 |
| E                               | 0.385     | 0.390 | 0.395 |
| E1                              | 0.350     | 0.353 | 0.356 |
| E2                              | 0.290     | 0.310 | 0.330 |
| b                               | 0.013     | —     | 0.021 |
| c                               | 0.010 TYP |       |       |
| e                               | 0.050 TYP |       |       |

## Package Outline



## 32-Pin Plastic Thin Quad Flat Pack (TQFP)—Wire Bond

- All dimensions and tolerances conform to ASME Y14.5M – 1994.
- Controlling dimension is in millimeters.
- Pin 1 may be indicated by an ID dot, or a special feature, in its proximity on package surface.

| Package Information        |  |
|----------------------------|--|
| Description                | Specification                                  |
| Ordering Code Reference    | T  |
| Package Acronym            | TQFP   |
| Leadframe Material         | Copper   |
| Lead Finish (Plating)      | Regular: 85Sn:15Pb (Typ.)<br>Pb-free: Matte Sn |
| JEDEC Outline Reference    | MS-026 Variation: ABA                          |
| Lead Coplanarity           | 0.004 inches (0.1mm)                           |
| Weight                     | 0.2 g (Typ.)                                   |
| Moisture Sensitivity Level | Printed on moisture barrier bag                |

| Package Outline Dimension Table |             |      |      |
|---------------------------------|-------------|------|------|
| Symbol                          | Millimeters |      |      |
|                                 | Min.        | Nom. | Max. |
| A                               | —           | —    | 1.20 |
| A1                              | 0.05        | —    | 0.15 |
| A2                              | 0.95        | 1.00 | 1.05 |
| D                               | 9.00 BSC    |      |      |
| D1                              | 7.00 BSC    |      |      |
| E                               | 9.00 BSC    |      |      |
| E1                              | 7.00 BSC    |      |      |
| L                               | 0.45        | 0.60 | 0.75 |
| L1                              | 1.00 REF    |      |      |
| S                               | 0.20        | —    | —    |
| b                               | 0.30        | 0.37 | 0.45 |
| c                               | 0.09        | —    | 0.20 |
| e                               | 0.80 BSC    |      |      |
| θ                               | 0°          | 3.5° | 7°   |

**Package Outline**

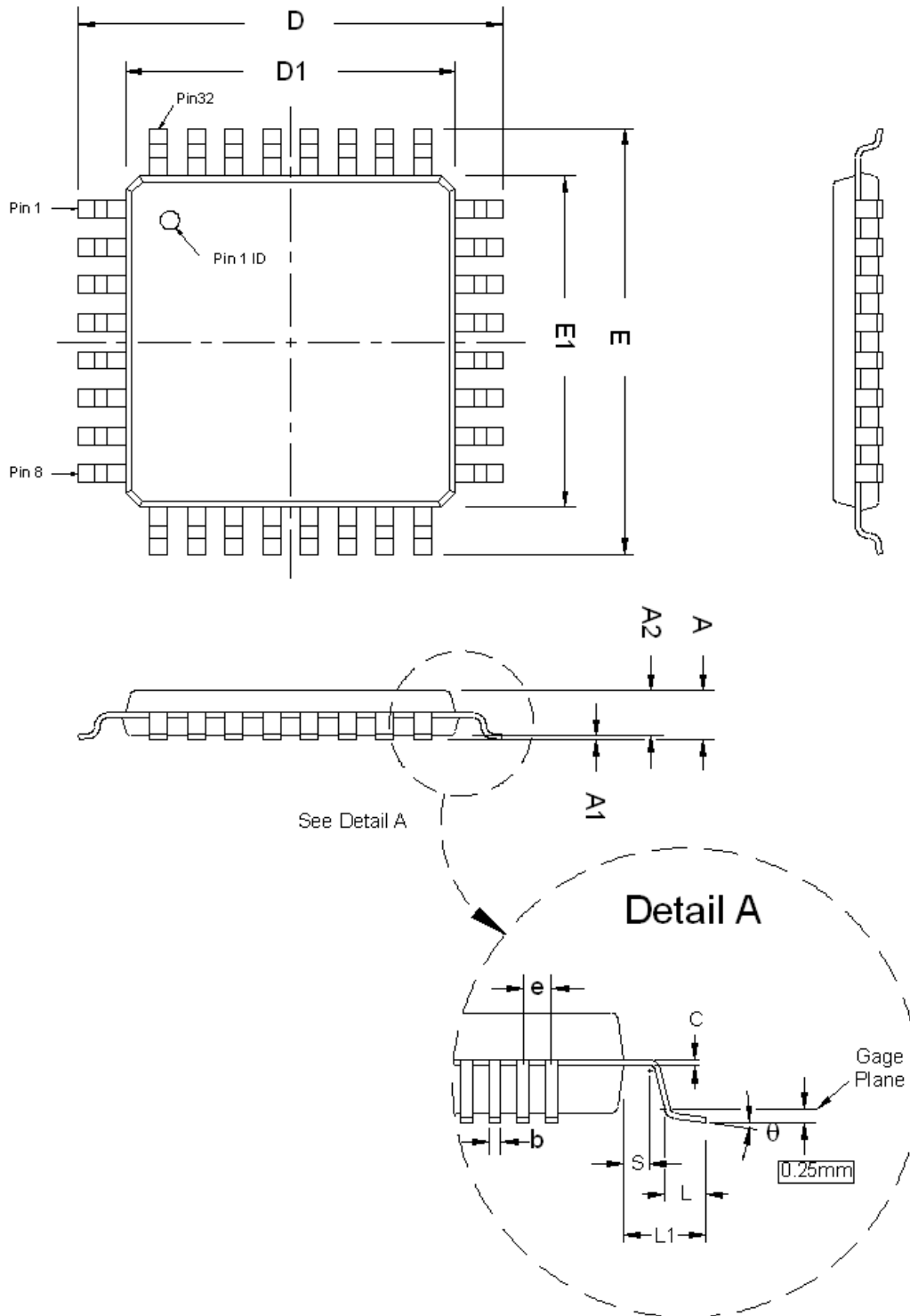

## 44-Pin Plastic J-Lead Chip Carrier (PLCC)—Wire Bond

- All dimensions and tolerances conform to ASME Y14.5M - 1994.
- Controlling dimension is in inches.
- Pin 1 is generally indicated by an indentation in the plastic body, in Pin 1's proximity, on package surface.

| Package Information        |  |
|----------------------------|--|
| Description                | Specification                                  |
| Ordering Code Reference    | L  |
| Package Acronym            | PLCC   |
| Leadframe Material         | Copper   |
| Lead Finish (Plating)      | Regular: 85Sn:15Pb (Typ.)<br>Pb-free: Matte Sn |
| JEDEC Outline Reference    | MS-018 Variation: AC                           |
| Lead Coplanarity           | 0.004 inches (0.10 mm)                         |
| Weight                     | 2.6 g (Typ.)                                   |
| Moisture Sensitivity Level | Printed on moisture barrier bag                |

| Package Outline Dimension Table |           |       |       |
|---------------------------------|-----------|-------|-------|
| Symbol                          | Inches    |       |       |
|                                 | Min.      | Nom.  | Max.  |
| A                               | 0.165     | 0.172 | 0.180 |
| A1                              | 0.020     | —     | —     |
| A2                              | 0.150 TYP |       |       |
| D                               | 0.685     | 0.690 | 0.695 |
| D1                              | 0.650     | 0.653 | 0.656 |
| D2                              | 0.582     | 0.610 | 0.638 |
| E                               | 0.685     | 0.690 | 0.695 |
| E1                              | 0.650     | 0.653 | 0.656 |
| E2                              | 0.582     | 0.610 | 0.638 |
| b                               | 0.013     | —     | 0.021 |
| c                               | 0.010 TYP |       |       |
| e                               | 0.050 TYP |       |       |

## Package Outline



## 44-Pin Plastic Thin Quad Flat Pack (TQFP)—Wire Bond

- All dimensions and tolerances conform to ASME Y14.5M – 1994.
- Controlling dimension is in millimeters.
- Pin 1 may be indicated by an ID dot, or a special feature, in its proximity on package surface.

| Package Information        |  |
|----------------------------|--|
| Description                | Specification                                  |
| Ordering Code Reference    | T  |
| Package Acronym            | TQFP   |
| Leadframe Material         | Copper   |
| Lead Finish (Plating)      | Regular: 85Sn:15Pb (Typ.)<br>Pb-free: Matte Sn |
| JEDEC Outline Reference    | MS-026 Variation: ACB                          |
| Lead Coplanarity           | 0.004 inches (0.1mm)                           |
| Weight                     | 0.3 g (Typ.)                                   |
| Moisture Sensitivity Level | Printed on moisture barrier bag                |

| Package Outline Dimension Table |             |      |      |
|---------------------------------|-------------|------|------|
| Symbol                          | Millimeters |      |      |
|                                 | Min.        | Nom. | Max. |
| A                               | —           | —    | 1.20 |
| A1                              | 0.05        | —    | 0.15 |
| A2                              | 0.95        | —    | —    |
| D                               | 12.00 BSC   |      |      |
| D1                              | 10.00 BSC   |      |      |
| E                               | 12.00 BSC   |      |      |
| E1                              | 10.00 BSC   |      |      |
| L                               | 0.45        | 0.60 | 0.75 |
| L1                              | 1.00 REF    |      |      |
| S                               | 0.20        | —    | —    |
| b                               | 0.30        | 0.37 | 0.45 |
| c                               | 0.09        | —    | 0.20 |
| e                               | 0.80 BSC    |      |      |
| θ                               | 0°          | 3.5° | 7°   |

**Package Outline**

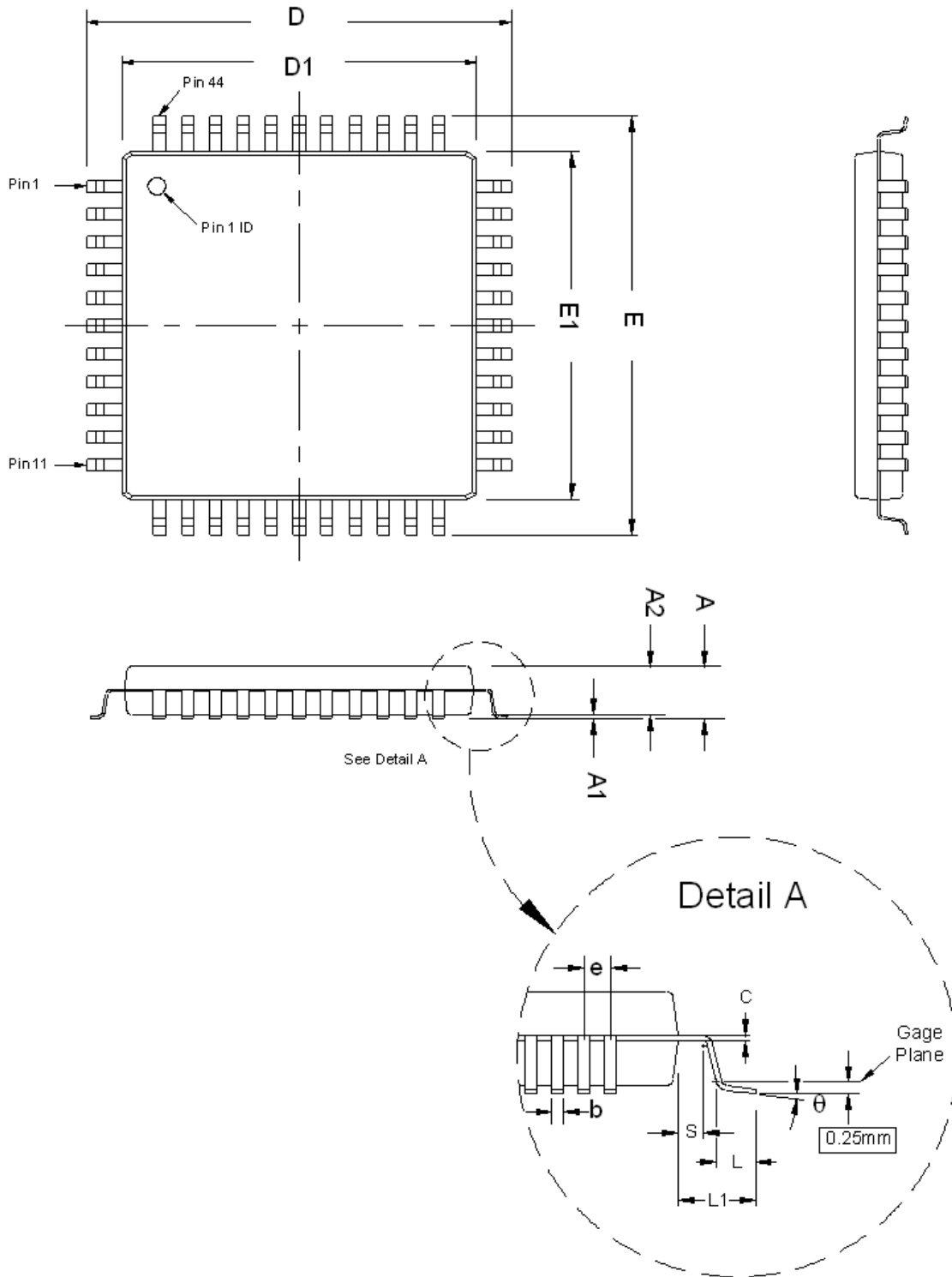

## 49-Pin Ultra FineLine Ball-Grid Array (UBGA)—Wire Bond

- All dimensions and tolerances conform to ASME Y14.5M – 1994.
- Controlling dimension is in millimeters.
- Pin A1 may be indicated by an ID dot, or a special feature, in its proximity on package surface.

| Package Information        |   |
|----------------------------|---|
| Description                | Specification   |
| Ordering Code Reference    | U   |
| Package Acronym            | UBGA  |
| Substrate Material         | BT  |
| Solder Ball Composition    | Regular: 63Sn:37Pb (Typ.)<br>Pb-free: Sn:3Ag:0.5Cu (Typ.) |
| JEDEC Outline Reference    | MO-216 Variation: BAB-2                                   |
| Lead Coplanarity           | 0.005 inches (0.12mm)                                     |
| Weight                     | 0.2 g (Typ.)  |
| Moisture Sensitivity Level | Printed on moisture barrier bag                           |

| Package Outline Dimension Table |             |      |      |
|---------------------------------|-------------|------|------|
| Symbol                          | Millimeters |      |      |
|                                 | Min.        | Nom. | Max. |
| A                               | —           | —    | 1.55 |
| A1                              | 0.20        | —    | —    |
| A2                              | —           | —    | 1.35 |
| A3                              | 0.70 TYP    |      |      |
| D                               | 7.00 BSC    |      |      |
| E                               | 7.00 BSC    |      |      |
| b                               | 0.40        | 0.50 | 0.60 |
| e                               | 0.80 BSC    |      |      |

**Package Outline**



## 64-Pin Plastic Enhanced Quad Flat Pack (EQFP)—Wire Bond

- All dimensions and tolerances conform to ASME Y14.5M – 1994.
- Controlling dimension is in millimeters.
- Pin A1 may be indicated by an ID dot, or a special feature, in its proximity on package surface.

| Package Information        |  |
|----------------------------|--|
| Description                | Specification                                  |
| Ordering Code Reference    | E  |
| Package Acronym            | EQFP   |
| Leadframe Material         | Copper   |
| Lead Finish (plating)      | Regular: 85Sn:15Pb (Typ.)<br>Pb-free: Matte Sn |
| JEDEC Outline Reference    | MS-026 Variation: ABD-HD                       |
| Lead Coplanarity           | 0.003 inch (0.08 mm)                           |
| Weight                     | 0.15 g (Typ.)                                  |
| Moisture Sensitivity Level | Printed on moisture barrier bag                |

| Package Outline Dimension Table |             |      |      |
|---------------------------------|-------------|------|------|
| Symbol                          | Millimeters |      |      |
|                                 | Min.        | Nom. | Max. |
| A                               | —           | —    | 1.20 |
| A1                              | 0.05        | —    | 0.15 |
| A2                              | 0.95        | 1.00 | 1.05 |
| D                               | 9.00 BSC    |      |      |
| D1                              | 7.00 BSC    |      |      |
| D2                              | 3.50        | 4.50 | 5.50 |
| E                               | 9.00 BSC    |      |      |
| E1                              | 7.00 BSC    |      |      |
| E2                              | 3.50        | 4.50 | 5.50 |
| L                               | 0.45        | 0.60 | 0.75 |
| L1                              | 1.00 REF    |      |      |
| S                               | 0.20        | —    | —    |
| b                               | 0.13        | 0.18 | 0.23 |
| c                               | 0.09        | —    | 0.20 |
| e                               | 0.40 BSC    |      |      |
| θ                               | 0°          | 3.5° | 7°   |

**Package Outline**

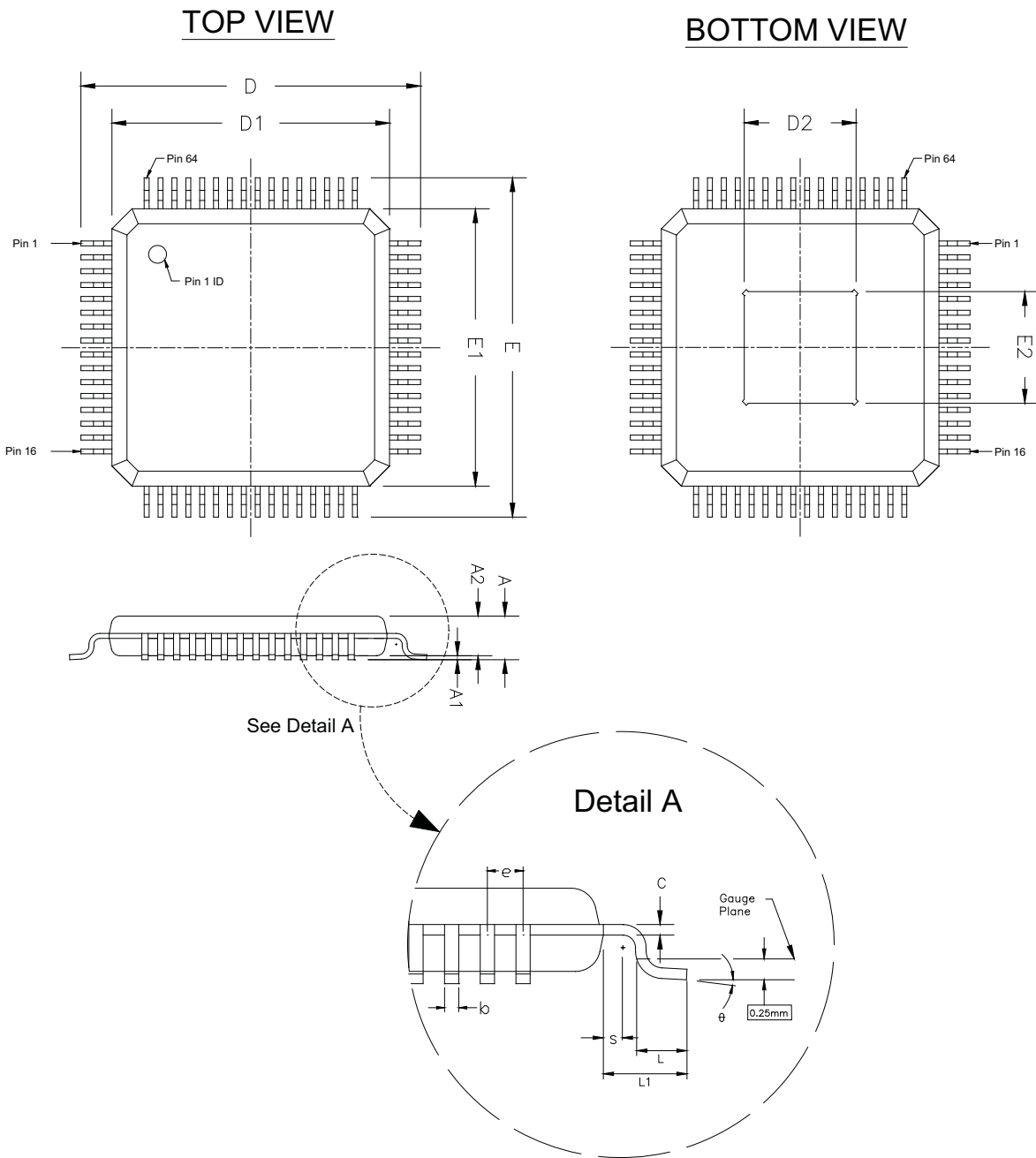

## 84-Pin Plastic J-Lead Chip Carrier (PLCC)—Wire Bond

- All dimensions and tolerances conform to ASME Y14.5M – 1994.
- Controlling dimension is in inches.
- Pin 1 is generally indicated by an indentation in the plastic body, in Pin 1's proximity, on package surface.

| Package Information        |  |
|----------------------------|--|
| Description                | Specification                                  |
| Ordering Code Reference    | L  |
| Package Acronym            | PLCC   |
| Leadframe Material         | Copper   |
| Lead Finish (Plating)      | Regular: 85Sn:15Pb (Typ.)<br>Pb-free: Matte Sn |
| JEDEC Outline Reference    | MS-018 Variation: AF                           |
| Lead Coplanarity           | 0.004 inches (0.10mm)                          |
| Weight                     | 7.9 g (Typ.)                                   |
| Moisture Sensitivity Level | Printed on moisture barrier bag                |

| Package Outline Dimension Table |           |       |       |
|---------------------------------|-----------|-------|-------|
| Symbol                          | Inches    |       |       |
|                                 | Min.      | Nom.  | Max.  |
| A                               | 0.165     | 0.172 | 0.180 |
| A1                              | 0.020     | —     | —     |
| A2                              | 0.150 TYP |       |       |
| D                               | 1.185     | 1.190 | 1.195 |
| D1                              | 1.150     | 1.154 | 1.158 |
| D2                              | 1.082     | 1.110 | 1.138 |
| E                               | 1.185     | 1.190 | 1.195 |
| E1                              | 1.150     | 1.154 | 1.158 |
| E2                              | 1.082     | 1.110 | 1.138 |
| b                               | 0.013     | —     | 0.021 |
| c                               | 0.008 TYP |       |       |
| e                               | 0.050 TYP |       |       |

## Package Outline



## 88-Pin Ultra FineLine Ball-Grid Array (UBGA)—Wire Bond

- All dimensions and tolerances conform to ASME Y14.5M - 1994.
- Controlling dimension is in millimeters.
- Pin A1 may be indicated by an ID dot, or a special feature, in its proximity on package surface.

| Package Information        |   |
|----------------------------|---|
| Description                | Specification   |
| Ordering Code Reference    | U   |
| Package Acronym            | UBGA  |
| Substrate Material         | BT  |
| Solder Ball Composition    | Regular: 63Sn:37Pb (Typ.)<br>Pb-free: Sn:3Ag:0.5Cu (Typ.) |
| JEDEC Outline              | MO-219  |
| Lead Coplanarity           | 0.005 inches (0.12 mm)                                    |
| Weight                     | 0.4 g (Typ.)  |
| Moisture Sensitivity Level | Printed on moisture barrier bag                           |

| Package Outline Dimension Table |             |      |      |
|---------------------------------|-------------|------|------|
| Symbol                          | Millimeters |      |      |
|                                 | Min.        | Nom. | Max. |
| A                               | —           | —    | 1.40 |
| A1                              | 0.25        | —    | —    |
| A2                              | 0.80        | —    | —    |
| A3                              | 0.70 REF    |      |      |
| D                               | 11.00 BSC   |      |      |
| E                               | 8.00 BSC    |      |      |
| b                               | 0.40        | 0.45 | 0.50 |
| e                               | 0.80 BSC    |      |      |

**Package Outline**



## 100-Pin FineLine Ball-Grid Array (FBGA), Option 1—Wire Bond

- All dimensions and tolerances conform to ASME Y14.5M – 1994.
- Controlling dimension is in millimeters.
- Pin A1 may be indicated by an ID dot, or a special feature, in its proximity on the package surface.



This POD is applicable to F100 packages of all products except MAX II, which is assembled in Option 2 package outlines.

| Package Information        |   |
|----------------------------|---|
| Description                | Specification   |
| Ordering Code Reference    | F   |
| Package Acronym            | FBGA  |
| Substrate Material         | BT  |
| Solder ball composition    | Regular: 63Sn:37Pb (Typ.)<br>Pb-free: Sn:3Ag:0.5Cu (Typ.) |
| JEDEC Outline Reference    | MO-192 Variation: AAC-1                                   |
| Lead Coplanarity           | 0.008 inches (0.20mm)                                     |
| Weight                     | 0.6 g (Typ.)  |
| Moisture Sensitivity Level | Printed on moisture barrier bag                           |

| Package Outline Dimension Table |             |      |      |
|---------------------------------|-------------|------|------|
| Symbol                          | Millimeters |      |      |
|                                 | Min.        | Nom. | Max. |
| A                               | —           | —    | 1.70 |
| A1                              | 0.30        | —    | —    |
| A2                              | 0.25        | —    | 1.10 |
| A3                              | —           | —    | 0.80 |
| D                               | 11.00 BSC   |      |      |
| E                               | 11.00 BSC   |      |      |
| b                               | 0.50        | 0.60 | 0.70 |
| e                               | 1.00 BSC    |      |      |

## Package Outline



## 100-Pin Plastic Quad Flat Pack (PQFP)—Wire Bond

- All dimensions and tolerances conform to ASME Y14.5M – 1994.
- Controlling dimension is in millimeters.
- Pin 1 may be indicated by an ID dot, or a special feature, in its proximity on the package surface.

| Package Information        |  |
|----------------------------|--|
| Description                | Specification                                  |
| Ordering Code Reference    | Q  |
| Package Acronym            | PQFP   |
| Leadframe Material         | Copper   |
| Lead Finish (Plating)      | Regular: 85Sn:15Pb (Typ.)<br>Pb-free: Matte Sn |
| JEDEC Outline Reference    | MS-022 Variation: GC-1                         |
| Lead Coplanarity           | 0.004 inches (0.10mm)                          |
| Weight                     | 1.9 g (Typ.)                                   |
| Moisture Sensitivity Level | Printed on moisture barrier bag                |

| Package Outline Dimension Table |             |      |      |
|---------------------------------|-------------|------|------|
| Symbol                          | Millimeters |      |      |
|                                 | Min.        | Nom. | Max. |
| A                               | —           | —    | 3.40 |
| A1                              | 0.25        | —    | 0.50 |
| A2                              | 2.50        | 2.70 | 2.90 |
| D                               | 17.20 BSC   |      |      |
| D1                              | 14.00 BSC   |      |      |
| E                               | 23.20 BSC   |      |      |
| E1                              | 20.00 BSC   |      |      |
| L                               | 0.73        | 0.88 | 1.03 |
| L1                              | 1.60 REF    |      |      |
| S                               | 0.20        | —    | —    |
| b                               | 0.22        | —    | 0.40 |
| c                               | 0.11        | —    | 0.23 |
| e                               | 0.65 BSC    |      |      |
| θ                               | 0°          | —    | 7°   |

## Package Outline



## 100-Pin Plastic Thin Quad Flat Pack (TQFP)—Wire Bond

- All dimensions and tolerances conform to ASME Y14.5M – 1994.
- Controlling dimension is in millimeters.
- Pin 1 may be indicated by an ID dot, or a special feature, in its proximity on package surface.

| Package Information        |  |
|----------------------------|--|
| Description                | Specification                                  |
| Ordering Code Reference    | T  |
| Package Acronym            | TQFP   |
| Leadframe Material         | Copper   |
| Lead Finish (Plating)      | Regular: 85Sn:15Pb (Typ.)<br>Pb-free: Matte Sn |
| JEDEC Outline Reference    | MS-026 Variation: AED                          |
| Lead Coplanarity           | 0.003 inches (0.08mm)                          |
| Weight                     | 0.6 g (Typ.)                                   |
| Moisture Sensitivity Level | Printed on moisture barrier bag                |

| Package Outline Dimension Table |             |      |      |
|---------------------------------|-------------|------|------|
| Symbol                          | Millimeters |      |      |
|                                 | Min.        | Nom. | Max. |
| A                               | —           | —    | 1.20 |
| A1                              | 0.05        | —    | 0.15 |
| A2                              | 0.95        | 1.00 | 1.05 |
| D                               | 16.00 BSC   |      |      |
| D1                              | 14.00 BSC   |      |      |
| E                               | 16.00 BSC   |      |      |
| E1                              | 14.00 BSC   |      |      |
| L                               | 0.45        | 0.60 | 0.75 |
| L1                              | 1.00 REF    |      |      |
| S                               | 0.20        | —    | —    |
| b                               | 0.17        | 0.22 | 0.27 |
| c                               | 0.09        | —    | 0.20 |
| e                               | 0.50 BSC    |      |      |
| θ                               | 0°          | 3.5° | 7°   |

**Package Outline**



## 144-Pin Plastic Enhanced Quad Flat Pack (EQFP)—Wire Bond

- All dimensions and tolerances conform to ASME Y14.5M – 1994.
- Controlling dimension is in millimeters.
- Pin 1 may be indicated by an ID dot, or a special feature, in its proximity on package surface.

| Package Information        |  |
|----------------------------|--|
| Description                | Specification                                  |
| Ordering Code Reference    | E  |
| Package Acronym            | EQFP   |
| Leadframe Material         | Copper   |
| Lead Finish (Plating)      | Regular: 85Sn:15Pb (Typ.)<br>Pb-free: Matte Sn |
| JEDEC Outline Reference    | MS-026 Variation: BFB                          |
| Lead Coplanarity           | 0.003 inches (0.08mm)                          |
| Weight                     | 1.1 g (Typ.)                                   |
| Moisture Sensitivity Level | Printed on moisture barrier bag                |

| Package Outline Dimension Table |             |      |      |
|---------------------------------|-------------|------|------|
| Symbol                          | Millimeters |      |      |
|                                 | Min.        | Nom. | Max. |
| A                               | —           | —    | 1.60 |
| A1                              | 0.05        | —    | 0.15 |
| A2                              | 1.35        | 1.40 | 1.45 |
| D                               | 22.00 BSC   |      |      |
| D1                              | 20.00 BSC   |      |      |
| D2                              | 4.00        | —    | —    |
| E                               | 22.00 BSC   |      |      |
| E1                              | 20.00 BSC   |      |      |
| E2                              | 4.00        | —    | —    |
| L                               | 0.45        | 0.60 | 0.75 |
| L1                              | 1.00 REF    |      |      |
| S                               | 0.20        | —    | —    |
| b                               | 0.17        | 0.22 | 0.27 |
| c                               | 0.09        | —    | 0.20 |
| e                               | 0.50 BSC    |      |      |
| θ                               | 0°          | 3.5° | 7°   |

**Package Outline**



## 144-Pin FineLine Ball-Grid Array (FBGA)—Wire Bond

- All dimensions and tolerances conform to ASME Y14.5M – 1994.
- Controlling dimension is in millimeters.
- Pin A1 may be indicated by an ID dot, or a special feature, in its proximity on package surface.

| Package Information        |   |
|----------------------------|---|
| Description                | Specification   |
| Ordering Code Reference    | F   |
| Package Acronym            | FBGA  |
| Substrate Material         | BT  |
| Solder Ball Composition    | Regular: 63Sn:37Pb (Typ.)<br>Pb-free: Sn:3Ag:0.5Cu (Typ.) |
| JEDEC Outline Reference    | MO-192 Variation: AAD-1                                   |
| Lead Coplanarity           | 0.008 inches (0.20mm)                                     |
| Weight                     | 0.8 g (Typ.)  |
| Moisture Sensitivity Level | Printed on moisture barrier bag                           |

| Package Outline Dimension Table |             |      |      |
|---------------------------------|-------------|------|------|
| Symbol                          | Millimeters |      |      |
|                                 | Min.        | Nom. | Max. |
| A                               | —           | —    | 2.20 |
| A1                              | 0.30        | —    | —    |
| A2                              | 0.25        | —    | 1.80 |
| A3                              | 0.70 REF    |      |      |
| D                               | 13.00 BSC   |      |      |
| E                               | 13.00 BSC   |      |      |
| b                               | 0.50        | 0.60 | 0.70 |
| e                               | 1.00 BSC    |      |      |

## Package Outline



## 144-Pin Plastic Thin Quad Flat Pack (TQFP)—Wire Bond

- All dimensions and tolerances conform to ASME Y14.5M – 1994.
- Controlling dimension is in millimeters.
- Pin 1 may be indicated by an ID dot, or a special feature, in its proximity on package surface.

| Package Information        |  |
|----------------------------|--|
| Description                | Specification                                  |
| Ordering Code Reference    | T  |
| Package Acronym            | TQFP   |
| Leadframe Material         | Copper   |
| Lead Finish (Plating)      | Regular: 85Sn:15Pb (Typ.)<br>Pb-free: Matte Sn |
| JEDEC Outline Reference    | MS-026 Variation: BFB                          |
| Lead Coplanarity           | 0.003 inches (0.08mm)                          |
| Weight                     | 1.1 g (Typ.)                                   |
| Moisture Sensitivity Level | Printed on moisture barrier bag                |

| Package Outline Dimension Table |             |      |      |
|---------------------------------|-------------|------|------|
| Symbol                          | Millimeters |      |      |
|                                 | Min.        | Nom. | Max. |
| A                               | —           | —    | 1.60 |
| A1                              | 0.05        | —    | 0.15 |
| A2                              | 1.35        | 1.40 | 1.45 |
| D                               | 22.00 BSC   |      |      |
| D1                              | 20.00 BSC   |      |      |
| E                               | 22.00 BSC   |      |      |
| E1                              | 20.00 BSC   |      |      |
| L                               | 0.45        | 0.60 | 0.75 |
| L1                              | 1.00 REF    |      |      |
| S                               | 0.20        | —    | —    |
| b                               | 0.17        | 0.22 | 0.27 |
| c                               | 0.09        | —    | 0.20 |
| e                               | 0.50 BSC    |      |      |
| θ                               | 0°          | 3.5° | 7°   |

**Package Outline**

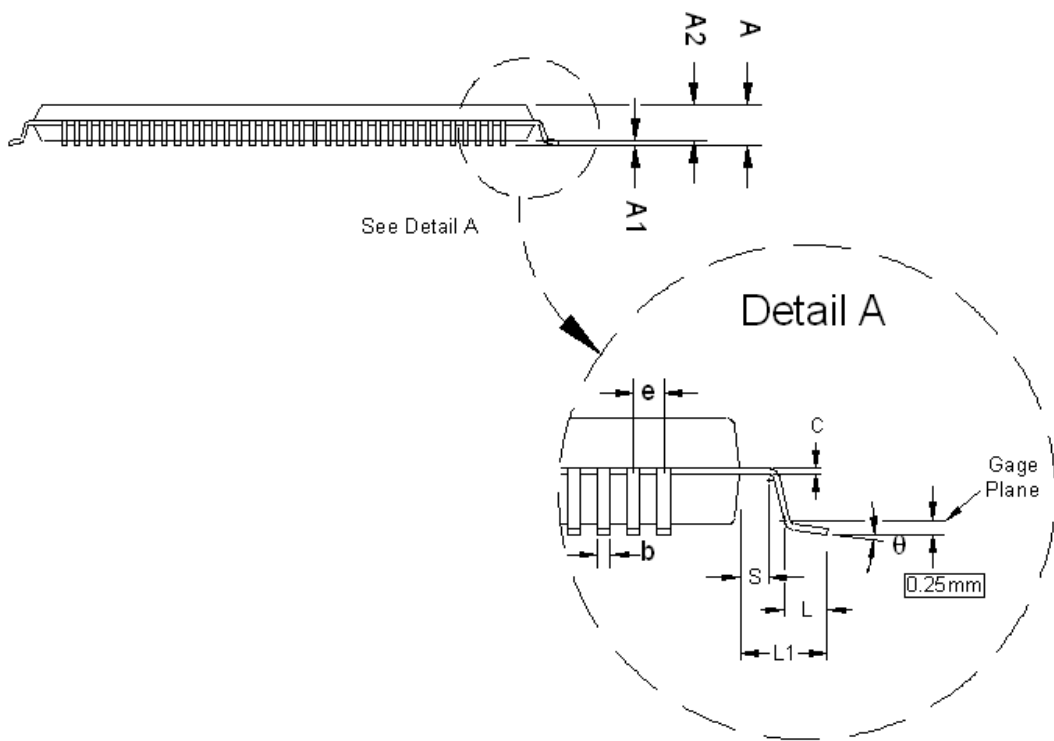
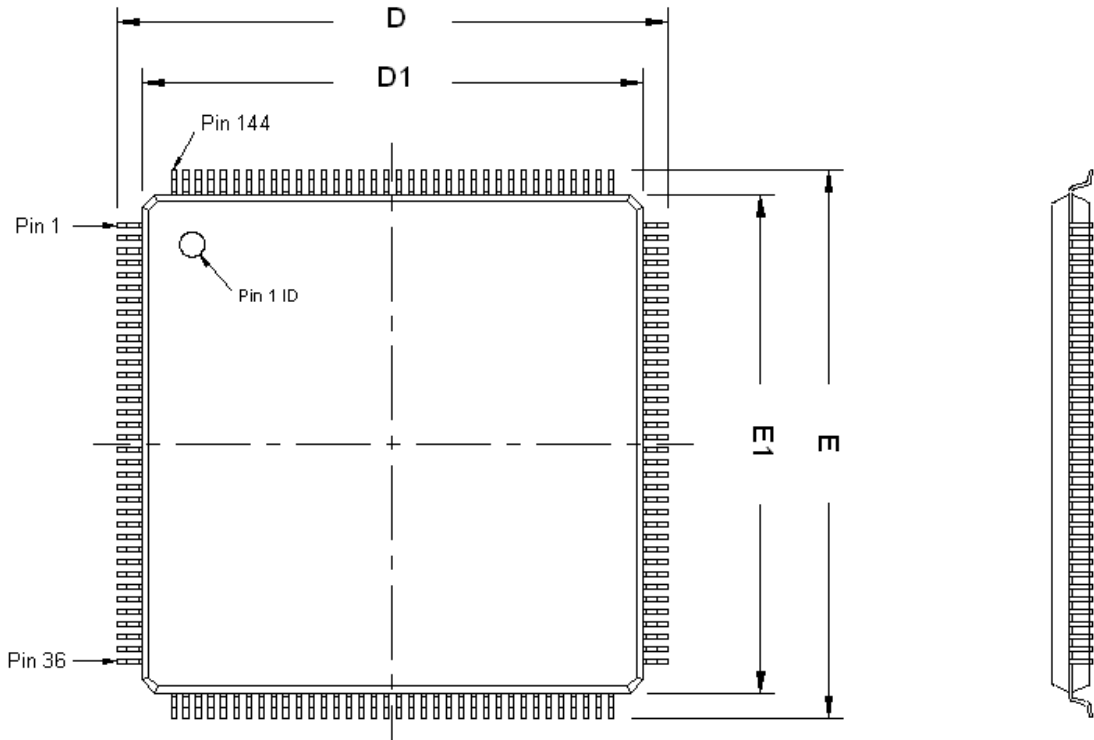

## 160-Pin Ceramic Pin-Grid Array (PGA)—Wire Bond

- All dimensions and tolerances conform to ASME Y14.5M – 1994.
- Controlling dimension is in inches.
- Pin A1 may be indicated by an ID dot, or a special feature, in its proximity on package surface.

| Package Information        |                                 |
|----------------------------|---------------------------------|
| Description                | Specification                   |
| Ordering Code Reference    | G                               |
| Package Acronym            | PGA                             |
| Leadframe Material         | Alloy 42                        |
| Lead Finish                | Gold Over Nickel Plate          |
| JEDEC Outline Reference    | MO-067 Variation: AG            |
| Lead Coplanarity           | N/A                             |
| Weight                     | 19.9 g (Typ.)                   |
| Moisture Sensitivity Level | Printed on moisture barrier bag |

| Package Outline Dimension Table |           |       |       |
|---------------------------------|-----------|-------|-------|
| Symbol                          | Inches    |       |       |
|                                 | Min.      | Nom.  | Max.  |
| A                               | 0.160     | 0.190 | 0.220 |
| A1                              | 0.050 TYP |       |       |
| A2                              | 0.120     | 0.140 | 0.160 |
| D                               | 1.540     | 1.560 | 1.580 |
| E                               | 1.540     | 1.560 | 1.580 |
| L                               | 0.130 TYP |       |       |
| b                               | 0.016     | 0.018 | 0.020 |
| e                               | 0.100 BSC |       |       |

**Package Outline**



## 160-Pin Plastic Quad Flat Pack (PQFP)—Wire Bond

- All dimensions and tolerances conform to ASME Y14.5M – 1994.
- Controlling dimension is in millimeters.
- Pin 1 may be indicated by an ID dot, or a special feature, in its proximity on package surface.

| Package Information        |  |
|----------------------------|--|
| Description                | Specification                                  |
| Ordering Code Reference    | Q  |
| Package Acronym            | PQFP   |
| Leadframe Material         | Copper   |
| Lead Finish (Plating)      | Regular: 85Sn:15Pb (Typ.)<br>Pb-free: Matte Sn |
| JEDEC Outline Reference    | MS-022 Variation: DD-1                         |
| Lead Coplanarity           | 0.004 inches (0.10mm)                          |
| Weight                     | 6.2 g (Typ.)                                   |
| Moisture Sensitivity Level | Printed on moisture barrier bag                |

| Package Outline Dimension Table |             |      |      |
|---------------------------------|-------------|------|------|
| Symbol                          | Millimeters |      |      |
|                                 | Min.        | Nom. | Max. |
| A                               | —           | —    | 4.10 |
| A1                              | 0.25        | —    | 0.50 |
| A2                              | 3.20        | 3.40 | 3.60 |
| D                               | 31.20 BSC   |      |      |
| D1                              | 28.00 BSC   |      |      |
| E                               | 31.20 BSC   |      |      |
| E1                              | 28.00 BSC   |      |      |
| L                               | 0.50        | —    | 1.03 |
| L1                              | 1.60 REF    |      |      |
| S                               | 0.20        | —    | —    |
| b                               | 0.22        | —    | 0.40 |
| c                               | 0.09        | —    | 0.23 |
| e                               | 0.65 BSC    |      |      |
| θ                               | 0°          | —    | 7°   |

## Package Outline

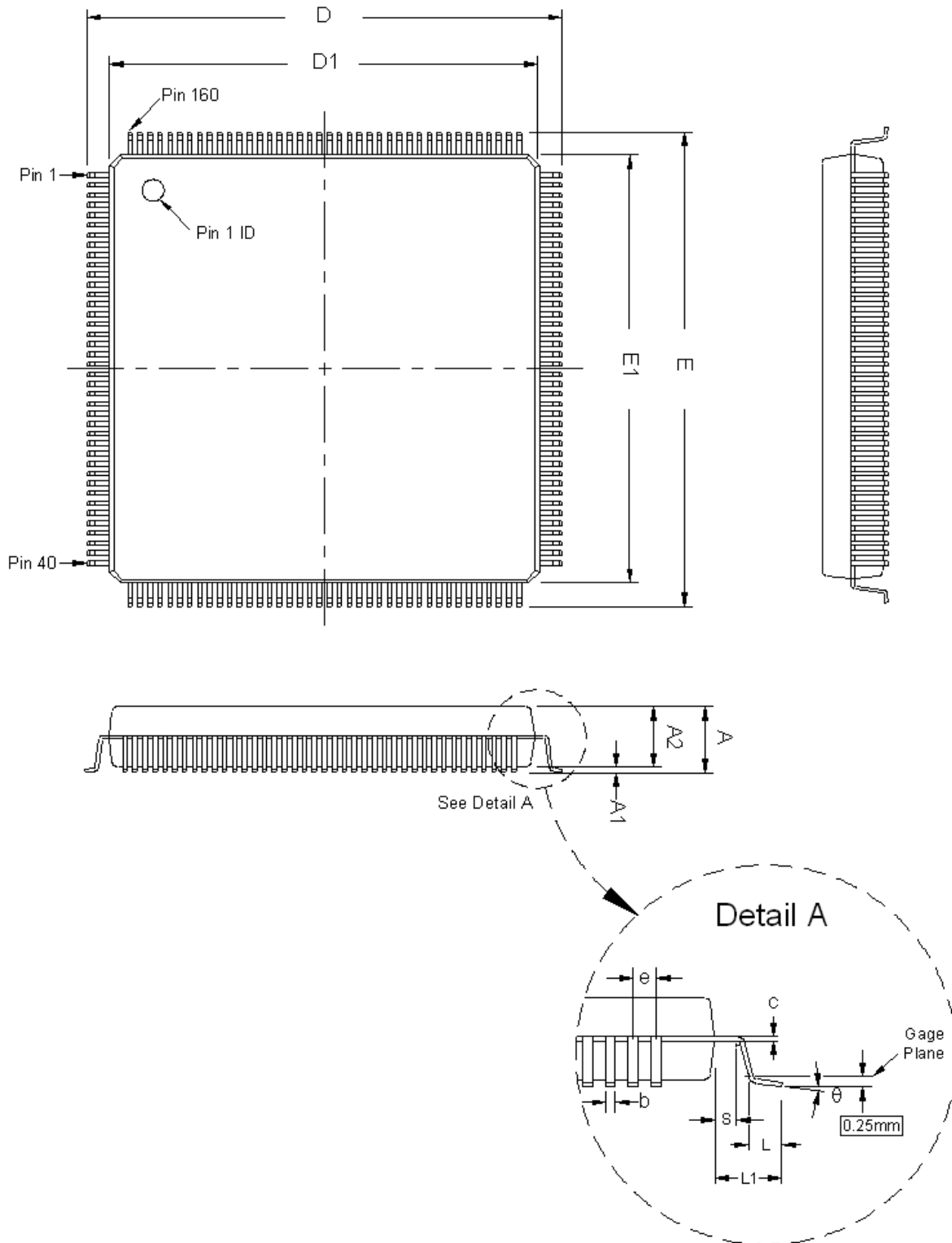

## 169-Pin Ultra FineLine Ball-Grid Array (UBGA)—Wire Bond

- All dimensions and tolerances conform to ASME Y14.5M – 1994.
- Controlling dimension is in millimeters.
- Pin A1 may be indicated by an ID dot, or a special feature, in its proximity on package surface.

| Package Information        |   |
|----------------------------|---|
| Description                | Specification   |
| Ordering Code Reference    | U   |
| Package Acronym            | UBGA  |
| Substrate Material         | BT  |
| Solder Ball Composition    | Regular: 63Sn:37Pb (Typ.)<br>Pb-free: Sn:3Ag:0.5Cu (Typ.) |
| JEDEC Outline Reference    | MO-216 Variation: BAF-1                                   |
| Lead Coplanarity           | 0.005 inches (0.12mm)                                     |
| Weight                     | 0.6 g (Typ.)  |
| Moisture Sensitivity Level | Printed on moisture barrier bag                           |

| Package Outline Dimension Table |             |      |      |
|---------------------------------|-------------|------|------|
| Symbol                          | Millimeters |      |      |
|                                 | Min.        | Nom. | Max. |
| A                               | —           | —    | 1.70 |
| A1                              | 0.20        | —    | —    |
| A2                              | 0.65        | —    | —    |
| A3                              | 0.70 TYP    |      |      |
| D                               | 11.00 BSC   |      |      |
| E                               | 11.00 BSC   |      |      |
| b                               | 0.40        | 0.50 | 0.60 |
| e                               | 0.80 BSC    |      |      |

### Package Outline



## 208-Pin Plastic Quad Flat Pack (PQFP)—Wire Bond

- All dimensions and tolerances conform to ASME Y14.5M - 1994.
- Controlling dimension is in millimeters.
- Pin 1 may be indicated by an ID dot in its proximity on package surface.

| Package Information        |  |
|----------------------------|--|
| Description                | Specification                                  |
| Ordering Code Reference    | Q  |
| Package Acronym            | PQFP   |
| Lead Material              | Copper   |
| Lead Finish (Plating)      | Regular: 85Sn:15Pb (Typ.)<br>Pb-free: Matte Sn |
| JEDEC Outline Reference    | MS-029 Variation: FA-1                         |
| Lead Coplanarity           | 0.003 inches (0.08 mm)                         |
| Weight                     | 6.3 g (Typ.)                                   |
| Moisture Sensitivity Level | Printed on moisture barrier bag                |

| Package Outline Dimension Table |             |      |      |
|---------------------------------|-------------|------|------|
| Symbol                          | Millimeters |      |      |
|                                 | Min.        | Nom. | Max. |
| A                               | —           | —    | 4.10 |
| A1                              | 0.25        | —    | 0.50 |
| A2                              | 3.20        | 3.40 | 3.60 |
| D                               | 30.60 BSC   |      |      |
| D1                              | 28.00 BSC   |      |      |
| E                               | 30.60 BSC   |      |      |
| E1                              | 28.00 BSC   |      |      |
| L                               | 0.50        | 0.60 | 0.75 |
| L1                              | 1.30 REF    |      |      |
| S                               | 0.20        | —    | —    |
| b                               | 0.17        | —    | 0.27 |
| c                               | 0.09        | —    | 0.20 |
| e                               | 0.50 BSC    |      |      |
| θ                               | 0°          | 3.5° | 8°   |

## Package Outline

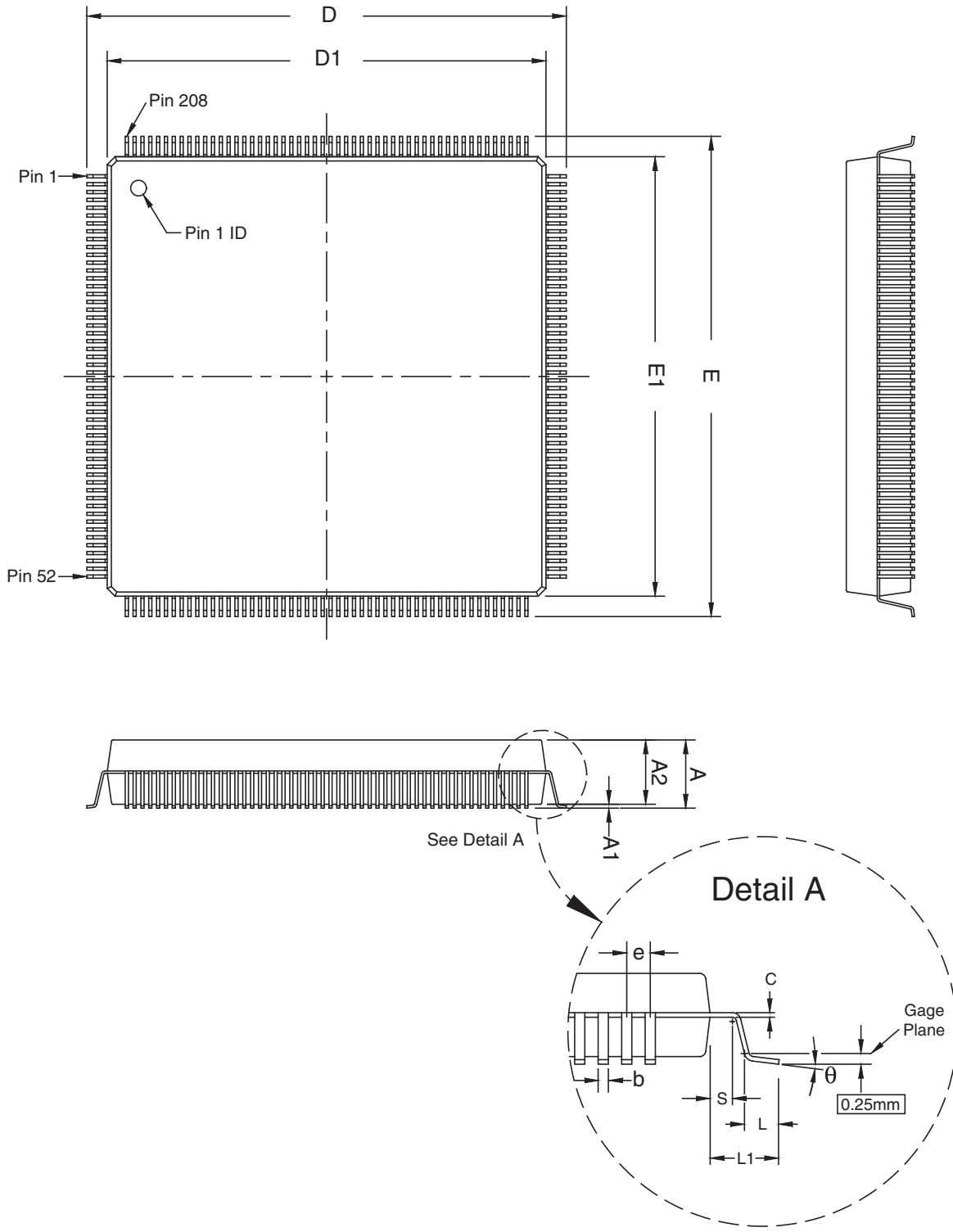

## 208-Pin Power Quad Flat Pack (RQFP)—Wire Bond

- All dimensions and tolerances conform to ASME Y14.5M – 1994.
- Controlling dimension is in millimeters.
- Pin 1 may be indicated by an ID dot, or a special feature, in its proximity on package surface.

| Package Information        |  |
|----------------------------|--|
| Description                | Specification                                  |
| Ordering Code Reference    | R  |
| Package Acronym            | RQFP   |
| Leadframe Material         | Copper   |
| Lead Finish (Plating)      | Regular: 85Sn:15Pb (Typ.)<br>Pb-free: Matte Sn |
| JEDEC Outline Reference    | MS-029 Variation: FA-1                         |
| Lead Coplanarity           | 0.003 inches (0.08mm)                          |
| Weight                     | 11.0 g (Typ.) or 6.4 g (Typ.) (1)              |
| Moisture Sensitivity Level | Printed on moisture barrier bag                |

**Note:**

- (1) The lighter weight is due to the change in heat slug material used (from nickel-plated copper to anodized aluminum). Refer to PCN1002.

| Package Outline Dimension Table |             |      |      |
|---------------------------------|-------------|------|------|
| Symbol                          | Millimeters |      |      |
|                                 | Min.        | Nom. | Max. |
| A                               | —           | —    | 4.10 |
| A1                              | 0.25        | —    | 0.50 |
| A2                              | 3.20        | 3.40 | 3.60 |
| D                               | 30.60 BSC   |      |      |
| D1                              | 28.00 BSC   |      |      |
| E                               | 30.60 BSC   |      |      |
| E1                              | 28.00 BSC   |      |      |
| L                               | 0.45        | 0.60 | 0.75 |
| L1                              | 1.30 REF    |      |      |
| S                               | 0.20        | —    | —    |
| b                               | 0.17        | —    | 0.27 |
| c                               | 0.09        | —    | 0.20 |
| e                               | 0.50 BSC    |      |      |
| θ                               | 0°          | 3.5° | 8°   |

### Package Outline



## 240-Pin Plastic Quad Flat Pack (PQFP)—Wire Bond

- All dimensions and tolerances conform to ASME Y14.5M – 1994.
- Controlling dimension is in millimeters.
- Pin 1 may be indicated by an ID dot, or a special feature, in its proximity on package surface.

| Package Information        |  |
|----------------------------|--|
| Description                | Specification                                  |
| Ordering Code Reference    | Q  |
| Package Acronym            | PQFP   |
| Leadframe Material         | Copper   |
| Lead Finish (Plating)      | Regular: 85Sn:15Pb (Typ.)<br>Pb-free: Matte Sn |
| JEDEC Outline Reference    | MS-029 Variation: GA                           |
| Lead Coplanarity           | 0.003 inches (0.08mm)                          |
| Weight                     | 8.0 g (Typ.)                                   |
| Moisture Sensitivity Level | Printed on moisture barrier bag                |

| Package Outline Dimension Table |             |      |      |
|---------------------------------|-------------|------|------|
| Symbol                          | Millimeters |      |      |
|                                 | Min.        | Nom. | Max. |
| A                               | —           | —    | 4.10 |
| A1                              | 0.25        | —    | 0.50 |
| A2                              | 3.20        | 3.40 | 3.60 |
| D                               | 34.60 BSC   |      |      |
| D1                              | 32.00 BSC   |      |      |
| E                               | 34.60 BSC   |      |      |
| E1                              | 32.00 BSC   |      |      |
| L                               | 0.45        | 0.60 | 0.75 |
| L1                              | 1.30 REF    |      |      |
| S                               | 0.20        | —    | —    |
| b                               | 0.17        | —    | 0.27 |
| c                               | 0.09        | —    | 0.20 |
| e                               | 0.50 BSC    |      |      |
| θ                               | 0°          | 3.5° | 8°   |

**Package Outline**



See Detail A

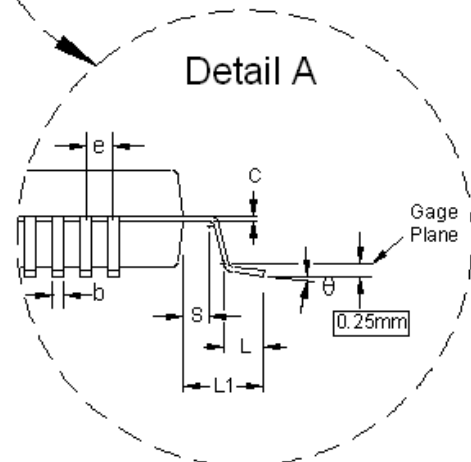

## 240-Pin Power Quad Flat Pack (RQFP)—Wire Bond

- All dimensions and tolerances conform to ASME Y14.5M – 1994.
- Controlling dimension is in millimeters.
- Pin 1 may be indicated by an ID dot, or a special feature, in its proximity on package surface.

| Package Information        |  |
|----------------------------|--|
| Description                | Specification                                  |
| Ordering Code Reference    | R  |
| Package Acronym            | RQFP   |
| Leadframe Material         | Copper   |
| Lead Finish (Plating)      | Regular: 85Sn:15Pb (Typ.)<br>Pb-free: Matte Sn |
| JEDEC Outline Reference    | MS-029 Variation: GA                           |
| Lead Coplanarity           | 0.003 inches (0.08mm)                          |
| Weight                     | 15.4 g (Typ.) or 8.5 g (Typ.) (1)              |
| Moisture Sensitivity Level | Printed on moisture barrier bag                |

**Note:**

- (1) The lighter weight is due to the change in heat slug material used (from nickel-plated copper to anodized aluminum). Refer to PCN1002.

| Package Outline Dimension Table |             |      |      |
|---------------------------------|-------------|------|------|
| Symbol                          | Millimeters |      |      |
|                                 | Min.        | Nom. | Max. |
| A                               | —           | —    | 4.10 |
| A1                              | 0.25        | —    | 0.50 |
| A2                              | 3.20        | 3.40 | 3.60 |
| D                               | 34.60 BSC   |      |      |
| D1                              | 32.00 BSC   |      |      |
| E                               | 34.60 BSC   |      |      |
| E1                              | 32.00 BSC   |      |      |
| L                               | 0.45        | 0.60 | 0.75 |
| L1                              | 1.30 REF    |      |      |
| S                               | 0.20        | —    | —    |
| b                               | 0.17        | —    | 0.27 |
| c                               | 0.09        | —    | 0.20 |
| e                               | 0.50 BSC    |      |      |
| θ                               | 0°          | 3.5° | 8°   |

### Package Outline

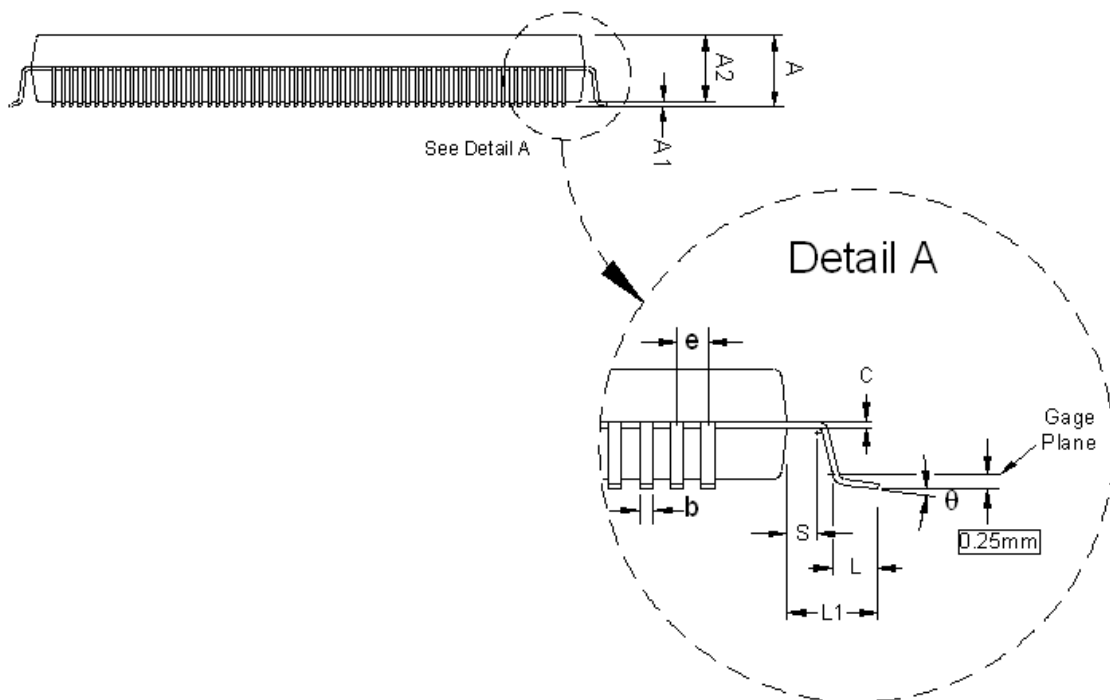
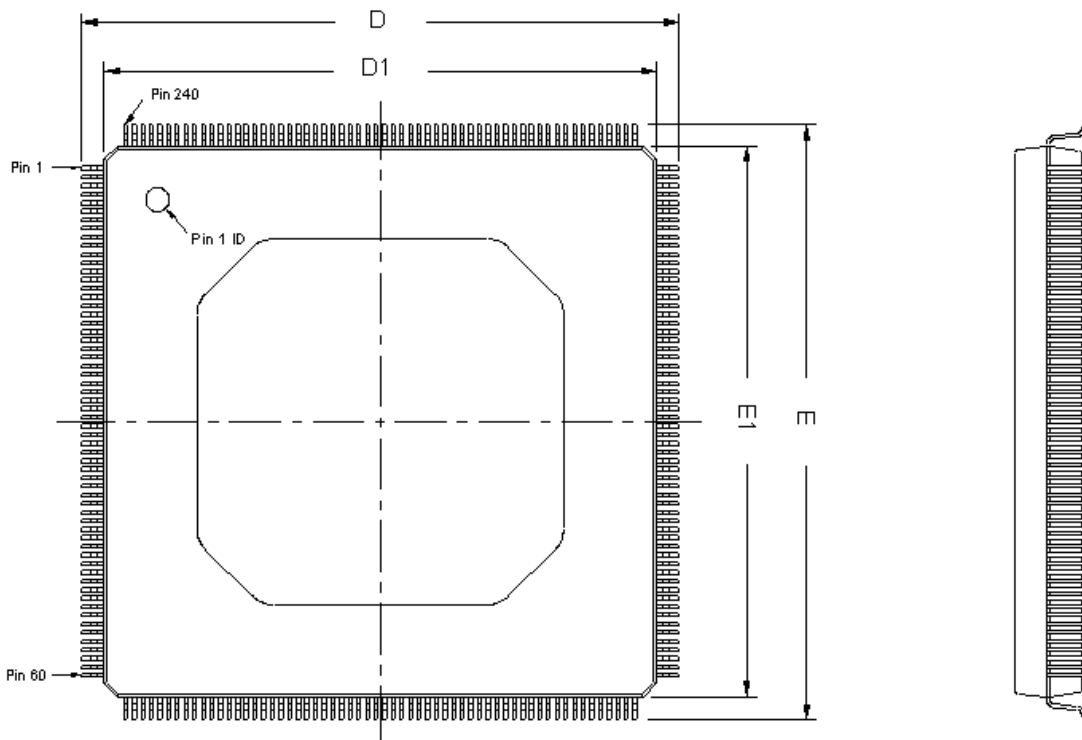

## 256-Pin Ball-Grid Array (BGA), Option 1—Wire Bond

- All dimensions and tolerances conform to ASME Y14.5M - 1994.
- Controlling dimension is in millimeters.
- Pin A1 may be indicated by an ID dot, or a special feature, in its proximity on package surface.

| Package Information        |   |
|----------------------------|---|
| Description                | Specification   |
| Ordering Code Reference    | B   |
| Package Acronym            | BGA   |
| Substrate Material         | BT or tape  |
| Solder Ball Composition    | Regular: 63Sn:37Pb (Typ.)<br>Pb-free: Sn:3Ag:0.5Cu (Typ.) |
| JEDEC Outline Reference    | MO-192 Variation: BAL-2                                   |
| Lead Coplanarity           | 0.008 inches (0.20 mm)                                    |
| Weight                     | 4.8 g (Typ.)  |
| Moisture Sensitivity Level | Printed on moisture barrier bag                           |

| Package Outline Dimension Table |             |      |      |
|---------------------------------|-------------|------|------|
| Symbol                          | Millimeters |      |      |
|                                 | Min.        | Nom. | Max. |
| A                               | —           | —    | 1.70 |
| A1                              | 0.35        | —    | —    |
| A2                              | 0.25        | —    | 1.10 |
| D                               | 27.00 BSC   |      |      |
| E                               | 27.00 BSC   |      |      |
| b                               | 0.60        | 0.75 | 0.90 |
| e                               | 1.27 BSC    |      |      |

### Package Outline



## 256-Pin Plastic Ball-Grid Array (BGA), Option 2—Wire Bond

- All dimensions and tolerances conform to ASME Y14.5M - 1994.
- Controlling dimension is in millimeters.
- Pin A1 may be indicated by an ID dot, or a special feature, in its proximity on package surface.

| Package Information        |   |
|----------------------------|---|
| Description                | Specification   |
| Ordering Code Reference    | B   |
| Package Acronym            | BGA   |
| Substrate Material         | BT  |
| Solder Ball Composition    | Regular: 63Sn:37Pb (Typ.)<br>Pb-free: Sn:3Ag:0.5Cu (Typ.) |
| JEDEC Outline Reference    | MS-034 Variation: BAL-2                                   |
| Lead Coplanarity           | 0.008 inches (0.20 mm)                                    |
| Weight                     | 2.2 g (Typ.)  |
| Moisture Sensitivity Level | Printed on moisture barrier bag                           |

| Package Outline Dimension Table |             |      |      |
|---------------------------------|-------------|------|------|
| Symbol                          | Millimeters |      |      |
|                                 | Min.        | Nom. | Max. |
| A                               | —           | —    | 2.60 |
| A1                              | 0.35        | —    | —    |
| A2                              | —           | —    | 2.20 |
| A3                              | —           | —    | 1.80 |
| D                               | 27.00 BSC   |      |      |
| E                               | 27.00 BSC   |      |      |
| b                               | 0.60        | 0.75 | 0.90 |
| e                               | 1.27 BSC    |      |      |

**Package Outline**



## 256-Pin FineLine Ball-Grid Array (FBGA), Option 1—Wire Bond

- All dimensions and tolerances conform to ASME Y14.5M - 1994.
- Controlling dimension is in millimeters.
- Pin A1 may be indicated by an ID dot, or a special feature, in its proximity on package surface.



This POD is applicable to F256 packages of all products listed in this datasheet except Cyclone II, which are assembled in Option 2 package outlines.

| Package Information        |   |
|----------------------------|---|
| Description                | Specification   |
| Ordering Code Reference    | F   |
| Package Acronym            | FBGA  |
| Substrate Material         | BT  |
| Solder Ball Composition    | Regular: 63Sn:37Pb (Typ.)<br>Pb-free: Sn:3Ag:0.5Cu (Typ.) |
| JEDEC Outline Reference    | MS-034 Variation: AAF-1                                   |
| Lead Coplanarity           | 0.008 inches (0.20 mm)                                    |
| Weight                     | 1.5 g (Typ.)  |
| Moisture Sensitivity Level | Printed on moisture barrier bag                           |

| Package Outline Dimension Table |             |      |      |
|---------------------------------|-------------|------|------|
| Symbol                          | Millimeters |      |      |
|                                 | Min.        | Nom. | Max. |
| A                               | —           | —    | 2.20 |
| A1                              | 0.30        | —    | —    |
| A2                              | —           | —    | 1.80 |
| A3                              | 0.70 REF    |      |      |
| D                               | 17.00 BSC   |      |      |
| E                               | 17.00 BSC   |      |      |
| b                               | 0.50        | 0.60 | 0.70 |
| e                               | 1.00 BSC    |      |      |

**Package Outline**



## 256-Pin FineLine Ball-Grid Array (FBGA), Option 2—Thin—Wire Bond

- All dimensions and tolerances conform to ASME Y14.5M - 1994.
- Controlling dimension is in millimeters.
- Pin A1 may be indicated by an ID dot, or a special feature, in its proximity on the package surface.



This POD is applicable to F256 packages of the Cyclone II devices only.

| Package Information        |   |
|----------------------------|---|
| Description                | Specification   |
| Ordering Code Reference    | F   |
| Package Acronym            | FBGA  |
| Substrate Material         | BT  |
| Solder Ball Composition    | Regular: 63Sn:37Pb (Typ.)<br>Pb-free: Sn:3Ag:0.5Cu (Typ.) |
| JEDEC Outline Reference    | MO-192 Variation: DAF-1                                   |
| Lead Coplanarity           | 0.008 inches (0.20 mm)                                    |
| Weight                     | 1.5 g (Typ.)  |
| Moisture Sensitivity Level | Printed on moisture barrier bag                           |

| Package Outline Dimension Table |             |      |      |
|---------------------------------|-------------|------|------|
| Symbol                          | Millimeters |      |      |
|                                 | Min.        | Nom. | Max. |
| A                               | —           | —    | 1.55 |
| A1                              | 0.25        | —    | —    |
| A2                              | 1.05 REF    |      |      |
| A3                              | —           | —    | 0.80 |
| D                               | 17.00 BSC   |      |      |
| E                               | 17.00 BSC   |      |      |
| b                               | 0.45        | 0.50 | 0.55 |
| e                               | 1.00 BSC    |      |      |

### Package Outline



### 324-Pin FineLine Ball-Grid Array (FBGA)—Wire Bond—Option 1

- All dimensions and tolerances conform to ASME Y14.5M – 1994.
- Controlling dimension is in millimeters.
- Pin A1 may be indicated by an ID dot, or a special feature, in its proximity on package surface.

| Package Information        |   |
|----------------------------|---|
| Description                | Specification   |
| Ordering Code Reference    | F   |
| Package Acronym            | FBGA  |
| Substrate Material         | BT  |
| Solder Ball Composition    | Regular: 63Sn:37Pb (Typ.)<br>Pb-free: Sn:3Ag:0.5Cu (Typ.) |
| JEDEC Outline Reference    | MS-034 Variation: AAG-1                                   |
| Lead Coplanarity           | 0.008 inches (0.20mm)                                     |
| Weight                     | 1.4 g (Typ.)  |
| Moisture Sensitivity Level | Printed on moisture barrier bag                           |

| Package Outline Dimension Table |             |      |      |
|---------------------------------|-------------|------|------|
| Symbol                          | Millimeters |      |      |
|                                 | Min.        | Nom. | Max. |
| A                               | —           | —    | 2.20 |
| A1                              | 0.30        | —    | —    |
| A2                              | —           | —    | 1.80 |
| A3                              | 0.70 REF    |      |      |
| D                               | 19.00 BSC   |      |      |
| E                               | 19.00 BSC   |      |      |
| b                               | 0.50        | 0.60 | 0.70 |
| e                               | 1.00 BSC    |      |      |

**Package Outline**



### 356-Pin Ball-Grid Array (BGA)—Wire Bond

- All dimensions and tolerances conform to ASME Y14.5M – 1994.
- Controlling dimension is in millimeters.
- Pin A1 may be indicated by an ID dot, or a special feature, in its proximity on package surface.

| Package Information        |   |
|----------------------------|---|
| Description                | Specification   |
| Ordering Code Reference    | B   |
| Package Acronym            | BGA   |
| Substrate Material         | BT or tape  |
| Solder Ball Composition    | Regular: 63Sn:37Pb (Typ.)<br>Pb-free: Sn:3Ag:0.5Cu (Typ.) |
| JEDEC Outline Reference    | MO-192 Variation: BAR-2                                   |
| Lead Coplanarity           | 0.008 inches (0.20mm)                                     |
| Weight                     | 7.7 g (Typ.)  |
| Moisture Sensitivity Level | Printed on moisture barrier bag                           |

| Package Outline Dimension Table |             |      |      |
|---------------------------------|-------------|------|------|
| Symbol                          | Millimeters |      |      |
|                                 | Min.        | Nom. | Max. |
| A                               | —           | —    | 1.70 |
| A1                              | 0.35        | —    | —    |
| A2                              | 0.25        | —    | 1.10 |
| D                               | 35.00 BSC   |      |      |
| E                               | 35.00 BSC   |      |      |
| b                               | 0.60        | 0.75 | 0.90 |
| e                               | 1.27 BSC    |      |      |

**Package Outline**

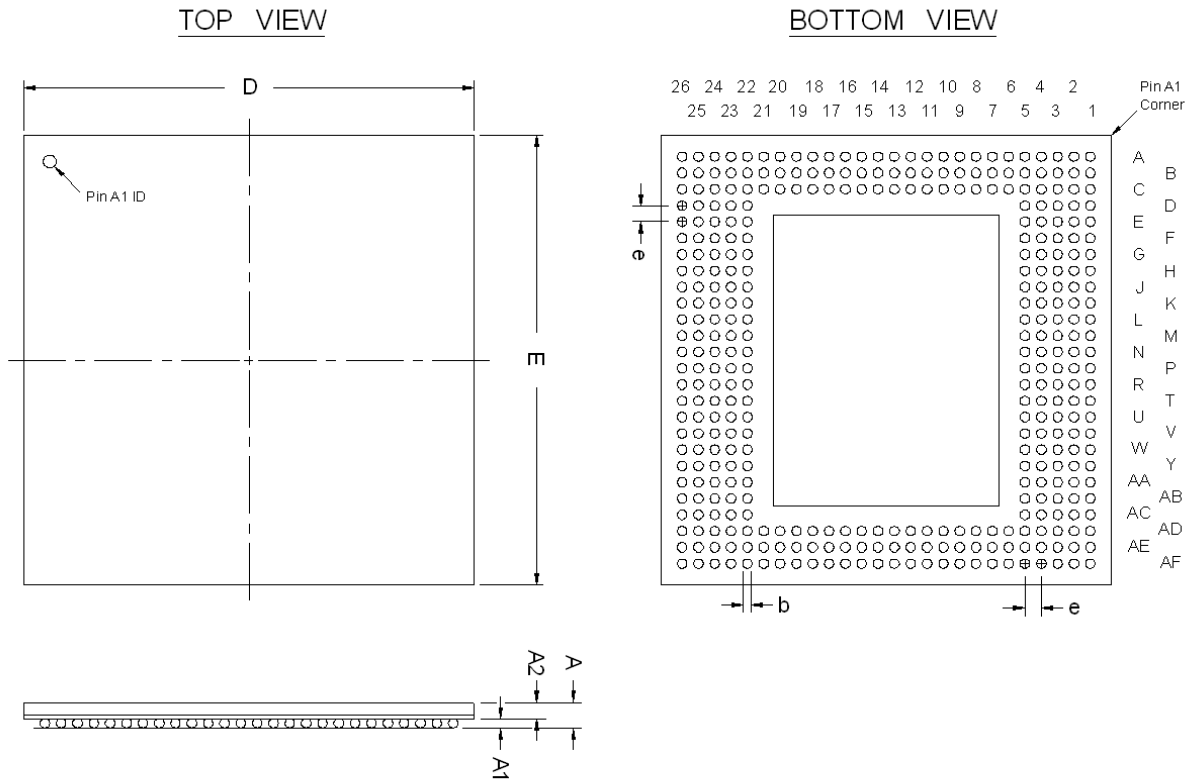

## 400-Pin FineLine Ball-Grid Array (FBGA)—Wire Bond

- All dimensions and tolerances conform to ASME Y14.5M – 1994.
- Controlling dimension is in millimeters.
- Pin A1 may be indicated by an ID dot, or a special feature, in its proximity on package surface.

| Package Information        |   |
|----------------------------|---|
| Description                | Specification   |
| Ordering Code Reference    | F   |
| Package Acronym            | FBGA  |
| Substrate Material         | BT  |
| Solder Ball Composition    | Regular: 63Sn:37Pb (Typ.)<br>Pb-free: Sn:3Ag:0.5Cu (Typ.) |
| JEDEC Outline Reference    | MS-034 Variation: AAH-1                                   |
| Lead Coplanarity           | 0.008 inches (0.20mm)                                     |
| Weight                     | 2.3 g (Typ.)  |
| Moisture Sensitivity Level | Printed on moisture barrier bag                           |

| Package Outline Dimension Table |              |      |      |
|---------------------------------|--------------|------|------|
| Symbol                          | Millimeteres |      |      |
|                                 | Min.         | Nom. | Max. |
| A                               | —            | —    | 2.20 |
| A1                              | 0.30         | —    | —    |
| A2                              | —            | —    | 1.80 |
| A3                              | 0.80 REF     |      |      |
| D                               | 21.00 BSC    |      |      |
| E                               | 21.00 BSC    |      |      |
| b                               | 0.50         | 0.60 | 0.70 |
| e                               | 1.00 BSC     |      |      |

**Package Outline**

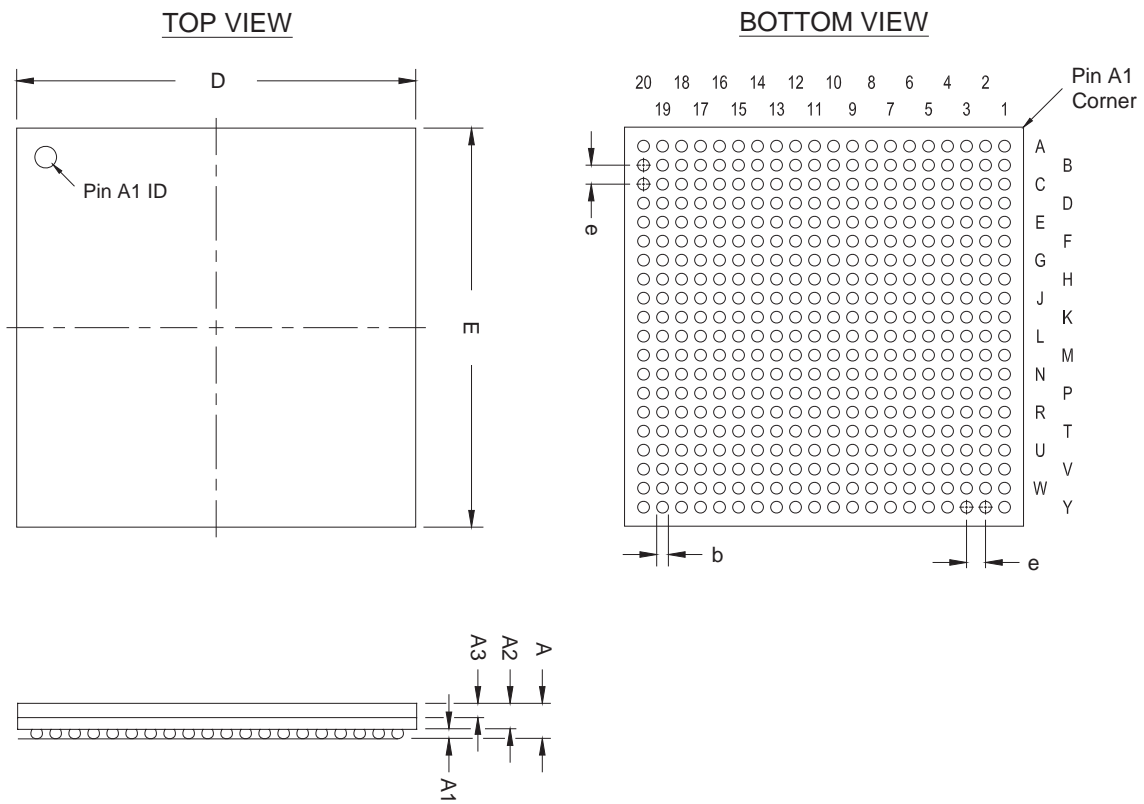

## 403-Pin Ceramic Pin-Grid Array (PGA)—Wire Bond

- All dimensions and tolerances conform to ASME Y14.5M – 1994.
- Controlling dimension is in inches.
- Pin A1 may be indicated by an ID dot, or a special feature, in its proximity on package surface.

| Package Information        |                                 |
|----------------------------|---------------------------------|
| Description                | Specification                   |
| Ordering Code Reference    | G                               |
| Package Acronym            | PGA                             |
| Leadframe Material         | Alloy 42                        |
| Lead Finish                | Gold Over Nickel Plate          |
| JEDEC Outline Reference    | MO-128 Variation: AL            |
| Lead Coplanarity           | N/A                             |
| Weight                     | 47.7 g (Typ.)                   |
| Moisture Sensitivity Level | Printed on moisture barrier bag |

| Package Outline Dimension Table |           |       |       |
|---------------------------------|-----------|-------|-------|
| Symbol                          | Inches    |       |       |
|                                 | Min.      | Nom.  | Max.  |
| A                               | 0.157     | 0.180 | 0.203 |
| A1                              | 0.050 TYP |       |       |
| A2                              | 0.117     | 0.130 | 0.143 |
| D                               | 1.940     | 1.960 | 1.980 |
| E                               | 1.940     | 1.960 | 1.980 |
| L                               | 0.130 TYP |       |       |
| b                               | 0.016     | 0.018 | 0.020 |
| e                               | 0.100 BSC |       |       |

**Package Outline**

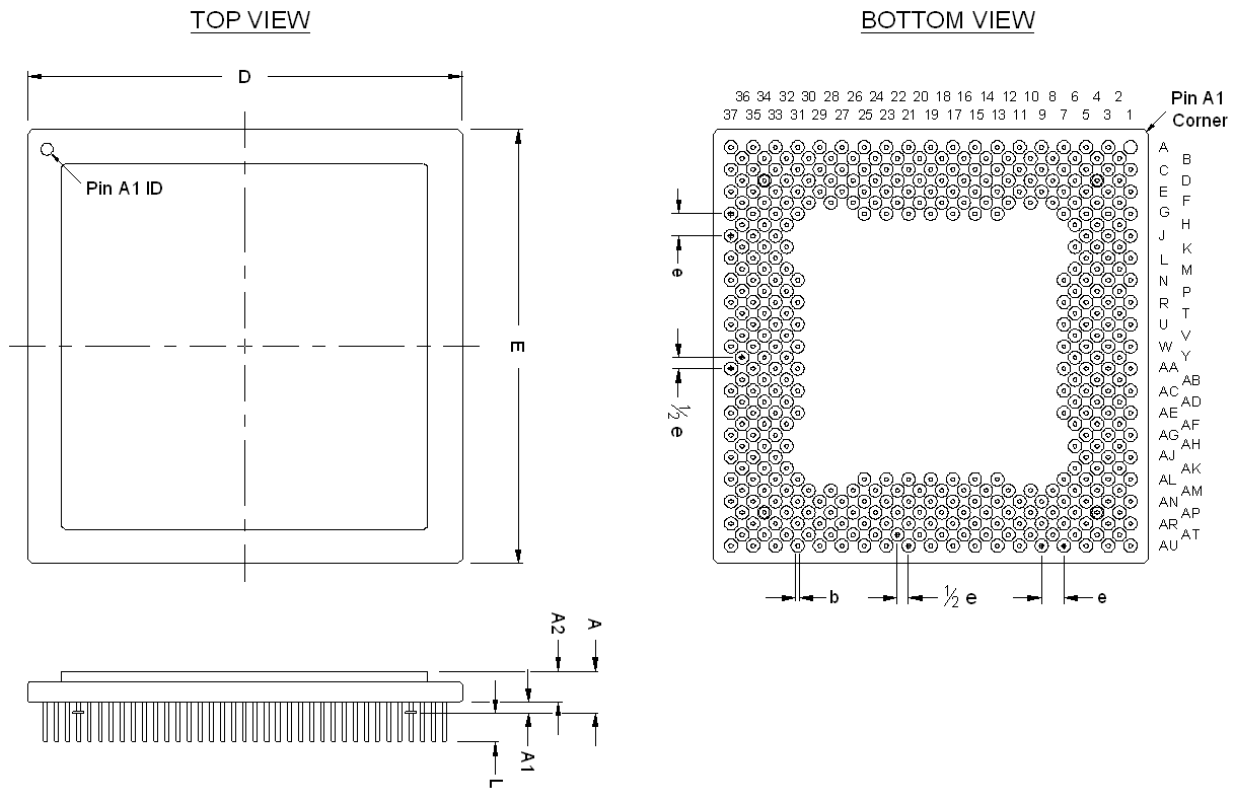

## 484-Pin FineLine Ball-Grid Array (FBGA), Option 1—Flip Chip

- All dimensions and tolerances conform to ASME Y14.5M – 1994.
- Controlling dimension is in millimeters.
- Pin A1 may be indicated by an ID dot, or a special feature, in its proximity on the package surface.

| Package Information        |   |
|----------------------------|---|
| Description                | Specification   |
| Ordering Code Reference    | F   |
| Package Acronym            | FBGA  |
| Substrate Material         | BT  |
| Solder Ball Composition    | Regular: 63Sn:37Pb (Typ.)<br>Pb-free: Sn:3Ag:0.5Cu (Typ.) |
| JEDEC Outline Reference    | MS-034 Variation: AAJ-1                                   |
| Lead Coplanarity           | 0.008 inches (0.20 mm)                                    |
| Weight                     | 6.8 g (Typ.)  |
| Moisture Sensitivity Level | Printed on moisture barrier bag                           |

| Package Outline Dimension Table |             |      |      |
|---------------------------------|-------------|------|------|
| Symbol                          | Millimeters |      |      |
|                                 | Min.        | Nom. | Max. |
| A                               | —           | —    | 3.50 |
| A1                              | 0.30        | —    | —    |
| A2                              | 0.25        | —    | 3.00 |
| A3                              | —           | —    | 2.50 |
| D                               | 23.00 BSC   |      |      |
| E                               | 23.00 BSC   |      |      |
| b                               | 0.50        | 0.60 | 0.70 |
| e                               | 1.00 BSC    |      |      |

**Package Outline**



## 484-Pin FineLine Ball-Grid Array (FBGA), Option 1—Flip Chip—Channel Lid

- All dimensions and tolerances conform to ASME Y14.5M – 1994.
- Controlling dimension is in millimeters.
- Pin A1 may be indicated by an ID dot, or a special feature, in its proximity on the package surface.

| Package Information        |   |
|----------------------------|---|
| Description                | Specification   |
| Ordering Code Reference    | F   |
| Package Acronym            | FBGA  |
| Substrate Material         | BT  |
| Solder Ball Composition    | Regular: 63Sn:37Pb (Typ.)<br>Pb-free: Sn:3Ag:0.5Cu (Typ.) |
| JEDEC Outline Reference    | MO-034 Variation: AAJ-1                                   |
| Lead Coplanarity           | 0.008 inches (0.20 mm)                                    |
| Weight                     | 6.8 g (Typ.)  |
| Moisture Sensitivity Level | Printed on moisture barrier bag                           |

| Package Outline Dimension Table |             |      |      |
|---------------------------------|-------------|------|------|
| Symbol                          | Millimeters |      |      |
|                                 | Min.        | Nom. | Max. |
| A                               | 2.95        | 3.15 | 3.35 |
| A1                              | 0.40        | 0.50 | 0.60 |
| A2                              | 2.35        | 2.65 | 2.95 |
| A3                              | 1.35        | 1.45 | 1.55 |
| D                               | 23.00 BSC   |      |      |
| E                               | 23.00 BSC   |      |      |
| b                               | 0.50        | 0.60 | 0.70 |
| e                               | 1.00 BSC    |      |      |

**Package Outline**

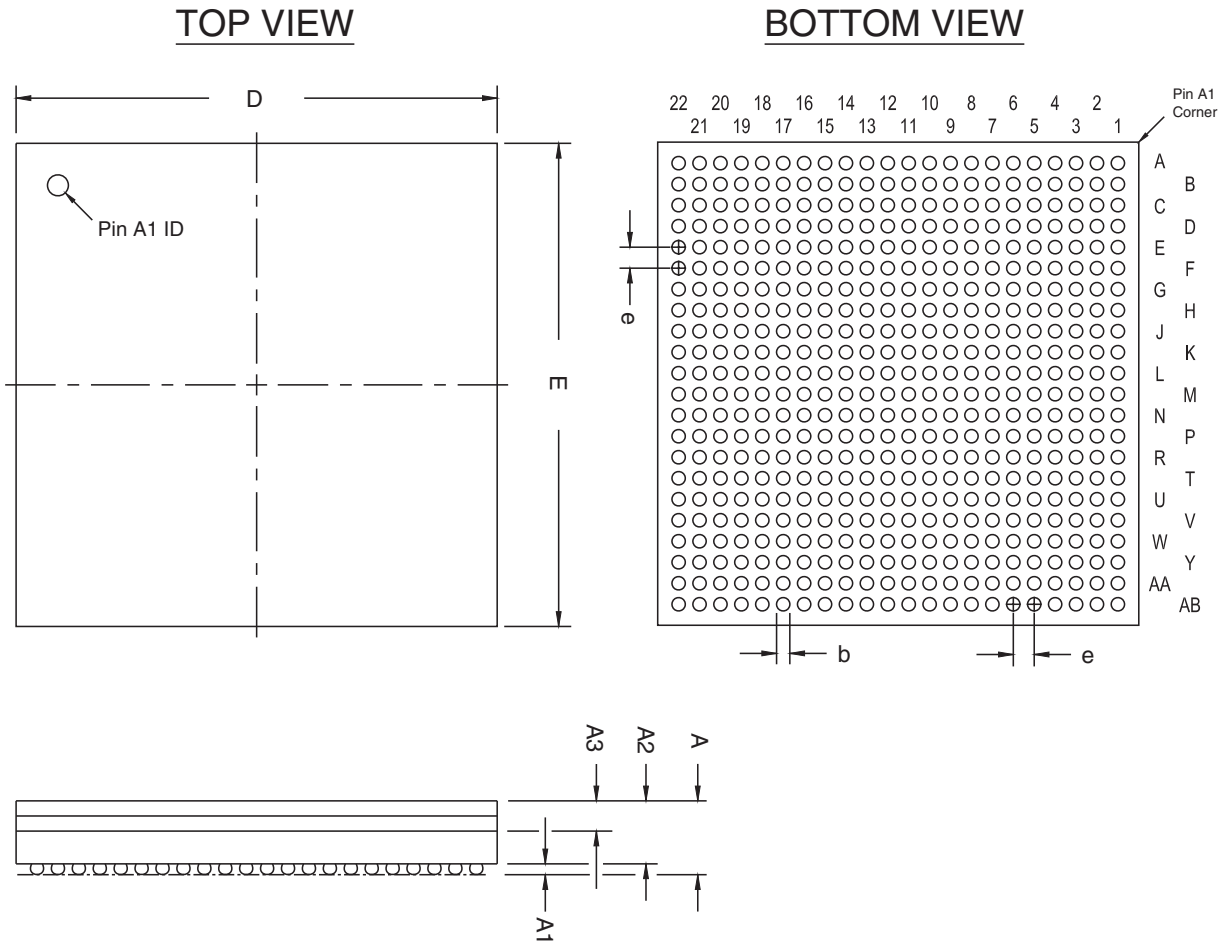

## 484-Pin FineLine Ball-Grid Array (FBGA), Option 2—Wire Bond

- All dimensions and tolerances conform to ASME Y14.5M – 1994.
- Controlling dimension is in millimeters.
- Pin A1 may be indicated by an ID dot, or a special feature, in its proximity on package surface.

| Package Information        |   |
|----------------------------|---|
| Description                | Specification   |
| Ordering Code Reference    | F   |
| Package Acronym            | FBGA  |
| Substrate Material         | BT  |
| Solder Ball Composition    | Regular: 63Sn:37Pb (Typ.)<br>Pb-free: Sn:3Ag:0.5Cu (Typ.) |
| JEDEC Outline Reference    | MS-034 Variation: AAJ-1                                   |
| Lead Coplanarity           | 0.008 inches (0.20 mm)                                    |
| Weight                     | 2.6 g (Typ.)  |
| Moisture Sensitivity Level | Printed on moisture barrier bag                           |

| Package Outline Dimension Table |             |      |      |
|---------------------------------|-------------|------|------|
| Symbol                          | Millimeters |      |      |
|                                 | Min.        | Nom. | Max. |
| A                               | —           | —    | 2.60 |
| A1                              | 0.30        | —    | —    |
| A2                              | —           | —    | 2.20 |
| A3                              | —           | —    | 1.80 |
| D                               | 23.00 BSC   |      |      |
| E                               | 23.00 BSC   |      |      |
| b                               | 0.50        | 0.60 | 0.70 |
| e                               | 1.00 BSC    |      |      |

**Package Outline**

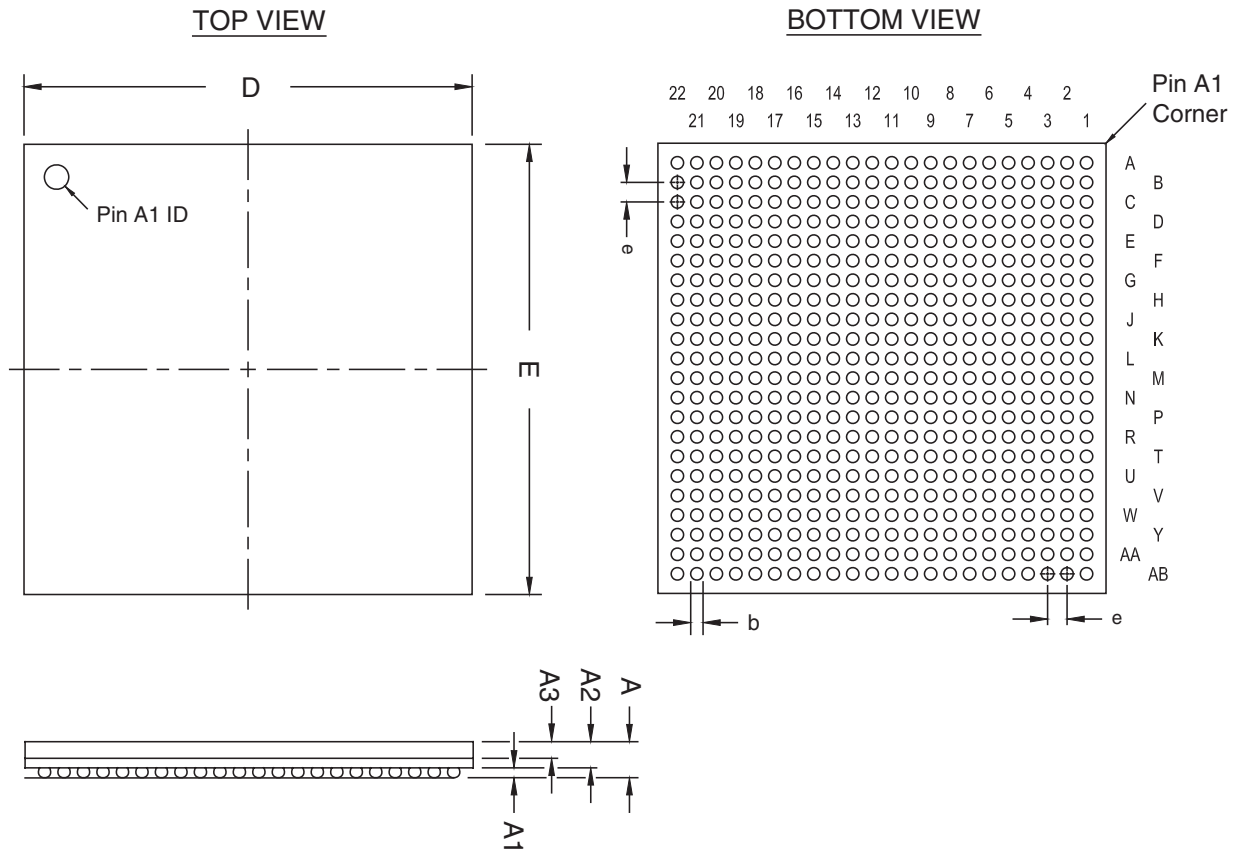

## 484-Pin FineLine Ball-Grid Array (FBGA), Option 4—Flip Chip

- All dimensions and tolerances conform to ASME Y14.5M – 1994.
- Controlling dimension is in millimeters.
- Pin A1 may be indicated by an ID dot, or a special feature, in its proximity on package surface.

| Package Information        |   |
|----------------------------|---|
| Description                | Specification   |
| Ordering Code Reference    | F   |
| Package Acronym            | FBGA  |
| Substrate Material         | BT  |
| Solder Ball Composition    | Regular: 63Sn:37Pb (Typ.)<br>Pb-free: Sn:3Ag:0.5Cu (Typ.) |
| JEDEC Outline Reference    | MS-034 Variation: AAJ-1                                   |
| Lead Coplanarity           | 0.008 inches (0.20 mm)                                    |
| Weight                     | 5.3 g (Typ.)  |
| Moisture Sensitivity Level | Printed on moisture barrier bag                           |

| Package Outline Dimension Table |             |      |      |
|---------------------------------|-------------|------|------|
| Symbol                          | Millimeters |      |      |
|                                 | Min.        | Nom. | Max. |
| A                               | —           | —    | 3.50 |
| A1                              | 0.30        | —    | —    |
| A2                              | 0.25        | —    | 3.00 |
| A3                              | —           | —    | 2.50 |
| D                               | 23.00 BSC   |      |      |
| D1                              | 17.00 BSC   |      |      |
| E                               | 23.00 BSC   |      |      |
| E1                              | 17.00 BSC   |      |      |
| b                               | 0.50        | 0.60 | 0.70 |
| e                               | 1.00 BSC    |      |      |

**Package Outline**



## 484-Pin FineLine Ball-Grid Array (FBGA)—Wire Bond—A:2.40

- All dimensions and tolerances conform to ASME Y14.5M – 1994.
- Controlling dimension is in millimeters.
- Pin A1 may be indicated by an ID dot, or a special feature, in its proximity on package surface.

| Package Information        |   |
|----------------------------|---|
| Description                | Specification   |
| Ordering Code Reference    | F   |
| Package Acronym            | FBGA  |
| Substrate Material         | BT  |
| Solder Ball Composition    | Regular: 63Sn:37Pb (Typ.)<br>Pb-free: Sn:3Ag:0.5Cu (Typ.) |
| JEDEC Outline Reference    | MS-034 Variation: AAJ-1                                   |
| Lead Coplanarity           | 0.008 inches (0.20 mm)                                    |
| Weight                     | 2.3 g (Typ.)  |
| Moisture Sensitivity Level | Printed on moisture barrier bag                           |

| Package Outline Dimension Table |             |      |      |
|---------------------------------|-------------|------|------|
| Symbol                          | Millimeters |      |      |
|                                 | Min.        | Nom. | Max. |
| A                               | 2.10        | 2.25 | 2.40 |
| A1                              | 0.40        | 0.50 | 0.60 |
| A2                              | 1.50        | 1.75 | 2.00 |
| A3                              | 1.12        | 1.17 | 1.22 |
| D                               | 23.00 BSC   |      |      |
| E                               | 23.00 BSC   |      |      |
| b                               | 0.50        | 0.60 | 0.70 |
| e                               | 1.00 BSC    |      |      |

**Package Outline**



## 484-Pin Hybrid FineLine Ball-Grid Array (HBGA)—Flip Chip

- All dimensions and tolerances conform to ASME Y14.5M - 1994.
- Controlling dimension is in millimeters.
- Pin A1 may be indicated by an ID dot, or a special feature, in its proximity on package surface.

| Package Information        |   |
|----------------------------|---|
| Description                | Specification   |
| Ordering Code Reference    | H   |
| Package Acronym            | HBGA  |
| Substrate Material         | BT  |
| Solder Ball Composition    | Regular: 63Sn:37Pb (Typ.)<br>Pb-free: Sn:3Ag:0.5Cu (Typ.) |
| JEDEC Outline Reference    | MS-034 Variation: AAL-1                                   |
| Lead Coplanarity           | 0.008 inches (0.20mm)                                     |
| Weight                     | 11.3 g (Typ.)   |
| Moisture Sensitivity Level | Printed on moisture barrier bag                           |

| Package Outline Dimension Table |             |      |      |
|---------------------------------|-------------|------|------|
| Symbol                          | Millimeters |      |      |
|                                 | Min.        | Nom. | Max. |
| A                               | —           | —    | 3.50 |
| A1                              | 0.30        | —    | —    |
| A2                              | 0.25        | —    | 3.00 |
| A3                              | —           | —    | 2.50 |
| D                               | 27.00 BSC   |      |      |
| E                               | 27.00 BSC   |      |      |
| b                               | 0.50        | 0.60 | 0.70 |
| e                               | 1.00 BSC    |      |      |

**Package Outline**

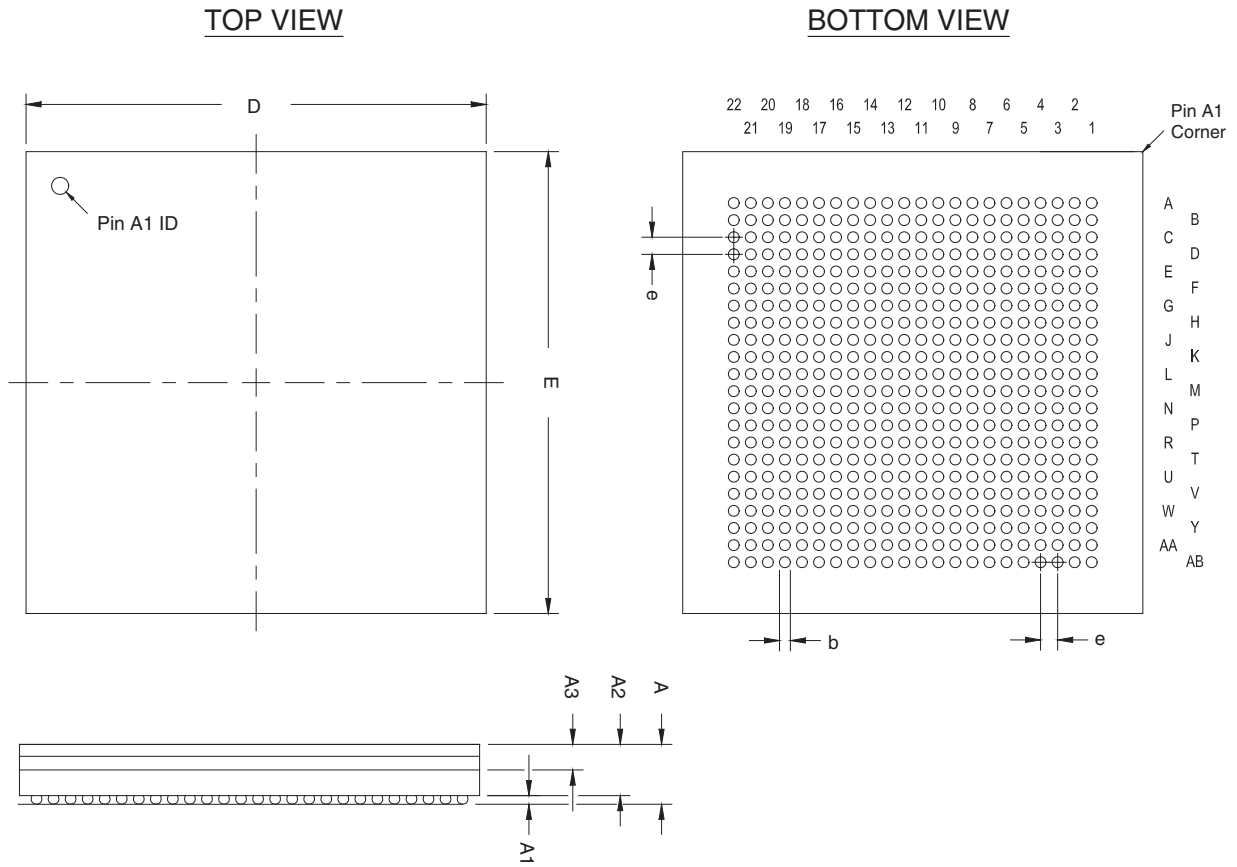

## 484-Pin Ultra FineLine Ball-Grid Array (UBGA)—Wire Bond

- All dimensions and tolerances conform to ASME Y14.5M - 1994.
- Controlling dimension is in millimeters.
- Pin A1 may be indicated by an ID dot, or a special feature, in its proximity on package surface.

| Package Information        |   |
|----------------------------|---|
| Description                | Specification   |
| Ordering Code Reference    | U   |
| Package Acronym            | UBGA  |
| Substrate Material         | BT  |
| Solder Ball Composition    | Regular: 63Sn:37Pb (Typ.)<br>Pb-free: Sn:3Ag:0.5Cu (Typ.) |
| JEDEC Outline Reference    | MO-216 Variation: BAP-2                                   |
| Lead Coplanarity           | 0.005 inches (0.12mm)                                     |
| Weight                     | 1.6 g (Typ.)  |
| Moisture Sensitivity Level | Printed on moisture barrier bag                           |

| Package Outline Dimension Table |             |      |      |
|---------------------------------|-------------|------|------|
| Symbol                          | Millimeters |      |      |
|                                 | Min.        | Nom. | Max. |
| A                               | —           | —    | 2.20 |
| A1                              | 0.20        | —    | —    |
| A2                              | 0.65        | —    | —    |
| A3                              | 0.95 TYP    |      |      |
| D                               | 19.00 BSC   |      |      |
| E                               | 19.00 BSC   |      |      |
| b                               | 0.40        | 0.50 | 0.60 |
| e                               | 0.80 BSC    |      |      |

**Package Outline**



## 503-Pin Ceramic Pin-Grid Array (PGA)—Wire Bond

- All dimensions and tolerances conform to ASME Y14.5M - 1994.
- Controlling dimension is in inches.
- Pin A1 may be indicated by an ID dot, or a special feature, in its proximity on package surface.

| Package Information        |                                 |
|----------------------------|---------------------------------|
| Description                | Specification                   |
| Ordering Code Reference    | G                               |
| Package Acronym            | PGA                             |
| Leadframe Material         | Alloy 42                        |
| Lead Finish                | Gold Over Nickel Plate          |
| JEDEC Outline Reference    | MO-128 Variation: AN            |
| Lead Coplanarity           | N/A                             |
| Weight                     | 59.0 g (Typ.)                   |
| Moisture Sensitivity Level | Printed on moisture barrier bag |

| Package Outline Dimension Table |           |       |       |
|---------------------------------|-----------|-------|-------|
| Symbol                          | Inches    |       |       |
|                                 | Min.      | Nom.  | Max.  |
| A                               | —         | —     | 0.205 |
| A1                              | 0.050 TYP |       |       |
| A2                              | —         | —     | 0.145 |
| D                               | 2.245     | 2.260 | 2.275 |
| E                               | 2.245     | 2.260 | 2.275 |
| L                               | 0.130 TYP |       |       |
| b                               | 0.016     | 0.018 | 0.020 |
| e                               | 0.100 BSC |       |       |

**Package Outline**



## 599-Pin Ceramic Pin-Grid Array (PGA)—Wire Bond

- All dimensions and tolerances conform to ASME Y14.5M – 1994.
- Controlling dimension is in inches.
- Pin A1 may be indicated by an ID dot, or a special feature, in its proximity on package surface.

| Package Information        |                                 |
|----------------------------|---------------------------------|
| Description                | Specification                   |
| Ordering Code Reference    | G                               |
| Package Acronym            | PGA                             |
| Leadframe Material         | Alloy 42                        |
| Lead Finish                | Gold over Nickel Plate          |
| JEDEC Outline Reference    | MO-128 Variation: AP            |
| Lead Coplanarity           | N/A                             |
| Weight                     | 69.0 g (Typ.)                   |
| Moisture Sensitivity Level | Printed on moisture barrier bag |

| Package Outline Dimension Table |           |       |       |
|---------------------------------|-----------|-------|-------|
| Symbol                          | Inches    |       |       |
|                                 | Min.      | Nom.  | Max.  |
| A                               | —         | —     | 0.205 |
| A1                              | 0.050 TYP |       |       |
| A2                              | —         | —     | 0.145 |
| D                               | 2.445     | 2.460 | 2.475 |
| E                               | 2.445     | 2.460 | 2.475 |
| L                               | 0.130 TYP |       |       |
| b                               | 0.016     | 0.018 | 0.020 |
| e                               | 0.100 BSC |       |       |

**Package Outline**

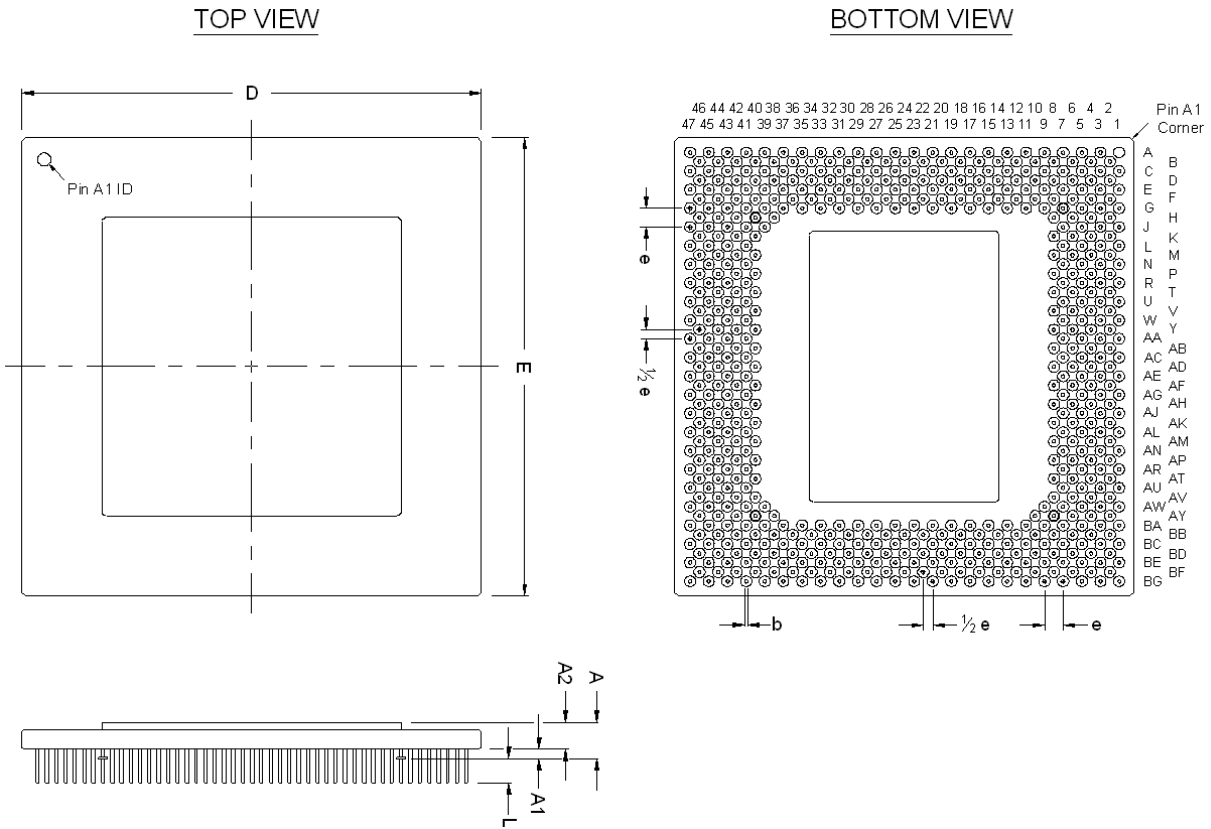

## 600-Pin Ball-Grid Array (BGA)—Wire Bond

- All dimensions and tolerances conform to ASME Y14.5M - 1994.
- Controlling dimension is in millimeters.
- Pin A1 may be indicated by an ID dot, or a special feature, in its proximity on package surface.

| Package Information        |   |
|----------------------------|---|
| Description                | Specification   |
| Ordering Code Reference    | B   |
| Package Acronym            | BGA   |
| Substrate Material         | BT or tape  |
| Solder Ball Composition    | Regular: 63Sn:37Pb (Typ.)<br>Pb-free: Sn:3Ag:0.5Cu (Typ.) |
| JEDEC Outline Reference    | MO-192 Variation: BAW-1                                   |
| Lead Coplanarity           | 0.008 inches (0.20mm)                                     |
| Weight                     | 12.0 g (Typ.)   |
| Moisture Sensitivity Level | Printed on moisture barrier bag                           |

| Package Outline Dimension Table |             |      |      |
|---------------------------------|-------------|------|------|
| Symbol                          | Millimeters |      |      |
|                                 | Min.        | Nom. | Max. |
| A                               | —           | —    | 2.00 |
| A1                              | 0.35        | —    | —    |
| A2                              | 0.25        | —    | 1.10 |
| D                               | 45.00 BSC   |      |      |
| E                               | 45.00 BSC   |      |      |
| b                               | 0.60        | 0.75 | 0.90 |
| e                               | 1.27 BSC    |      |      |

### Package Outline



## 652-Pin Ball-Grid Array (BGA), Option 1—Flip Chip

- All dimensions and tolerances conform to ASME Y14.5M - 1994.
- Controlling dimension is in millimeters.
- Pin A1 may be indicated by an ID dot, or a special feature, in its proximity on package surface.

| Package Information        |   |
|----------------------------|---|
| Description                | Specification   |
| Ordering Code Reference    | B   |
| Package Acronym            | BGA   |
| Substrate Material         | BT  |
| Solder Ball Composition    | Regular: 63Sn:37Pb (Typ.)<br>Pb-free: Sn:3Ag:0.5Cu (Typ.) |
| JEDEC Outline Reference    | MS-034 Variation: BAW-1                                   |
| Lead Coplanarity           | 0.008 inches (0.20 mm)                                    |
| Weight                     | 23.8 g (Typ.)   |
| Moisture Sensitivity Level | Printed on moisture barrier bag                           |

| Package Outline Dimension Table |             |      |      |
|---------------------------------|-------------|------|------|
| Symbol                          | Millimeters |      |      |
|                                 | Min.        | Nom. | Max. |
| A                               | —           | —    | 3.50 |
| A1                              | 0.30        | —    | —    |
| A2                              | 0.25        | —    | 3.00 |
| A3                              | —           | —    | 2.50 |
| D                               | 45.00 BSC   |      |      |
| E                               | 45.00 BSC   |      |      |
| b                               | 0.60        | 0.75 | 0.90 |
| e                               | 1.27 BSC    |      |      |

**Package Outline**



## 652-Pin Plastic Ball-Grid Array (BGA), Option 2—Wire Bond

- All dimensions and tolerances conform to ASME Y14.5M - 1994.
- Controlling dimension is in millimeters.
- Pin A1 may be indicated by an ID dot, or a special feature, in its proximity on package surface.

| Package Information        |   |
|----------------------------|---|
| Description                | Specification   |
| Ordering Code Reference    | B   |
| Package Acronym            | BGA   |
| Substrate Material         | BT  |
| Solder Ball Composition    | Regular: 63Sn:37Pb (Typ.)<br>Pb-free: Sn:3Ag:0.5Cu (Typ.) |
| JEDEC Outline Reference    | MS-034 Variation: BAW-1                                   |
| Lead Coplanarity           | 0.008 inches (0.20 mm)                                    |
| Weight                     | 15.9 g (Typ.)   |
| Moisture Sensitivity Level | Printed on moisture barrier bag                           |

| Package Outline Dimension Table |             |      |      |
|---------------------------------|-------------|------|------|
| Symbol                          | Millimeters |      |      |
|                                 | Min.        | Nom. | Max. |
| A                               | —           | —    | 3.20 |
| A1                              | 0.35        | —    | —    |
| A2                              | —           | —    | 2.80 |
| A3                              | —           | —    | 2.40 |
| D                               | 45.00 BSC   |      |      |
| E                               | 45.00 BSC   |      |      |
| b                               | 0.60        | 0.75 | 0.90 |
| e                               | 1.27 BSC    |      |      |

### Package Outline



## 652-Pin Plastic Ball-Grid Array (BGA), Option 3—Wire Bond

- All dimensions and tolerances conform to ASME Y14.5M - 1994.
- Controlling dimension is in millimeters.
- Pin A1 may be indicated by an ID dot, or a special feature, in its proximity on package surface.

| Package Information        |   |
|----------------------------|---|
| Description                | Specification   |
| Ordering Code Reference    | B   |
| Package Acronym            | BGA   |
| Substrate Material         | BT or tape  |
| Solder Ball Composition    | Regular: 63Sn:37Pb (Typ.)<br>Pb-free: Sn:3Ag:0.5Cu (Typ.) |
| JEDEC Outline Reference    | MO-192 Variation: BAW-1                                   |
| Lead Coplanarity           | 0.008 inches (0.20 mm)                                    |
| Weight                     | 15.1 g (Typ.)   |
| Moisture Sensitivity Level | Printed on moisture barrier bag                           |

| Package Outline Dimension Table |             |      |      |
|---------------------------------|-------------|------|------|
| Symbol                          | Millimeters |      |      |
|                                 | Min.        | Nom. | Max. |
| A                               | —           | —    | 2.00 |
| A1                              | 0.35        | —    | —    |
| A2                              | 0.25        | —    | 1.10 |
| D                               | 45.00 BSC   |      |      |
| E                               | 45.00 BSC   |      |      |
| b                               | 0.60        | 0.75 | 0.90 |
| e                               | 1.27 BSC    |      |      |

**Package Outline**



## 655-Pin Ceramic Pin-Grid Array (PGA)—Wire Bond

- All dimensions and tolerances conform to ASME Y14.5M – 1994.
- Controlling dimension is in inches.
- Pin A1 may be indicated by an ID dot, or a special feature, in its proximity on package surface.

| Package Information        |                                 |
|----------------------------|---------------------------------|
| Description                | Specification                   |
| Ordering Code Reference    | G                               |
| Package Acronym            | PGA                             |
| Leadframe Material         | Alloy 42                        |
| Lead Finish                | Gold over Nickel Plate          |
| JEDEC Outline Reference    | MO-128 Variation: AP            |
| Lead Coplanarity           | N/A                             |
| Weight                     | 74.9 g (Typ.)                   |
| Moisture Sensitivity Level | Printed on moisture barrier bag |

| Package Outline Dimension Table |           |       |       |
|---------------------------------|-----------|-------|-------|
| Symbol                          | Inches    |       |       |
|                                 | Min.      | Nom.  | Max.  |
| A                               | —         | —     | 0.205 |
| A1                              | 0.050 TYP |       |       |
| A2                              | —         | —     | 0.145 |
| D                               | 2.445     | 2.460 | 2.475 |
| E                               | 2.445     | 2.460 | 2.475 |
| L                               | 0.130 TYP |       |       |
| b                               | 0.016     | 0.018 | 0.020 |
| e                               | 0.100 BSC |       |       |

**Package Outline**



## 672-Pin Plastic Ball-Grid Array (BGA)—Wire Bond

- All dimensions and tolerances conform to ASME Y14.5M - 1994.
- Controlling dimension is in millimeters.
- Pin A1 may be indicated by an ID dot, or a special feature, in its proximity on package surface.

| Package Information        |   |
|----------------------------|---|
| Description                | Specification   |
| Ordering Code Reference    | B   |
| Package Acronym            | BGA   |
| Substrate Material         | BT  |
| Solder Ball Composition    | Regular: 63Sn:37Pb (Typ.)<br>Pb-free: Sn:3Ag:0.5Cu (Typ.) |
| JEDEC Outline Reference    | MS-034 Variation: BAR-2                                   |
| Lead Coplanarity           | 0.008 inches (0.20 mm)                                    |
| Weight                     | 5.8 g (Typ.)  |
| Moisture Sensitivity Level | Printed on moisture barrier bag                           |

| Package Outline Dimension Table |             |      |      |
|---------------------------------|-------------|------|------|
| Symbol                          | Millimeters |      |      |
|                                 | Min.        | Nom. | Max. |
| A                               | —           | —    | 2.60 |
| A1                              | 0.35        | —    | —    |
| A2                              | —           | —    | 2.20 |
| A3                              | —           | —    | 1.80 |
| D                               | 35.00 BSC   |      |      |
| E                               | 35.00 BSC   |      |      |
| b                               | 0.60        | 0.75 | 0.90 |
| e                               | 1.27 BSC    |      |      |

### Package Outline



## 672-Pin FineLine Ball-Grid Array (FBGA), Option 1—Flip Chip

- All dimensions and tolerances conform to ASME Y14.5M - 1994.
- Controlling dimension is in millimeters.
- Pin A1 may be indicated by an ID dot, or a special feature, in its proximity on package surface.

| Package Information        |   |
|----------------------------|---|
| Description                | Specification   |
| Ordering Code Reference    | F   |
| Package Acronym            | FBGA  |
| Substrate Material         | BT  |
| Solder Ball Composition    | Regular: 63Sn:37Pb (Typ.)<br>Pb-free: Sn:3Ag:0.5Cu (Typ.) |
| JEDEC Outline Reference    | MS-034 Variation: AAL-1                                   |
| Lead Coplanarity           | 0.008 inches (0.20 mm)                                    |
| Weight                     | 9.5 g (Typ.)  |
| Moisture Sensitivity Level | Printed on moisture barrier bag                           |

| Package Outline Dimension Table |             |      |      |
|---------------------------------|-------------|------|------|
| Symbol                          | Millimeters |      |      |
|                                 | Min.        | Nom. | Max. |
| A                               | —           | —    | 3.50 |
| A1                              | 0.30        | —    | —    |
| A2                              | 0.25        | —    | 3.00 |
| A3                              | —           | —    | 2.50 |
| D                               | 27.00 BSC   |      |      |
| E                               | 27.00 BSC   |      |      |
| b                               | 0.50        | 0.60 | 0.70 |
| e                               | 1.00 BSC    |      |      |

**Package Outline**



## 672-Pin FineLine Ball-Grid Array (FBGA), Option 2—Wire Bond

- All dimensions and tolerances conform to ASME Y14.5M - 1994.
- Controlling dimension is in millimeters.
- Pin A1 may be indicated by an ID dot, or a special feature, in its proximity on package surface.

| Package Information        |   |
|----------------------------|---|
| Description                | Specification   |
| Ordering Code Reference    | F   |
| Package Acronym            | FBGA  |
| Substrate Material         | BT  |
| Solder Ball Composition    | Regular: 63Sn:37Pb (Typ.)<br>Pb-free: Sn:3Ag:0.5Cu (Typ.) |
| JEDEC Outline Reference    | MS-034 Variation: AAL-1                                   |
| Lead Coplanarity           | 0.008 inches (0.20 mm)                                    |
| Weight                     | 3.8 g (Typ.)  |
| Moisture Sensitivity Level | Printed on moisture barrier bag                           |

| Package Outline Dimension Table |             |      |      |
|---------------------------------|-------------|------|------|
| Symbol                          | Millimeters |      |      |
|                                 | Min.        | Nom. | Max. |
| A                               | —           | —    | 2.60 |
| A1                              | 0.30        | —    | —    |
| A2                              | —           | —    | 2.20 |
| A3                              | —           | —    | 1.80 |
| D                               | 27.00 BSC   |      |      |
| E                               | 27.00 BSC   |      |      |
| b                               | 0.50        | 0.60 | 0.70 |
| e                               | 1.00 BSC    |      |      |

### Package Outline



## 672-Pin FineLine Ball-Grid Array (FBGA), Option 4—Flip Chip

- All dimensions and tolerances conform to ASME Y14.5M - 1994.
- Controlling dimension is in millimeters.
- Pin A1 may be indicated by an ID dot, or a special feature, in its proximity on package surface.

| Package Information        |   |
|----------------------------|---|
| Description                | Specification   |
| Ordering Code Reference    | F   |
| Package Acronym            | FBGA  |
| Substrate Material         | BT  |
| Solder Ball Composition    | Regular: 63Sn:37Pb (Typ.)<br>Pb-free: Sn:3Ag:0.5Cu (Typ.) |
| JEDEC Outline Reference    | MS-034 Variation: AAL-1                                   |
| Lead Coplanarity           | 0.008 inches (0.20 mm)                                    |
| Weight                     | 7.1 g (Typ.)  |
| Moisture Sensitivity Level | Printed on moisture barrier bag                           |

| Package Outline Dimension Table |             |      |      |
|---------------------------------|-------------|------|------|
| Symbol                          | Millimeters |      |      |
|                                 | Min.        | Nom. | Max. |
| A                               | —           | —    | 3.50 |
| A1                              | 0.30        | —    | —    |
| A2                              | 0.25        | —    | 3.00 |
| A3                              | —           | —    | 2.50 |
| D                               | 27.00 BSC   |      |      |
| D1                              | 20.00 BSC   |      |      |
| E                               | 27.00 BSC   |      |      |
| E1                              | 20.00 BSC   |      |      |
| b                               | 0.50        | 0.60 | 0.70 |
| e                               | 1.00 BSC    |      |      |

**Package Outline**



## 672-Pin FineLine Ball-Grid Array (FBGA)—Wire Bond—A:2.40

- All dimensions and tolerances conform to ASME Y14.5M - 1994.
- Controlling dimension is in millimeters.
- Pin A1 may be indicated by an ID dot, or a special feature, in its proximity on package surface.

| Package Information        |   |
|----------------------------|---|
| Description                | Specification   |
| Ordering Code Reference    | F   |
| Package Acronym            | FBGA  |
| Substrate Material         | BT  |
| Solder Ball Composition    | Regular: 63Sn:37Pb (Typ.)<br>Pb-free: Sn:3Ag:0.5Cu (Typ.) |
| JEDEC Outline Reference    | MS-034 Variation: AAL-1                                   |
| Lead Coplanarity           | 0.008 inches (0.20 mm)                                    |
| Weight                     | 3.0 g (Typ.)  |
| Moisture Sensitivity Level | Printed on moisture barrier bag                           |

| Package Outline Dimension Table |             |      |      |
|---------------------------------|-------------|------|------|
| Symbol                          | Millimeters |      |      |
|                                 | Min.        | Nom. | Max. |
| A                               | 2.10        | 2.25 | 2.40 |
| A1                              | 0.40        | 0.50 | 0.60 |
| A2                              | 1.50        | 1.75 | 2.00 |
| A3                              | 1.12        | 1.17 | 1.22 |
| D                               | 27.00 BSC   |      |      |
| E                               | 27.00 BSC   |      |      |
| b                               | 0.50        | 0.60 | 0.70 |
| e                               | 1.00 BSC    |      |      |

**Package Outline**



## 724-Pin Ball-Grid Array (BGA)—Flip Chip

- All dimensions and tolerances conform to ASME Y14.5M - 1994.
- Controlling dimension is in millimeters.
- Pin A1 may be indicated by an ID dot, or a special feature, in its proximity on package surface.

| Package Information        |   |
|----------------------------|---|
| Description                | Specification   |
| Ordering Code Reference    | B   |
| Package Acronym            | BGA   |
| Substrate Material         | BT  |
| Solder Ball Composition    | Regular: 63Sn:37Pb (Typ.)<br>Pb-free: Sn:3Ag:0.5Cu (Typ.) |
| JEDEC Outline Reference    | MS-034 Variation: BAR-1                                   |
| Lead Coplanarity           | 0.008 inches (0.20 mm)                                    |
| Weight                     | 13.6 g (Typ.)   |
| Moisture Sensitivity Level | Printed on moisture barrier bag                           |

| Package Outline Dimension Table |             |      |      |
|---------------------------------|-------------|------|------|
| Symbol                          | Millimeters |      |      |
|                                 | Min.        | Nom. | Max. |
| A                               | —           | —    | 3.50 |
| A1                              | 0.30        | —    | —    |
| A2                              | 0.25        | —    | 3.00 |
| A3                              | —           | —    | 2.50 |
| D                               | 35.00 BSC   |      |      |
| E                               | 35.00 BSC   |      |      |
| b                               | 0.60        | 0.75 | 0.90 |
| e                               | 1.27 BSC    |      |      |

**Package Outline**

TOP VIEW

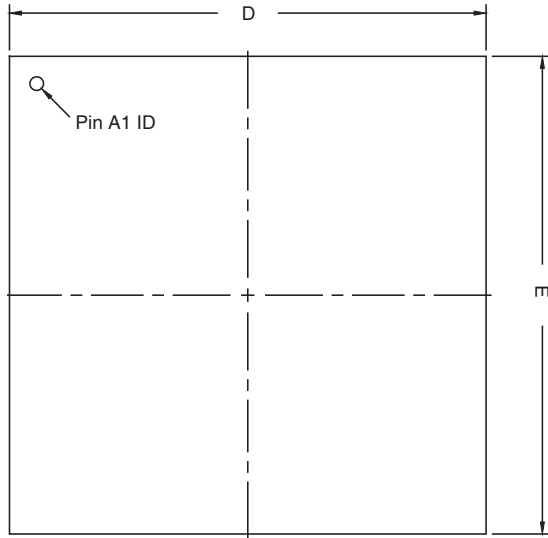

BOTTOM VIEW

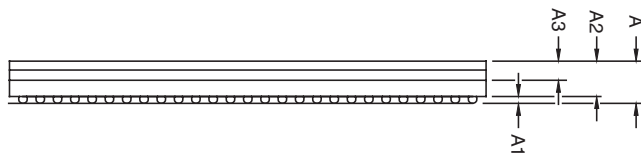
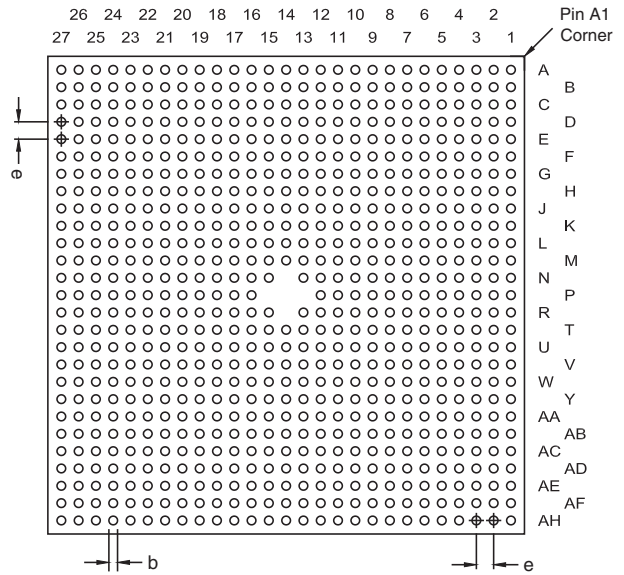

## 780-Pin FineLine Ball-Grid Array (FBGA), Option 1—Flip Chip

- All dimensions and tolerances conform to ASME Y14.5M - 1994.
- Controlling dimension is in millimeters.
- Pin A1 may be indicated by an ID dot, or a special feature, in its proximity on package surface.

| Package Information        |   |
|----------------------------|---|
| Description                | Specification   |
| Ordering Code Reference    | F   |
| Package Acronym            | FBGA  |
| Substrate Material         | BT  |
| Solder Ball Composition    | Regular: 63Sn:37Pb (Typ.)<br>Pb-free: Sn:3Ag:0.5Cu (Typ.) |
| JEDEC Outline Reference    | MS-034 Variation: AAM-1                                   |
| Lead Coplanarity           | 0.008 inches (0.20 mm)                                    |
| Weight                     | 10.7 g (Typ.)   |
| Moisture Sensitivity Level | Printed on moisture barrier bag                           |

| Package Outline Dimension Table |             |      |      |
|---------------------------------|-------------|------|------|
| Symbol                          | Millimeters |      |      |
|                                 | Min.        | Nom. | Max. |
| A                               | —           | —    | 3.50 |
| A1                              | 0.30        | —    | —    |
| A2                              | 0.25        | —    | 3.00 |
| A3                              | —           | —    | 2.50 |
| D                               | 29.00 BSC   |      |      |
| E                               | 29.00 BSC   |      |      |
| b                               | 0.50        | 0.60 | 0.70 |
| e                               | 1.00 BSC    |      |      |

**Package Outline**



## 780-Pin FineLine Ball-Grid Array (FBGA), Option 1—Flip Chip—Channel Lid

- All dimensions and tolerances conform to ASME Y14.5M - 1994.
- Controlling dimension is in millimeters.
- Pin A1 may be indicated by an ID dot, or a special feature, in its proximity on package surface.

| Package Information        |   |
|----------------------------|---|
| Description                | Specification   |
| Ordering Code Reference    | F   |
| Package Acronym            | FBGA  |
| Substrate Material         | BT  |
| Solder Ball Composition    | Regular: 63Sn:37Pb (Typ.)<br>Pb-free: Sn:3Ag:0.5Cu (Typ.) |
| JEDEC Outline Reference    | MO-034 Variation: AAM-1                                   |
| Lead Coplanarity           | 0.008 inches (0.20 mm)                                    |
| Weight                     | 9.5 g (Typ.)  |
| Moisture Sensitivity Level | Printed on moisture barrier bag                           |

| Package Outline Dimension Table |             |      |      |
|---------------------------------|-------------|------|------|
| Symbol                          | Millimeters |      |      |
|                                 | Min.        | Nom. | Max. |
| A                               | 3.05        | 3.25 | 3.45 |
| A1                              | 0.40        | 0.50 | 0.60 |
| A2                              | 2.45        | 2.75 | 3.05 |
| A3                              | 1.45        | 1.55 | 1.65 |
| D                               | 29.00 BSC   |      |      |
| E                               | 29.00 BSC   |      |      |
| b                               | 0.50        | 0.60 | 0.70 |
| e                               | 1.00 BSC    |      |      |

**Package Outline**



## 780-Pin FineLine Ball-Grid Array (FBGA), Option 3—Flip Chip

- All dimensions and tolerances conform to ASME Y14.5M - 1994.
- Controlling dimension is in millimeters.
- Pin A1 may be indicated by an ID dot, or a special feature, in its proximity on package surface.

| Package Information        |   |
|----------------------------|---|
| Description                | Specification   |
| Ordering Code Reference    | F   |
| Package Acronym            | FBGA  |
| Substrate Material         | BT  |
| Solder Ball Composition    | Regular: 63Sn:37Pb (Typ.)<br>Pb-free: Sn:3Ag:0.5Cu (Typ.) |
| JEDEC Outline Reference    | MS-034 Variation: AAM-1                                   |
| Lead Coplanarity           | 0.008 inches (0.20 mm)                                    |
| Weight                     | 8.2 g (Typ.)  |
| Moisture Sensitivity Level | Printed on moisture barrier bag                           |

| Package Outline Dimension Table |             |      |      |
|---------------------------------|-------------|------|------|
| Symbol                          | Millimeters |      |      |
|                                 | Min.        | Nom. | Max. |
| A                               | —           | —    | 3.50 |
| A1                              | 0.30        | —    | —    |
| A2                              | 0.25        | —    | 3.00 |
| A3                              | —           | —    | 2.50 |
| D                               | 29.00 BSC   |      |      |
| D1                              | 21.00 BSC   |      |      |
| E                               | 29.00 BSC   |      |      |
| E1                              | 21.00 BSC   |      |      |
| b                               | 0.50        | 0.60 | 0.70 |
| e                               | 1.00 BSC    |      |      |

**Package Outline**

TOP VIEW

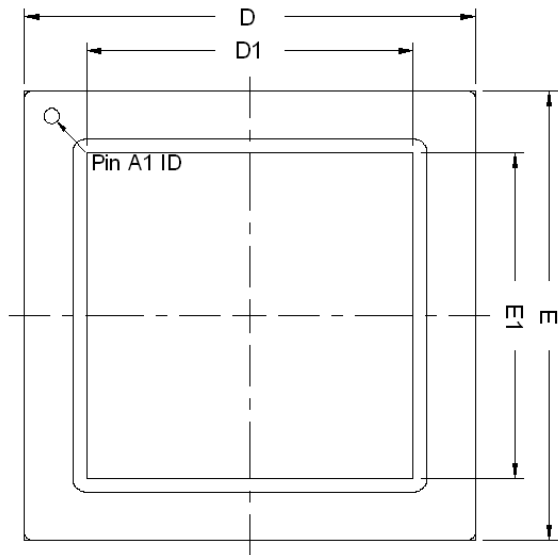

BOTTOM VIEW

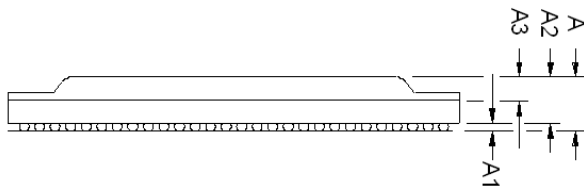
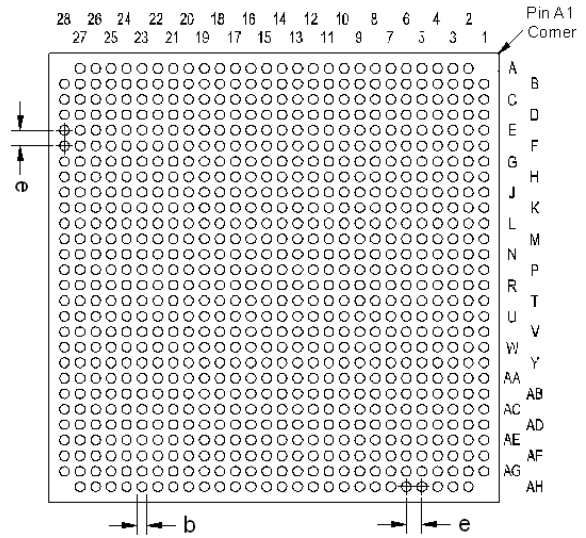

## 896-Pin FineLine Ball-Grid Array (FBGA)—Wire Bond—A:2.40

- All dimensions and tolerances conform to ASME Y14.5M – 1994.
- Controlling dimension is in millimeters.
- Pin A1 may be indicated by an ID dot, or a special feature, in its proximity on package surface.

| Package Information        |   |
|----------------------------|---|
| Description                | Specification   |
| Ordering Code Reference    | F   |
| Package Acronym            | FBGA  |
| Substrate Material         | BT  |
| Solder Ball Composition    | Regular: 63Sn:37Pb (Typ.)<br>Pb-free: Sn:3Ag:0.5Cu (Typ.) |
| JEDEC Outline Reference    | MS-034 Variation: AAN-1                                   |
| Lead Coplanarity           | 0.008 inches (0.20 mm)                                    |
| Weight                     | 3.9 g (Typ.)  |
| Moisture Sensitivity Level | Printed on moisture barrier bag                           |

| Package Outline Dimension Table |             |      |      |
|---------------------------------|-------------|------|------|
| Symbol                          | Millimeters |      |      |
|                                 | Min.        | Nom. | Max. |
| A                               | 2.10        | 2.25 | 2.40 |
| A1                              | 0.40        | 0.50 | 0.60 |
| A2                              | 1.50        | 1.75 | 2.00 |
| A3                              | 1.12        | 1.17 | 1.22 |
| D                               | 31.00 BSC   |      |      |
| E                               | 31.00 BSC   |      |      |
| b                               | 0.50        | 0.60 | 0.70 |
| e                               | 1.00 BSC    |      |      |

**Package Outline**



## 956-Pin Ball-Grid Array (BGA), Option 1—Flip Chip

- All dimensions and tolerances conform to ASME Y14.5M - 1994.
- Controlling dimension is in millimeters.
- Pin A1 may be indicated by an ID dot, or a special feature, in its proximity on package surface.

| Package Information        |   |
|----------------------------|---|
| Description                | Specification   |
| Ordering Code Reference    | B   |
| Package Acronym            | BGA   |
| Substrate Material         | BT  |
| Solder Ball Composition    | Regular: 63Sn:37Pb (Typ.)<br>Pb-free: Sn:3Ag:0.5Cu (Typ.) |
| JEDEC Outline Reference    | MS-034 Variation: BAU-1                                   |
| Lead Coplanarity           | 0.008 inches (0.20 mm)                                    |
| Weight                     | 19.6 g (Typ.)   |
| Moisture Sensitivity Level | Printed on moisture barrier bag                           |

| Package Outline Dimension Table |             |      |      |
|---------------------------------|-------------|------|------|
| Symbol                          | Millimeters |      |      |
|                                 | Min.        | Nom. | Max. |
| A                               | —           | —    | 3.50 |
| A1                              | 0.30        | —    | —    |
| A2                              | 0.25        | —    | 3.00 |
| A3                              | —           | —    | 2.50 |
| D                               | 40.00 BSC   |      |      |
| E                               | 40.00 BSC   |      |      |
| b                               | 0.60        | 0.75 | 0.90 |
| e                               | 1.27 BSC    |      |      |

**Package Outline**



## 956-Pin Ball-Grid Array (BGA), Option 2—Flip Chip

- All dimensions and tolerances conform to ASME Y14.5M - 1994.
- Controlling dimension is in millimeters.
- Pin A1 may be indicated by an ID dot, or a special feature, in its proximity on package surface.

| Package Information        |   |
|----------------------------|---|
| Description                | Specification   |
| Ordering Code Reference    | B   |
| Package Acronym            | BGA   |
| Substrate Material         | BT  |
| Solder Ball Composition    | Regular: 63Sn:37Pb (Typ.)<br>Pb-free: Sn:3Ag:0.5Cu (Typ.) |
| JEDEC Outline Reference    | MS-034 Variation: BAU-1                                   |
| Lead Coplanarity           | 0.008 inches (0.20 mm)                                    |
| Weight                     | 17.0 g (Typ.)   |
| Moisture Sensitivity Level | Printed on moisture barrier bag                           |

| Package Outline Dimension Table |             |      |      |
|---------------------------------|-------------|------|------|
| Symbol                          | Millimeters |      |      |
|                                 | Min.        | Nom. | Max. |
| A                               | —           | —    | 3.50 |
| A1                              | 0.30        | —    | —    |
| A2                              | 0.25        | —    | 3.00 |
| A3                              | —           | —    | 2.50 |
| D                               | 40.00 BSC   |      |      |
| D1                              | 30.00 BSC   |      |      |
| E                               | 40.00 BSC   |      |      |
| E1                              | 30.00 BSC   |      |      |
| b                               | 0.60        | 0.75 | 0.90 |
| e                               | 1.27 BSC    |      |      |

**Package Outline**

TOP VIEW



BOTTOM VIEW

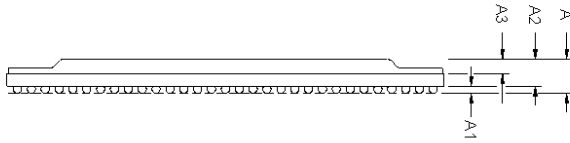

## 1020-Pin FineLine Ball-Grid Array (FBGA), Option 1—Flip Chip

- All dimensions and tolerances conform to ASME Y14.5M - 1994.
- Controlling dimension is in millimeters.
- Pin A1 may be indicated by an ID dot, or a special feature, in its proximity on package surface.

| Package Information        |   |
|----------------------------|---|
| Description                | Specification   |
| Ordering Code Reference    | F   |
| Package Acronym            | FBGA  |
| Substrate Material         | BT  |
| Solder Ball Composition    | Regular: 63Sn:37Pb (Typ.)<br>Pb-free: Sn:3Ag:0.5Cu (Typ.) |
| JEDEC Outline Reference    | MS-034 Variation: AAP-1                                   |
| Lead Coplanarity           | 0.008 inches (0.20 mm)                                    |
| Weight                     | 13.8 g (Typ.)   |
| Moisture Sensitivity Level | Printed on moisture barrier bag                           |

| Package Outline Dimension Table |             |      |      |
|---------------------------------|-------------|------|------|
| Symbol                          | Millimeters |      |      |
|                                 | Min.        | Nom. | Max. |
| A                               | —           | —    | 3.50 |
| A1                              | 0.30        | —    | —    |
| A2                              | 0.25        | —    | 3.00 |
| A3                              | —           | —    | 2.50 |
| D                               | 33.00 BSC   |      |      |
| E                               | 33.00 BSC   |      |      |
| b                               | 0.50        | 0.60 | 0.70 |
| e                               | 1.00 BSC    |      |      |

### Package Outline



## 1020-Pin FineLine Ball-Grid Array (FBGA), Option 2—Flip Chip

- All dimensions and tolerances conform to ASME Y14.5M - 1994.
- Controlling dimension is in millimeters.
- Pin A1 may be indicated by an ID dot, or a special feature, in its proximity on package surface.

| Package Information        |   |
|----------------------------|---|
| Description                | Specification   |
| Ordering Code Reference    | F   |
| Package Acronym            | FBGA  |
| Substrate Material         | BT  |
| Solder Ball Composition    | Regular: 63Sn:37Pb (Typ.)<br>Pb-free: Sn:3Ag:0.5Cu (Typ.) |
| JEDEC Outline Reference    | MS-034 Variation: AAP-1                                   |
| Lead Coplanarity           | 0.008 inches (0.20 mm)                                    |
| Weight                     | 10.8 g (Typ.)   |
| Moisture Sensitivity Level | Printed on moisture barrier bag                           |

| Package Outline Dimension Table |             |      |      |
|---------------------------------|-------------|------|------|
| Symbol                          | Millimeters |      |      |
|                                 | Min.        | Nom. | Max. |
| A                               | —           | —    | 3.50 |
| A1                              | 0.30        | —    | —    |
| A2                              | 0.25        | —    | 3.00 |
| A3                              | —           | —    | 2.50 |
| D                               | 33.00 BSC   |      |      |
| D1                              | 26.00 BSC   |      |      |
| E                               | 33.00 BSC   |      |      |
| E1                              | 26.00 BSC   |      |      |
| b                               | 0.50        | 0.60 | 0.70 |
| e                               | 1.00 BSC    |      |      |

**Package Outline**

TOP VIEW



BOTTOM VIEW



## 1152-Pin FineLine Ball-Grid Array (FBGA), Option 1—Flip Chip

- All dimensions and tolerances conform to ASME Y14.5M - 1994.
- Controlling dimension is in millimeters.
- Pin A1 may be indicated by an ID dot, or a special feature, in its proximity on package surface.

| Package Information        |   |
|----------------------------|---|
| Description                | Specification   |
| Ordering Code Reference    | F   |
| Package Acronym            | FBGA  |
| Substrate Material         | BT  |
| Solder Ball Composition    | Regular: 63Sn:37Pb (Typ.)<br>Pb-free: Sn:3Ag:0.5Cu (Typ.) |
| JEDEC Outline Reference    | MS-034 Variation: AAR-1                                   |
| Lead Coplanarity           | 0.008 inches (0.20 mm)                                    |
| Weight                     | 15.5 g (Typ.)   |
| Moisture Sensitivity Level | Printed on moisture barrier bag                           |

| Package Outline Dimension Table |             |      |      |
|---------------------------------|-------------|------|------|
| Symbol                          | Millimeters |      |      |
|                                 | Min.        | Nom. | Max. |
| A                               | —           | —    | 3.50 |
| A1                              | 0.30        | —    | —    |
| A2                              | 0.25        | —    | 3.00 |
| A3                              | —           | —    | 2.50 |
| D                               | 35.00 BSC   |      |      |
| E                               | 35.00 BSC   |      |      |
| b                               | 0.50        | 0.60 | 0.70 |
| e                               | 1.00 BSC    |      |      |

**Package Outline**

TOP VIEW



BOTTOM VIEW

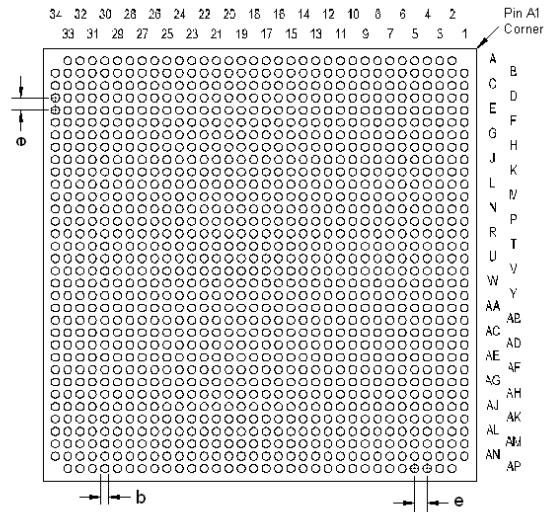

## 1152-Pin FineLine Ball-Grid Array (FBGA), Option 2—Flip Chip

- All dimensions and tolerances conform to ASME Y14.5M - 1994.
- Controlling dimension is in millimeters.
- Pin A1 may be indicated by an ID dot, or a special feature, in its proximity on package surface.

| Package Information        |   |
|----------------------------|---|
| Description                | Specification   |
| Ordering Code Reference    | F   |
| Package Acronym            | FBGA  |
| Substrate Material         | BT  |
| Solder Ball Composition    | Regular: 63Sn:37Pb (Typ.)<br>Pb-free: Sn:3Ag:0.5Cu (Typ.) |
| JEDEC Outline Reference    | MS-034 Variation: AAR-1                                   |
| Lead Coplanarity           | 0.008 inches (0.20 mm)                                    |
| Weight                     | 12.4 g (Typ.)   |
| Moisture Sensitivity Level | Printed on moisture barrier bag                           |

| Package Outline Dimension Table |             |      |      |
|---------------------------------|-------------|------|------|
| Symbol                          | Millimeters |      |      |
|                                 | Min.        | Nom. | Max. |
| A                               | —           | —    | 3.50 |
| A1                              | 0.30        | —    | —    |
| A2                              | 0.25        | —    | 3.00 |
| A3                              | —           | —    | 2.50 |
| D                               | 35.00 BSC   |      |      |
| D1                              | 27.00 BSC   |      |      |
| E                               | 35.00 BSC   |      |      |
| E1                              | 27.00 BSC   |      |      |
| b                               | 0.50        | 0.60 | 0.70 |
| e                               | 1.00 BSC    |      |      |

**Package Outline**

TOP VIEW



BOTTOM VIEW

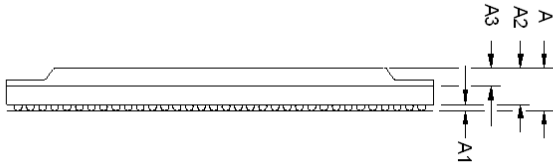

## 1508-Pin FineLine Ball-Grid Array (FBGA), Option 1—Flip Chip

- All dimensions and tolerances conform to ASME Y14.5M - 1994.
- Controlling dimension is in millimeters.
- Pin A1 may be indicated by an ID dot, or a special feature, in its proximity on package surface.

| Package Information        |   |
|----------------------------|---|
| Description                | Specification   |
| Ordering Code Reference    | F   |
| Package Acronym            | FBGA  |
| Substrate Material         | BT  |
| Solder Ball Composition    | Regular: 63Sn:37Pb (Typ.)<br>Pb-free: Sn:3Ag:0.5Cu (Typ.) |
| JEDEC Outline Reference    | MS-034 Variation: AAU-1                                   |
| Lead Coplanarity           | 0.008 inches (0.20 mm)                                    |
| Weight                     | 18.9 g (Typ.)   |
| Moisture Sensitivity Level | Printed on moisture barrier bag                           |

| Package Outline Dimension Table |             |      |      |
|---------------------------------|-------------|------|------|
| Symbol                          | Millimeters |      |      |
|                                 | Min.        | Nom. | Max. |
| A                               | —           | —    | 3.50 |
| A1                              | 0.30        | —    | —    |
| A2                              | 0.25        | —    | 3.00 |
| A3                              | —           | —    | 2.50 |
| D                               | 40.00 BSC   |      |      |
| E                               | 40.00 BSC   |      |      |
| b                               | 0.50        | 0.60 | 0.70 |
| e                               | 1.00 BSC    |      |      |

**Package Outline**



## 1508-Pin FineLine Ball-Grid Array (FBGA), Option 2—Flip Chip

- All dimensions and tolerances conform to ASME Y14.5M - 1994.
- Controlling dimension is in millimeters.
- Pin A1 may be indicated by an ID dot, or a special feature, in its proximity on package surface.

| Package Information        |   |
|----------------------------|---|
| Description                | Specification   |
| Ordering Code Reference    | F   |
| Package Acronym            | FBGA  |
| Substrate Material         | BT  |
| Solder Ball Composition    | Regular: 63Sn:37Pb (Typ.)<br>Pb-free: Sn:3Ag:0.5Cu (Typ.) |
| JEDEC Outline Reference    | MS-034 Variation: AAU-1                                   |
| Lead Coplanarity           | 0.008 inches (0.20 mm)                                    |
| Weight                     | 15.9 g (Typ.)   |
| Moisture Sensitivity Level | Printed on moisture barrier bag                           |

| Package Outline Dimension Table |             |      |      |
|---------------------------------|-------------|------|------|
| Symbol                          | Millimeters |      |      |
|                                 | Min.        | Nom. | Max. |
| A                               | —           | —    | 3.50 |
| A1                              | 0.30        | —    | —    |
| A2                              | 0.25        | —    | 3.00 |
| A3                              | —           | —    | 2.50 |
| D                               | 40.00 BSC   |      |      |
| D1                              | 30.00 BSC   |      |      |
| E                               | 40.00 BSC   |      |      |
| E1                              | 30.00 BSC   |      |      |
| b                               | 0.50        | 0.60 | 0.70 |
| e                               | 1.00 BSC    |      |      |

**Package Outline**

TOP VIEW

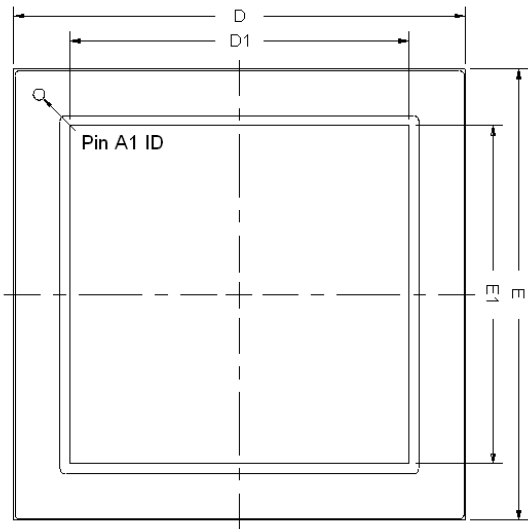

BOTTOM VIEW



## Additional Information

This section contains revision history and contact information.

### Revision History

Table 60 lists the revision history for this document.

**Table 60.** Document Revision History (1) (Part 1 of 13)

| Date and Document Version | Changes Made  | Summary of Changes       |
|---------------------------|---|--------------------------|
| December 2011             | <ul style="list-style-type: none"> <li>■ Added “896-Pin FineLine Ball-Grid Array (FBGA)—Wire Bond—A:2.40”, “484-Pin FineLine Ball-Grid Array (FBGA)—Wire Bond—A:2.40”, and “672-Pin FineLine Ball-Grid Array (FBGA)—Wire Bond—A:2.40”.</li> </ul> | Updated for version 16.8 |
| November 2011             | <ul style="list-style-type: none"> <li>■ Added Table 9 on page 10.</li> </ul>   | Updated for version 16.7 |
| August 2011               | <ul style="list-style-type: none"> <li>■ Removed HardCopy III, HardCopy IV, MAX V, MAX II, Classic, and EPCS devices’ package listing and thermal resistance values.</li> </ul>   | Updated for version 16.6 |
| July 2011                 | <ul style="list-style-type: none"> <li>■ Removed Arria II, Stratix V, Stratix IV, Stratix III, Cyclone IV, and Cyclone III devices’ package listing and thermal resistance values.</li> </ul>   | Updated for version 16.5 |

**Table 60.** Document Revision History (1) (Part 2 of 13)

| Date and Document Version | Changes Made  | Summary of Changes       |
|---------------------------|---|--------------------------|
| June 2011                 | <ul style="list-style-type: none"> <li>■ Updated package diagram in “780-Pin FineLine Ball-Grid Array (FBGA)—Flip Chip—Dual-Piece Lid (EP3SL150)” and “780-Pin FineLine Ball-Grid Array (FBGA)—Flip Chip—Dual-Piece Lid (EP3SE110)”</li> <li>■ Added Table 30 and Table 58.</li> <li>■ Updated the A and A2 dimension values in “780-Pin FineLine Ball-Grid Array (FBGA)—Flip Chip—Channel Lid (EP4SGX230)” and “780-Pin FineLine Ball-Grid Array (FBGA)—Flip Chip—Channel Lid (EP4SE230)”.</li> <li>■ Updated the D1 and E1 dimension values in “1152-Pin FineLine Ball-Grid Array (FBGA)—Flip Chip—Single-Piece Lid (EP4SGX290)” and “1152-Pin FineLine Ball-Grid Array (FBGA)—Flip Chip—Single-Piece Lid (EP4SGX360)”.</li> <li>■ Updated Table 13.</li> <li>■ Updated the b, A, and A2 dimension values in “256-Pin Ultra FineLine Ball-Grid Array (UBGA)—Wire Bond—Thin (EP3C10)”, “256-Pin Ultra FineLine Ball-Grid Array (UBGA)—Wire Bond—Thin (EP3C16)” and “256-Pin Ultra FineLine Ball-Grid Array (UBGA)—Wire Bond—Thin (EP3C25)”.</li> <li>■ Updated information in “Package Outlines”.</li> <li>■ Added new package diagram for “1152-Pin FineLine Ball-Grid Array (HBGA)—Flip Chip—Dual-Piece Lid (EP3SL340)”, and “780-Pin FineLine Ball-Grid Array (FBGA)—Flip Chip—Channel Lid (EP4SGX180)”.</li> <li>■ Added new 1760-pin packages for 5SGXB5 and 5SGXB6 devices: “1760-Pin FineLine Ball-Grid Array (FBGA)—Flip Chip—Single-Piece Lid—A:3.40” to replace the 1932-pin packages for 5SGXB5 and 5SGXB6 devices.</li> <li>■ Updated cross reference for 5SGXB5 and 5SGXB6 1517-pin package diagram in Table 3.</li> <li>■ Updated table Table 33.</li> </ul> | Updated for version 16.4 |

**Table 60.** Document Revision History (1) (Part 3 of 13)

| Date and Document Version | Changes Made   | Summary of Changes       |
|---------------------------|--|--------------------------|
| December 2010             | <ul style="list-style-type: none"> <li>■ Updated document title and metadata.</li> <li>■ Updated Table 43 with new thermal resistance value for EP3C16 (U484 Wire Bond package) and EP3C40 (U484 Wire Bond and F780 Wire Bond packages).</li> <li>■ Updated note 3 in Table 9.</li> <li>■ Updated Table 19 and Table 53 to remove dual-piece lid options for HardCopy II devices.</li> <li>■ Added Arria II GZ device package listing in Table 2 and Arria II GZ thermal resistance in Table 35.</li> <li>■ Added Stratix V device package listing in Table 4 and Stratix V thermal resistance in Table 37.</li> <li>■ Added MAX V device package listing in Table 13 and MAX V thermal resistance in Table 46.</li> <li>■ Added new Cyclone IV device package in Table 9 and thermal resistance values in Table 42.</li> <li>■ Updated lead coplanarity and A3 dimension values in 358-Pin Ultra FineLine Ball-Grid Array (UBGA)—Flip Chip, 358-Pin Ultra FineLine Ball-Grid Array (UBGA)—Flip Chip—Lidless (EP2AGX45), and 358-Pin Ultra FineLine Ball-Grid Array (UBGA)—Flip Chip—Lidless (EP2AGX65).</li> <li>■ Added new package diagram for 1932-Pin FineLine Ball-Grid Array (FBGA)—Flip Chip—Single-Piece Lid (EP4SGX360), 324-Pin FineLine Ball-Grid Array (FBGA)—Wire Bond (EPM2210), and 324-Pin FineLine Ball-Grid Array (FBGA)—Wire Bond (EPM2210G).</li> </ul> | Updated for version 16.3 |

**Table 60.** Document Revision History (1) (Part 4 of 13)

| Date and Document Version | Changes Made   | Summary of Changes       |
|---------------------------|--|--------------------------|
| September 2010            | <ul style="list-style-type: none"> <li data-bbox="423 306 1133 457">■ Updated JEDEC Outline Reference for “144-Pin Plastic Enhanced Quad Flat Pack (EQFP)—Wire Bond (EP3C10)”, “144-Pin Plastic Enhanced Quad Flat Pack (EQFP)—Wire Bond—(EP3C16)”, and “144-Pin Plastic Enhanced Quad Flat Pack (EQFP)—Wire Bond—(EP3C25)”.</li> <li data-bbox="423 470 1133 1014">■ Updated dimension value for Arria II GX devices: “572-Pin FineLine Ball-Grid Array (FBGA)—Lidless—Flip Chip (EP2AGX95)”, “780-Pin FineLine Ball-Grid Array (FBGA)—Flip Chip—Lidless (EP2AGX95)”, “1152-Pin FineLine Ball-Grid Array (FBGA)—Flip Chip—Lidless (EP2AGX95)”, “572-Pin FineLine Ball-Grid Array (FBGA)—Lidless—Flip Chip (EP2AGX65)”, “780-Pin FineLine Ball-Grid Array (FBGA)—Flip Chip—Lidless (EP2AGX65)”, “572-Pin FineLine Ball-Grid Array (FBGA)—Lidless—Flip Chip (EP2AGX45)”, “780-Pin FineLine Ball-Grid Array (FBGA)—Flip Chip—Lidless (EP2AGX45)”, “1152-Pin FineLine Ball-Grid Array (FBGA)—Flip Chip—Lidless (EP2AGX260)”, “780-Pin FineLine Ball-Grid Array (FBGA)—Flip Chip—Lidless (EP2AGX260)”, “1152-Pin FineLine Ball-Grid Array (FBGA)—Flip Chip—Lidless (EP2AGX190)”, “780-Pin FineLine Ball-Grid Array (FBGA)—Flip Chip—Lidless (EP2AGX190)”, “1152-Pin FineLine Ball-Grid Array (FBGA)—Flip Chip—Lidless (EP2AGX125)”, “780-Pin FineLine Ball-Grid Array (FBGA)—Flip Chip—Lidless (EP2AGX125)”, and “572-Pin FineLine Ball-Grid Array (FBGA)—Lidless—Flip Chip (EP2AGX125)”.</li> <li data-bbox="423 1026 1133 1482">■ Updated dimension value for HardCopy devices: “1517-Pin FineLine Ball-Grid Array (FBGA)—Flip Chip—Lidless (HC4E35)”, “1152-Pin FineLine Ball-Grid Array (FBGA)—Flip Chip—Lidless (HC4E35)”, “1517-Pin FineLine Ball-Grid Array (FBGA)—Flip Chip—Lidless (HC335)”, “1152-Pin FineLine Ball-Grid Array (FBGA)—Flip Chip—Lidless (HC335)”, “780-Pin FineLine Ball-Grid Array (FBGA)—Flip Chip—Lidless (HC325)”, “484-Pin FineLine Ball-Grid Array (FBGA)—Flip Chip—Lidless (HC4E25)”, “780-Pin FineLine Ball-Grid Array (FBGA)—Flip Chip—Lidless (HC4E25)”, “780-Pin FineLine Ball-Grid Array (FBGA)—Flip Chip—Lidless (HC4GX15)”, “780-Pin FineLine Ball-Grid Array (FBGA)—Flip Chip—Lidless (HC4GX25)”, “1152-Pin FineLine Ball-Grid Array (FBGA)—Flip Chip—Lidless (HC4GX25)”, “1152-Pin FineLine Ball-Grid Array (FBGA)—Flip Chip—Lidless (HC4GX35)”, and “1517-Pin FineLine Ball-Grid Array (FBGA)—Flip Chip—Lidless (HC4GX35)”.</li> <li data-bbox="423 1495 1133 1852">■ Revised the unit weight info for: “484-Pin FineLine Ball-Grid Array (FBGA), Option 1—Flip Chip”, “484-Pin FineLine Ball-Grid Array (FBGA), Option 4—Flip Chip”, “572-Pin FineLine Ball-Grid Array (FBGA)—Option 1, Flip Chip”, “572-Pin FineLine Ball-Grid Array (FBGA)—Option 2, Flip Chip”, “672-Pin FineLine Ball-Grid Array (FBGA), Option 1—Flip Chip”, “672-Pin FineLine Ball-Grid Array (FBGA), Option 4—Flip Chip”, “780-Pin FineLine Ball-Grid Array (FBGA), Option 1—Flip Chip”, “780-Pin FineLine Ball-Grid Array (FBGA), Option 3—Flip Chip”, “780-Pin FineLine Ball-Grid Array (FBGA), Option 4—Flip Chip”“1020-Pin FineLine Ball-Grid Array (FBGA), Option 1—Flip Chip”, and “1020-Pin FineLine Ball-Grid Array (FBGA), Option 2—Flip Chip”.</li> </ul> | Updated for version 16.2 |

**Table 60.** Document Revision History (1) (Part 5 of 13)

| Date and Document Version | Changes Made   | Summary of Changes |
|---------------------------|--|--------------------|
|                           | <ul style="list-style-type: none"> <li data-bbox="420 306 1133 911">■ Revised the unit weight info for: “1152-Pin FineLine Ball-Grid Array (FBGA), Option 1—Flip Chip”, “1152-Pin FineLine Ball-Grid Array (FBGA), Option 2—Flip Chip”, “1152-Pin FineLine Ball-Grid Array (FBGA), Option 3—Flip Chip”, “1508-Pin FineLine Ball-Grid Array (FBGA), Option 1—Flip Chip”, “1508-Pin FineLine Ball-Grid Array (FBGA), Option 2—Flip Chip”, “1517-Pin FineLine Ball-Grid Array (FBGA), Option 1—Flip Chip”, “1517-Pin FineLine Ball-Grid Array (FBGA), Option 2—Flip Chip”, “1760-Pin FineLine Ball-Grid Array (FBGA), Option 1—Flip Chip”, “1760-Pin FineLine Ball-Grid Array (FBGA), Option 2—Flip Chip”, “1932-Pin FineLine Ball-Grid Array (FBGA), Option 1—Flip Chip”, “1932-Pin FineLine Ball-Grid Array (FBGA), Option 2—Flip Chip”, “484-Pin Hybrid FineLine Ball-Grid Array (HBGA)—Flip Chip”, “780-Pin Hybrid FineLine Ball-Grid Array (HBGA)—Flip Chip”, “1517-Pin Hybrid FineLine Ball-Grid Array (HBGA), Option 1—Flip Chip”, “1517-Pin Hybrid FineLine Ball-Grid Array (HBGA), Option 2—Flip Chip”, “1152-Pin Hybrid FineLine Ball-Grid Array (HBGA), Option 1—Flip Chip”, “1152-Pin Hybrid FineLine Ball-Grid Array (HBGA), Option 2—Flip Chip”, “1152-Pin Hybrid FineLine Ball-Grid Array (HBGA), Option 3—Flip Chip”, and “1152-Pin Hybrid FineLine Ball-Grid Array (HBGA), Option 4—Flip Chip”.</li> <li data-bbox="420 926 1133 1104">■ Added package diagram: “144-Pin Plastic Enhanced Quad Flat Pack (EQFP)—Wire Bond (EP3C10)”, “148-Pin Quad Flat No-Lead Package (QFN)—Wire Bond”, “780-Pin FineLine Ball-Grid Array (FBGA), Option 4—Flip Chip”, “1152-Pin FineLine Ball-Grid Array (FBGA), Option 3—Flip Chip”, and “572-Pin FineLine Ball-Grid Array (FBGA)—Option 2, Flip Chip”.</li> <li data-bbox="420 1119 1133 1659">■ Added package diagram for Stratix IV devices: “1152-Pin FineLine Ball-Grid Array (FBGA)—Flip Chip—Single-Piece Lid (EP4SGX290)”, “780-Pin FineLine Ball-Grid Array (FBGA)—Flip Chip—Single-Piece Lid (EP4SGX110)”, “1152-Pin FineLine Ball-Grid Array (FBGA)—Flip Chip—Single-Piece Lid (EP4SGX110)”, “1152-Pin FineLine Ball-Grid Array (FBGA)—Flip Chip—Channel Lid (EP4SGX180)”, “1152-Pin FineLine Ball-Grid Array (FBGA)—Flip Chip—Single-Piece Lid (EP4SGX180)”, “1932-Pin FineLine Ball-Grid Array (FBGA)—Flip Chip—Single-Piece Lid (EP4SGX290)”, “780-Pin Hybrid FineLine Ball-Grid Array (HBGA)—Flip Chip—Channel Lid (EP4SGX360)”, “1517-Pin FineLine Ball-Grid Array (FBGA)—Flip Chip—Single-Piece Lid (EP4SGX360)”, “1760-Pin FineLine Ball-Grid Array (FBGA) — Flip Chip — Single-Piece Lid (EP4SGX360)”, “1517-Pin Hybrid FineLine Ball-Grid Array (HBGA)—Flip Chip—Dual-Piece Lid (EP4SE530)”, “1517-Pin Hybrid FineLine Ball-Grid Array (HBGA)—Flip Chip—Single-Piece Lid (EP4SE530)”, “780-Pin FineLine Ball-Grid Array (FBGA)—Flip Chip—Channel Lid (EP4SE230)”, and “1152-Pin Hybrid Ball-Grid Array (HBGA)—Flip Chip—Single-Piece Lid (EP4SE530)”.</li> </ul> |                    |

**Table 60.** Document Revision History (1) (Part 6 of 13)

| Date and Document Version | Changes Made   | Summary of Changes |
|---------------------------|--|--------------------|
|                           | <ul style="list-style-type: none"> <li data-bbox="423 306 1138 611">■ Added package diagram for Stratix III devices: “780-Pin FineLine Ball-Grid Array (FBGA)—Flip Chip—Dual-Piece Lid (EP3SL150)”, “780-Pin Hybrid FineLine Ball-Grid Array (HBGA)—Flip Chip—Dual-Piece Lid (EP3SL200)”, “1152-Pin FineLine Ball-Grid Array (FBGA)—Flip Chip—Dual-Piece Lid (EP3SE110)”, “780-Pin FineLine Ball-Grid Array (FBGA)—Flip Chip—Dual-Piece Lid (EP3SE110)”, “780-Pin Hybrid FineLine Ball-Grid Array (HBGA)—Flip Chip—Dual-Piece Lid (EP3SE260)”, “1152-Pin FineLine Ball-Grid Array (FBGA)—Flip Chip—Channel Lid (EP3SE260)”, and “1152-Pin FineLine Ball-Grid Array (FBGA)—Flip Chip—Dual-Piece Lid (EP3SE260)”.</li> <li data-bbox="423 621 1105 684">■ Added package diagram for Cyclone IV devices: “780-Pin FineLine Ball-Grid Array (FBGA)—Wire Bond—OMPAC (EP4CE115)”.</li> <li data-bbox="423 695 1138 1482">■ Added package diagram for Cyclone III devices :“780-Pin FineLine Ball-Grid Array (FBGA)—Wire Bond—OMPAC (EP3C120)”, “144-Pin Plastic Enhanced Quad Flat Pack (EQFP)—Wire Bond—(EP3C16)”, “256-Pin Ultra FineLine Ball-Grid Array (UBGA)—Wire Bond—Thin (EP3C10)”, “780-Pin FineLine Ball-Grid Array (FBGA)—Wire Bond—OMPAC (EP3C55)”, “144-Pin Plastic Enhanced Quad Flat Pack (EQFP)—Wire Bond—(EP3C25)”, “256-Pin FineLine Ball-Grid Array (FBGA)—Wire Bond—Thin (EP3C10)”, “780-Pin FineLine Ball-Grid Array (FBGA)—Wire Bond—OMPAC (EP3C80)”, “484-Pin FineLine Ball-Grid Array (FBGA)—Wire Bond—OMPAC (EP3C120)”, “256-Pin FineLine Ball-Grid Array (FBGA)—Wire Bond—Thin (EP3C16)”, “256-Pin FineLine Ball-Grid Array (FBGA)—Wire Bond—Thin (EP3C25)”, “324-Pin FineLine Ball-Grid Array (FBGA)—Wire Bond (EP3C25)”, “324-Pin FineLine Ball-Grid Array (FBGA)—Wire Bond (EP3C40)”, “484-Pin FineLine Ball-Grid Array (FBGA)—Wire Bond—OMPAC (EP3C16)”, “484-Pin FineLine Ball-Grid Array (FBGA)—Wire Bond—OMPAC (EP3C40)”, “484-Pin FineLine Ball-Grid Array (FBGA)—Wire Bond—OMPAC (EP3C55)”, “484-Pin FineLine Ball-Grid Array (FBGA)—Wire Bond—OMPAC (EP3C80)”, “484-Pin Ultra FineLine Ball-Grid Array (UBGA)—Wire Bond (EP3CLS100)”, “256-Pin Ultra FineLine Ball-Grid Array (UBGA)—Wire Bond—Thin (EP3C16)”, “484-Pin Ultra FineLine Ball-Grid Array (UBGA)—Wire Bond (EP3C16)”, “256-Pin Ultra FineLine Ball-Grid Array (UBGA)—Wire Bond—Thin (EP3C25)”, “484-Pin Ultra FineLine Ball-Grid Array (UBGA)—Wire Bond (EP3C55)”, and “484-Pin Ultra FineLine Ball-Grid Array (UBGA)—Wire Bond (EP3C80)”.</li> <li data-bbox="423 1493 1138 1587">■ Added package diagram for MAX II devices: “100-Pin FineLine Ball-Grid Array (FBGA)—Wire Bond—Thin (EPM240)”, “100-Pin FineLine Ball-Grid Array (FBGA)—Wire Bond—Thin (EPM570)”.</li> <li data-bbox="423 1598 1114 1770">■ Updated A3 dimension for “572-Pin FineLine Ball-Grid Array (FBGA)—Lidless—Flip Chip (EP2AGX45)”, “572-Pin FineLine Ball-Grid Array (FBGA)—Lidless—Flip Chip (EP2AGX65)”, “780-Pin FineLine Ball-Grid Array (FBGA)—Flip Chip—Lidless (EP2AGX45)”, and “780-Pin FineLine Ball-Grid Array (FBGA)—Flip Chip—Lidless (EP2AGX65)”.</li> </ul> |                    |

**Table 60.** Document Revision History (1) (Part 7 of 13)

| Date and Document Version | Changes Made   | Summary of Changes |
|---------------------------|--|--------------------|
|                           | <ul style="list-style-type: none"> <li>■ Added package diagram for HardCopy III devices: “484-Pin FineLine Ball-Grid Array (FBGA)—Flip Chip—Single-Piece Lid (HC325)” and “484-Pin FineLine Ball-Grid Array (FBGA)—Flip Chip—Lidless (HC325)”.</li> <li>■ Updated D1/E1 values in “1517-Pin FineLine Ball-Grid Array (FBGA)—Flip Chip—Single-Piece Lid (EP4S40G2)”, “1517-Pin FineLine Ball-Grid Array (FBGA)—Flip Chip—Single-Piece Lid (EP4S100G2)”, “1517-Pin FineLine Ball-Grid Array (FBGA)—Flip Chip—Single-Piece Lid (EP4SGX180)”, “1517-Pin FineLine Ball-Grid Array (FBGA)—Flip Chip—Single-Piece Lid (EP4SGX230)”, “484-Pin FineLine Ball-Grid Array (FBGA)—Flip Chip—Lidless (HC4E25)”, “780-Pin FineLine Ball-Grid Array (FBGA)—Flip Chip—Lidless (HC4E25)”, and “1020-Pin FineLine Ball-Grid Array (FBGA), Option 2—Flip Chip”.</li> <li>■ Updated Table 7.</li> <li>■ Updated Table 10 footnote.</li> <li>■ Updated thermal resistance values of EP3CLS70, EP3CLS100, EP3CLS150, and EP3CLS200 devices F484 pin package in Table 42.</li> <li>■ Updated package diagram in “1152-Pin FineLine Ball-Grid Array (FBGA)—Flip Chip—Single-Piece Lid (EP4SGX360)”</li> <li>■ Updated the notes in “256-Pin FineLine Ball-Grid Array (FBGA), Option 1—Wire Bond” and “256-Pin FineLine Ball-Grid Array (FBGA), Option 2—Thin—Wire Bond” to include Cyclone IV devices.</li> <li>■ Updated EP4SE230 device package to Channel Lid from Dual-Piece Lid in Table 4.</li> <li>■ Updated package diagram in “1517-Pin FineLine Ball-Grid Array (FBGA)—Flip Chip—Dual-Piece Lid (EP4SGX180)”.</li> <li>■ Updated EP1AGX50 and EP1AGX60 F484 pin package description from dual-piece lid to channel lid in Table 3.</li> <li>■ Updated EP4SGX180 and EP4SGX230 device package description in Table 4.</li> <li>■ Added note 1 to Table 6.</li> <li>■ Deleted HC315WF484 from Table 18.</li> <li>■ Added additional information to “148-Pin Quad Flat No-Lead Package (QFN)—Wire Bond—(EP4CGX15)” and “148-Pin Quad Flat No-Lead Package (QFN)—Wire Bond”</li> </ul> |                    |

**Table 60.** Document Revision History (1) (Part 8 of 13)

| Date and Document Version | Changes Made  | Summary of Changes       |
|---------------------------|---|--------------------------|
| April 2010                | <ul style="list-style-type: none"> <li>■ Added Table 1 and Table 38</li> <li>■ Updated Table 2 through Table 37</li> <li>■ Updated values in Table 49, Table 50, Table 58</li> <li>■ Removed 148-pin Quad Flat No-Lead Package (QFN)—Wire Bond, 484-Pin FBGA, Flip Chip, Dual-Piece Lid (EP2S15), 484-Pin FBGA, Flip Chip, Single-Piece Lid (EP2S15), 672-Pin FBGA, Flip Chip, Dual-Piece Lid (EP2S15), 672-Pin FBGA, Flip Chip, Single-Piece Lid (EP2S15) package outlines.</li> <li>■ Corrected title in 1152-Pin FineLine Ball-Grid Array (FBGA)—Flip Chip—Single-Piece Lid (HC4E35)</li> <li>■ Added 148-Pin Quad Flat No-Lead Package (QFN)—Wire Bond—(EP4CGX15)</li> <li>■ Added 1517-Pin FineLine Ball-Grid Array (FBGA)—Flip Chip—Single-Piece Lid (EP4S40G2), 1517-Pin FineLine Ball-Grid Array (FBGA)—Flip Chip—Single-Piece Lid (EP4S100G2), 1517-Pin Hybrid FineLine Ball-Grid Array (HBGA)—Flip Chip—Single-Piece Lid (EP4S40G5), and 1932-Pin FineLine Ball-Grid Array (FBGA)—Flip Chip—Single-Piece Lid (EP4S100G4)</li> <li>■ Added 1152-Pin Hybrid Ball-Grid Array (HBGA)—Flip Chip—Single-Piece Lid (EP4SE820), 1517-Pin Hybrid Ball-Grid Array (HBGA)—Flip Chip—Single-Piece Lid (EP4SE820), and 1760-Pin FineLine Ball-Grid Array (FBGA)—Flip Chip—Single-Piece Lid (EP4SE820)</li> <li>■ Added 1517-Pin FineLine Ball-Grid Array (FBGA)—Flip Chip—Single-Piece Lid (EP4SGX180) and 1517-Pin FineLine Ball-Grid Array (FBGA)—Flip Chip—Dual-Piece Lid (EP4SGX180)</li> <li>■ Added 1517-Pin FineLine Ball-Grid Array (FBGA)—Flip Chip—Dual-Piece Lid (EP4SGX230)</li> <li>■ Added “484-Pin FineLine Ball-Grid Array (FBGA)—Flip Chip—Lidless (HC4E25)”, “484-Pin FineLine Ball-Grid Array (FBGA)—Flip Chip—Single-Piece Lid (HC4E25)”, and “780-Pin FineLine Ball-Grid Array (FBGA)—Flip Chip—Lidless (HC4E25)”</li> <li>■ Added “780-Pin FineLine Ball-Grid Array (FBGA)—Flip Chip—Lidless (HC4GX15)”, and “780-Pin FineLine Ball-Grid Array (FBGA)—Flip Chip—Single-Piece Lid (HC4GX15)”</li> <li>■ Added “780-Pin FineLine Ball-Grid Array (FBGA)—Flip Chip—Lidless (HC4GX25)”, “780-Pin FineLine Ball-Grid Array (FBGA)—Flip Chip—Single-Piece Lid (HC4GX25)”, “1152-Pin FineLine Ball-Grid Array (FBGA)—Flip Chip—Lidless (HC4GX25)”, and “1152-Pin FineLine Ball-Grid Array (FBGA)—Flip Chip—Single-Piece Lid (HC4GX25)”</li> </ul> | Updated for version 16.1 |

**Table 60.** Document Revision History (1) (Part 9 of 13)

| Date and Document Version | Changes Made  | Summary of Changes       |
|---------------------------|---|--------------------------|
|                           | <ul style="list-style-type: none"> <li>■ Added “1152-Pin FineLine Ball-Grid Array (FBGA)—Flip Chip—Single-Piece Lid (HC4GX35)”, “1517-Pin FineLine Ball-Grid Array (FBGA)—Flip Chip—Lidless (HC4GX35)”, and “1517-Pin FineLine Ball-Grid Array (FBGA)—Flip Chip—Single-Piece Lid (HC4GX35)”</li> <li>■ Updated 1517-Pin FineLine Ball-Grid Array (FBGA)—Flip Chip—Single-Piece Lid (EP4SGX230)</li> <li>■ Corrected title for 324-Pin FineLine Ball-Grid Array (FBGA)—Wire Bond—Option 1 from 324-Pin FineLine Ball-Grid Array (FBGA)</li> <li>■ Corrected title for 1517-Pin Hybrid FineLine Ball-Grid Array (HBGA) — Flip Chip — Single-Piece Lid (EP4SE820) from 1517-Pin Hybrid FineLine Ball-Grid Array (HBGA)—Flip Chip—Single-Piece Lid (EP4SGX820)</li> <li>■ Corrected weight in 324-Pin FBGA Data Sheet</li> <li>■ Added thermal resistance disclaimer at the beginning of the Thermal Resistance section</li> <li>■ Moved EPC1, EPC2, EPC1441 entries from Table 27 to Table 37</li> </ul> |                          |
| December 2009             | <ul style="list-style-type: none"> <li>■ Added notes for preliminary thermal information (Table 36, Table 37, Table 46, and Table 47)</li> </ul>  | Updated for version 16.0 |

**Table 60.** Document Revision History (1) (Part 10 of 13)

| Date and Document Version | Changes Made  | Summary of Changes       |
|---------------------------|---|--------------------------|
| November 2009             | <ul style="list-style-type: none"> <li>■ Added Cyclone IV information</li> <li>■ Added notes to 1152-Pin HBGA Option 3 Data Sheet</li> <li>■ Corrected drawings for 358-Pin UBGA—Lidless (EP2AGX45), 358-Pin UBGA—Lidless (EP2AGX65), and 1152-Pin FBGA—Lidless (EP2AGX95) Data Sheets</li> <li>■ Added 148-Pin QFN, 169-Pin FBGA, and 324-Pin FBGA Option 2 Data Sheets</li> <li>■ Added 1517-Pin—Lidless (HC4E35) and 1517-Pin Single-Piece Lid (HC4E35) Data Sheets</li> <li>■ Added 780-pin FBGA—Channel Lid (EP4SGX230), 780-Pin HBGA—Channel Lid (EP4SGX 360), 1152-Pin FBGA—Channel Lid (EP4SGX230), 1152-Pin FBGA—Channel Lid (EP4SGX360), 1152-Pin FBGA—Dual-Piece Lid (EP4SGX230), 1152-Pin FBGA—Single-Piece Lid (EP4SGX230), 1152-Pin FBGA—Single-Piece Lid (EP4SGX360), 1152-Pin HBGA—Single-Piece Lid (EP4SGX530), 1152-Pin HBGA—Single-Piece Lid (EP4SGX820), 1517-Pin FBGA—Dual-Piece Lid (EP4SGX230), 1517-Pin FBGA—Single-Piece Lid (EP4SGX230), 1517-Pin FBGA—Single-Piece Lid (EP4SGX360), 1517-Pin HBGA—Dual-Piece Lid (EP4SGX530), 1517-Pin HBGA—Single-Piece Lid (EP4SGX530), 1517-Pin HBGA—Single-Piece Lid (EP4S40G2 and EP4S100G2), 1517-Pin HBGA—Single-Piece Lid (EP4S100G5), 1517-Pin HBGA—Single-Piece Lid (EP4SGX820), 1760-Pin FBGA—Dual-Piece Lid (EP4SGX530), 1760-Pin FBGA—Single-Piece Lid (EP4SGX360), 1760-Pin FBGA—Single-Piece Lid (EP4SGX820), 1932-Pin FBGA—Dual-Piece Lid (EP4SGX530), 1932-Pin FBGA—Single-Piece Lid (EP4SGX530), 1932-Pin FBGA—Single-Piece Lid (EP4S100G2) Data Sheets</li> <li>■ Added 484-Pin FBGA—Dual-Piece Lid (EP2S15), 484-Pin FBGA—Single-Piece Lid (EP2S15), 672-Pin FBGA—Dual-Piece Lid (EP2S15), 672-Pin FBGA—Single-Piece Lid (EP2S15), 164-Pin MBGA (EP3C16), and 484-Pin UBGA (EP3C40) Data Sheets</li> </ul> | Updated for version 15.9 |

**Table 60.** Document Revision History (1) (Part 11 of 13)

| Date and Document Version | Changes Made   | Summary of Changes       |
|---------------------------|--|--------------------------|
| October 2009              | <ul style="list-style-type: none"> <li>■ Added 1152-Pin HBGA Option 3, 1152-Pin HBGA Option 4, 1517-Pin HBGA Option 2, 1760-Pin FBGA Option 2, and 1932-Pin FBGA Option 2 Data Sheets</li> <li>■ Added 358-Pin UBGA—Lidless (EP2AGX45), 358-Pin UBGA—Lidless (EP2AGX65), 572-Pin FBGA—Lidless (EP2AGX45), 572-Pin FBGA—Lidless (EP2AGX65), 572-Pin FBGA—Lidless (EP2AGX95), 572-Pin FBGA—Lidless (EP2AGX125), 780-Pin FBGA—Lidless (EP2AGX45), 780-Pin FBGA—Lidless (EP2AGX65), 780-Pin FBGA—Lidless (EP2AGX95), 780-Pin FBGA—Lidless (EP2AGX125), 780-Pin FBGA—Lidless (EP2AGX190), 780-Pin FBGA—Lidless (EP2AGX260), 1152-Pin FBGA—Lidless (EP2AGX95), 1152-Pin FBGA—Lidless (EP2AGX125), 1152-Pin FBGA—Lidless (EP2AGX190), and 1152-Pin FBGA—Lidless (EP2AGX260) Data Sheets</li> <li>■ Added 780-Pin FBGA—Lidless (HC325), 780-Pin FBGA—Single-Piece Lid (HC325), 1152-Pin FBGA—Lidless (HC335), 1152-Pin FBGA—Single-Piece Lid (HC335), 1152-Pin FBGA—Lidless (HC4E35), 1152-Pin FBGA—Single-Piece Lid (HC4E35), 1517-Pin FBGA—Lidless (HC335), and 1517-Pin FBGA—Single-Piece Lid (HC335) Data Sheets</li> <li>■ Removed EP2AGX20 and EP2AGX30 entries from Table 2 and Table 39</li> <li>■ Added EP4SE820 entries to Table 41</li> <li>■ Added Stratix IV GT devices to Table 4; added option references</li> <li>■ Updated thermal resistance values in Table 39</li> </ul> | Updated for version 15.8 |
| June 2009                 | <ul style="list-style-type: none"> <li>■ Made three corrections to Stratix III thermal resistance table</li> <li>■ Added Cyclone III LS information</li> <li>■ Added Stratix IV GT thermal resistance values</li> <li>■ Added and/or HardCopy III and IV cross-reference and thermal resistance tables</li> <li>■ Updated HardCopy III and IV part numbers</li> <li>■ Added Cyclone III M164 package information</li> <li>■ Added 484-Pin FBGA Option 4, 672-Pin FBGA Option 4, 1020-Pin FBGA Option 2, 1508-Pin FBGA Option 2, and 1517-Pin Option 2 FBGA Data Sheets</li> <li>■ Revised 1508-Pin FBGA Option 1, 1020-Pin FBGA Option 1, 1517-Pin FBGA Option 1, 572-Pin FBGA, and 1152-Pin FBGA Option 2 Data Sheets</li> <li>■ Added 956-Pin BGA Option 2 Data Sheet</li> </ul>   | Updated for version 15.7 |
| March 2009                | <ul style="list-style-type: none"> <li>■ Corrected “b Nom.” value in 358-Pin UBGA Data Sheet</li> <li>■ Corrected “A Max.” value and replaced package drawing in 780-Pin FBGA - Option 3 Data Sheet</li> <li>■ Corrected “A Max.” value in 256-Pin UBGA Data Sheet</li> <li>■ Modified thermal resistance values for EP3SL200 device in Stratix III thermal resistance table</li> </ul>  | Updated for version 15.6 |

**Table 60.** Document Revision History (1) (Part 12 of 13)

| Date and Document Version | Changes Made  | Summary of Changes       |
|---------------------------|---|--------------------------|
| March 2009                | <ul style="list-style-type: none"> <li>■ Fixed theta symbols in several data sheet Dimension Tables</li> <li>■ Updated dimensions in 256-Pin UBGA Data Sheet</li> <li>■ Added 358-Pin UBGA Data Sheet, 572-Pin, 780-Pin Option 3, and 1152-Pin Option 2 FBGA Data Sheets</li> <li>■ Added Arria II GX thermal resistance table</li> <li>■ Added Arria II GX device and package cross-reference table</li> <li>■ Added EP3SL50, EP3SE80, and EP3SL110 devices to Stratix III thermal resistance table</li> <li>■ Added EP4SGX70, EP4SGX180, and EP4SGX290 devices and updated Stratix IV GX thermal resistance table</li> <li>■ Added HardCopy III and HardCopy IV thermal resistance table</li> <li>■ Miscellaneous formatting changes</li> </ul> | Updated for version 15.5 |
| December 2008             | <ul style="list-style-type: none"> <li>■ Changed dimension “A” Max. value in 1932-Pin FBGA Data Sheet</li> </ul>  | Updated for version 15.4 |
| November 2008             | <ul style="list-style-type: none"> <li>■ Moved Revision History to the end and added “How to Contact Altera” section</li> <li>■ Added subheadings in Thermal Resistance section</li> <li>■ Converted to 8-1/2 x 11 page size</li> <li>■ Changed “Maximum Lead Coplanarity” to “Lead Coplanarity” and added “(Typ.)” to weights for all packages</li> <li>■ Added EP2C15 information to Cyclone II tables</li> </ul>   | Updated for version 15.3 |
| September 2008            | <ul style="list-style-type: none"> <li>■ Added thermal resistance values for Stratix IV</li> <li>■ Added new 1152-Pin HBGA Option 2 (42.5 MM SQ.) Data Sheet</li> <li>■ Added new 1517-Pin HBGA (42.5 MM SQ.) Data Sheet</li> <li>■ Added theta-JB thermal resistance values for Stratix II</li> <li>■ Added HardCopy II thermal resistance values</li> <li>■ Revised weights for 256-Pin BGA Option 2, 652-Pin BGA Option 2, 652-Pin BGA Option 3, 208-Pin RQFP, 240-Pin RQFP, and 304-Pin RQFP Data Sheets</li> <li>■ Added notes to 1152-Pin FBGA, 1517-Pin FBGA, 1760-Pin FBGA; changed dimension “A” thickness and “A2” thickness in 1932-Pin FBGA Data Sheet</li> </ul>   | Updated for version 15.2 |
| May 2008                  | <ul style="list-style-type: none"> <li>■ Added 1932-Pin FBGA Data Sheet</li> <li>■ Added Device and Package Cross Reference table for Stratix IV</li> </ul>   | Updated for version 15.1 |
| April 2008                | <ul style="list-style-type: none"> <li>■ Revised Maximum Lead Coplanarity values for 1517-Pin FBGA and 1760-Pin FBGA Data Sheets</li> <li>■ Added three entries to Table 3</li> <li>■ Corrected minor typos in Table 4 and Table 10</li> <li>■ Corrected HC210W package in Table 12</li> <li>■ Many tables updated for formatting consistency</li> </ul>  | Updated for version 15.0 |

**Table 60.** Document Revision History (1) (Part 13 of 13)

| Date and Document Version | Changes Made   | Summary of Changes   |
|---------------------------|--|--|
| February 2008             | <ul style="list-style-type: none"> <li>■ Added 164-Pin MBGA information in Table 8</li> <li>■ Added HardCopy II device information in Table 12</li> <li>■ Updated Stratix III thermal resistance values in Table 22</li> <li>■ Added 164-Pin MBGA Data Sheet</li> <li>■ Corrected 8-Pin SOIC Data Sheet (changed “B” to “b” in Package Outline Dimension Table)</li> <li>■ Corrected 68-Pin MBGA Data Sheet (changed “Inches” to “Millimeters” in Package Outline Dimension Table)</li> </ul>  | Updated for version 14.9   |
| October 2007              | <ul style="list-style-type: none"> <li>■ Removed note from 100-Pin PQFP Option 1 Data Sheet</li> <li>■ Removed 100-Pin PQFP Option 2 Data Sheet</li> <li>■ Updated 88-Pin UBGA, 144-Pin EQFP, 256-Pin FBGA Option 1, 256-Pin FBGA Option 2, 256-Pin UBGA, 1517-Pin FBGA, and 1760-Pin FBGA Data Sheets</li> <li>■ Added 780-Pin HBGA and 1152-Pin HBGA Data Sheets</li> </ul>  | Updated for version 14.8   |
| May 2007 v14.7            | <ul style="list-style-type: none"> <li>■ Added Arria™ GX information</li> <li>■ Added Cyclone III tables</li> <li>■ Revised D2 and E2 dimensions for 144-Pin EQFP</li> <li>■ Revised 100-Pin MBGA - Wire Bond and 256-Pin MBGA - Wire Bond</li> <li>■ Added 780-Pin FBGA option 2 - Wire Bond, 256-Pin UBGA - Wire Bond, 68-Pin MBGA - Wire Bond, and 144-Pin MBGA - Wire Bond</li> </ul>  | Changes and additions as described in “Changes Made” section   |
| February 2007 v14.6       | <ul style="list-style-type: none"> <li>■ Updated 144-Pin Plastic Thin Quad Flat Pack (TQFP) Data Sheet to correct title and ordering code reference</li> <li>■ Added revision history</li> </ul>   | Revised one data sheet (144-Pin Plastic Thin Quad Flat Pack (TQFP) Data Sheet), added revision history |
| December 2006 v14.5       | <ul style="list-style-type: none"> <li>■ Table 2 was added for Stratix III Device and Package Cross-Reference</li> <li>■ Tables 16, 17, and 18 were added for Stratix III Thermal Resistance information</li> <li>■ 1517-Pin FineLine Ball-Grid Array (FBGA) - Flip Chip data sheet was added</li> <li>■ 1760-Pin FineLine Ball-Grid Array (FBGA) - Flip Chip data sheet was added</li> <li>■ “Wire Bond” and “Flip Chip” was added to title of each data sheet, as appropriate</li> <li>■ “BGA” was spelled out as “Ball-Grid Array” in all titles</li> <li>■ Some package outline drawings were reformatted</li> <li>■ Weights were updated for many packages</li> </ul> | Added Tables for Stratix III, updated other data sheets  |

**Note to Table 60:**

(1) Formal revision history for this document began with version 14.5.

## How to Contact Altera

For the most up-to-date information about Altera® products, see the following table.

| Contact <i>(Note 1)</i>                                 | Contact Method | Address  |
|---|----------------|--|
| Technical support                                       | Website        | <a href="http://www.altera.com/support">www.altera.com/support</a>     |
| Technical training                                      | Website        | <a href="http://www.altera.com/training">www.altera.com/training</a>   |
|   | Email          | <a href="mailto:custrain@altera.com">custrain@altera.com</a>           |
| Altera literature services                              | Email          | <a href="mailto:literature@altera.com">literature@altera.com</a>       |
| Non-technical support (General)<br>(Software Licensing) | Email          | <a href="mailto:nacomp@altera.com">nacomp@altera.com</a>               |
|   | Email          | <a href="mailto:authorization@altera.com">authorization@altera.com</a> |

**Note:**

(1) You can also contact your local Altera sales office or sales representative.



101 Innovation Drive  
San Jose, CA 95134  
[www.altera.com](http://www.altera.com)  
Technical Support  
[www.altera.com/support](http://www.altera.com/support)

Copyright © December 2011. Altera Corporation. All rights reserved. Altera, The Programmable Solutions Company, the stylized Altera logo, specific device designations, and all other words and logos that are identified as trademarks and/or service marks are, unless noted otherwise, the trademarks and service marks of Altera Corporation in the U.S. and other countries. All other product or service names are the property of their respective holders. Altera products are protected under numerous U.S. and foreign patents and pending applications, maskwork rights, and copyrights. Altera warrants performance of its semiconductor products to current specifications in accordance with Altera's standard warranty, but reserves the right to make changes to any products and services at any time without notice. Altera assumes no responsibility or liability arising out of the application or use of any information, product, or service described herein except as expressly agreed to in writing by Altera Corporation. Altera customers are advised to obtain the latest version of device specifications before relying on any published information and before placing orders for products or services.



I.S. EN ISO 9001

## Looking for pricing, stock, or lifecycle information?

Click below to explore more details on WIN SOURCE:

 [View EP1C20F400C7 on WIN SOURCE](#)

 [Altera Information](#)

## Optimize Your Supply Chain with WIN SOURCE Solutions

-  Global Sourcing Solution
-  Obsolete Management
-  Cost Control Management
-  Shortage Management
-  Alternative Solution
-  Excess Inventory Management