



**THE DATASHEET OF
ECS-36-20-5PX-TR**



The CSM-7X is an excellent choice for a low cost SMD Crystal. The CSM-7X (5PX) has a case height of 4.3 mm Max. in a resistance weld metal package. Lower profile package height of 3.2 mm is available with the (5PLX) package.

[Request a Sample](#)

CSM-7X SMD CRYSTAL



- Cost Effective
- Low Profile
- Industry Standard Footprint
- Pb Free/RoHS Compliant

DIMENSIONS (mm)

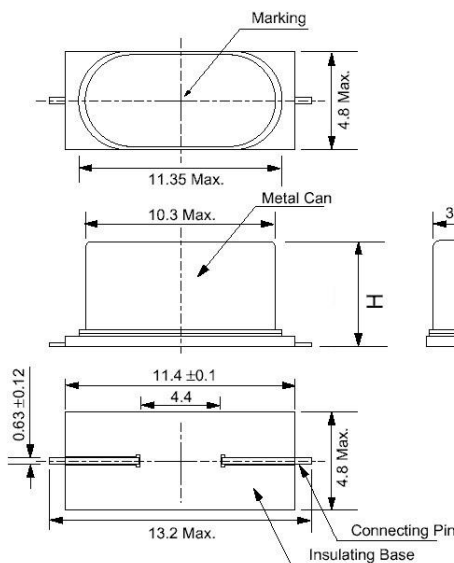

Height "H" Max.

-5PX	4.3 mm
5PLX	3.2 mm

OPERATING CONDITIONS / ELECTRICAL CHARACTERISTICS

PARAMETERS	CONDITIONS	CSM-7X			UNITS
		MIN	TYP	MAX	
Frequency		3.57		70.000	MHz
Frequency Tolerance*	@ +25°C			± 30	ppm
Frequency Stability*	Standard -10 ~ +70°C			± 50	ppm
Shunt Capacitance	Co			7	pF
Load Capacitance	Specify in P/N	10	20	Series	pF
Drive Level	DL			500	μW
Operating Temperature*	T _{opr}	-10		+70	°C
Storage Temperature	T _{stg}	-55		+125	°C
Aging (First Year)	@ +25°C ±3°C			±5	ppm

EQUIVALENT SERIES RESISTANCE/MODE OF OSCILLATION

Frequency (MHz)	ESR Ω Max.	Mode of Osc.
3.57 ~ 4.999	150	Fundamental
5.000 ~ 5.999	80	Fundamental
6.000 ~ 6.999	70	Fundamental
7.000 ~ 8.999	60	Fundamental
9.000 ~ 12.999	50	Fundamental
13.000 ~ 19.999	40	Fundamental
20.000 ~ 40.000	30	Fundamental
40.000 ~ 70.000	80	3 rd Overtone

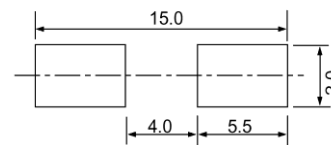

Figure 1) Top, Side, Bottom, and End

Crystal is symmetrical, pin 1 & 2 are interchangeable.

Figure 2) Suggested land

PART NUMBERING GUIDE: Example ECS-200-20-5PX-TR

ECS - FREQUENCY ABBREVIATION	LOAD CAPACITANCE	PACKAGE	AVAILABLE OPTIONS			PACKAGING
			Tolerance	Stability	Temp Range	
ECS	200 = 20.000 MHz See P/N Guide	5PX = 4.3 mm 5PLX = 3.2 mm	Blank = Std A = ± 25 ppm J = ± 20 ppm R = ± 15 ppm C = ± 10 ppm	Blank = Std D = ± 100 ppm E = ± 50 ppm G = ± 30 ppm H = ± 25 ppm T = ± 20 ppm † W = ± 15 ppm † K = ± 10 ppm †	Blank = Std L = -10 ~ +70°C M = -20 ~ +70°C Y = -30 ~ +85°C N = -40 ~ +85°C P = -40 ~ +105°C S = -40 ~ +125°C U = -55 ~ +125°C	TR = Tape & Reel 1K/Reel

* Specify available options in P/N.

† Contact ECS for availability over extended temp range.

Rev.2020

POCKET TAPE DIMENSIONS (mm)



A	B	C	D	F	J	L	M	Reel Dia.	Qty/Reel
15.4	5.3	24.0	11.5	12.0	1.7	0.4	4.4	300	1000pcs

SOLDER PROFILE

Peak solder Temp +260°C Max 10 sec Max.

2 Cycles Max.

MSL 1, Lead Finish Sn/Cu Matte

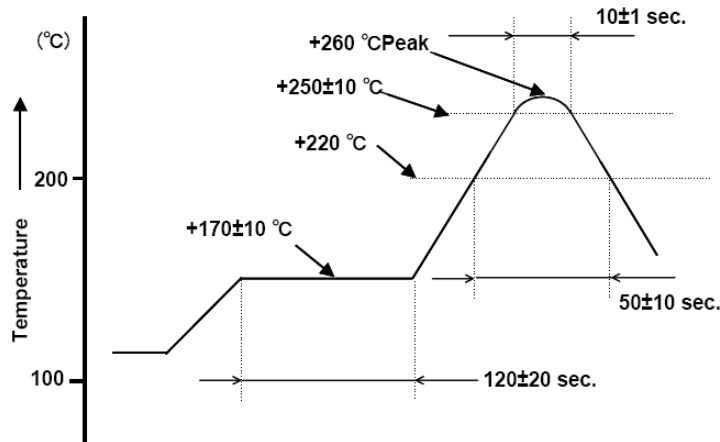

Figure 1) Suggested Reflow Profile

Looking for pricing, stock, or lifecycle information?

Click below to explore more details on WIN SOURCE:

 [View ECS-36-20-5PX-TR on WIN SOURCE](#)

 [ECS Inc. Information](#)

Optimize Your Supply Chain with WIN SOURCE Solutions

-  Global Sourcing Solution
-  Obsolete Management
-  Cost Control Management
-  Shortage Management
-  Alternative Solution
-  Excess Inventory Management