



**THE DATASHEET OF
ABS05W-32.768KHZ-D-2-T**



32.768KHZ IoT OPTIMIZED SMD CRYSTAL



ABS05W

1.6 x 1.0 x 0.5 mm

RoHS/RoHS II Compliant

MSL = N/A: NOT APPLICABLE

FEATURES

- Exceptionally low plating load of 4.0pF, ideal for wearables, wireless, and IoT applications
- Simultaneously optimized for ESR over extended operating temperature range
- Miniature 1.6 x 1.0 x 0.5 mm SMD package, ideally suited for space constrained designs
- Available with ± 20 ppm set tolerance
- Seam sealed package for long term reliability

APPLICATIONS

- Wearables
- Wireless Modules
- Internet of Things (IoT)
- Bluetooth/Bluetooth Low Energy (BLE)
- Machine-to-Machine (M2M) Connectivity
- Ultra Low Power MCU
- Near Field Communication (NFC)
- ISM Band Applications
- Ultra low power, energy saving MCU

STANDARD SPECIFICATIONS

PARAMETERS	MINIMUM	TYPICAL	MAXIMUM	UNITS	NOTES
Frequency	32.768			kHz	
Operation Mode	Flexural Mode (Tuning Fork)				
Operating Temperature	-40		+125	°C	See options
Storage Temperature	-55		+125	°C	
Frequency Tolerance @ +25°C	-20		+20	ppm	Refer to Note #1
Shift through standard RoHS Reflow, (2) reflow cycles maximum	-2.00		+2.00	ppm	260°C peak maximum reflow temperature, relative to stand-alone set-tolerance frequency
Temperature Coefficient:	-0.04	-0.03	-0.02	ppm/T ²	
Turn-over temperature:	+20	+25	+30	°C	
Frequency Stability Over Operating Temperature, relative to in-circuit measured frequency post reflow	-200		1	ppm	Over -40°C to +85°C
	-300		1	ppm	Over -40°C to +105°C
	-450		1	ppm	Over -40°C to +125°C
Load capacitance (CL)	4			pF	Refer to Note #2
Equivalent Series Resistance (ESR)		< 50	60	kΩ	@ +25±3°C
		< 55	70	kΩ	Over -40°C to +85°C
		< 60	75	kΩ	Over -40°C to +105°C
		< 65	85	kΩ	Over -40°C to +125°C
Shunt capacitance (C0)		1.45	2.0	pF	Combined Electrode & Package Capacitance
Motional Capacitance (C1)		7.91		fF	C1 also referred as Cm
Motional Inductance (L1)		2,987,787		mH	L1 also referred as Lm
Drive Level		0.1	0.5	μW	
Crystal sensitivity to closed-loop oscillator loading (Ts)	115	122	140	ppm/pF	Refer to Note #3
Q value	8,000	14,000			Quality Factor
Aging @ +25°C±3°C [First Year]	-3		+3	ppm	Relative to post reflow measured frequency
Aging @ +25°C±3°C [Over 10-years]	-15		+15	ppm	Relative to post reflow measured frequency
Insulation Resistance	500			MΩ	@ 100Vdc ± 15V

Note #1: With an effective loop capacitance of 4.0pF, the oscillator circuit will be within set-tolerance specification; less any frequency shift due to the reflow process.

Note #2: The oscillator loop needs to present an effective loop capacitance of 4.0 pF to track the stand-alone crystal frequency. This loop capacitance is essential to ensure highest possible Closed-Loop Safety Factor for the entire population of crystals.

Note #3: $T_s = - (C1) / [2*(C0 + CL)^2]$ Where CL = 4pF

32.768KHZ IoT OPTIMIZED SMD CRYSTAL



ABS05W

1.6 x 1.0 x 0.5 mm



RoHS/RoHS II Compliant

MSL = N/A: NOT APPLICABLE

OPTIONS AND PART IDENTIFICATION

ABS05W - 32.768kHz - ○ - ○ - ○

OPERATING TEMP RANGE
D: -40°C ~ +85°C
J: -40°C ~ +105°C
K: -40°C ~ +125°C

Freq. Tolerance
2: ±20ppm

PACKAGING
Blank: Bulk
T: Tape & Reel (5,000pcs/reel)

TYPICAL FREQUENCY TOLERANCE DISTRIBUTION (AT 25°C ± 3°C)

TYPICAL ESR DISTRIBUTION (AT 25°C ± 3°C)

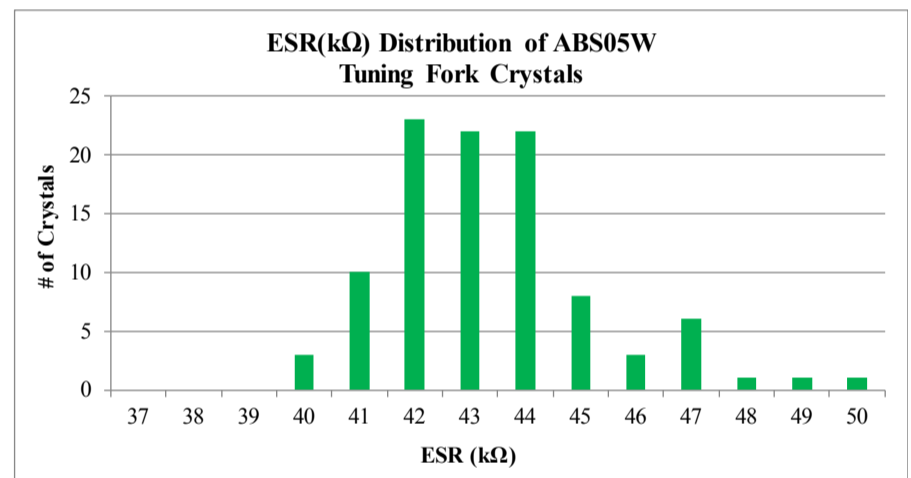
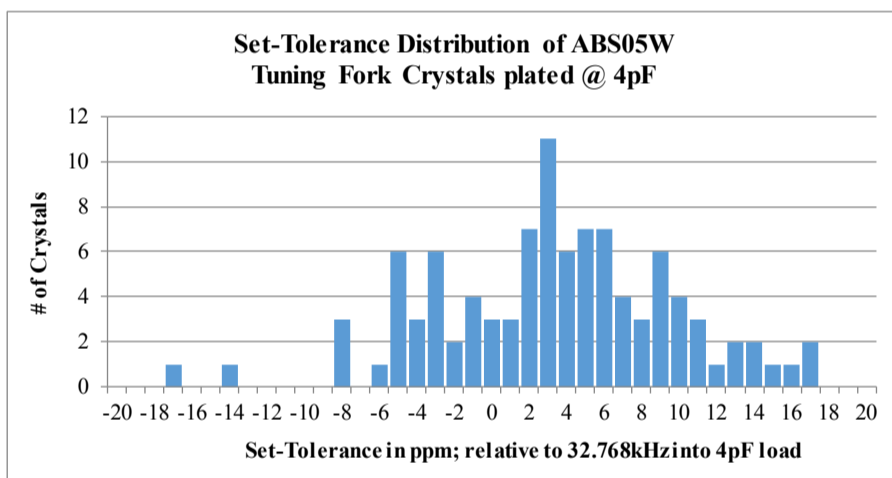

The data above reflects typical distribution, lot-to-lot variation applies

TYPICAL FREQUENCY Vs. TEMPERATURE CHARACTERISTICS

TYPICAL ESR (EQUIVALENT SERIES RESISTANCE) VS. TEMPERATURE CHARACTERISTICS

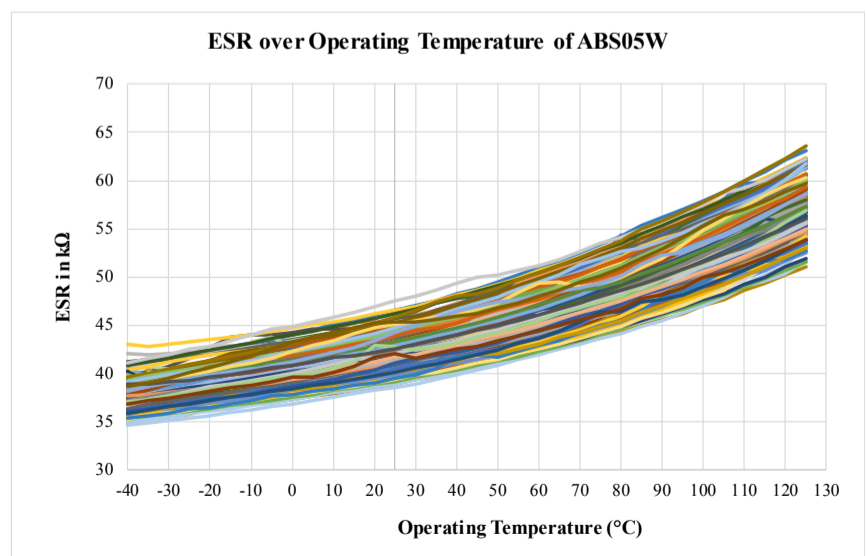
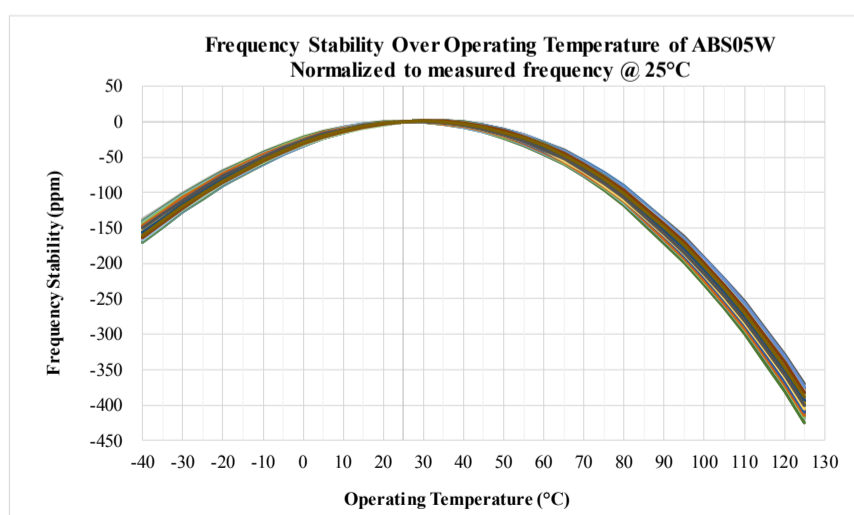

32.768KHZ IoT OPTIMIZED SMD CRYSTAL



ABS05W

1.6 x 1.0 x 0.5 mm

RoHS/RoHS II Compliant
MSL = N/A: NOT APPLICABLE

SPICE MODEL (BASED ON TYPICAL VALUES AT 25°C ± 3°C):

Quartz Crystal Equivalent Circuit

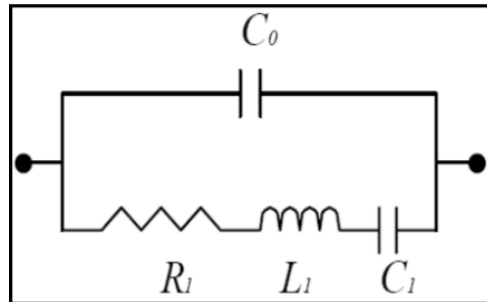

Frequency: 32.78kHz

Plating Load (CL) = 4pF

C0 = 1.45 pF

R1 = 43,394 Ω

L1 = 2,987,787mH

C1 = 7.91 fF

MECHANICAL DIMENSIONS

Dimensions: mm

Typical Weight: 2.7 mg

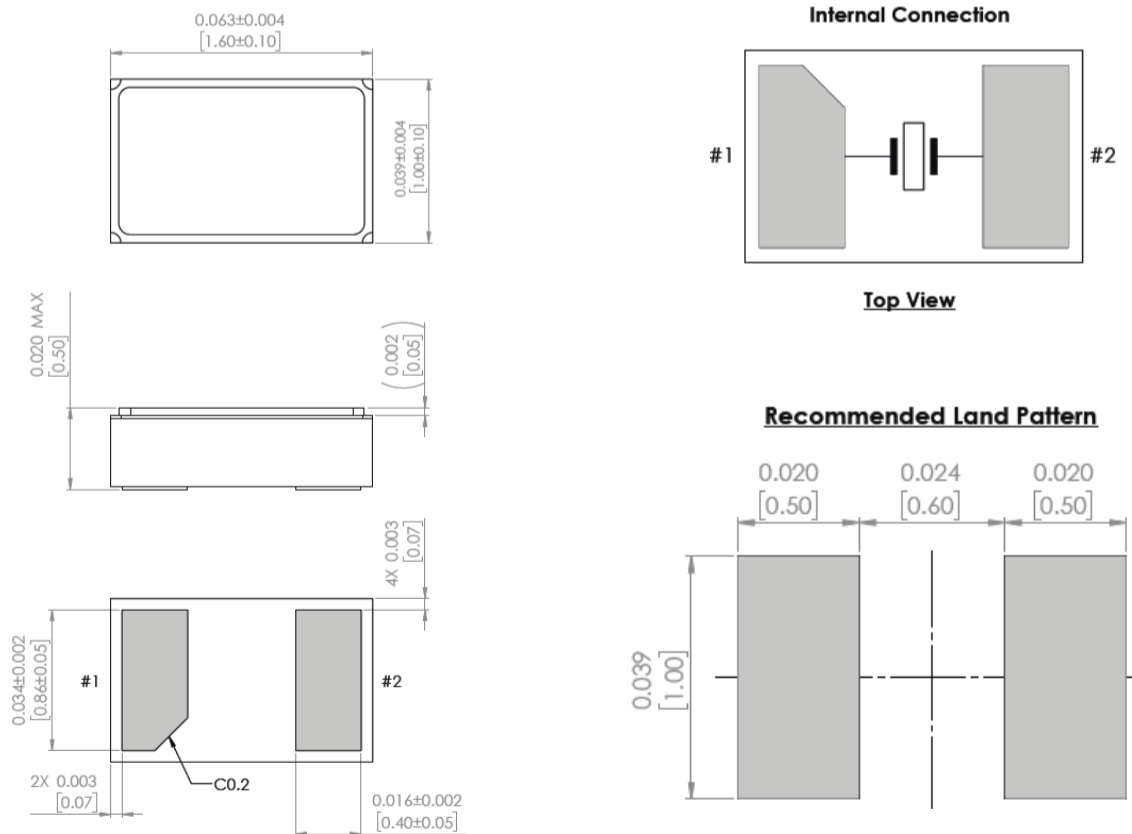

32.768KHZ IoT OPTIMIZED SMD CRYSTAL



ABS05W

1.6 x 1.0 x 0.5 mm



RoHS/RoHS II Compliant

MSL = N/A: NOT APPLICABLE

RECOMMENDED REFLOW PROFILE

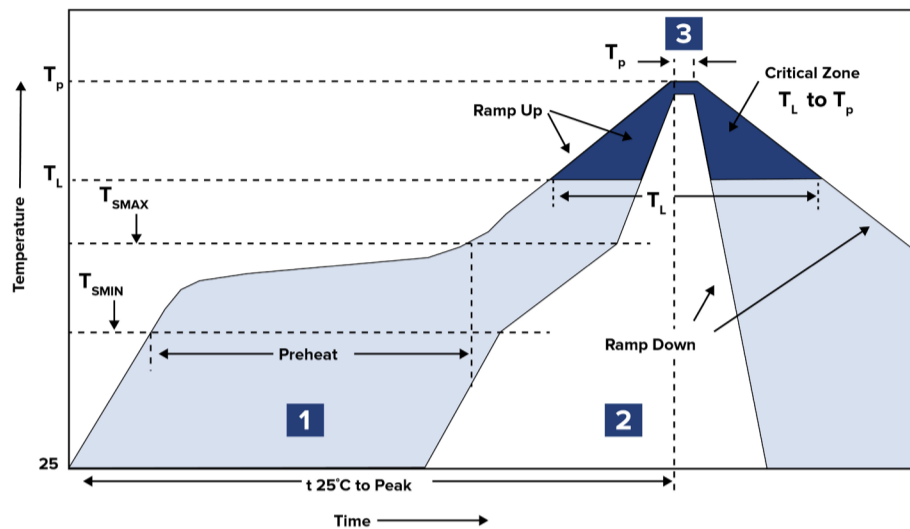

Zone	Description	Temperature	Time
1	Preheat / Soak	$T_{SMIN} \sim T_{SMAX}$ 150°C ~ 170°C	80 ~ 100 sec.
2	Reflow	T_L 220°C	50 ~ 70 sec.
3	Peak Heat	T_P 260°C ±5°C	5 sec. MAX

PACKAGING

TAPE AND REEL (5,000PCS/REEL)

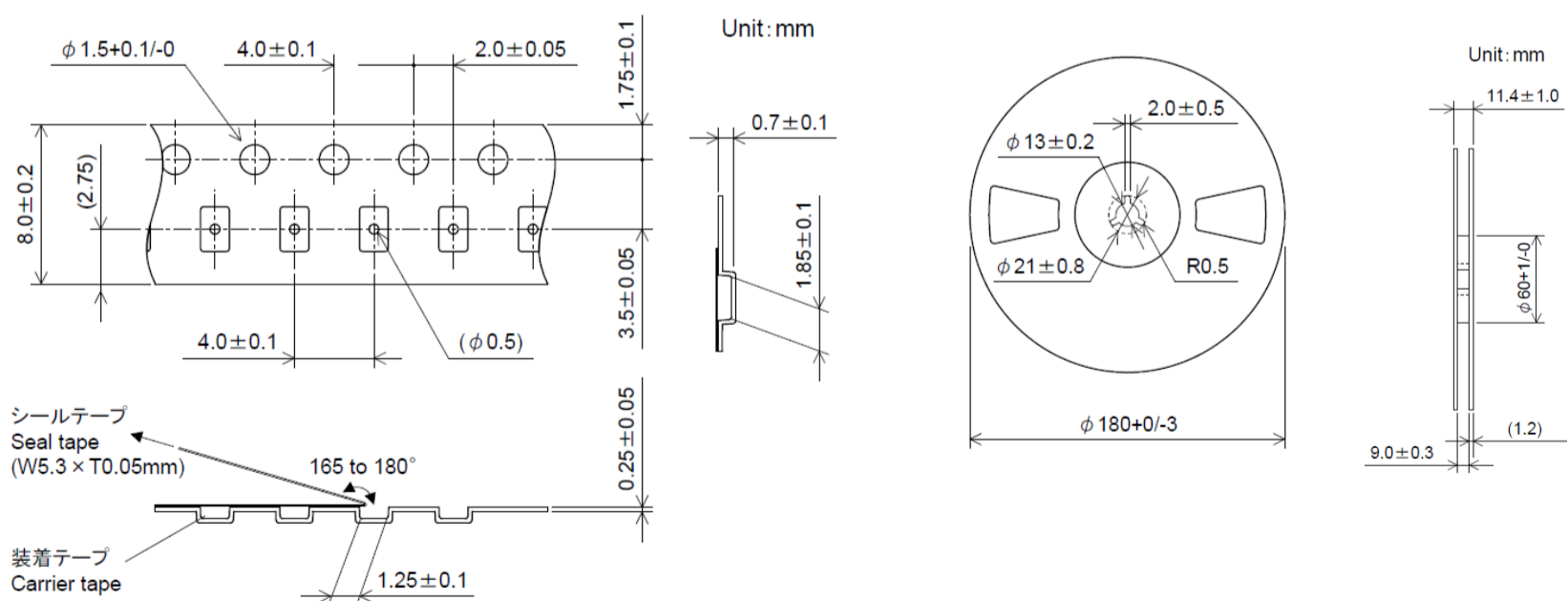

DIMENSIONS: mm

Looking for pricing, stock, or lifecycle information?

Click below to explore more details on WIN SOURCE:

- [View ABS05W-32.768KHZ-D-2-T on WIN SOURCE](#)
- [Abracon LLC Information](#)

Optimize Your Supply Chain with WIN SOURCE Solutions

- ✓ Global Sourcing Solution
- ✓ Obsolete Management
- ✓ Cost Control Management
- ✓ Shortage Management
- ✓ Alternative Solution
- ✓ Excess Inventory Management