



2.0×1.6mm for Consumer Products/ Automotive



Features

- Support a wide range of applications
- Ultra-miniature and low profile (2.0×1.6×0.45mm)
- Ceramic package
- Reflow compatible

Applications

- ECU
- Automotive Camera
- Digital Electronics
- Consumer Products

How to Order

CX2016SA 20000 D0 G S S □□
① ② ③ ④ ⑤ ⑥ ⑦

①Series	②Frequency
③Load Capacitance	④Frequency Tolerance
D0 8 pF	G ±15×10 ⁻⁶
⑤Operating Temp. Range	⑥Frequency Temp. Stability
SS -40 to +125°C	±50×10 ⁻⁶
TW -40 to +150°C	±200×10 ⁻⁶
LL -30 to +85°C	±20×10 ⁻⁶

⑦Individual Specification

Packaging (Tape & Reel 3000/ 15000 pcs./ reel)



Specifications

Item	Symbol	Specification	Unit	Remarks
Frequency Range	f _{nom}	16 / 20 / 24 / 25 / 26 / 27 / 30 / 32 / 37.4 / 38.4 / 40 / 48 / 50	MHz	Please contact us for other frequency range.
Overtone Order	OT	Fundamental	—	
Load Capacitance	CL	8	pF	Please contact us for other CL requirements.
Frequency Tolerance	f _{tol}	±15	×10 ⁻⁶	25°C±3°C
Motional Series Resistance	R1	Table 1	ohm	
Drive Level	DL	10μW(200μW max.)	μW	
Operating Temp. Range	T _{use}	-40 to +125 -40 to +150 -30 to +85	°C	
Storage Temp. Range	T _{stg}	-40 to +150	°C	
Frequency Temp. Characteristics	f _{tem}	±50 ±200 ±20	×10 ⁻⁶	Freq. deviation from the value at 25°C

Please contact us for other specifications.

Table 1 Motional Series Resistance Please contact us for other frequency range.

Frequency Range	Motional Series Resistance
16MHz	200 Ω max.
20MHz	150 Ω max.
32MHz	60 Ω max.
50MHz	50 Ω max.

Dimensions

(Unit: mm)

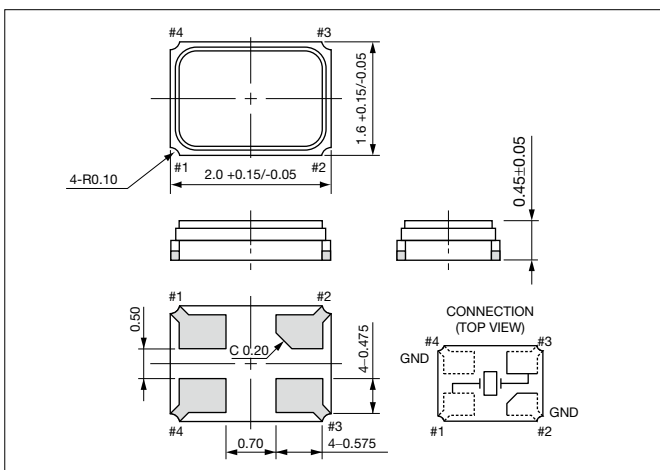

Recommended Land Pattern

(Unit: mm)

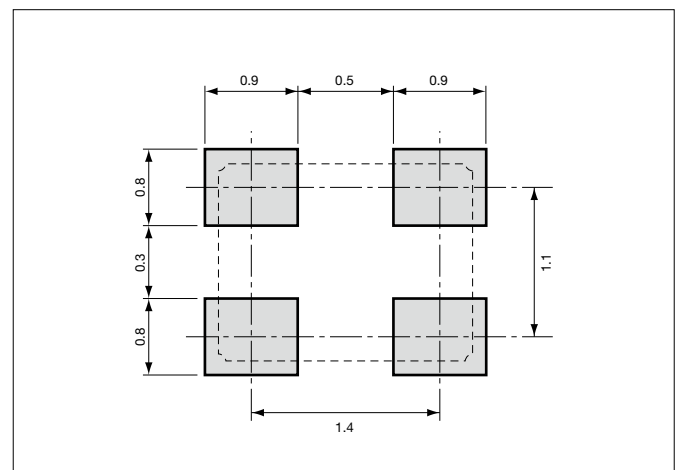

Looking for pricing, stock, or lifecycle information?

Click below to explore more details on WIN SOURCE:

- ⊖ [View CX2016SA25000D0GSSCC on WIN SOURCE](#)
- ⊖ [AVX Corp/Kyocera Corp Information](#)

Optimize Your Supply Chain with WIN SOURCE Solutions

- ✓ Global Sourcing Solution
- ✓ Obsolete Management
- ✓ Cost Control Management
- ✓ Shortage Management
- ✓ Alternative Solution
- ✓ Excess Inventory Management