

Plastic Film Capacitors

Metallized Polyester Film Capacitor

ECQE(F) series

Non-inductive construction using metallized polyester film with flame retardant epoxy resin coating

Features

- Self-healing property
- Excellent electrical characteristics
- Flame retardant epoxy resin coating
- RoHS compliant

Recommended applications

- General purpose usage
※Please contact us when applications are CDI , ignitor etc.

Explanation of part number

| | | | | | | | | | | | |
|--------------|----------|---------------------------|----------|---------------|---|-------------|---|---|-----------|----------|----------|
| 1 | 2 | 3 | 4 | 5 | 6 | 7 | 8 | 9 | 10 | 11 | 12 |
| E | C | Q | E | | | | | | | F | |
| Product code | | Dielectric & construction | | Rated voltage | | Capacitance | | | Cap. Tol. | Suffix 1 | Suffix 2 |

| Code | R.voltage |
|------|-------------|
| 1 | 100 V [DC] |
| 2 | 250 V [DC] |
| 4 | 400 V [DC] |
| 6 | 630 V [DC] |
| 10 | 1000 V [DC] |
| 12 | 1250 V [DC] |
| 1A | 125 V [AC] |
| 2A | 250 V [AC] |

| Code | Cap. Tol. |
|------|-----------|
| J | ±5 % |
| K | ±10 % |

| Code | Lead form |
|-------|-----------------------|
| Blank | Straight |
| B | Crimped lead |
| Z | Cut lead |
| 3 | Crimped taping (Ammo) |
| 6 | Crimped taping (Ammo) |

- Odd size taping

| | | | | | | | | | | | |
|--------------|----------|---------------------------|----------|---------------|---|-------------|---|---|------------|-----------|----------|
| 1 | 2 | 3 | 4 | 5 | 6 | 7 | 8 | 9 | 10 | 11 | 12 |
| E | C | Q | E | | | | | | R | | F |
| Product code | | Dielectric & construction | | Rated voltage | | Capacitance | | | Odd taping | Cap. Tol. | Suffix |

Specifications

| | | |
|--|---|--|
| Category temp. range (Including temperature-rise on unit surface) | 100V to 1250V [DC] | -40 °C to +105 °C |
| | 125 V, 250 V [AC] | -40 °C to +105 °C |
| Rated voltage | 100 V, 250 V, 400 V, 630 V, 1000 V, 1250 V [DC] (Derating of rated voltage by 1.25 %/°C at more than 85 °C) 125 V, 250 V [AC] | |
| Capacitance range | 100 V [DC] | 0.56 µF to 10.0 µF (E12) |
| | 250 V [DC] | 0.010 µF to 10.0 µF (E12) |
| | 400 V [DC] | 0.010 µF to 2.2 µF (E12) |
| | 630 V [DC] | 0.0056 µF to 2.2 µF (E12) |
| | 1000 V [DC] | 0.010 µF to 0.22 µF (E12) |
| | 1250 V [DC] | 0.0033 µF to 0.22 µF (E12) |
| | 125 V [AC] | 0.010 µF to 0.068 µF (E12) |
| | 250 V [AC] | 0.010 µF to 2.2 µF (E12) |
| Capacitance tolerance | ±5 % (J), ±10 % (K) | |
| Dissipation factor (tan δ) | tan δ ≤ 1.0 % (20 °C, 1 kHz) | |
| Withstand voltage | 100V to 630V [DC] | Between terminals : R.voltage (V [DC]) × 150 %, 60 s |
| | 1000 V [DC] 1250 V [DC] | Between terminals : R.voltage (V) × 175 %, 2 s to 5 s or 1000 V [AC], 60 s Between terminals to enclosure : 1500 V [AC], 60 s |
| | 125 V [AC] 250 V [AC] | Between terminals : R.voltage (V) × 230 %, 60 s Between terminals to enclosure : 1500 V [AC], 60 s |
| | | |
| Insulation resistance (IR) | 100V to 630V [DC] | C ≤ 0.33 µF : IR ≥ 9000 MΩ (20 °C, 100 V [DC], 60 s) C > 0.33 µF : IR ≥ 3000 MΩ · µF (20 °C, 100 V [DC], 60 s) |
| | 1000 V [DC] 1250 V [DC] | IR ≥ 10000 MΩ (20 °C, 100 V [DC], 60 s) IR ≥ 2000 MΩ (20 °C, 500 V [DC], 60 s) |
| | 125 V [AC] 250 V [AC] | C ≤ 0.47 µF : IR ≥ 2000 MΩ (20 °C, 500 V [DC], 60 s) C > 0.47 µF : IR ≥ 3000 MΩ · µF (20 °C, 100 V [DC], 60 s) |
| | | |

- * In case of applying voltage in alternating current (50 Hz or 60 Hz sine wave) to a capacitor with DC rated voltage, please refer to the page of "Permissible voltage (R.M.S) in alternating current corresponding to DC rated voltage".
- * Voltage to be applied to ECQE1A (F) & ECQE2A (F) is only sine wave (50 Hz or 60 Hz).

Dimensions

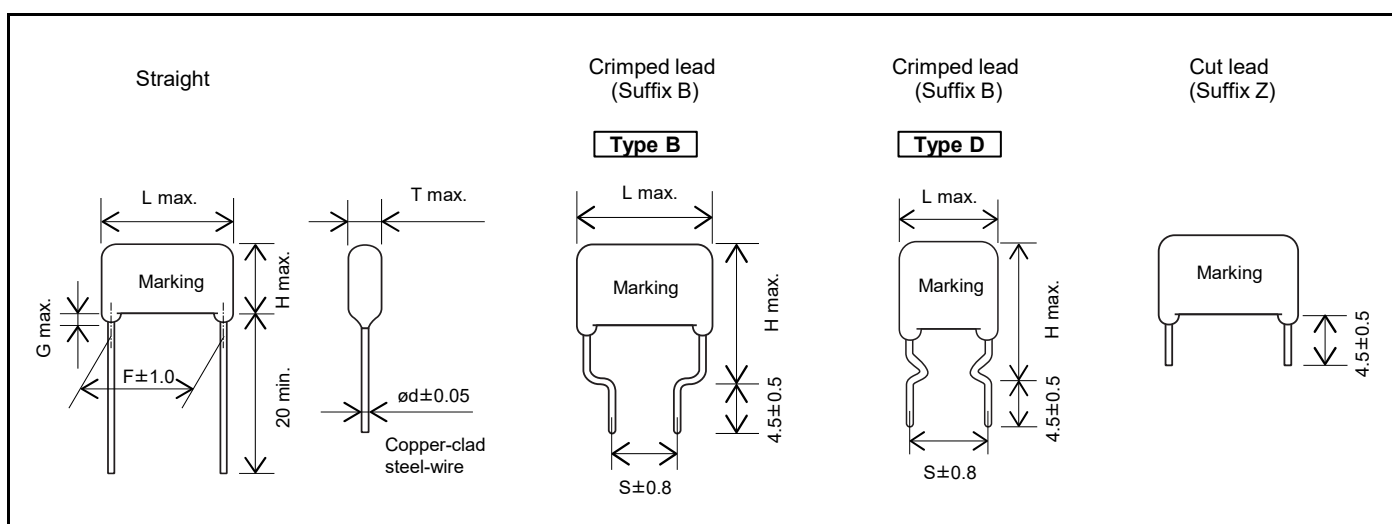

Packaging specifications for bulk package

- Packing quantity : 100 pcs./bag

Taping specifications for automatic insertion

■ Taping style

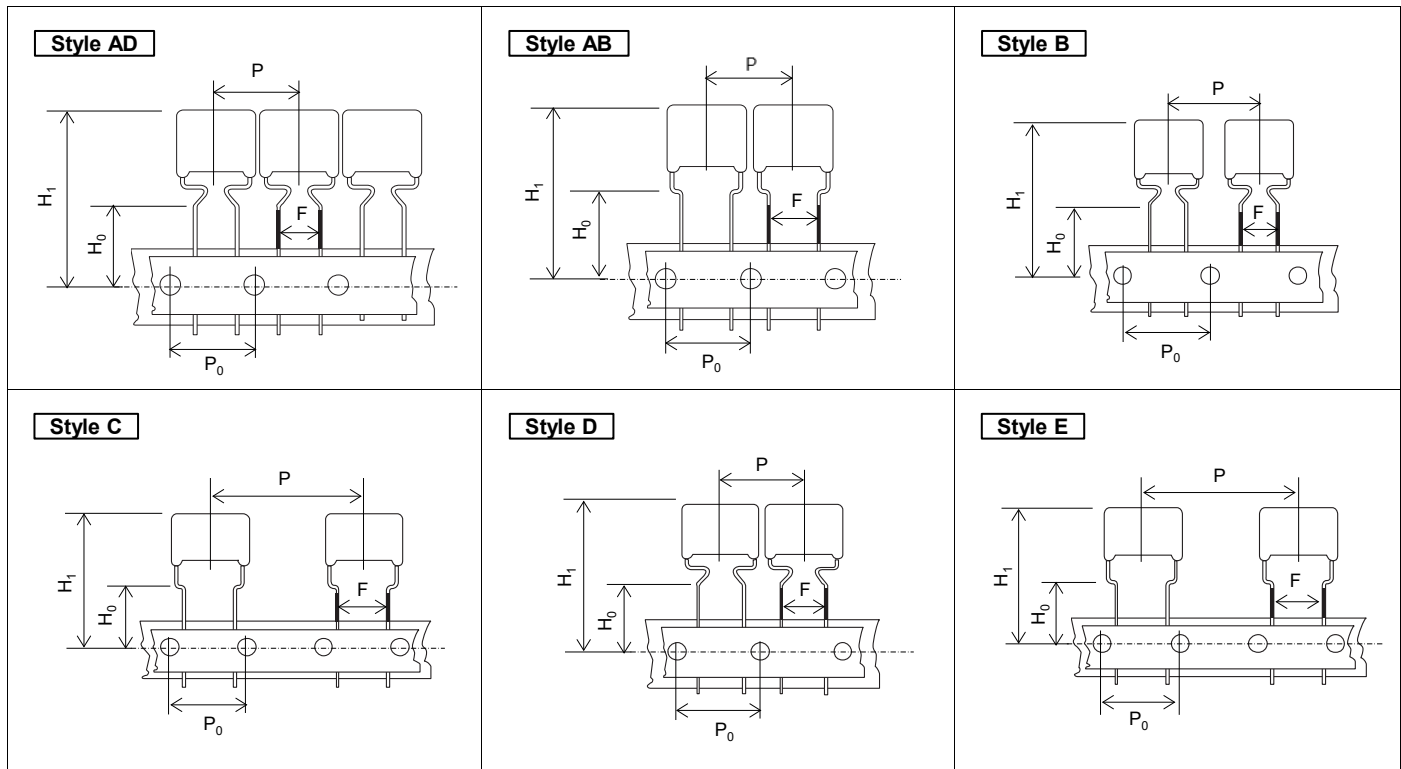

* Please check the product drawing for the shape of the lead wire forming.

The above diagram shows the taping dimensions, and the lead wire forming shape is an example.

* H₁ dimension is based on insertion machine "Panaset RH series" made by Panasonic. Consult with Panasonic technical staff when using other insertion machines.

Size list

Unit : mm

| | Style | | | | | |
|------------------|-------|------|------|------|------|------|
| | AD | AB | B | C | D | E |
| P | 12.7 | 12.7 | 15.0 | 25.4 | 15.0 | 30.0 |
| P ₀ | 12.7 | 12.7 | 15.0 | 12.7 | 15.0 | 15.0 |
| F | 5.0 | 5.0 | 5.0 | 5.0 | 7.5 | 7.5 |
| H ₀ | 16.0 | 16.0 | 16.0 | 16.0 | 16.0 | 16.0 |
| H ₁ * | 34.0 | 34.0 | 39.0 | 39.0 | 44.0 | 44.0 |

*max.

■ Packaging specifications

| Series | R.voltage | Capacitance range (μF) | Taping style | | | | | | | Packing | Suffix |
|-------------|-----------------|------------------------|--------------|----|---|---|---|------|--------|---------|--------|
| | | | AD | AB | B | C | D | E | | | |
| ECQE(F) | 100 V [DC] | 0.56 to 0.68 | ○ | | | | | | | Ammo | () F3 |
| | | 0.82 to 1.0 | | | ○ | | | | | Ammo | () F3 |
| | | 1.2 to 3.3 | | | | ○ | | | | Ammo | () F3 |
| | | 1.2 to 3.3 | | | | | | ○ | | Ammo | R() F |
| | 250 V [DC] | 0.010 to 0.27 | ○ | | | | | | | Ammo | () F3 |
| | | 0.33 | | | ○ | | | | | Ammo | () F3 |
| | | 0.39 to 1.5 | | | | ○ | | | | Ammo | () F3 |
| | | 0.010 to 0.33 | | | | | ○ | | | Ammo | R() F |
| | 400 V [DC] | 0.39 to 1.5 | | | | | | ○ | | Ammo | R() F |
| | | 0.010 to 0.10 | ○ | | | | | | | Ammo | () F3 |
| | | 0.12 to 0.47 | | | | ○ | | | | Ammo | () F3 |
| | | 0.010 to 0.10 | | | | | ○ | | | Ammo | R() F |
| | 630 V [DC] | 0.12 to 0.47 | | | | | | ○ | | Ammo | R() F |
| | | 0.0056 to 0.033 | ○ | | | | | | | Ammo | () F3 |
| | | 0.039 to 0.047 | | | ○ | | | | | Ammo | () F3 |
| | | 0.056 to 0.22 | | | | ○ | | | | Ammo | () F3 |
| 1000 V [DC] | 0.001 to 0.047 | | | | | ○ | | | Ammo | R() F | |
| | 0.056 to 0.22 | | | | | | ○ | | Ammo | R() F | |
| 1250 V [DC] | 0.010 to 0.10 | | | | | | ○ | Ammo | R() F | | |
| 125 V [AC] | 0.0033 to 0.022 | | | | | | ○ | | Ammo | R() F | |
| | 0.010 to 0.068 | | | ○ | | | | | Ammo | () F6 | |
| 250 V [AC] | 0.010 to 0.068 | | | | | ○ | | | Ammo | R() F | |
| | 0.010 to 0.033 | | | ○ | | | | | Ammo | () F6 | |
| | 0.010 to 0.047 | | | | | ○ | | | Ammo | R() F | |
| | 0.056 to 0.22 | | | | | | ○ | | Ammo | R() F | |

See the column "Rating · Dimensions · Quantity" for packaging quantity

● Lead spacing

| Style | Lead spacing |
|-------|--------------|
| AD | 5.0 |
| AB | 5.0 |
| B | 5.0 |
| C | 5.0 |
| D | 7.5 |
| E | 7.5 |

Unit : mm

Rating · Dimensions · Quantity

■ Rated voltage [DC] : 100 V, Capacitance tolerance : ±5 % (J), ±10 % (K)

| Part No. | Cap. (µF) | Dimensions (mm) | | | | | | | | Min. order Q'ty (PCS) | | | | |
|---------------|-----------|-----------------|--------|----------|--------------|----------|--------------|----------|-----------------|-----------------------|-----------------|-----------------|-----------------------|------|
| | | L max. | T max. | H max. | | F | | S | G max. | ød | Taping | | | Bulk |
| | | | | Straight | Crimped lead | Straight | Crimped lead | Straight | Standard 5.0 mm | | Odd size 5.0 mm | Odd size 7.5 mm | Straight-Crimped lead | |
| ECQE1564□F() | 0.56 | 12.0 | 5.5 | 10.9 | 15.9 | 10.0 | 10.0 | 1.0 | 0.6 | 500 | - | - | 500 | |
| ECQE1684□F() | 0.68 | 12.0 | 6.0 | 11.9 | 16.9 | 10.0 | 10.0 | 1.0 | 0.6 | | | | | |
| ECQE1824□F() | 0.82 | 12.0 | 6.0 | 13.5 | 18.5 | 10.0 | 10.0 | 1.0 | 0.6 | | | | | |
| ECQE1105□F() | 1.0 | 12.0 | 6.7 | 14.0 | 19.0 | 10.0 | 10.0 | 1.0 | 0.6 | | | | | |
| ECQE1125□F() | 1.2 | 18.5 | 5.5 | 12.8 | 17.8 | 15.0 | 10.0 | 1.0 | 0.6 | | | | | |
| ECQE1155□F() | 1.5 | 18.5 | 6.0 | 13.4 | 18.4 | 15.0 | 10.0 | 1.0 | 0.8 | | | | | |
| ECQE1185□F() | 1.8 | 18.5 | 6.5 | 14.4 | 19.4 | 15.0 | 10.0 | 1.0 | 0.8 | | | | | |
| ECQE1225□F() | 2.2 | 18.5 | 7.0 | 15.0 | 20.0 | 15.0 | 10.0 | 1.0 | 0.8 | | | | | |
| ECQE1275□F() | 2.7 | 18.5 | 8.0 | 15.8 | 20.8 | 15.0 | 10.0 | 1.0 | 0.8 | | | | | |
| ECQE1335□F() | 3.3 | 18.5 | 8.5 | 16.5 | 21.5 | 15.0 | 10.0 | 1.0 | 0.8 | | | | | |
| ECQE1395□F() | 3.9 | 26.0 | 7.0 | 16.4 | 21.4 | 22.5 | 15.0 | 1.0 | 0.8 | | | | | |
| ECQE1475□F() | 4.7 | 26.0 | 7.5 | 17.0 | 22.0 | 22.5 | 15.0 | 1.0 | 0.8 | | | | | |
| ECQE1565□F() | 5.6 | 26.0 | 8.3 | 17.5 | 22.5 | 22.5 | 15.0 | 1.0 | 0.8 | | | | | |
| ECQE1685□F() | 6.8 | 26.0 | 9.0 | 18.5 | 23.5 | 22.5 | 15.0 | 1.0 | 0.8 | | | | | |
| ECQE1825□F() | 8.2 | 26.0 | 10.0 | 20.0 | 25.0 | 22.5 | 15.0 | 1.5 | 0.8 | | | | | |
| ECQE1106□F() | 10.0 | 26.0 | 11.5 | 21.0 | 26.0 | 22.5 | 15.0 | 1.5 | 0.8 | | | | | |

* □ : Capacitance tolerance code
 () : Suffix for lead crimped or taped type

Type D : 0.56 µF to 1.0 µF
 Type B : 1.2 µF to 10.0 µF

■ Rated voltage [DC] : 250 V, Capacitance tolerance : ±5 % (J), ±10 % (K)

| Part No. | Cap. (µF) | Dimensions (mm) | | | | | | | | Min. order Q'ty (PCS) | | | | | |
|---------------|-----------|-----------------|--------|----------|--------------|----------|--------------|----------|-----------------|-----------------------|-----------------|-----------------|----------|--------------|--|
| | | L max. | T max. | H max. | | F | | S | G max. | ød | Taping | | | Bulk | |
| | | | | Straight | Crimped lead | Straight | Crimped lead | Straight | Standard 5.0 mm | | Odd size 5.0 mm | Odd size 7.5 mm | Straight | Crimped lead | |
| ECQE2103□F() | 0.010 | 10.3 | 4.3 | 7.4 | 12.4 | 7.5 | 7.5 | 1.0 | 0.6 | 1000 | - | 1000 | 500 | 500 | |
| ECQE2123□F() | 0.012 | 10.3 | 4.4 | 7.5 | 12.5 | 7.5 | 7.5 | 1.0 | 0.6 | | | | | | |
| ECQE2153□F() | 0.015 | 10.3 | 4.4 | 7.5 | 12.5 | 7.5 | 7.5 | 1.0 | 0.6 | | | | | | |
| ECQE2183□F() | 0.018 | 10.3 | 4.4 | 7.5 | 12.5 | 7.5 | 7.5 | 1.0 | 0.6 | | | | | | |
| ECQE2223□F() | 0.022 | 10.3 | 4.4 | 7.5 | 12.5 | 7.5 | 7.5 | 1.0 | 0.6 | | | | | | |
| ECQE2273□F() | 0.027 | 10.3 | 4.4 | 7.5 | 12.5 | 7.5 | 7.5 | 1.0 | 0.6 | | | | | | |
| ECQE2333□F() | 0.033 | 10.3 | 4.5 | 7.5 | 12.5 | 7.5 | 7.5 | 1.0 | 0.6 | | | | | | |
| ECQE2393□F() | 0.039 | 10.3 | 4.5 | 7.5 | 12.5 | 7.5 | 7.5 | 1.0 | 0.6 | | | | | | |
| ECQE2473□F() | 0.047 | 10.3 | 4.5 | 7.5 | 12.5 | 7.5 | 7.5 | 1.0 | 0.6 | | | | | | |
| ECQE2563□F() | 0.056 | 10.3 | 4.8 | 7.9 | 12.9 | 7.5 | 7.5 | 1.0 | 0.6 | | | | | | |
| ECQE2683□F() | 0.068 | 10.3 | 4.5 | 7.5 | 12.5 | 7.5 | 7.5 | 1.0 | 0.6 | | | | | | |
| ECQE2823□F() | 0.082 | 10.3 | 4.9 | 8.0 | 13.0 | 7.5 | 7.5 | 1.0 | 0.6 | | | | | | |
| ECQE2104□F() | 0.10 | 10.3 | 5.8 | 8.4 | 13.4 | 7.5 | 7.5 | 1.0 | 0.6 | | | | | | |
| ECQE2124□F() | 0.12 | 10.3 | 6.0 | 9.0 | 14.0 | 7.5 | 7.5 | 1.0 | 0.6 | | | | | | |
| ECQE2154□F() | 0.15 | 10.3 | 6.0 | 10.8 | 15.8 | 7.5 | 7.5 | 1.0 | 0.6 | | | | | | |
| ECQE2184□F() | 0.18 | 12.0 | 5.0 | 10.3 | 15.3 | 10.0 | 10.0 | 1.0 | 0.6 | | | | | | |
| ECQE2224□F() | 0.22 | 12.0 | 5.5 | 10.5 | 15.5 | 10.0 | 10.0 | 1.0 | 0.6 | | | | | | |
| ECQE2274□F() | 0.27 | 12.0 | 6.0 | 11.5 | 16.5 | 10.0 | 10.0 | 1.0 | 0.6 | | | | | | |
| ECQE2334□F() | 0.33 | 12.0 | 6.5 | 12.0 | 17.0 | 10.0 | 10.0 | 1.0 | 0.6 | | | | | | |
| ECQE2394□F() | 0.39 | 18.5 | 4.9 | 12.0 | 17.0 | 15.0 | 10.0 | 1.0 | 0.6 | | | | | | |
| ECQE2474□F() | 0.47 | 18.5 | 5.3 | 12.5 | 17.5 | 15.0 | 10.0 | 1.0 | 0.6 | | | | | | |
| ECQE2564□F() | 0.56 | 18.5 | 5.5 | 13.0 | 18.0 | 15.0 | 10.0 | 1.0 | 0.6 | | | | | | |
| ECQE2684□F() | 0.68 | 18.5 | 6.0 | 13.5 | 18.5 | 15.0 | 10.0 | 1.0 | 0.8 | | | | | | |
| ECQE2824□F() | 0.82 | 18.5 | 6.5 | 14.5 | 19.5 | 15.0 | 10.0 | 1.0 | 0.8 | | | | | | |
| ECQE2105□F() | 1.0 | 18.5 | 7.4 | 15.0 | 20.0 | 15.0 | 10.0 | 1.0 | 0.8 | | | | | | |
| ECQE2125□F() | 1.2 | 18.5 | 8.0 | 15.9 | 20.9 | 15.0 | 10.0 | 1.0 | 0.8 | | | | | | |
| ECQE2155□F() | 1.5 | 18.5 | 9.0 | 16.8 | 21.8 | 15.0 | 10.0 | 1.0 | 0.8 | | | | | | |
| ECQE2185□F() | 1.8 | 26.0 | 7.5 | 15.5 | 20.5 | 22.5 | 15.0 | 1.0 | 0.8 | | | | | | |
| ECQE2225□F() | 2.2 | 26.0 | 8.5 | 16.3 | 21.3 | 22.5 | 15.0 | 1.0 | 0.8 | | | | | | |
| ECQE2275□F() | 2.7 | 26.0 | 9.4 | 17.0 | 22.0 | 22.5 | 15.0 | 1.0 | 0.8 | | | | | | |
| ECQE2335□F() | 3.3 | 26.0 | 10.3 | 18.0 | 23.0 | 22.5 | 15.0 | 1.5 | 0.8 | | | | | | |
| ECQE2395 F() | 3.9 | 26.0 | 11.0 | 20.5 | 25.5 | 22.5 | 15.0 | 1.5 | 0.8 | | | | | | |
| ECQE2475□F() | 4.7 | 26.0 | 12.0 | 21.5 | 26.5 | 22.5 | 15.0 | 1.5 | 0.8 | | | | | | |
| ECQE2565□F() | 5.6 | 31.0 | 11.8 | 21.0 | 26.0 | 27.5 | 22.5 | 1.5 | 0.8 | | | | | | |
| ECQE2685□F() | 6.8 | 31.0 | 13.0 | 22.4 | 27.4 | 27.5 | 22.5 | 1.5 | 0.8 | | | | | | |
| ECQE2825□F() | 8.2 | 31.0 | 14.3 | 23.5 | 28.5 | 27.5 | 22.5 | 1.5 | 0.8 | | | | | | |
| ECQE2106□F() | 10.0 | 31.0 | 15.9 | 25.8 | 30.8 | 27.5 | 22.5 | 1.5 | 0.8 | | | | | | |

* □ : Capacitance tolerance code
 () : Suffix for lead crimped or taped type

Type D : 0.010 µF to 0.33 µF
 Type B : 0.39 µF to 10.0 µF

Rating · Dimensions · Quantity

■ Rated voltage [DC] : 400 V, Capacitance tolerance : ±5 %(J), ±10 %(K)

| Part No. | Cap. (μF) | Dimensions (mm) | | | | | | | | Min. order Q'ty (PCS) | | | | | |
|---------------|--------------|-----------------|-----------|----------|-----------------|----------|-----------------|----------|-----------------|-----------------------|-----|--------------------|--------------------|--------------------|--------------------------------------|
| | | L max. | T max. | H max. | | F | | S | | G max. Straight | ød | Taping | | | Bulk Straight- Crimped lead |
| | | | | Straight | Crimped lead | Straight | Crimped lead | Straight | Crimped lead | | | Standard 5.0 mm | Odd size 5.0 mm | Odd size 7.5 mm | |
| ECQE4103□F() | 0.010 | 10.3 | 4.3 | 7.4 | 12.4 | 7.5 | 7.5 | 1.0 | 0.6 | 1000 | - | 1000 | 500 | | |
| ECQE4123□F() | 0.012 | 10.3 | 4.4 | 7.5 | 12.5 | 7.5 | 7.5 | 1.0 | 0.6 | | | | | | |
| ECQE4153□F() | 0.015 | 10.3 | 4.4 | 7.5 | 12.5 | 7.5 | 7.5 | 1.0 | 0.6 | | | | | | |
| ECQE4183□F() | 0.018 | 10.3 | 4.4 | 7.5 | 12.5 | 7.5 | 7.5 | 1.0 | 0.6 | | | | | | |
| ECQE4223□F() | 0.022 | 10.3 | 4.8 | 7.9 | 12.9 | 7.5 | 7.5 | 1.0 | 0.6 | | | | | | |
| ECQE4273□F() | 0.027 | 10.3 | 5.5 | 8.0 | 13.0 | 7.5 | 7.5 | 1.0 | 0.6 | | | | | | |
| ECQE4333□F() | 0.033 | 10.3 | 6.0 | 9.0 | 14.0 | 7.5 | 7.5 | 1.0 | 0.6 | 500 | - | 1000 | | | |
| ECQE4393□F() | 0.039 | 12.0 | 4.9 | 8.0 | 13.0 | 10.0 | 10.0 | 1.0 | 0.6 | | | | | | |
| ECQE4473□F() | 0.047 | 12.0 | 5.0 | 8.3 | 13.3 | 10.0 | 10.0 | 1.0 | 0.6 | | | | | | |
| ECQE4563□F() | 0.056 | 12.0 | 5.0 | 10.0 | 15.0 | 10.0 | 10.0 | 1.0 | 0.6 | | | | | | |
| ECQE4683□F() | 0.068 | 12.0 | 5.4 | 10.5 | 15.5 | 10.0 | 10.0 | 1.0 | 0.6 | | | | | | |
| ECQE4823□F() | 0.082 | 12.0 | 5.8 | 11.0 | 16.0 | 10.0 | 10.0 | 1.0 | 0.6 | | | | | | |
| ECQE4104□F() | 0.10 | 12.0 | 6.3 | 12.0 | 17.0 | 10.0 | 10.0 | 1.0 | 0.6 | - | 500 | 500 | | | |
| ECQE4124□F() | 0.12 | 18.5 | 5.0 | 10.0 | 15.0 | 15.0 | 10.0 | 1.0 | 0.6 | | | | | | |
| ECQE4154□F() | 0.15 | 18.5 | 5.0 | 12.4 | 17.4 | 15.0 | 10.0 | 1.0 | 0.6 | | | | | | |
| ECQE4184□F() | 0.18 | 18.5 | 5.4 | 12.5 | 17.5 | 15.0 | 10.0 | 1.0 | 0.6 | | | | | | |
| ECQE4224□F() | 0.22 | 18.5 | 5.9 | 13.0 | 18.0 | 15.0 | 10.0 | 1.0 | 0.6 | | | | | | |
| ECQE4274□F() | 0.27 | 18.5 | 6.5 | 14.3 | 19.3 | 15.0 | 10.0 | 1.0 | 0.8 | | | | | | |
| ECQE4334□F() | 0.33 | 18.5 | 7.0 | 14.9 | 19.9 | 15.0 | 10.0 | 1.0 | 0.8 | | | | | | |
| ECQE4394□F() | 0.39 | 18.5 | 7.5 | 15.4 | 20.4 | 15.0 | 10.0 | 1.0 | 0.8 | | | | | | |
| ECQE4474□F() | 0.47 | 18.5 | 7.8 | 17.0 | 22.0 | 15.0 | 10.0 | 1.0 | 0.8 | | | | | | |
| ECQE4564□F() | 0.56 | 26.0 | 6.5 | 16.0 | 21.0 | 22.5 | 15.0 | 1.0 | 0.8 | | | | | | |
| ECQE4684□F() | 0.68 | 26.0 | 7.0 | 16.5 | 21.5 | 22.5 | 15.0 | 1.0 | 0.8 | | | | | | |
| ECQE4824□F() | 0.82 | 26.0 | 7.9 | 17.3 | 22.3 | 22.5 | 15.0 | 1.0 | 0.8 | | | | | | |
| ECQE4105□F() | 1.0 | 26.0 | 8.5 | 18.0 | 23.0 | 22.5 | 15.0 | 1.0 | 0.8 | - | - | - | | | |
| ECQE4125□F() | 1.2 | 26.0 | 9.5 | 18.9 | 23.9 | 22.5 | 15.0 | 1.0 | 0.8 | | | | | | |
| ECQE4155□F() | 1.5 | 31.0 | 9.5 | 19.0 | 24.0 | 27.5 | 22.5 | 1.0 | 0.8 | | | | | | |
| ECQE4185□F() | 1.8 | 31.0 | 11.0 | 20.5 | 25.5 | 27.5 | 22.5 | 1.5 | 0.8 | | | | | | |
| ECQE4225□F() | 2.2 | 31.0 | 11.0 | 22.0 | 27.0 | 27.5 | 22.5 | 1.5 | 0.8 | | | | | | |

* □ : Capacitance tolerance code
 () : Suffix for lead crimped or taped type

Type D : 0.010 μF to 0.10 μF
 Type B : 0.12 μF to 2.2 μF

Rating · Dimensions · Quantity

■ Rated voltage [DC] : 630 V, Capacitance tolerance : ±5 %(J), ±10 %(K)

| Part No. | Cap. (μF) | Dimensions (mm) | | | | | | | | Min. order Q'ty (PCS) | | | | |
|-------------------|--------------|-----------------|-----------|----------|-----------------|----------|-----------------|----------|-----|-----------------------|--------------------|--------------------|----------|-----------------|
| | | L max. | T max. | H max. | | F | S | G max. | ød | Taping | | | Bulk | |
| | | | | Straight | Crimped lead | Straight | Crimped lead | Straight | | Standard 5.0 mm | Odd size 5.0 mm | Odd size 7.5 mm | Straight | Crimped lead |
| EOL ECQE6102□F() | 0.0010 | 10.0 | 4.5 | 9.5 | 14.5 | 7.5 | 5.0 | 1.0 | 0.6 | 1000 | - | 1000 | 500 | 500 |
| EOL ECQE6122□F() | 0.0012 | 10.0 | 4.5 | 10.0 | 15.0 | 7.5 | 5.0 | 1.0 | 0.6 | | | | | |
| EOL ECQE6152□F() | 0.0015 | 10.0 | 4.5 | 10.0 | 15.0 | 7.5 | 5.0 | 1.0 | 0.6 | | | | | |
| EOL ECQE6182□F() | 0.0018 | 10.0 | 4.5 | 10.0 | 15.0 | 7.5 | 5.0 | 1.0 | 0.6 | | | | | |
| EOL ECQE6222□F() | 0.0022 | 10.0 | 4.5 | 10.0 | 15.0 | 7.5 | 5.0 | 1.0 | 0.6 | | | | | |
| EOL ECQE6272□F() | 0.0027 | 10.0 | 4.5 | 10.0 | 15.0 | 7.5 | 5.0 | 1.0 | 0.6 | | | | | |
| EOL ECQE6332□F() | 0.0033 | 10.0 | 4.5 | 10.0 | 15.0 | 7.5 | 5.0 | 1.0 | 0.6 | | | | | |
| EOL ECQE6392□F() | 0.0039 | 10.0 | 4.5 | 10.0 | 15.0 | 7.5 | 5.0 | 1.0 | 0.6 | | | | | |
| EOL ECQE6472□F() | 0.0047 | 12.0 | 4.5 | 10.0 | 15.0 | 10.0 | 7.5 | 1.0 | 0.6 | | | | | |
| ECQE6562□F() | 0.0056 | 12.0 | 4.5 | 10.0 | 15.0 | 10.0 | 7.5 | 1.0 | 0.6 | | | | | |
| ECQE6682□F() | 0.0068 | 12.0 | 4.9 | 10.0 | 15.0 | 10.0 | 7.5 | 1.0 | 0.6 | | | | | |
| ECQE6822□F() | 0.0082 | 12.0 | 4.5 | 10.0 | 15.0 | 10.0 | 7.5 | 1.0 | 0.6 | | | | | |
| ECQE6103□F() | 0.010 | 12.0 | 4.5 | 7.5 | 12.5 | 10.0 | 10.0 | 1.0 | 0.6 | | | | | |
| ECQE6123□F() | 0.012 | 12.0 | 4.5 | 7.8 | 12.8 | 10.0 | 10.0 | 1.0 | 0.6 | | | | | |
| ECQE6153□F() | 0.015 | 12.0 | 5.0 | 8.2 | 13.2 | 10.0 | 10.0 | 1.0 | 0.6 | | | | | |
| ECQE6183□F() | 0.018 | 12.0 | 4.9 | 10.0 | 15.0 | 10.0 | 10.0 | 1.0 | 0.6 | | | | | |
| ECQE6223□F() | 0.022 | 12.0 | 5.3 | 10.5 | 15.5 | 10.0 | 10.0 | 1.0 | 0.6 | | | | | |
| ECQE6273□F() | 0.027 | 12.0 | 5.5 | 10.9 | 15.9 | 10.0 | 10.0 | 1.0 | 0.6 | | | | | |
| ECQE6333□F() | 0.033 | 12.0 | 6.0 | 11.9 | 16.9 | 10.0 | 10.0 | 1.0 | 0.6 | | | | | |
| ECQE6393□F() | 0.039 | 12.0 | 6.0 | 13.4 | 18.4 | 10.0 | 10.0 | 1.0 | 0.6 | | | | | |
| ECQE6473□F() | 0.047 | 12.0 | 6.5 | 13.5 | 18.5 | 10.0 | 10.0 | 1.0 | 0.6 | | | | | |
| ECQE6563□F() | 0.056 | 18.5 | 5.4 | 10.5 | 15.5 | 15.0 | 10.0 | 1.0 | 0.6 | | | | | |
| ECQE6683□F() | 0.068 | 18.5 | 5.8 | 11.0 | 16.0 | 15.0 | 10.0 | 1.0 | 0.6 | | | | | |
| ECQE6823□F() | 0.082 | 18.5 | 6.5 | 12.0 | 17.0 | 15.0 | 10.0 | 1.0 | 0.6 | | | | | |
| ECQE6104□F() | 0.10 | 18.5 | 6.3 | 14.0 | 19.0 | 15.0 | 10.0 | 1.0 | 0.6 | | | | | |
| ECQE6124□F() | 0.12 | 18.5 | 6.3 | 14.5 | 19.5 | 15.0 | 10.0 | 1.0 | 0.8 | | | | | |
| ECQE6154□F() | 0.15 | 18.5 | 7.5 | 15.4 | 20.4 | 15.0 | 10.0 | 1.0 | 0.8 | | | | | |
| ECQE6184□F() | 0.18 | 18.5 | 8.0 | 16.0 | 21.0 | 15.0 | 10.0 | 1.0 | 0.8 | | | | | |
| ECQE6224□F() | 0.22 | 18.5 | 9.0 | 16.5 | 21.5 | 15.0 | 10.0 | 1.0 | 0.8 | | | | | |
| ECQE6274□F() | 0.27 | 26.0 | 7.0 | 16.5 | 21.5 | 22.5 | 15.0 | 1.0 | 0.8 | | | | | |
| ECQE6334□F() | 0.33 | 26.0 | 7.8 | 17.0 | 22.0 | 22.5 | 15.0 | 1.0 | 0.8 | | | | | |
| ECQE6394□F() | 0.39 | 26.0 | 8.5 | 17.9 | 22.9 | 22.5 | 15.0 | 1.0 | 0.8 | | | | | |
| ECQE6474□F() | 0.47 | 26.0 | 9.3 | 18.5 | 23.5 | 22.5 | 15.0 | 1.0 | 0.8 | | | | | |
| ECQE6564□F() | 0.56 | 26.0 | 10.0 | 20.0 | 25.0 | 22.5 | 15.0 | 1.5 | 0.8 | | | | | |
| ECQE6684□F() | 0.68 | 26.0 | 11.5 | 21.0 | 26.0 | 22.5 | 15.0 | 1.5 | 0.8 | | | | | |
| ECQE6824□F() | 0.82 | 31.0 | 11.3 | 20.5 | 25.5 | 27.5 | 22.5 | 1.5 | 0.8 | | | | | |
| ECQE6105□F() | 1.0 | 31.0 | 12.5 | 21.9 | 26.9 | 27.5 | 22.5 | 1.5 | 0.8 | | | | | |
| ECQE6125□F() | 1.2 | 31.0 | 13.5 | 23.0 | 28.0 | 27.5 | 22.5 | 1.5 | 0.8 | | | | | |
| ECQE6155□F() | 1.5 | 31.0 | 15.3 | 24.7 | 29.7 | 27.5 | 22.5 | 1.5 | 0.8 | | | | | |
| ECQE6185□F() | 1.8 | 31.0 | 16.8 | 27.0 | 32.0 | 27.5 | 22.5 | 1.5 | 0.8 | | | | | |
| ECQE6225□F() | 2.2 | 31.0 | 19.5 | 29.0 | 34.0 | 27.5 | 22.5 | 1.5 | 0.8 | | | | | |

* □ : Capacitance tolerance code
 () : Suffix for lead crimped or taped type

Type D : 0.010 μF to 0.047 μF
 Type B : 0.0056 μF to 0.0082 μF, 0.056 μF to 2.2 μF

Rating · Dimensions · Quantity

■ Rated voltage [DC] : 1000 V, 125 V [AC]*1, Capacitance tolerance : ±5 %(J), ±10 %(K)

| Part No. | Cap. (μF) | Dimensions (mm) | | | | | | | | Min. order Q'ty (PCS) | |
|----------------|-----------|-----------------|--------|----------|--------------|------|------|--------|-----|-----------------------|--------------|
| | | L max. | T max. | H max. | | F | S | G max. | ød | Taping | Bulk |
| | | | | Straight | Crimped lead | | | | | Straight | Crimped lead |
| ECQE10103□F() | 0.010 | 15.5 | 6.0 | 11.0 | 16.0 | 12.5 | 12.5 | 1.0 | 0.6 | 500 | 500 |
| ECQE10123□F() | 0.012 | 15.5 | 6.0 | 12.0 | 17.0 | 12.5 | 12.5 | 1.0 | 0.6 | | |
| ECQE10153□F() | 0.015 | 15.5 | 7.0 | 12.5 | 17.5 | 12.5 | 12.5 | 1.0 | 0.6 | | |
| ECQE10183□F() | 0.018 | 15.5 | 7.5 | 13.0 | 20.0 | 12.5 | 12.5 | 1.0 | 0.8 | 400 | |
| ECQE10223□F() | 0.022 | 15.5 | 7.5 | 15.5 | 22.5 | 12.5 | 12.5 | 1.0 | 0.8 | | |
| ECQE10273□F() | 0.027 | 21.0 | 6.0 | 13.0 | 18.0 | 17.5 | 12.5 | 1.0 | 0.8 | 500 | |
| ECQE10333□F() | 0.033 | 21.0 | 6.5 | 14.0 | 19.0 | 17.5 | 12.5 | 1.0 | 0.8 | | |
| ECQE10393□F() | 0.039 | 21.0 | 7.0 | 14.5 | 19.5 | 17.5 | 12.5 | 1.0 | 0.8 | 400 | |
| ECQE10473□F() | 0.047 | 21.0 | 7.5 | 15.5 | 20.5 | 17.5 | 12.5 | 1.0 | 0.8 | | |
| ECQE10563□F() | 0.056 | 21.0 | 7.5 | 17.0 | 22.0 | 17.5 | 12.5 | 1.0 | 0.8 | | |
| ECQE10683□F() | 0.068 | 21.0 | 8.5 | 18.0 | 23.0 | 17.5 | 12.5 | 1.0 | 0.8 | 300 | |
| ECQE10823□F() | 0.082 | 21.0 | 9.0 | 18.5 | 23.5 | 17.5 | 12.5 | 1.0 | 0.8 | | |
| ECQE10104□F() | 0.10 | 21.0 | 10.0 | 20.0 | 25.0 | 17.5 | 12.5 | 1.0 | 0.8 | - | |
| ECQE10124□F() | 0.12 | 26.0 | 9.0 | 18.5 | 23.5 | 22.5 | 17.5 | 1.0 | 0.8 | | |
| ECQE10154□F() | 0.15 | 26.0 | 10.0 | 20.0 | 25.0 | 22.5 | 17.5 | 1.5 | 0.8 | | |
| ECQE10184□F() | 0.18 | 26.0 | 10.5 | 22.0 | 27.0 | 22.5 | 17.5 | 1.5 | 0.8 | | |
| ECQE10224□F() | 0.22 | 26.0 | 12.0 | 23.0 | 28.0 | 22.5 | 17.5 | 1.5 | 0.8 | | |

* □ : Capacitance tolerance code
 () : Suffix for lead crimped or taped type

Type D : 0.010 μF to 0.022 μF
 Type B : 0.027 μF to 0.22 μF

*1 : This type has two rated voltage, one is DC rated voltage another is AC rated voltage.
 DC rated voltage is 1000 V [DC], AC rated voltage is 125 V [AC].
 Making for rated voltage is "1000 V, 125 V~"

When capacitors use in secondary side of power source, and in case of applying voltage in altering current (50 Hz or 60 Hz sine wave) to a capacitor, please refer to the page of "Permissible voltage (R.M.S) in altering current corresponding to DC rated voltage".

When capacitors use in primary side of power source, the rated voltage is shown 125 V [AC]. Voltage to be applied to capacitors in only sine wave (50 Hz or 60 Hz).

AC rated capacitors complying with clause 1 of "Electrical Appliance and Material Safety Law". And not complying with clause 2 of "Electrical Appliance and Material Safety Law", in this case please use ECQUA type or ECQUL type.

Rating · Dimensions · Quantity

■ Rated voltage [DC] : 1250 V、125 V [AC]*1, Capacitance tolerance : ±5 %(J), ±10 %(K)

| Part No. | Cap. (μF) | Dimensions (mm) | | | | | | | | Min. order Q'ty (PCS) | | | | |
|---------------------------|--------------|-----------------|-----------|----------|-----------------|----------|-----------------|----------|----------|-----------------------|-----|----------|-----------------|--|
| | | L max. | T max. | H max. | | F | | S | | G max. | ød | Taping | Bulk | |
| | | | | Straight | Crimped lead | Straight | Crimped lead | Straight | Straight | Odd size 7.5 mm | | Straight | Crimped lead | |
| EOL ECQE12102□F() | 0.0010 | 15.5 | 6.0 | 11.0 | 16.0 | 12.5 | 10.0 | 1.0 | 0.6 | 500 | 500 | 500 | | |
| EOL ECQE12122□F() | 0.0012 | 15.5 | 6.0 | 11.0 | 16.0 | 12.5 | 10.0 | 1.0 | 0.6 | | | | | |
| EOL ECQE12152□F() | 0.0015 | 15.5 | 6.0 | 11.0 | 16.0 | 12.5 | 10.0 | 1.0 | 0.6 | | | | | |
| EOL ECQE12182□F() | 0.0018 | 15.5 | 6.0 | 11.0 | 16.0 | 12.5 | 10.0 | 1.0 | 0.6 | | | | | |
| EOL ECQE12222□F() | 0.0022 | 15.5 | 6.0 | 11.5 | 16.5 | 12.5 | 10.0 | 1.0 | 0.6 | | | | | |
| EOL ECQE12272□F() | 0.0027 | 15.5 | 6.5 | 12.0 | 17.0 | 12.5 | 10.0 | 1.0 | 0.6 | | | | | |
| ECQE12332□F() | 0.0033 | 15.5 | 6.0 | 11.5 | 16.5 | 12.5 | 10.0 | 1.0 | 0.6 | 400 | 500 | 500 | | |
| ECQE12392□F() | 0.0039 | 15.5 | 6.5 | 12.0 | 17.0 | 12.5 | 10.0 | 1.0 | 0.6 | | | | | |
| ECQE12472□F() | 0.0047 | 15.5 | 7.0 | 12.5 | 17.5 | 12.5 | 10.0 | 1.0 | 0.6 | | | | | |
| ECQE12562□F() | 0.0056 | 15.5 | 7.5 | 13.0 | 18.0 | 12.5 | 10.0 | 1.0 | 0.6 | 500 | 500 | 500 | | |
| ECQE12682□F() | 0.0068 | 15.5 | 7.5 | 15.0 | 20.0 | 12.5 | 10.0 | 1.0 | 0.6 | | | | | |
| ECQE12822□F() | 0.0082 | 21.0 | 5.0 | 12.0 | 17.0 | 17.5 | 12.5 | 1.0 | 0.6 | | | | | |
| ECQE12103□F() | 0.010 | 21.0 | 5.0 | 12.5 | 17.5 | 17.5 | 12.5 | 1.0 | 0.6 | 500 | 500 | 500 | | |
| ECQE12123□F() | 0.012 | 21.0 | 5.5 | 13.0 | 18.0 | 17.5 | 12.5 | 1.0 | 0.6 | | | | | |
| ECQE12153□F() | 0.015 | 21.0 | 6.0 | 13.5 | 18.5 | 17.5 | 12.5 | 1.0 | 0.6 | | | | | |
| ECQE12183□F() | 0.018 | 21.0 | 6.5 | 14.5 | 19.5 | 17.5 | 12.5 | 1.0 | 0.8 | - | - | - | | |
| ECQE12223□F() | 0.022 | 21.0 | 7.0 | 15.0 | 20.0 | 17.5 | 12.5 | 1.0 | 0.8 | | | | | |
| ECQE12273□F() | 0.027 | 26.0 | 6.0 | 15.5 | 20.5 | 22.5 | 17.5 | 1.0 | 0.8 | | | | | |
| ECQE12333□F() | 0.033 | 26.0 | 6.5 | 16.0 | 21.0 | 22.5 | 17.5 | 1.0 | 0.8 | - | - | - | | |
| ECQE12393□F() | 0.039 | 26.0 | 7.0 | 16.5 | 21.5 | 22.5 | 17.5 | 1.0 | 0.8 | | | | | |
| ECQE12473□F() | 0.047 | 26.0 | 8.0 | 17.0 | 22.0 | 22.5 | 17.5 | 1.0 | 0.8 | | | | | |
| ECQE12563□F() | 0.056 | 31.0 | 7.5 | 17.0 | 22.0 | 27.5 | 22.5 | 1.0 | 0.8 | | | | | |
| ECQE12683□F() | 0.068 | 31.0 | 8.0 | 17.5 | 22.5 | 27.5 | 22.5 | 1.0 | 0.8 | | | | | |
| ECQE12823□F() | 0.082 | 31.0 | 9.0 | 18.5 | 23.5 | 27.5 | 22.5 | 1.0 | 0.8 | | | | | |
| ECQE12104□F() | 0.10 | 31.0 | 10.0 | 19.5 | 24.5 | 27.5 | 22.5 | 1.0 | 0.8 | | | | | |
| ECQE12124□F() | 0.12 | 31.0 | 11.5 | 20.5 | 25.5 | 27.5 | 22.5 | 1.5 | 0.8 | | | | | |
| ECQE12154□F() | 0.15 | 31.0 | 12.0 | 23.0 | 28.0 | 27.5 | 22.5 | 1.5 | 0.8 | | | | | |
| ECQE12184□F() | 0.18 | 31.0 | 13.0 | 24.5 | 29.5 | 27.5 | 22.5 | 1.5 | 0.8 | | | | | |
| ECQE12224□F() | 0.22 | 31.0 | 14.5 | 26.5 | 31.5 | 27.5 | 22.5 | 1.5 | 0.8 | 400 | | | | |

* □ : Capacitance tolerance code
 () : Suffix for lead crimped or taped type

Type D : 0.0033 μF to 0.0068 μF
 Type B : 0.0082 μF to 0.22 μF

*1 : This type has two rated voltage, one is DC rated voltage another is AC rated voltage.
 DC rated voltage is 1250 V [DC], AC rated voltage is 125 V [AC].
 Making for rated voltage is "1250 V, 125 V~"

When capacitors use in secondary side of power source, and in case of applying voltage in altering current (50 Hz or 60 Hz sine wave) to a capacitor, please refer to the page of "Permissible voltage (R.M.S) in altering current corresponding to DC rated voltage".

When capacitors use in primary side of power source, the rated voltage is shown 125 V [AC]. Voltage to be applied to capacitors in only sine wave (50 Hz or 60 Hz).

AC rated capacitors complying with clause 1 of "Electrical Appliance and Material Safety Law". And not complying with clause 2 of "Electrical Appliance and Material Safety Law", in this case please use ECQUA type or ECQUL type.

Rating · Dimensions · Quantity

- Rated voltage [AC] : 125 V, Capacitance tolerance : ±5 %(J), ±10 %(K)
Noise suppression Capacitors (Across-the-line)

| Part No. | Cap. (μF) | Dimensions (mm) | | | | | | | | Min. order Q'ty (PCS) | | | | | |
|----------------|-----------|-----------------|--------|----------|--------------|----------|--------------|----------|--------------|-----------------------|----|-----------------|-----------------|-----------------|------|
| | | L max. | T max. | H max. | | F | | S | | G max. | ød | Taping | | | Bulk |
| | | | | Straight | Crimped lead | Straight | Crimped lead | Straight | Crimped lead | | | Standard 5.0 mm | Odd size 5.0 mm | Odd size 7.5 mm | |
| ECQE1A103□F() | 0.010 | 10.5 | 4.5 | 7.5 | 12.5 | 7.5 | 7.5 | 1.0 | 0.6 | 1000 | - | 1000 | 500 | | |
| ECQE1A123□F() | 0.012 | 10.5 | 4.4 | 7.5 | 12.5 | 7.5 | 7.5 | 1.0 | 0.6 | | | | | | |
| ECQE1A153□F() | 0.015 | 10.5 | 4.4 | 7.5 | 12.5 | 7.5 | 7.5 | 1.0 | 0.6 | | | | | | |
| ECQE1A183□F() | 0.018 | 10.5 | 4.4 | 7.5 | 12.5 | 7.5 | 7.5 | 1.0 | 0.6 | | | | | | |
| ECQE1A223□F() | 0.022 | 10.5 | 4.4 | 7.5 | 12.5 | 7.5 | 7.5 | 1.0 | 0.6 | | | | | | |
| ECQE1A273□F() | 0.027 | 10.5 | 4.4 | 7.5 | 12.5 | 7.5 | 7.5 | 1.0 | 0.6 | | | | | | |
| ECQE1A333□F() | 0.033 | 10.5 | 4.5 | 7.8 | 12.8 | 7.5 | 7.5 | 1.0 | 0.6 | | | | | | |
| ECQE1A393□F() | 0.039 | 10.5 | 4.5 | 7.8 | 12.8 | 7.5 | 7.5 | 1.0 | 0.6 | | | | | | |
| ECQE1A473□F() | 0.047 | 10.5 | 5.5 | 8.0 | 13.0 | 7.5 | 7.5 | 1.0 | 0.6 | 500 | | | | | |
| ECQE1A563□F() | 0.056 | 10.5 | 5.9 | 8.5 | 13.5 | 7.5 | 7.5 | 1.0 | 0.6 | | | | | | |
| ECQE1A683□F() | 0.068 | 10.5 | 6.3 | 9.4 | 14.4 | 7.5 | 7.5 | 1.0 | 0.6 | | | | | | |

* □ : Capacitance tolerance code
() : Suffix for lead crimped or taped type

Type D : 0.010 μF to 0.068 μF

Notice for AC rated

AC rated capacitors complying with clause 1 of "Electrical Appliance and Material Safety Law".

As for clause 2 of "Electrical Appliance and Material Safety Law", please use ECQUA type or ECQUL type.

When using these capacitors as a across-the-line capacitor, it shall be required to follow either item 1. or item 2. condition.

1. Capacitor shall be connected in parallel with varistor (Specified varistor voltage in table 1.)
2. Voltage applied for capacitor shall not exceed other than specified in table 1, when using these capacitors

Table 1

| Capacitor rated voltage | Varistor voltage | Pulse voltage |
|-------------------------|------------------|----------------------|
| 125 V [AC] | 250 V | 250 V _{0-p} |

Rating · Dimensions · Quantity

- Rated voltage [AC] : 250 V, Capacitance tolerance : ±5 %(J), ±10 %(K)
Noise suppression Capacitors (Across-the-line)

| Part No. | Cap. (μF) | Dimensions (mm) | | | | | | | | Min. order Q'ty (PCS) | | | | |
|------------------|-----------|-----------------|--------|----------|--------------|----------|--------------|----------|-----------------|-----------------------|-----------------|-----------------|-----|---------------------------------|
| | | L max. | T max. | H max. | | F | | S | G max. | ød | Taping | | | Bulk Straight · Crimped lead |
| | | | | Straight | Crimped lead | Straight | Crimped lead | Straight | Standard 5.0 mm | | Odd size 5.0 mm | Odd size 7.5 mm | | |
| ECQE2A103□F() | 0.010 | 12.5 | 5.5 | 10.8 | 15.8 | 10.0 | 10.0 | 1.0 | 0.6 | 500 | 1000 | 500 | 500 | |
| ECQE2A123□F() | 0.012 | 12.5 | 6.0 | 11.5 | 16.5 | 10.0 | 10.0 | 1.0 | 0.6 | | | | | |
| ECQE2A153□F() | 0.015 | 12.5 | 6.3 | 9.9 | 14.9 | 10.0 | 10.0 | 1.0 | 0.6 | | | | | |
| ECQE2A183□F() | 0.018 | 12.5 | 6.0 | 11.9 | 16.9 | 10.0 | 10.0 | 1.0 | 0.6 | | | | | |
| ECQE2A223□F() | 0.022 | 12.5 | 6.0 | 11.5 | 16.5 | 10.0 | 10.0 | 1.0 | 0.6 | | | | | |
| ECQE2A273□F() | 0.027 | 12.5 | 5.5 | 10.9 | 15.9 | 10.0 | 10.0 | 1.0 | 0.6 | | | | | |
| ECQE2A333□F() | 0.033 | 12.5 | 6.0 | 11.9 | 16.9 | 10.0 | 10.0 | 1.0 | 0.6 | | | | | |
| ECQE2A393□F() | 0.039 | 12.5 | 6.0 | 13.4 | 18.4 | 10.0 | 10.0 | 1.0 | 0.6 | | | | | |
| ECQE2A473□F() | 0.047 | 12.5 | 6.5 | 14.4 | 19.4 | 10.0 | 10.0 | 1.0 | 0.6 | | | | | |
| ECQE2A563□F() | 0.056 | 18.5 | 5.4 | 10.5 | 15.5 | 15.0 | 10.0 | 1.0 | 0.6 | | | | | |
| ECQE2A683□F() | 0.068 | 18.5 | 5.8 | 11.0 | 16.0 | 15.0 | 10.0 | 1.0 | 0.6 | | | | | |
| ECQE2A823□F() | 0.082 | 18.5 | 6.3 | 12.0 | 17.0 | 15.0 | 10.0 | 1.0 | 0.6 | | | | | |
| ECQE2A104□F() | 0.10 | 18.5 | 6.3 | 14.0 | 19.0 | 15.0 | 10.0 | 1.0 | 0.6 | | | | | |
| ECQE2A124□F() | 0.12 | 18.5 | 6.8 | 14.5 | 19.5 | 15.0 | 10.0 | 1.0 | 0.8 | | | | | |
| ECQE2A154□F() | 0.15 | 18.5 | 7.5 | 15.4 | 20.4 | 15.0 | 10.0 | 1.0 | 0.8 | | | | | |
| ECQE2A184□F() | 0.18 | 18.5 | 8.0 | 16.0 | 21.0 | 15.0 | 10.0 | 1.0 | 0.8 | | | | | |
| ECQE2A224□F() | 0.22 | 18.5 | 9.0 | 16.9 | 21.9 | 15.0 | 10.0 | 1.0 | 0.8 | | | | | |
| ECQE2A274□F() | 0.27 | 26.0 | 7.0 | 16.5 | 21.5 | 22.5 | 15.0 | 1.0 | 0.8 | | | | | |
| ECQE2A334□F() | 0.33 | 26.0 | 7.8 | 17.0 | 22.0 | 22.5 | 15.0 | 1.0 | 0.8 | | | | | |
| ECQE2A394□F() | 0.39 | 26.0 | 8.5 | 17.9 | 22.9 | 22.5 | 15.0 | 1.0 | 0.8 | | | | | |
| ECQE2A474□F() | 0.47 | 26.0 | 9.3 | 18.5 | 23.5 | 22.5 | 15.0 | 1.0 | 0.8 | | | | | |
| ECQE2A564P()() | 0.56 | 26.0 | 10.0 | 20.0 | — | 22.5 | — | 1.0 | 0.8 | | | | | |
| ECQE2A684P()() | 0.68 | 26.0 | 11.5 | 21.0 | — | 22.5 | — | 1.0 | 0.8 | | | | | |
| ECQE2A824P()() | 0.82 | 26.0 | 13.0 | 22.5 | — | 22.5 | — | 1.0 | 0.8 | | | | | |
| ECQE2A105P()() | 1.0 | 31.0 | 12.5 | 21.9 | — | 27.5 | — | 1.5 | 0.8 | | | | | |
| ECQE2A125P()() | 1.2 | 31.0 | 13.5 | 23.0 | — | 27.5 | — | 1.5 | 0.8 | | | | | |
| ECQE2A155P()() | 1.5 | 31.0 | 15.3 | 24.7 | — | 27.5 | — | 1.5 | 0.8 | | | | | |
| ECQE2A185P()() | 1.8 | 31.0 | 16.8 | 27.0 | — | 27.5 | — | 1.5 | 0.8 | | | | | |
| ECQE2A225P()() | 2.2 | 31.0 | 19.5 | 29.0 | — | 27.5 | — | 1.5 | 0.8 | | | | | |

* □ : Capacitance tolerance code

() : Suffix for lead crimped or taped type

P() : Please contact us about special part number.

* Please consult us about Crimped lead type of 0.56 μF to 2.2 μF.

Type D : 0.010 μF ~ 0.047 μF

Type B : 0.056 μF ~ 0.47 μF

Notice for AC rated

AC rated capacitors complying with clause 1 of “Electrical Appliance and Material Safety Law”.

As for clause 2 of “Electrical Appliance and Material Safety Law”, please use ECQUA type or ECQUL type.

When using these capacitors as a across-the-line capacitor, it shall be required to follow either item 1. or item 2. condition.

1. Capacitor shall be connected in parallel with varistor (Specified varistor voltage in table 1.)
2. Voltage applied for capacitor shall not exceed other than specified in table 1, when using these capacitors

Table 1

| Capacitor rated voltage | Varistor voltage | Pulse voltage |
|-------------------------|------------------|----------------------|
| 250 V [AC] | 470 V | 630 V _{0-p} |

Safety and Legal Matters to Be Observed

Product specifications and applications

- Please be advised that this product and product specifications are subject to change without notice for improvement purposes. Therefore, please request and confirm the latest delivery specifications that explain the specifications in detail before the final design, or purchase or use of the product, regardless of the application. In addition, do not use this product in any way that deviates from the contents of the company's delivery specifications.
- Unless otherwise specified in this catalog or the product specifications, this product is intended for use in general electronic equipment (AV products, home appliances, commercial equipment, office equipment, information and communication equipment, etc.).
When this product is used for the following special cases, the specification document suited to each application shall be signed/sealed (with Panasonic Industry and the user) in advance..These include applications requiring special quality and reliability, wherein their failures or malfunctions may directly threaten human life or cause harm to the human body (e.g.: space/aircraft equipment, transportation/traffic equipment, combustion equipment, medical equipment, disaster prevention/crime prevention equipment, safety equipment, etc.).

Safety design and product evaluation

- Please ensure safety through protection circuits, redundant circuits, etc., in the customer's system design so that a defect in our company's product will not endanger human life or cause other serious damage.
- This catalog shows the quality and performance of individual parts. The durability of parts varies depending on the usage environment and conditions. Therefore, please ensure to evaluate and confirm the state of each part after it has been mounted in your product in the actual operating environment before use.
If you have any doubts about the safety of this product, then please notify us immediately, and be sure to conduct a technical review including the above protection circuits and redundant circuits at your company.

Laws / Regulations / Intellectual property

- The transportation of dangerous goods as designated by UN numbers, UN classifications, etc., does not apply to this product. In addition, when exporting products, product specifications, and technical information described in this catalog, please comply with the laws and regulations of the countries to which the products are exported, especially those concerning security export control.
- Each model of this product complies with the RoHS Directive (Restriction of the use of hazardous substances in electrical and electronic equipment) (2011/65/EU and (EU) 2015/863). The date of compliance with the RoHS Directive and REACH Regulation varies depending on the product model.
Further, if you are using product models in stock and are not sure whether or not they comply with the RoHS Directive or REACH Regulation, please contact us by selecting "Sales Inquiry" from the inquiry form.
- During the manufacturing process of this product and any of its components and materials to be used, Panasonic Industry does not intentionally use ozone-depleting substances stipulated in the Montreal Protocol and specific bromine-based flame retardants such as PBBs (Poly-Brominated Biphenyls) / PBDEs (Poly-Brominated Diphenyl Ethers). In addition, the materials used in this product are all listed as existing chemical substances based on the Act on the Regulation of Manufacture and Evaluation of Chemical Substances.
- With regard to the disposal of this product, please confirm the disposal method in each country and region where it is incorporated into your company's product and used.
- The technical information contained in this catalog is intended to show only typical operation and application circuit examples of this product. This catalog does not guarantee that such information does not infringe upon the intellectual property rights of Panasonic Industry or any third party, nor imply that the license of such rights has been granted.
- Design, materials, or process related to technical owned by Panasonic Industry are subject to change without notice.

Panasonic Industry will assume no liability whatsoever if the use of our company's products deviates from the contents of this catalog or does not comply with the precautions. Please be advised of these restrictions.

Matters to Be Observed When Using This Product

(Film capacitor)

Use environments

- This product is intended for standard general-purpose use in electronic equipment, and is not designed for use in specific environments described below. Using the product in such specific environments or service conditions, therefore, may affect the performance of the product. Please check the performance and reliability of the product first before using the product.
 - (1) The product characteristics may deteriorate in environments where the product is exposed to water, oil, direct sunlight, ozone, UV-rays, radiant rays, etc. Do not use the product in these environments.
 - (2) High-humidity environment: When the capacitor is used in a high-humidity environment for a long period, moisture permeates its outer case reaching internal elements as time goes by.

This moisture oxidizes a film deposit or spraying of metal, thus causing the capacitor problems. As a result of moisture absorption, some types capacitors may have their capacitances increased.
 - (3) High temperature: There are cases where oil leaks from an ECQUG type capacitor used under high-temperature conditions (70°C or higher). However, it rarely happens and does not affect the quality and reliability of the capacitor at all. Nevertheless, avoid such a configuration in which the product and a component that may have a contact failure caused by oil are incorporated together in the same circuit set. If you have any question, please feel free to contact us.
 - (4) Gaseous atmosphere: Avoid using the capacitor in an oxidizing gas, such as a hydrogen chloride gas, hydrogen sulfide gas, and sulfurous acid gas. Using the capacitor in such a gaseous atmosphere results in oxidized film deposit (aluminum) or spraying of metal (zinc) that may cause an ignition or smoking incident.
 - (5) Resin coat: If you intend to coat the capacitor with a resin for the purpose of improving its resistance to moisture and gas or fixing a component, make separate inquiries to us about the matter.

A chemical solvent included in the resin permeates the metal sprayed parts or electrode (film deposit), which may cause the degradation of the capacitor characteristics. When curing resin, the resin generates chemical reaction heat (curing heat), which may have a negative influence on the capacitor.

When embedding the whole capacitor completely with a resin, sufficiently analyze/assess the effects of the thermomechanical stress created by thermal expansion/shrinkage.
 - (6) See to it that no dust gets deposited on the product. Dust deposition on the product causes current leakage, etc., leading to a degradation of the product characteristics.

Cleaning conditions

- The effects of cleaning processes on the capacitor vary widely, depending on its structure and materials. Generally speaking, the capacitor is hardly susceptible to a CFC-based solvent and an alcohol-based solvent but is affected by a solvent with high polarity in some cases. In many cases, the capacitor with leads is covered with an outer casing made of an epoxy resin highly resistant to chemicals and is therefore barely affected by a cleaner. We nevertheless advise you to clean the capacitor as quickly as possible. A chip-type laminated film capacitor (ECHU, ECWU, ECPU) is not protected with an outer jacket. During cleaning processes, solder flux or a cleaner deposited on an element of the capacitor, may be activated and flow into the capacitor, causing a problem.
- Ultrasonic cleaning may cause some problems, depending on the cleaner used and ultrasonic power output. Such problems include peeling of protective film, separation of an electrode due to resonance, and degraded capacitor characteristics. Make sufficient examinations/confirmations before carrying out ultrasonic cleaning.
- As a result of strict regulations on CFC-based and chlorine-based solvents, cleaners not containing such solvents have come into wide use. Some such alternative cleaners are, however, still harmful to the chip-type laminated film capacitor and could be harmful under improper cleaning conditions. Examine the cleaner sufficiently before using it. If you intend to use an alternative cleaner, please contact us in advance. Cleaning methods using an alternative cleaner include a method in which a high-pressure spray of cleaner (water) hits against the board.

In this case, the water pressure may cause the protective film to peel off from the element surface.

Research the cleaning method before executing it.
- Dry the cleaned capacitor sufficiently so that no cleaner remains thereon. An insufficient drying process allows the cleaner to remain on the element surface, in which case measurement of the insulation resistance of the capacitor may indicate an apparent drop in the insulation resistance.
- A recommended cleaner is isopropyl alcohol (IPA), which is a general industrial reagent. Recommended cleaning conditions include a cleaning temperature of 50°C and a cleaning time of 5 minutes or shorter, which apply equally to immersion cleaning, vapor cleaning, and ultrasonic cleaning.
- A list of cleaners that can be or cannot be used to clean the capacitor is shown on the next page. See the list for your reference. If you are not clear about whether or not a cleaner can be used to clean the capacitor, make sure to contact us.

<List of cleaners that can be or cannot be used to clean the capacitor>

| | | Cleaning conditions | Chip type | Lead type | Retail product* |
|---------------|---|--|-----------|-----------|-----------------|
| Solvent-based | Alcohol-based | Ethanol Ultrasonic cleaning or immersion cleaning for 5 minutes | ○ | ○ | ○ |
| | | Isopropyl alcohol (IPA) Ultrasonic cleaning or immersion cleaning for 5 minutes | ○ | ○ | ○ |
| | Silicon-based | FRW-17: ultrasonic cleaning at 60 °C for 5 minutes → FRW-1N: ultrasonic cleaning at 60 °C for 5 minutes → FRW-100: vapor drying at 100 °C for 1 minute | ○ | ○ | ○ |
| | Halogen-based | HCFC141b-MS Ultrasonic cleaning or immersion cleaning for 5 minutes | ○ | ○ | ○ |
| | Petroleum-based Hydrocarbon | P3 Cold Cleaner 225S Ultrasonic cleaning at 60 °C for 5 minutes → Ultrasonic rinsing with IPA at ordinary temperature for 5 minutes → Hot air drying at 40 °C for 5 minutes | ○ | ○ | ○ |
| | | Toluene Ultrasonic cleaning or immersion cleaning for 5 minutes | × | ○ | ○ |
| Terpene-based | Terpene Cleaner EC-7 Spray cleaning at ordinary temperature for 5 minutes → Spray rinsing with pure water at 50 °C for 5 minutes → Hot air drying at 80 °C for 5 minutes | × | ○ | ○ | |
| Water-based | Pure water | Ultrasonic cleaning at 60 °C for 5 minutes → Non-blow drying at 85 °C for 5 minutes | × | ○ | ○ |
| | Surfactant | Cleanthrough 750H Ultrasonic cleaning at 60 °C for 5 minutes → Ultrasonic rinsing with pure water at 60 °C for 5 minutes → Hot air drying at 85 °C for 5 minutes | × | ○ | ○ |
| | | Cleanthrough 750L Ultrasonic cleaning at 60 °C for 5 minutes → Ultrasonic rinsing with pure water at 60 °C for 5 minutes → Hot air drying at 85 °C for 5 minutes | × | ○ | — |
| | | | × | ○ | — |
| | | Cleanthrough LC-841 Ultrasonic cleaning at 60 °C for 5 minutes → Ultrasonic rinsing with pure water at 60 °C for 5 minutes → Hot air drying at 85 °C for 5 minutes | × | ○ | ○ |
| | | Pine Alpha ST-100S Ultrasonic cleaning at 60 °C for 5 minutes → Ultrasonic rinsing with pure water at 60 °C for 5 minutes → Hot air drying at 85 °C for 5 minutes | × | ○ | ○ |
| | | Aqua Cleaner 210SET Shower cleaning at 60 °C for 1 minute → Ultrasonic rinsing with pure water at 60 °C for 5 minutes → Hot air drying at 85 °C for 5 minutes | × | ○ | ○ |

* Retail product: ECWFE, ECWFG

<Uncleaned flux>

| | | | | | |
|-----------|------------------|-----------|---|---|---|
| Uncleaned | Low-residue flux | ULF-500VS | ○ | ○ | ○ |
| | Non-active flux | AM-173 | ○ | ○ | ○ |

○ cleaner can be used, × cleaner cannot be used, — unconfirmed

Response to anomalies and handling conditions

- A dielectric film is not a fire-resistant material. In contrast, an ECQE type metallized polyester capacitor and ECWF type/ ECWH type metallized polypropylene capacitors each have an outer casing made of a fire-resistant epoxy resin (UL94 V-0).
- Because the capacitor described herein is made of a combustible material, it may generate smoke or even ignite when exposed to excessive heat. We therefore recommend you cover the capacitor with a fire-resistant material or fire-resistant case. When you use the capacitor at an operating voltage of 30 V AC or higher or 45 V DC or higher, to prevent noise between a line and the ground or between different lines, we recommend you cover a resin component near the capacitor with a fire-resistant material or fire-resistant case (to prevent a fire accident).
- When a different component in the same circuit has short-circuited or developed an open failure, see to it that a voltage or current higher than the rated voltage or current or excessive heat is not applied to the capacitor.
We define the maximum voltage that can be applied consecutively regardless of temperature, as rated voltage^{*1}. Be careful with the fact, however, that this rated voltage is different from rated voltages defined in JIS, IEC, etc.^{*2}
 - *1 Definition of the rated voltage by our company
We define the maximum voltage that can be applied continuously within the entire category temperature range, as the rated voltage. In a high-temperature condition where voltage reduction is necessary, a reduced maximum voltage is referred to as the rated voltage. Therefore, the maximum voltage that can be applied continuously at the category upper limit temperature is also referred to as the rated voltage.
 - *2 Definition of the rated voltage by JIS and IEC
JIS and IEC define the maximum voltage that can be applied continuously within a temperature range from the category lower limit temperature to the rated temperature, as the rated voltage. According to JIS and IEC, the maximum voltage that can be applied continuously at the category upper limit temperature is referred to as the category voltage. In a temperature range from the rated temperature to the category upper limit temperature, voltage reduction is necessary in some cases, where a reduced maximum voltage is referred to as temperature-dependent reduced voltage.
- Current that charges or discharges from the capacitor in a rapid charge or discharge causes short-circuit failure, open failure, etc., thus leading to the degradation of the capacitor characteristics. Make sure that the capacitor is charged or discharges with a resistance of 20 Ω/V to 1000 Ω/V or more in series. In a withstand voltage test, service life test, etc., where numbers of the capacitors are connected in parallel, each capacitor must have a resistance of 20 Ω/V to 1000 Ω/V or more connected in series thereto.
- Make sure that a sharp element (a screw driver, solder iron, tweezers, a chassis edge, etc.) does not hit the capacitor surface.
Do not apply an unnecessarily heavy load to the leads (for example, by reworking the leads).
- Accidentally dropping the capacitor on the floor may damage its characteristics. Do not use a capacitor when this happens. If you still use such a dropped capacitor, check its quality first.
- Be careful not to apply excessive force to the base of the leads of a lead-type capacitor. It causes the exterior resin near the base to crack.
- The chip-type capacitor has been developed under the assumption that it will be used as an ordinary surface-mounted component. Avoid using a capacitor in an unusual configuration (e.g., stacking the capacitors in two layers, setting the capacitor in a standing position, etc.). When you intend to use the capacitor in an unusual configuration, please contact us in advance.
- Take care to prevent water or dust from adhering to the terminal surface of the capacitor. Water or dust on the terminal causes current leakage, corrosion, etc.
- The capacitor emits a humming sound created by mechanical vibration of the dielectric film caused by a coulomb force between the positive and negative electrodes. In particular, the humming sound, in the form of a sound wave containing a source voltage distortion or harmonic component, is heard as a high-tone sound.
From the viewpoint of electrical characteristics, it poses no problem. However, when the capacitor is used at a frequency close to the audible frequency, check the humming sound.
- When the capacitor is used as a capacitor for preventing noise from an AC power supply (across-the-line capacitor), a source voltage is constantly applied to the capacitor and a surge voltage, such as a lightning surge, is applied to the capacitor as well. This may cause the capacitor to ignite or generate smoke. For such capacitors inserted between power lines, strict safety standards are set by individual countries, using products conforming to the safety standards is mandatory. When you are looking for across-the-line capacitors for use in domestic equipment, use capacitors conforming to overseas certification standards or capacitors listed below.

ECQE(F) : Rating 1000 V DC (125 V AC)
ECQE(F) : Rating 1250 V DC (125 V AC)

ECQE(F)/(B)/(T) : Rating 125 V AC (1A)
ECQE(F)/(T) : Rating 250 V AC (2A)

- When ECQE(F)1A /2A, ECQE(B)1A, and ECQE(T)1A /2A are used as across-the-line capacitors, they must satisfy at least one of the following conditions.
 - (1) A varistor with a varistor voltage specified in the following table or lower is connected in parallel with the capacitor.
 - (2) No pulse voltage higher than the pulse voltage specified in the following table is applied across both ends of the capacitor.
- When using a varistor together with the capacitor, confirm the varistor with the delivery specification sheet and use a varistor with no sign of surge-caused deterioration.

| Capacitor rated voltage | Varistor voltage | Pulse voltage |
|-------------------------|------------------|---------------|
| 125 V.AC (1A) | 250 V | 250 Vo-p |
| 250 V.AC (2A) | 470 V | 630 Vo-p |

- When using the capacitor in equipment requiring capacitors conforming to overseas certification standards, use capacitors (typical types) listed in the following table. To know about CQC standards in China, make an inquiry with us.

| Shape | Type | Certification standards |
|------------|-------|---|
| Resin case | ECQUA | UL 60384-14(US), CSA E60384-14(CA), EN 60384-14(EU) |
| Resin case | ECQUL | UL 60384-14(US), CSA E60384-14(CA), EN 60384-14(EU) |
| Resin case | ECQUG | UL 60384-14(US), CSA E60384-14(CA), EN 60384-14(EU) |

- Using the capacitor as a voltage dropper may result in a reduction in the capacitance. For example, when an abnormal voltage, such as surge voltage, is applied to the capacitor, a fuse inside the capacitor is activated, which reduces its capacitance. In a worst-case scenario, the capacitor no longer functions as a voltage dropper. Observe the capacitor carefully to see if any abnormal voltage is applied thereto. Such abnormal voltage to the capacitor may generate high voltage applied to the circuit load. To deal with such a problem, provide the circuit with a safety protection means.

Reliability and product life

- Capacitor characteristics change, depending on ambient environment conditions under which the capacitor operates. Even when the capacitor is just left as it is, humidity in the air can infiltrate the capacitor and cause a slight change in its capacitance. An extent to which the capacitance changes in this situation varies depending on a dielectric material, an outer casing material, a structure, etc. We take these characteristics changes into consideration before shipping out the capacitor. However, unless a separate agreement is made, our guarantee for the specified capacitance value will be effective only up to the delivery date.
- When using a capacitor in a circuit that requires precise capacitor elements, such as time constant, use polypropylene-based capacitors with less time-dependent change, such as ECWFD, ECWF(A), ECWF(L), ECWH(A), PPS-based ECHU(X), and ECHU(C).
- A product conforming to "AEC-Q200" refers to a product having passed some or all of the evaluation test items defined in AEC-Q200. To know the detailed specifications of individual products or specific evaluation test scores, please contact us. We issue a delivery specification sheet for each product ordered. Please confirm with the sheet when you place an order with us.

Circuit design (working voltage)

- The maximum working voltage applicable to a capacitor varies, depending on the voltage waveform, current waveform, frequency, ambient temperature (surface temperature), capacitance, etc. When using a capacitor, check the voltage waveform and current waveform applied across both terminals of the capacitor and the operating frequency and make sure that these are within specified values. When the frequency is high, some product types take different allowable voltages. You can confirm detailed information about this matter on delivery specification sheets.
- The rated voltage is the maximum voltage that can be applied continuously within the category temperature range. Operating the capacitor with a voltage higher than the rated voltage leads to dielectric breakdown of the capacitor film, which may cause a short-circuit failure. Service lives of capacitors operating at the maximum rated voltages vary, depending on their types.
- When a voltage higher than the rated voltage is applied to the capacitor, it does not cause a short circuit failure immediately because of the self-recovery ability of the capacitor, however, a drop in the insulation resistance may occur, which can lead to smoke generation or ignition under certain circuit conditions.
- Do not use a noise-preventing capacitor (AC rated voltage type) in a high-frequency circuit. It may cause smoke generation or ignition under certain service conditions. Rated voltages of capacitors for electronic equipment, except that of a special types, are usually indicated as DC voltage.

■ The capacitor has an upper limit service temperature (surface temperature) determined in accordance with the type of a dielectric material making up the capacitor. When using the capacitor at a temperature higher than the rated temperature, confirm the following classification table because some types capacitors require voltage reduction. Even when the capacitor can be used at a temperature higher than the rated temperature, make sure that voltage reduction is carried out to keep the surface temperature equal to or lower than an upper limit service temperature specified in the following table.

A capacitor used at a high frequency shows a self-temperature rise. A voltage reduction rate shown in the following table, therefore, cannot be applied in this case.

The AC rated voltage type capacitor does not need a temperature-dependent voltage reduction.

<Rated temperatures, category upper limit temperatures, and voltage reduction rates classified by type in the case of DC working voltage>

| Dielectric material | Type | Rated temperature | Category upper limit temperature (maximum service temperature) | Rated voltage in a temperature range equal to or higher than the rated temperature (voltage reduction rate) |
|--------------------------------|---|-------------------|--|---|
| Polyester (PET) | ECQE(F) | 85 °C | 105 °C | 1.25%/ °C |
| | ECQE(B) | | | |
| | ECQE(T) | | | |
| Polypropylene (PP) | ECWF(A) Rating 250 V DC | 105 °C | 105 °C | Voltage reduction is unnecessary. |
| | ECWF(L) | | | |
| | ECWH(A) | | | |
| | ECWF(A) Rating 450 V DC | 85 °C | 105 °C | 1.25%/ °C |
| | ECWF(A) Rating 630 V DC | | | |
| | ECWH(V) | 85 °C | 105 °C | 1.0%/ °C |
| ECWFE Rating 450 V DC | | | | |
| ECWFD Rating 630 V DC | | | | |
| Polyethylene naphthalate (PEN) | ECWFE Rating 630 V DC | 85 °C | 105 °C | 1.0%/ °C |
| | ECWFD Rating 450 V DC | | | |
| | ECWFG Rating 630 V DC | 85 °C | 110 °C | 0.62%/ °C |
| | ECWF(X) | | | |
| | ECWF(C) | | | |
| Polyphenylene sulfide (PPS) | ECWF(V16) | 85 °C | 85 °C | Voltage reduction is unnecessary. |
| | ECHU(X) Rating 16 V DC | | | |
| | ECHU(X) Rating 50 V DC (0.0001 μF to 0.10 μF) | | | |
| Acrylic resin | ECHU(X) Rating 50 V DC (0.12 μF to 0.22 μF) | 105 °C | 125 °C | Voltage reduction is unnecessary. |
| | ECHU(C) | 105 °C | 105 °C | 1.25%/ °C |
| | ECHU(A) | 105 °C | 105 °C | Voltage reduction is unnecessary. |

※Rated temperature: upper limit temperature that can be used continuously without involving voltage reduction (which includes the self-temperature rise value)

※Category upper limit temperature: upper limit temperature that can be used continuously when voltage reduction is implemented (which includes the self-temperature rise value)

<Voltage reduction example>

When the rated temperature is 85 °C and the category upper limit temperature is 105 °C, voltage reduction is carried out at a reduction rate of 1.25 %/ °C in a temperature range of 85 °C or higher.

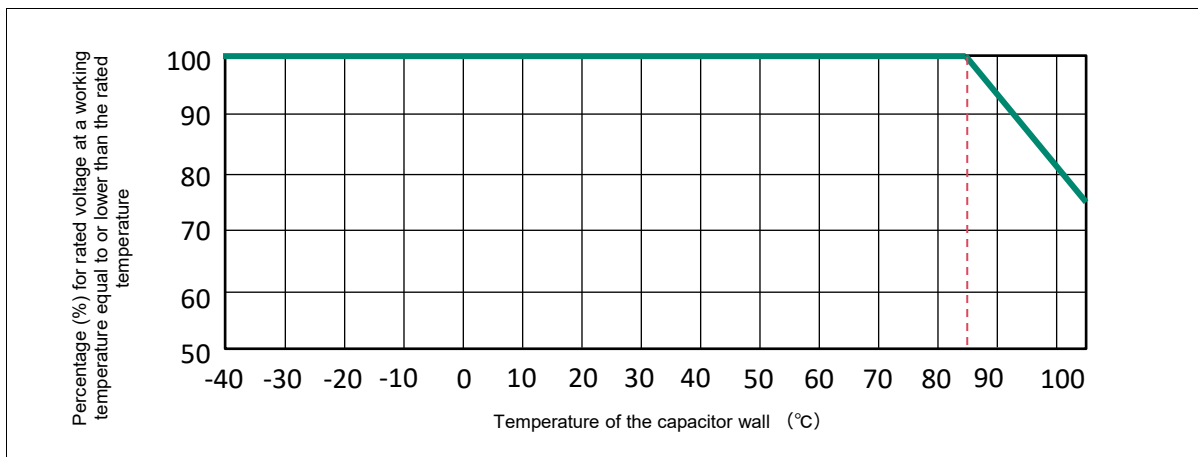

- Use the noise-preventing capacitor (AC rated voltage type) on the primary power circuit. This capacitor is designed on the assumption that a 50 Hz or 60 Hz sine wave voltage is applied to the capacitor. When using a capacitor with a DC rated voltage type in an AC circuit, see "Voltage at Which DC Rated Voltage Type Capacitor Can be Used in AC Circuit."
" Do not use this type of capacitor on the primary power circuit.
- When a capacitor is used at a high frequency, its self-heating poses a risk of thermal runaway (smoke generation, ignition). Reduce the working voltage according to the example shown below. For capacitors used at a high frequency, we recommend ECHU(X)/(C), ECWF(A)/(L), and ECWH(A)/(C)/(V).

<Example of working voltage reduction>

Capacitor: ECWF2154JA (250 V DC, 0.15 μF) Working frequency: 40 kHz (sine wave)
Allowable current value (entered in the delivery specification sheet): 2.0 Arms at 40 kHz

$$V = \frac{I}{2\pi fC} = \frac{2.0}{2 \times 3.14 \times 40 \times 10^3 \times 0.15 \times 10^{-6}} = 53 \text{ Vrms}$$

According to the above equation, the AC working voltage (50 Hz or 60 Hz sine wave voltage) of ECWF(A) operating at 40 kHz and 53 Vrms is calculated at 125 Vrms. This indicates that using ECWF(A) at a high frequency causes its allowable voltage to drop. Note that this equation cannot be applied to a working voltage not in a sine waveform, in which case please contact with us.

- Make sure that the peak value of a pulse voltage (Vo-p) applied across both ends of the capacitor is equal to or lower than the rated DC voltage. When the capacitor is used at a high frequency, its self-heating impairs the voltage endurance characteristics and may lead to destruction of the capacitor. Measure the self-temperature rise value of the capacitor and keep it equal to or lower than the specified value.
- When a voltage higher than the rated voltage (allowable voltage) is applied to the capacitor as a result of unusual circuit behavior caused by a failure of a different component, provide the capacitor with a means of safety protection.

Circuit design (working current)

- Because of its low internal impedance, the capacitor carries an extremely large current flow, depending on the circuit in which the capacitor is incorporated. Particularly, a high pulse current could flow through the capacitor when the power supply is turned on or off. Make sure to check whether a high pulse current is flowing through the capacitor. When the capacitor is used in a high-frequency circuit, such as an inverter circuit and switching circuit, a large current may flow through the capacitor. Be careful in such cases.
- A current flow exceeding the allowable current value may put the capacitor in a low-capacitance or open state or cause the capacitor to generate heat. This may result in degraded voltage endurance performance or short circuit, thus leading to smoke generation, ignition, etc. When using the capacitor, keep a capacitor current and temperature equal to or lower than the allowable current value and self-temperature rise value specified in the delivery specification sheet.
- It is necessary that the allowable current in breakdown mode be examined in terms of both pulse current (peak current) and continuous current (RMS current). Confirm that both pulse current and continuous current are equal to or lower than the allowable current value and then use the capacitor.
- The frequency characteristics of the loss tangent ($\tan\delta$) of a capacitor vary depending on the type of a dielectric material used. For this reason, a different allowable RMS current for a given working frequency shows depending on the product type. When a capacitor is used at a high frequency, in particular, its loss tangent ($\tan\delta$) gets larger, a current flow larger than the RMS current causes the capacitor to thermally runaway, which may lead to smoke generation or ignition. Using the capacitor at a high frequency, therefore, requires special caution. Please let us know the operating conditions for the capacitor to give you detailed advice. Otherwise, keep the self-temperature rise value and surface temperature of the capacitor within the allowable range even in the most unfavorable operation conditions.

- The RMS current (effective current) varies depending on the capacitance. The following graphs show allowable RMS currents (effective currents) of typical capacitor types by frequency/capacitance. When actually using these capacitors, measure their voltage/current waveforms and ambient temperatures/self-temperature rise values and give us these measurements with your inquiries.

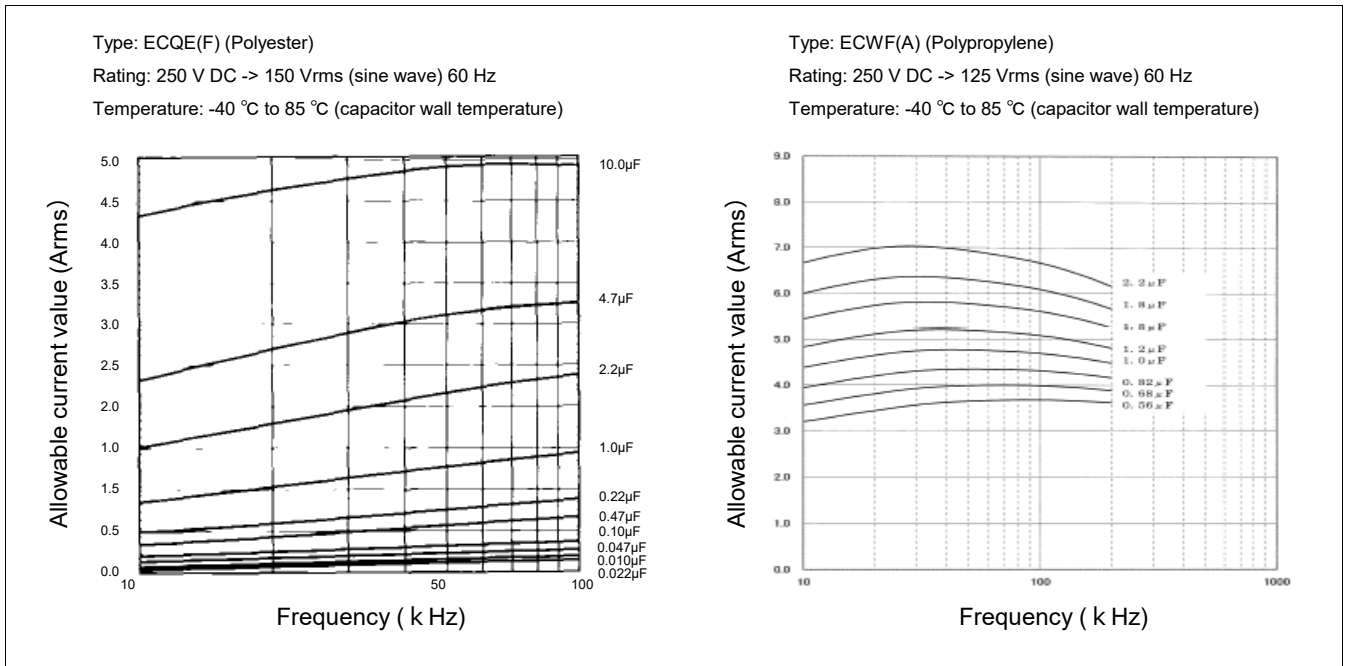

- When the capacitor is used in a switching circuit or snubber circuit, an instantaneous flow of large pulse current causes the capacitor to locally generate heat. As a result, the film deposit scatters off, which may decrease the capacitance of the capacitor or put the capacitor in an open state. This local heating may trigger a smoke generation or ignition incident.
- A pulse current value (10000 times) can be given as the product of dV/dt (V/ μ s) and a capacitance (μ F) that are specified in the delivery specification sheet. dV/dt is determined by the element structure.
- When the capacitor is used in a large-current pulse circuit, keep the pulse current value within the allowable pulse current (Ao-p). When applying a pulse current 10000 times or more, please contact us to discuss the matter separately.

- When a voltage V (V) is applied to a capacitor C (farad or F), a charge quantity Q (C) is given as $Q = C \cdot V$.
At this time, a charge current I (A) flowing through the capacitor is given as $I = dQ/dt$. It follows, therefore, that a pulse current I (A) is given as the product of a capacitance C (μF) and a voltage variation per time dV/dt, that is, $I = C \cdot dV/dt$.

<Allowable dV/dt value of ECQE(F) to which a pulse current is applied 10000 times or less>

| Capacitance (μF) | Type | | | |
|---------------------|----------|----------|----------|----------|
| | ECQE(F) | ECQE(F) | ECQE(F) | ECQE(F) |
| | 100 V DC | 250 V DC | 400 V DC | 630 V DC |
| 103 (0.010) | | | 131 | 273 |
| 123 (0.012) | | | | |
| 153 (0.015) | | | | |
| 183 (0.018) | | | | |
| 223 (0.022) | | | | |
| 273 (0.027) | | | | |
| 333 (0.033) | | | | |
| 393 (0.039) | | | | |
| 473 (0.047) | | | | |
| 563 (0.056) | | | | |
| 683 (0.068) | | | | |
| 823 (0.082) | | | | |
| 104 (0.10) | | | | |
| 124 (0.12) | | | | |
| 154 (0.15) | | | | |
| 184 (0.18) | | | | |
| 224 (0.22) | | | | |
| 274 (0.27) | | | | |
| 334 (0.33) | | | | |
| 394 (0.39) | | | | |
| 474 (0.47) | | | | |
| 564 (0.56) | | | | |
| 684 (0.68) | | | | |
| 824 (0.82) | | | | |
| 105 (1.0) | | | | |
| 125 (1.2) | | | | |
| 155 (1.5) | | | | |
| 185 (1.8) | | | | |
| 225 (2.2) | | | | |
| 275 (2.7) | | | | |
| 335 (3.3) | | | | |
| 395 (3.9) | | | | |
| 475 (4.7) | | | | |
| 565 (5.6) | | | | |
| 685 (6.8) | | | | |
| 825 (8.2) | | | | |
| 106 (10.0) | | | | |

From the above table, which indicates that the allowable dV/dt value of ECQE4224KF (rated voltage 400 V DC, capacitance 0.22 μF) is 37, the allowable pulse current value of ECQE4224KF is calculated at 8 A. Ensure, however, that the RMS current value is equal to or lower than the allowable RMS current value.

- When a voltage V (V) is applied to a capacitor C (farad or F), the charge quantity Q (C) is given as $Q = C \cdot V$.
At this time, the charge current I (A) flowing through the capacitor is given as $I = dQ/dt$. It follows, therefore, that the pulse current I (A) is given as the product of the capacitance C (μF) and the voltage variation per time dV/dt, that is, $I = C \cdot dV/dt$.

<Allowable dV/dt value of ECQE(F) to which a pulse current is applied 10000 times or less>

| Capacitance (μF) | Type | | | |
|---------------------|----------|----------|----------|----------|
| | ECQE(F) | ECQE(F) | ECQE(F) | ECQE(F) |
| | 100 V DC | 250 V DC | 400 V DC | 630 V DC |
| 103 (0.010) | | | 131 | 273 |
| 123 (0.012) | | | | |
| 153 (0.015) | | | | |
| 183 (0.018) | | | | |
| 223 (0.022) | | | | |
| 273 (0.027) | | | | |
| 333 (0.033) | | | | |
| 393 (0.039) | | | | |
| 473 (0.047) | | | | |
| 563 (0.056) | | | | |
| 683 (0.068) | | | | |
| 823 (0.082) | | | | |
| 104 (0.10) | | | | |
| 124 (0.12) | | | | |
| 154 (0.15) | | | | |
| 184 (0.18) | | | | |
| 224 (0.22) | | | | |
| 274 (0.27) | | | | |
| 334 (0.33) | | | | |
| 394 (0.39) | | | | |
| 474 (0.47) | | | | |
| 564 (0.56) | | | | |
| 684 (0.68) | | | | |
| 824 (0.82) | | | | |
| 105 (1.0) | | | | |
| 125 (1.2) | | | | |
| 155 (1.5) | | | | |
| 185 (1.8) | | | | |
| 225 (2.2) | | | | |
| 275 (2.7) | | | | |
| 335 (3.3) | | | | |
| 395 (3.9) | | | | |
| 475 (4.7) | | | | |
| 565 (5.6) | | | | |
| 685 (6.8) | | | | |
| 825 (8.2) | | | | |
| 106 (10.0) | | | | |

From the above table, which indicates that the allowable dV/dt value of ECQE4224KF (rated voltage 400 V DC, capacitance 0.22 μF) is 37, the allowable pulse current value of ECQE4224KF is calculated at 8 Ao-p. Ensure, however, that the RMS current value is equal to or lower than the allowable RMS current value.

Circuit design (working temperature)

- When the capacitor is used in an AC circuit, especially in a high-frequency circuit, the capacitor generates heat because of the alternating current flowing therethrough. If this self-heating by the capacitor is excessive, the capacitor may deteriorate or generate smoke or even ignite. Confirm the self-temperature rise value of the capacitor under the actual service condition and use the capacitor at the self-temperature rise value equal to or lower than the specified self-temperature rise value.

Measure the self-temperature rise value at room temperature in a windless condition. Refer to the delivery specification sheet to check detailed information on the self-temperature rise value.

The specified self-temperature rise value varies depending on capacitor types. For more detailed information about this matter, please contact us.

- Because the working temperature range of a capacitor varies depending on dielectric materials (film types), the working temperature range in which the capacitor can be used is specified for each capacitor type.

Note, however, that working temperature ranges listed in a catalog are surface temperatures which are different from ambient temperatures. When using the capacitor, make sure that (ambient temperature + self-temperature rise value (within the specified value)), that is, the surface temperature of the capacitor is within the working temperature range.

- If the capacitor is used in a temperature condition above the working temperature range, its loss tangent ($\tan \delta$) gets larger, inducing self-heating, which leads to exceeding the allowable value. As a result, the dielectric film deteriorates which can cause a short circuit failure that may lead to smoke generation or ignition. When a heat dissipation plate of a different component or resistance generating high heat is present near the capacitor, radiant heat from such an element is applied to a part of the capacitor, in which case the temperature of the capacitor can exceed the working temperature range and smoke generation or ignition may occur. Make sure to check the surface temperature of elements that serve as a heat source.

Board design

- The chip-type laminated film capacitor is mounted directly on the board without a lead interposed between the capacitor and the board. Because of this configuration, if the thermal expansion coefficient of the capacitor and that of the board differ widely, due to temperature change, etc., after chip mounting, it creates mechanical stress which is applied to the capacitor. This deforms the capacitor body or cracks its soldered part, thus impairing its performance. Examine and check the capacitor sufficiently before mounting it on the board. In particular, when using a ceramic board, please contact us before mounting the capacitor.

<Thermal expansion coefficients of boards and chip-type laminated film capacitors>

| Type Item | Chip-type laminated film capacitor | | | Resin board | | | Ceramic board |
|--|------------------------------------|---------------------------|---------------------------|--------------|-------------|-------------|---------------|
| | ECHU(X)/(C) (PPS film) | ECWU(X)/(C) (PEN film) | ECPU(A) (Plastic film) | Paper phenol | Paper epoxy | Glass epoxy | Alumina |
| Thermal expansion coefficient ($\times 10^{-6}/^{\circ}\text{C}$) | 22 | 10 | 70 | 1 ~ 30 | 1 ~ 15 | 1 ~ 25 | 7 ~ 8 |

- Radiant heat from a heat-carrying component present near the capacitor may raise the temperature of the capacitor above the category temperature range. Be careful in such cases. The chip-type capacitor does not have the outer casing that the lead-type capacitor has. If an exposed part of a live component is present near the capacitor, a short circuit may be created through the capacitor. Exercise special caution when determining the location of the capacitor.
- If the land area of the capacitor is large, a tombstone phenomenon (chip rising) is likely to occur when the volume of solder is not proper. Give each type of capacitor recommended land dimensions as much as possible, even though it is disadvantageous from the viewpoint of ensuring the moulder has sufficient mount clearance.

Mounting conditions (chip-type) * Target capacitors: ECHU, ECWU, and ECPU

- In the flow soldering process, a chip component is dipped in melted solder and resulting in a high temperature of the component. The film capacitor has low resistance to heat. Avoid soldering it using the flow soldering process. Applying heat directly to a capacitor from the lower surface of the printed board for repair work (using a hot plate, etc.) may result in the degradation of the capacitor. This process must also be avoided.

- Reflow soldering is a soldering method in which the proper amount of solder paste is deposited on the fitting land of the surface-mounted board, the chip-type laminated film capacitor is placed on the land, and heat is applied to the capacitor to melt the solder. We recommend the temperature profile shown in the following table for the reflow soldering process. Note, however, that more than two reflow soldering cycles are not allowed and that the second reflow cycle must be carried out after the capacitor temperature returns to normal temperature following the end of the first reflow cycle.

| Soldering | Item | Soldering condition | Mater to note |
|-----------|--|---------------------|--|
| | <Reflow soldering> The capacitor and the board are heated in a heat-resistant furnace or an infrared furnace. | | The capacitor temperature varies depending on the type of the board material and the heat source. Use a glass epoxy board of 115 mm by 50 mm and 0.8 t as the standard board to check the capacitor temperature. |

- Because the chip-type laminated film capacitor is not protected with an outer casing, an activator (halogen, etc.) in solder paste may corrode the inner deposit electrode, which leads to the degradation of the capacitor characteristics, such as a drop in the capacitance and an increase in the loss tangent ($\tan\delta$). Use solder paste with halogen content of 0.1 wt%.
- When cleaning the capacitor right after soldering it, make sure that its surface temperature is 60 °C or lower.
- Maximum surface temperatures capacitors reach during the reflow process are as follows: 260 °C at ECHU(X)/(C), 250 °C at ECWU(X)/(C), and 240 °C at ECPU(A).
A surface temperature higher than these temperatures causes a capacitor problems with its appearance and electrical characteristics, in which case the reliability of the capacitor cannot be guaranteed.
- ECWU(X)/(C) and ECPU(A) are put in moisture proofing packages. Once the package is unsealed, the capacitor absorbs moisture and its resistance to soldering heat drops. Check the note on the package that gives you the instructions you should follow after unsealing the package. Specific instructions to follow after unsealing the package are stated in the delivery specification sheet.
- When using a solder iron, sufficiently preheat the board land with the iron tip and then carry out soldering work. Do not put the iron tip directly on the body or electrode of a chip-type laminated film capacitor. Particularly, do not bring the iron tip into contact with a side face (sectional surface) of the capacitor. A hot solder iron coming in contact with such parts may cause the degradation of the capacitor characteristics, such as lower insulation resistance and short circuit.
- Avoid mounting a number of chip-type laminated film capacitors on a board using a solder iron. This process makes temperature control difficult and may lead to the degradation of the capacitor characteristics. Avoid reusing a capacitor (component) once removed with a solder iron.

| | ECHU(X)/(C) | ECWU(X)/(C) | ECPU(A) |
|---------------------------|---------------------------|----------------------|----------------------|
| | 270°C max. – 4s max. | 260°C max. – 4s max. | 280°C max. – 4s max. |
| Solder iron use condition | | | |
| | Solder iron wattage: 30 W | | |

Mounting conditions (lead-type) * Target capacitors: ECQE, ECWF, ECWH, and ECQU

■ The heat-resistant temperature of a capacitor varies depending on the type of a dielectric film used and on the structure and manufacturing method of the capacitor. When mounting the capacitor on a board, set the mounting temperature such that the internal temperature of the capacitor (see the figure on the right) is equal to or lower than the mounting heat-resistant temperature listed in the following table.

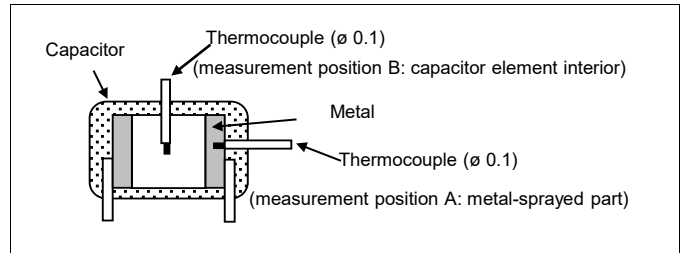

When a capacitor is sent through a high-temperature atmosphere after being subjected to the (flow) soldering process, check the mounting temperature including the temperature of the capacitor in the high-temperature atmosphere.

| Dielectric material | Type | Mounting heat-resistant temperature (peak value) | |
|---------------------|---|--|------------------------|
| | | Measurement position A | Measurement position B |
| Polypropylene-based | ECWF(L) 400 V / 0.022 μF to 0.11 μF, ECWF(L) 630 V / 0.01 μF to 0.043 μF, ECWF(A) | 135 °C | 125 °C |
| | ECWF(L) 400 V / 0.12 μF to 2.4 μF, ECWF(L) 630 V / 0.047 μF to 1.3 μF, ECWFE 630 V, ECWFG 630 V | 145 °C | 125 °C |
| | ECWH(A), ECWH(V), ECWFD 630 V | 135 °C | 125 °C |
| | ECWH(C) | 140 °C | 125 °C |
| | ECWFD 450 V | 135 °C | — |
| | ECQUA, ECWFE 450 V | 125 °C | — |
| Polyester-based | ECQE(F) | — | 120 °C |
| | ECQE(B), ECQE(T), ECQUL, ECQUG | 160 °C | — |

■ Set temperature conditions for soldering within the ranges shown in the graph on the right (make sure to confirm that the set temperature conditions are equal to or lower than the mounting heat-resistant temperature because temperature conditions vary significantly depending on the equipment structure). Carry out no more than two soldering cycles and in such a way that the second soldering cycle is only carried out after the capacitor temperature returns to a normal temperature following the end of the first cycle.

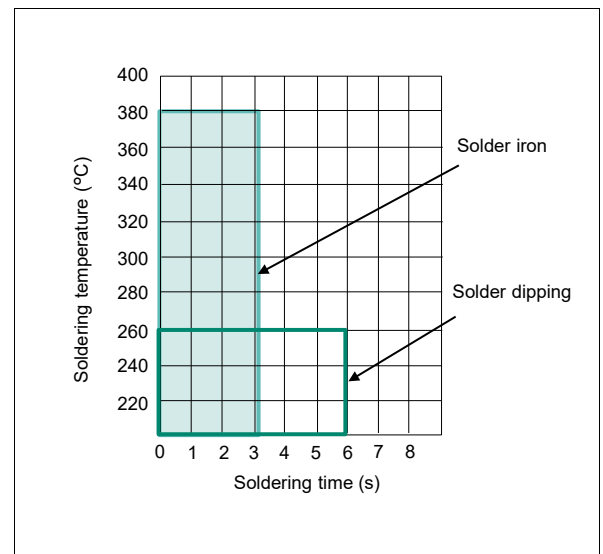

<Condition example>

| Printed circuit board | Board thickness of 0.8 mm or more |
|-----------------------|---|
| Preheating | At 120 °C or less for 1 minute or less (the preheating time and final temperature reached around the land on the back of the board) |
| Capacitor body | There is a certain type of capacitor that must be lifted upward from the printed board. (processed product) |

- Since the mounting heat-resistant temperature of the capacitor is low, avoid running the capacitor through an adhesive curing oven for fixing chip components. In the oven, the capacitor is exposed to heat higher than the mounting heat-resistant temperature, which causes the dielectric film to thermally shrink, thus causing a short failure.
- When a film capacitor is used with chip components, mount the film capacitor and solder it after the adhesive has cured.
- Do not perform reflow soldering for the capacitor. During reflow soldering, if heat higher than the mounting heat-resistant temperature is applied to the capacitor, it could damage the exterior resin and impair the capacitor characteristics.

- When the capacitor is mounted on a multilayer board or has copper leads, the internal temperature of the capacitor readily increases because of the high heat conductivity of the copper leads, and therefore the capacitor temperature may rise above the mounting heat-resistant temperature. In such a case, contact us for some advice.
- Excessive heat stress that is applied to the capacitor during the mounting process causes the dielectric film to thermally shrink, which may make the connection of the metal-sprayed part unstable. Current flowing through the capacitor in this state may reduce its capacitance and put it in open mode. When the capacitor is laid down on its side on the board, solder the the capacitor so that a thermocouple inserted between the capacitor and the board shows 125 °C or lower.

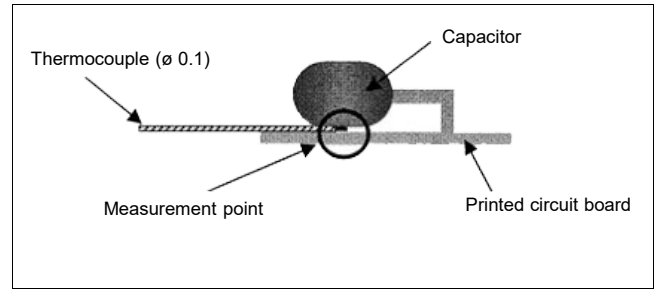

Mounting conditions (temperature measurement)

- When using a chip-type capacitor, measure the temperature profile of the mounted capacitor by the following method so that the capacitor is soldered at a temperature equal to or lower than the heat-resistant temperature.

<Creating a measurement sample>

Bond a thermocouple (ø 0.1 T) to the upper surface of the capacitor with an adhesive.

<Measuring a temperature profile>

As shown in the following diagram, connect the same type of thermocouple (3 m to 4 m) as the thermocouple bonded to the capacitor, to the measuring device.

Mount the sample capacitor on the board, subject the capacitor to the soldering process, and measure the temperature profile of the capacitor.

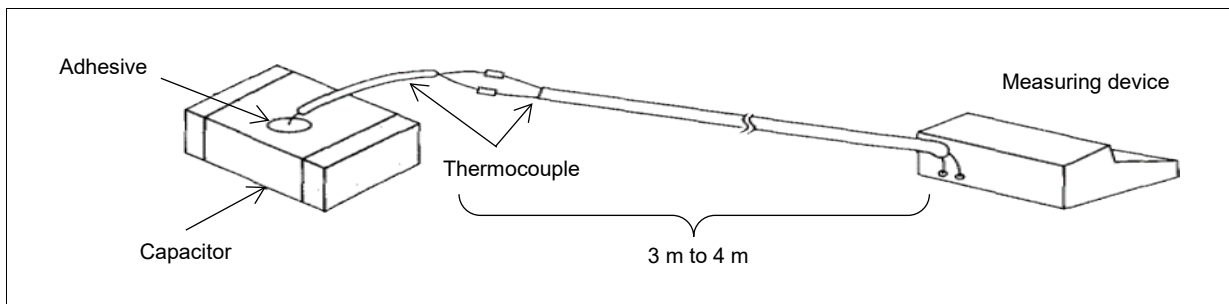

- When using a lead-type capacitor with a low mounting heat-resistant temperature, measure the temperature profile of the mounted capacitor by the following method so that the capacitor is soldered at a temperature equal to or lower than the heat-resistant temperature.

<Creating a measurement sample>

Drill a hole of 0.3 mm to 0.8 mm in diameter on the top of the capacitor, the hole being deep enough to reach the central part of the capacitor, and insert a thermocouple (ø 0.1 T) in the hole, affix the thermocouple with an adhesive.

<Measuring a temperature profile>

As shown in the following diagram, connect the same type of thermocouple (3 m to 4 m) as the thermocouple bonded to the capacitor, to the measuring device.

Mount the sample capacitor on the board, subject the capacitor to the soldering process, and measure the temperature profile of the capacitor.

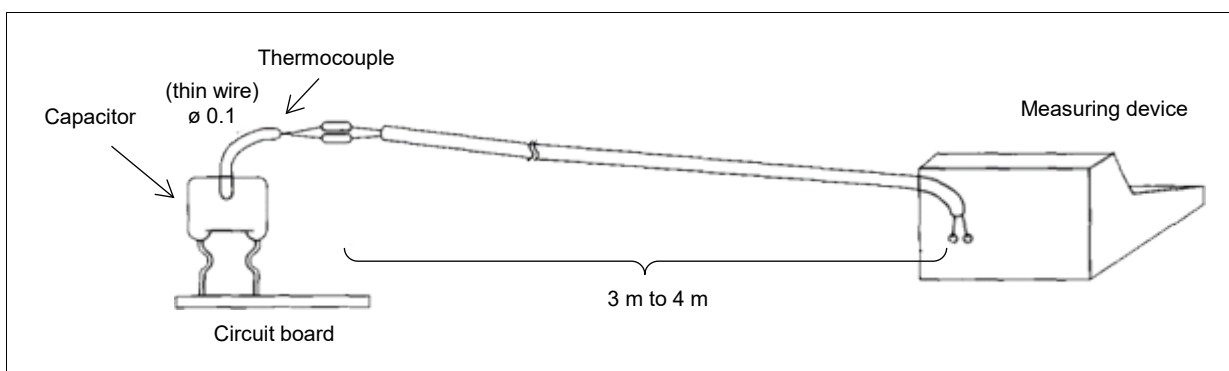

Storage conditions

- Do not store the capacitor in a place where moisture, dust, or corrosive gas (hydrogen chloride, hydrogen sulfide, sulfur dioxide, ammonia, etc.) is present. It may impair the solderability of the external electrodes.
- Avoid a high-temperature/high-humidity place and keep the capacitor in a place where the temperature/humidity condition is controlled at 35 °C and 85%RH or lower.
- A capacitor kept in storage for a long period will have oxidized leads surface resulting in lower solderability. Make the storage period as short as possible (about 6 months).
Storage conditions vary depending on capacitor types. For more detailed information, please contact us.

Reference information

Guidelines

Before using the capacitor, make sure to acquire our delivery specification sheet and confirm service conditions. If you find measurement values exceeding specified values in the specification sheet or have any question, feel free to contact us. We also advise you to refer to RCR-1001B "Safety Application Guide on Components for Use in Electronic and Electrical Equipment" and JEITA RCR-2350D "Safety Application Guide for Fixed Plastic Film Capacitors for Use in Electronic Equipment."





Looking for pricing, stock, or lifecycle information?

Click below to explore more details on WIN SOURCE:

 [View ECQ-E1225KFB on WIN SOURCE](#)

 [Panasonic Information](#)

Optimize Your Supply Chain with WIN SOURCE Solutions

-  Global Sourcing Solution
-  Obsolete Management
-  Cost Control Management
-  Shortage Management
-  Alternative Solution
-  Excess Inventory Management