

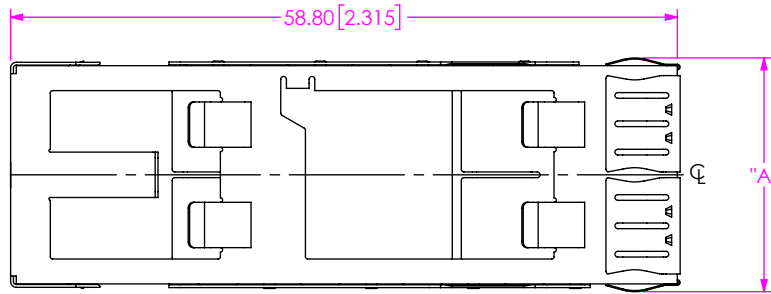

THE DATASHEET OF QSFPC-PF-01



DO NOT SCALE FROM THIS PRINT



FUTURE STACKED CAGES

-1: SINGLE HIGH

FLYOVER

(SEE TABLE 2)
(LEAVE BLANK FOR NON FLYOVER)
-F: FLYOVER

NO. OF PORTS

-1, -2, -3, -4
-5, -6

OPTIONS

(SEE TABLE 2)
(LEAVE BLANK FOR NO LIGHT PIPES)
-LP: LIGHTPIPE
-N : NO HEAT SINK CLOSED TOP
(SEE FIG 7)

EMI PANEL OPTION
(SEE TABLE 2)

-S: SPRING FINGERS

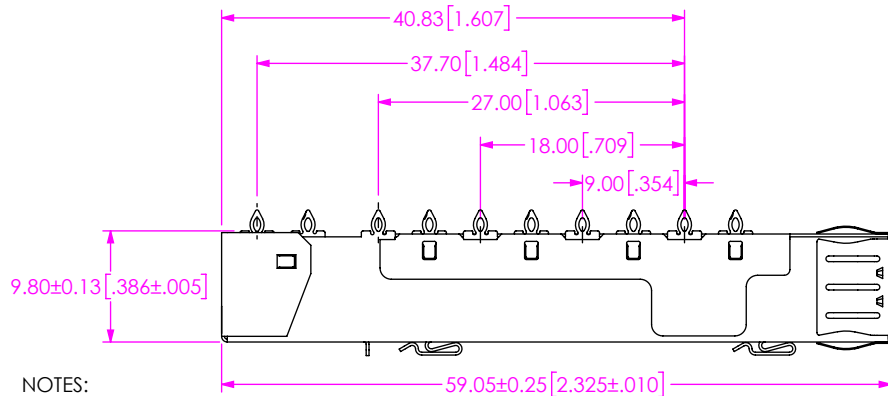
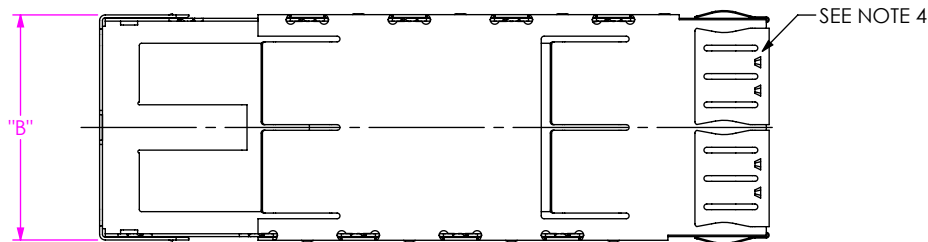
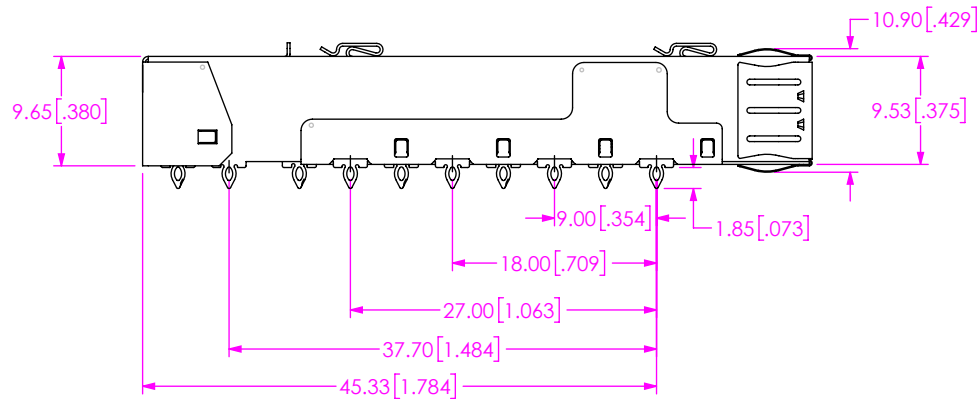
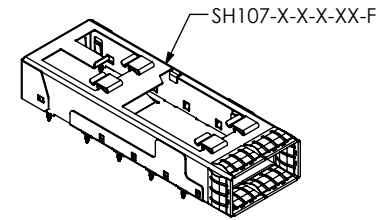
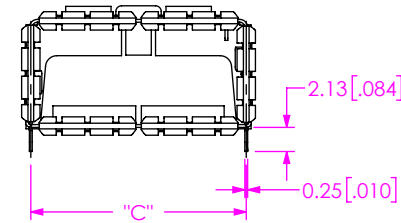

FIG 1
QSFP-C-1-1-S-F SHOWN

EMI PANEL OPTION	OPTIONS	FLYOVER	FUTURE STACKED CAGES					
			-1: SINGLE HIGH					
			NO. OF PORTS					
			1	2	3	4	5	6
-S: SPRING FINGERS	BLANK	BLANK	√	X	X	X	X	X
		-F	√	√	X	√	X	X
	-LP	BLANK	X	X	X	X	X	X
		-F	√	X	X	√	X	X
	-N	BLANK	◇	X	X	X	X	X
		-F	√	√	X	X	X	X

X= NOT TOOLED, √ = RELEASED, ◇ = NOT RELEASED

NO. OF PORTS	"A"	"B"± 0.13[.005]	"C"± 0.13[.005]
-1	20.62 [0.812]	19.85 [0.781]	19.00 [0.748]
-2	39.62 [1.560]	38.85 [1.530]	38.00 [1.496]
-3	58.62 [2.308]	57.85 [2.278]	57.00 [2.244]
-4	77.62 [3.056]	76.85 [3.026]	76.00 [2.992]
-5	96.62 [3.804]	95.85 [3.774]	95.00 [3.740]
-6	115.62 [4.552]	114.85 [4.522]	114.00 [4.488]

NOTES:

1. Ⓢ REPRESENTS A CRITICAL DIMENSION.
2. NOTED DELETED.
3. PULL AND SHIP PARTS IN TRAY, SEE TABLE 3.
4. EMI FINGERS WELDED IN CENTER AS SHOWN EXCEPT ON -N OPTION.

PROPRIETARY NOTE
THIS DOCUMENT CONTAINS CONFIDENTIAL AND PROPRIETARY INFORMATION AND ALL DESIGN, MANUFACTURING, REPRODUCTION, USE, PATENT RIGHTS AND SALES RIGHTS ARE EXPRESSLY RESERVED BY SAMTEC, INC. THIS DOCUMENT SHALL NOT BE DISCLOSED, IN WHOLE OR PART, TO ANY UNAUTHORIZED PERSON OR ENTITY NOR REPRODUCED, TRANSFERRED OR INCORPORATED IN ANY OTHER PROJECT IN ANY MANNER WITHOUT THE EXPRESS WRITTEN CONSENT OF SAMTEC, INC.

SHEET SCALE: 3:2
DO NOT SCALE DRAWING

MATERIAL: DO NOT SCALE DRAWING

CAGE: 7025, TM03
EMI FINGERS: STAINLESS STEEL SUS304



520 PARK EAST BLVD, NEW ALBANY, IN 47150
PHONE: 812-944-6733 FAX: 812-948-5047
e-Mail info@SAMTEC.com code 53322

DESCRIPTION:
FQSFP CAGE ASSEM

DWG. NO.
QSFP-C-X-X-X-XX-X

BY: JOE Z 06/20/2017 SHEET 1 OF 7

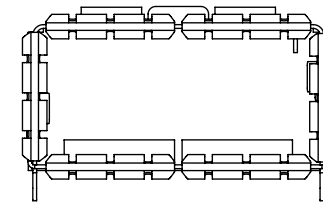
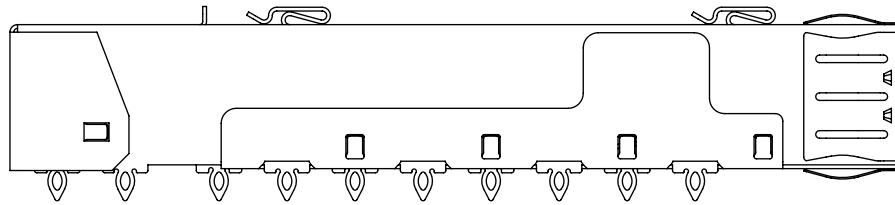

FIG 2
 QSFP-1-1-S SHOWN
 (DIFFERENT AS SHOWN, OTHERWISE SAME AS FIG 1)

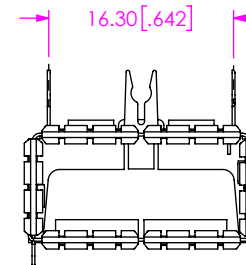
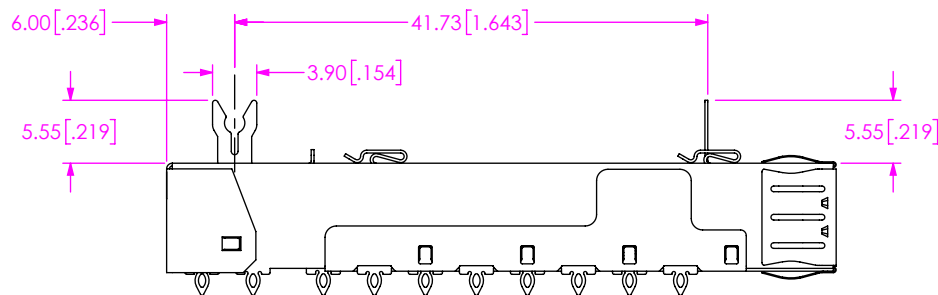
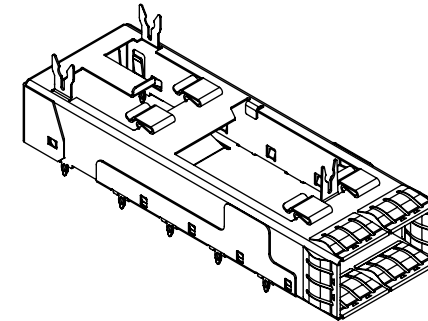
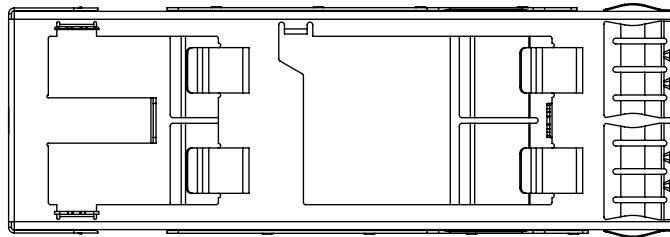

FIG 3
 QSFP-1-1-S-LP-F SHOWN
 (DIFFERENT AS SHOWN, OTHERWISE SAME AS FIG 1)

PROPRIETARY NOTE
 * * *
 THIS DOCUMENT CONTAINS CONFIDENTIAL AND PROPRIETARY INFORMATION AND ALL DESIGN, MANUFACTURING, REPRODUCTION, USE, PATENT RIGHTS AND SALES RIGHTS ARE EXPRESSLY RESERVED BY SAMTEC, INC. THIS DOCUMENT SHALL NOT BE DISCLOSED, IN WHOLE OR PART, TO ANY UNAUTHORIZED PERSON OR ENTITY NOR REPRODUCED, TRANSFERRED OR INCORPORATED IN ANY OTHER PROJECT IN ANY MANNER WITHOUT THE EXPRESS WRITTEN CONSENT OF SAMTEC, INC.

samtec
 520 PARK EAST BLVD, NEW ALBANY, IN 47150
 PHONE: 812-944-6733 FAX: 812-948-5047
 e-Mail info@SAMTEC.com code 55322

SHEET SCALE: 1:1

DESCRIPTION:
 FQSFP CAGE ASSEM

DWG. NO.
 QSFP-1-1-S-LP-F

BY: JOE Z 06/20/2017 SHEET 2 OF 7

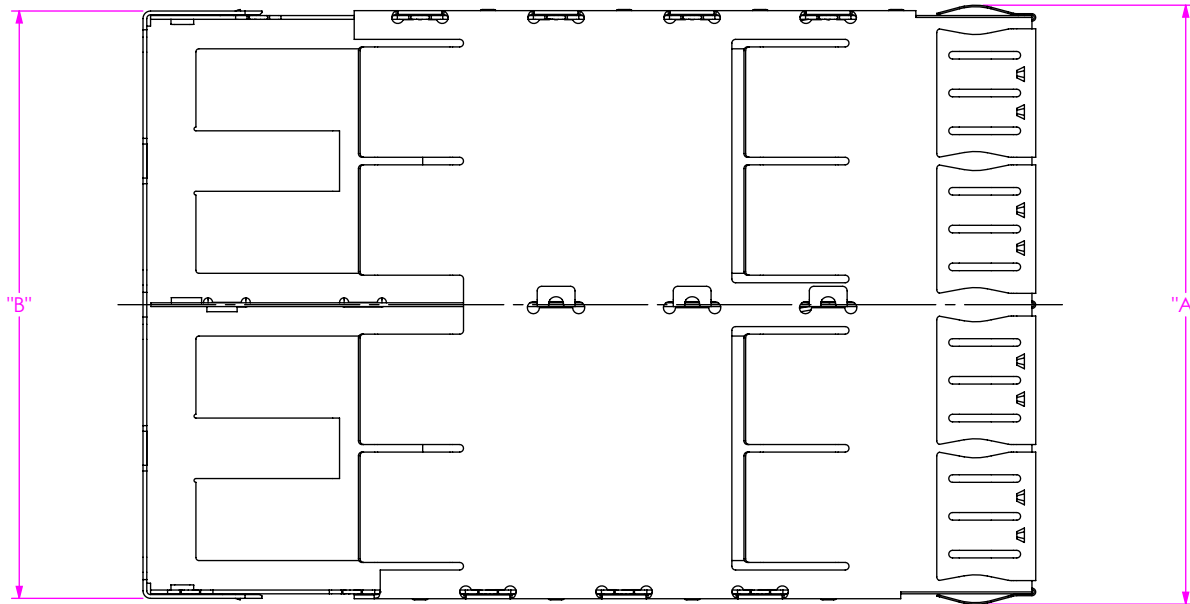
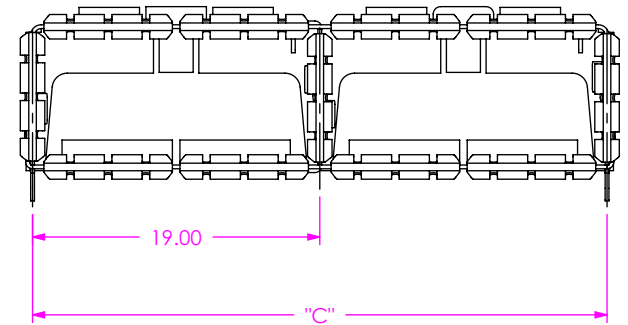
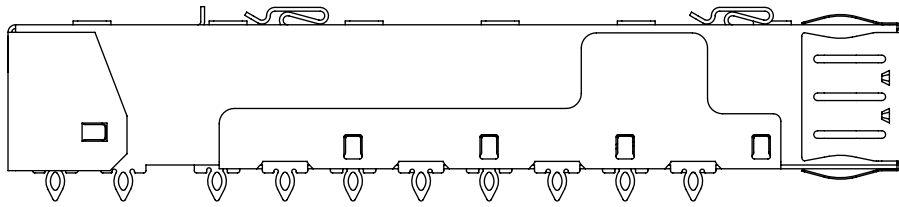

FIG 4
 QSFP-1-2-S-F SHOWN
 (DIFFERENT AS SHOWN, OTHERWISE SAME AS FIG 1)

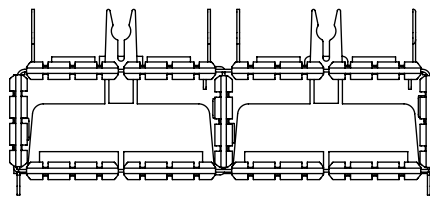
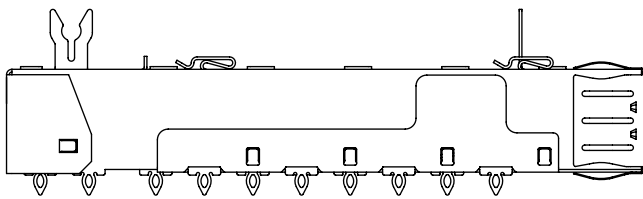

FIG 6
 QSFP-1-2-S-LP-F SHOWN
 (DIFFERENT AS SHOWN, OTHERWISE SAME AS FIG 3 & 4)

PROPRIETARY NOTE
 * THIS DOCUMENT CONTAINS CONFIDENTIAL AND PROPRIETARY INFORMATION AND ALL DESIGN, MANUFACTURING, REPRODUCTION, USE, PATENT RIGHTS AND SALES RIGHTS ARE EXPRESSLY RESERVED BY SAMTEC, INC. THIS DOCUMENT SHALL NOT BE DISCLOSED, IN WHOLE OR PART, TO ANY UNAUTHORIZED PERSON OR ENTITY NOR REPRODUCED, TRANSFERRED OR INCORPORATED IN ANY OTHER PROJECT IN ANY MANNER WITHOUT THE EXPRESS WRITTEN CONSENT OF SAMTEC, INC. *



520 PARK EAST BLVD, NEW ALBANY, IN 47150
 PHONE: 812-944-6733 FAX: 812-948-5047
 e-Mail info@SAMTEC.com code 55322

SHEET SCALE: 1:1

DESCRIPTION:
 FQSFP CAGE ASSEM

DWG. NO.
 QSFP-1-2-S-LP-F

BY: JOE Z 06/20/2017 SHEET 3 OF 7

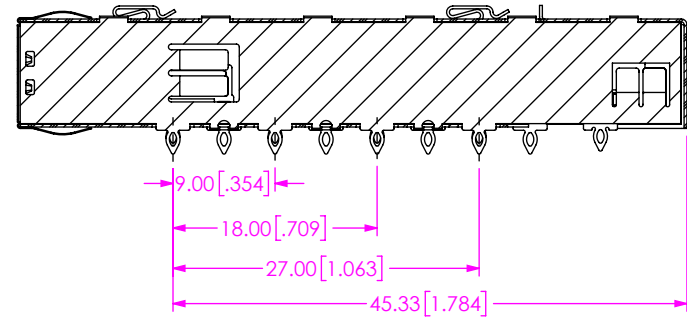
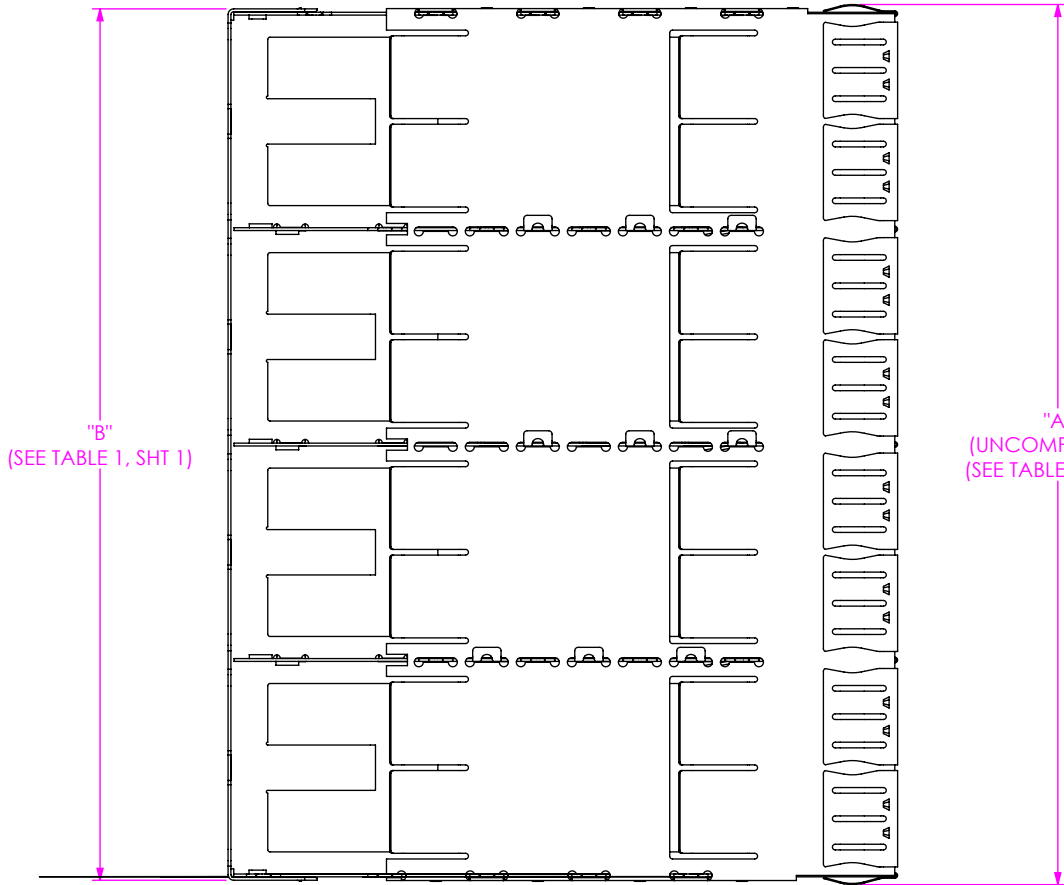
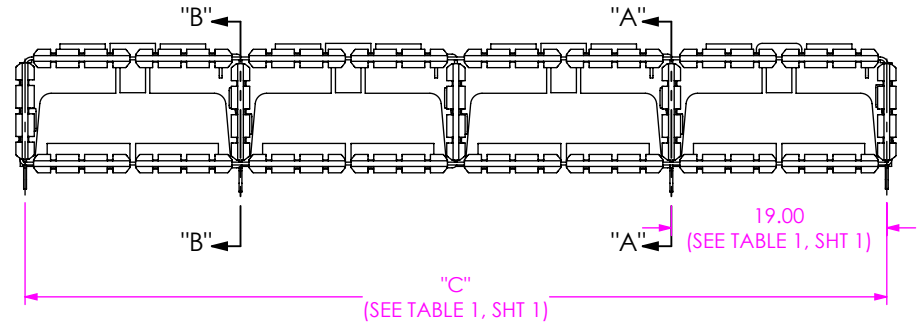
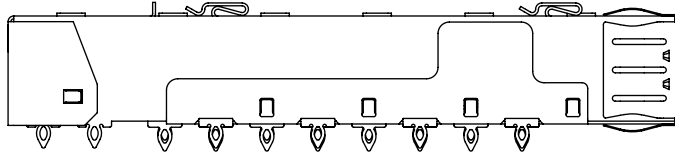

SECTION "A"- "A"
SCALE 1.5 : 1

"A"
(UNCOMPRESSED)
(SEE TABLE 1, SHT 1)

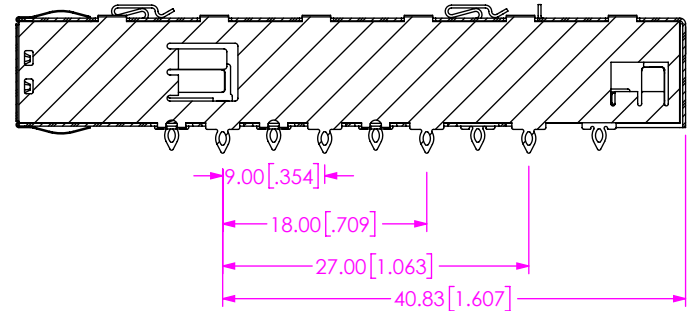

SECTION "B"- "B"
SCALE 1.5 : 1

FIG 5
QSFP-1-4-S-F SHOWN
(DIFFERENT AS SHOWN, OTHERWISE SAME AS FIG 4)

PROPRIETARY NOTE
THIS DOCUMENT CONTAINS CONFIDENTIAL AND PROPRIETARY INFORMATION AND ALL DESIGN, MANUFACTURING, REPRODUCTION, USE, PATENT RIGHTS AND SALES RIGHTS ARE EXPRESSLY RESERVED BY SAMTEC, INC. THIS DOCUMENT SHALL NOT BE DISCLOSED, IN WHOLE OR PART, TO ANY UNAUTHORIZED PERSON OR ENTITY NOR REPRODUCED, TRANSFERRED OR INCORPORATED IN ANY OTHER PROJECT IN ANY MANNER WITHOUT THE EXPRESS WRITTEN CONSENT OF SAMTEC, INC.



520 PARK EAST BLVD, NEW ALBANY, IN 47150
PHONE: 812-944-6733 FAX: 812-948-5047
e-Mail info@SAMTEC.com code 55322

SHEET SCALE: 1:1

DESCRIPTION:
FQSFP CAGE ASSEM

DWG. NO.
QSFP-1-4-S-F

BY: JOE Z 06/20/2017 SHEET 4 OF 7

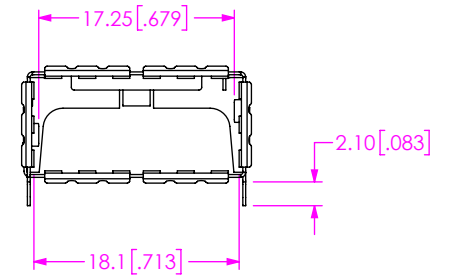
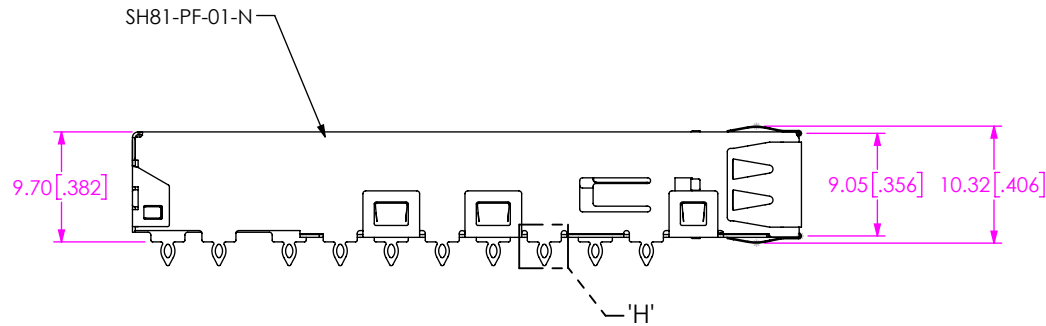
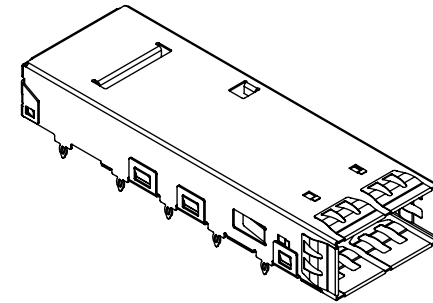
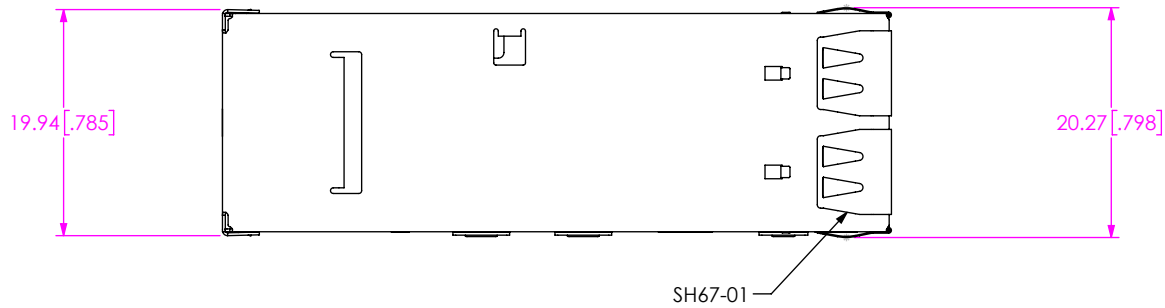
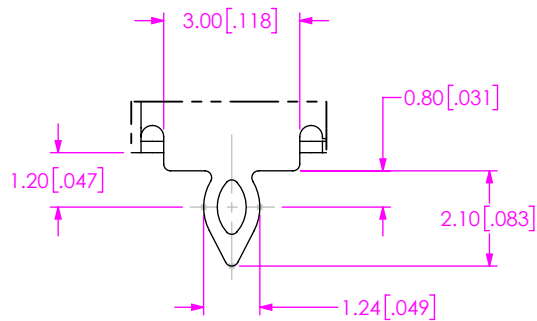

FIG 7
QSFP-1-1-S-N-F SHOWN
(SAME AS FIG 1, EXCEPT AS SHOWN)



DETAIL 'H'
SCALE 6 : 1

PROPRIETARY NOTE
THIS DOCUMENT CONTAINS CONFIDENTIAL AND PROPRIETARY INFORMATION AND ALL DESIGN, MANUFACTURING, REPRODUCTION, USE, PATENT RIGHTS AND SALES RIGHTS ARE EXPRESSLY RESERVED BY SAMTEC, INC. THIS DOCUMENT SHALL NOT BE DISCLOSED, IN WHOLE OR PART, TO ANY UNAUTHORIZED PERSON OR ENTITY NOR REPRODUCED, TRANSFERRED OR INCORPORATED IN ANY OTHER PROJECT IN ANY MANNER WITHOUT THE EXPRESS WRITTEN CONSENT OF SAMTEC, INC.



520 PARK EAST BLVD, NEW ALBANY, IN 47150
PHONE: 812-944-6733 FAX: 812-948-5047
e-Mail info@SAMTEC.com code 55322

SHEET SCALE: 1:1

DESCRIPTION:
FQSFP CAGE ASSEM

DWG. NO.
QSFP-1-1-S-N-F

BY: JOE Z 06/20/2017 SHEET 5 OF 7

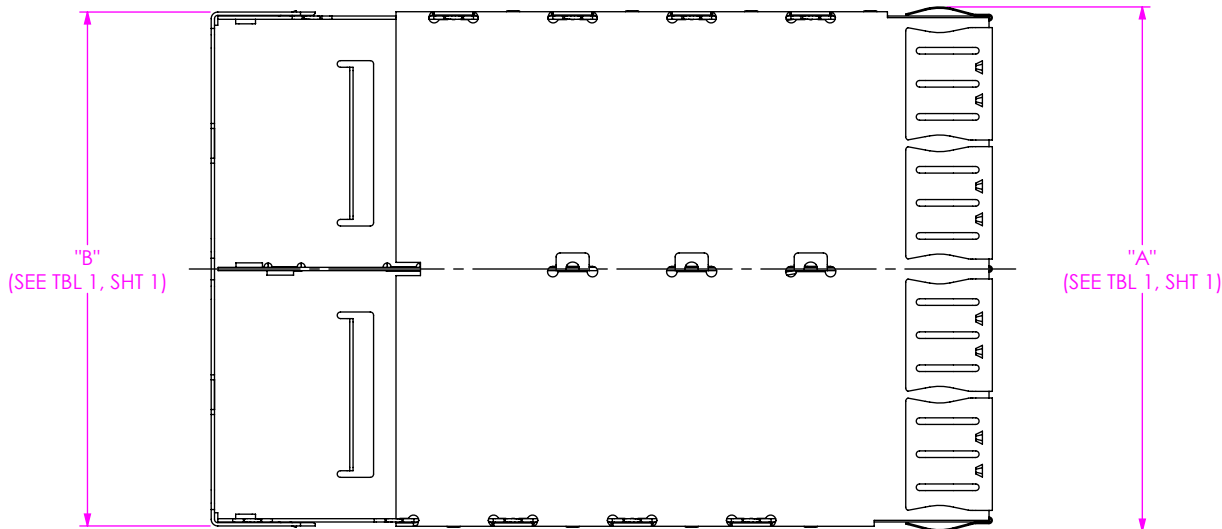
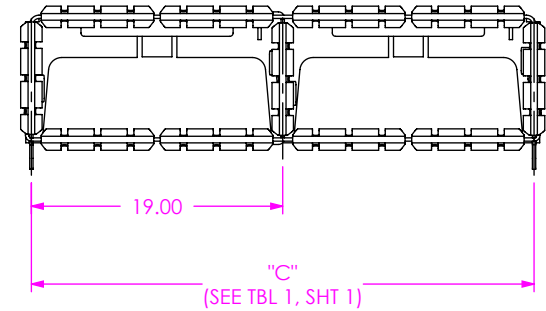
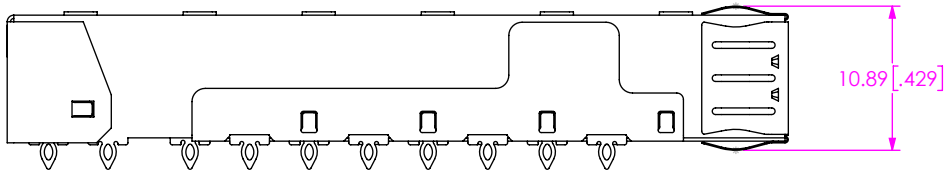
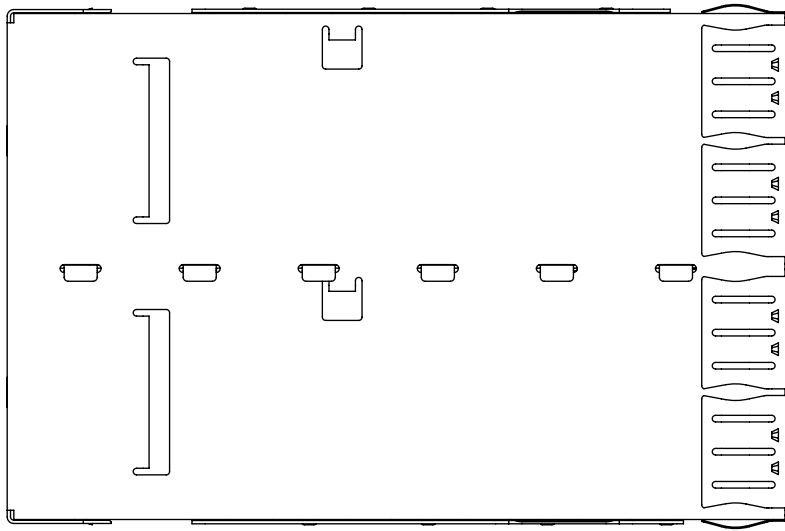

FIG 8
 QSFP-1-2-S-N-F SHOWN
 (DIFFERENT AS SHOWN, OTHERWISE SAME AS FIGS 1 & 4)

PROPRIETARY NOTE
 * THIS DOCUMENT CONTAINS CONFIDENTIAL AND PROPRIETARY INFORMATION AND ALL DESIGN, MANUFACTURING, REPRODUCTION, USE, PATENT RIGHTS AND SALES RIGHTS ARE EXPRESSLY RESERVED BY SAMTEC, INC. THIS DOCUMENT SHALL NOT BE DISCLOSED, IN WHOLE OR PART, TO ANY UNAUTHORIZED PERSON OR ENTITY NOR REPRODUCED, TRANSFERRED OR INCORPORATED IN ANY OTHER PROJECT IN ANY MANNER WITHOUT THE EXPRESS WRITTEN CONSENT OF SAMTEC, INC.

samtec
 520 PARK EAST BLVD, NEW ALBANY, IN 47150
 PHONE: 812-944-6733 FAX: 812-948-5047
 e-Mail info@SAMTEC.com code 55322

SHEET SCALE: 1:1

DESCRIPTION:
 FQSFP CAGE ASSEM
 DWG. NO.
 QSFP-1-2-S-N-F

BY: JOE Z 06/20/2017 SHEET 6 OF 7

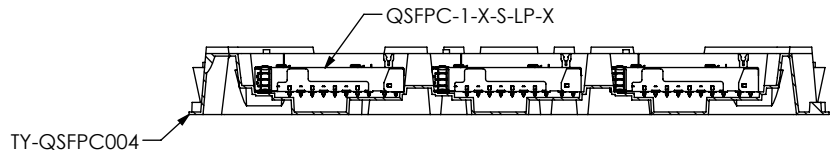
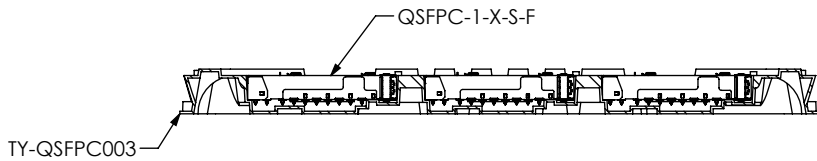
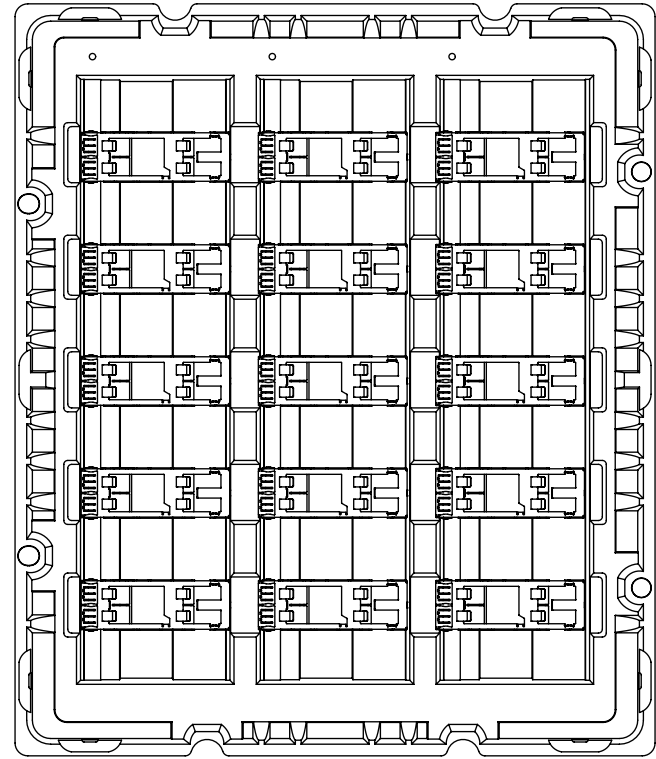
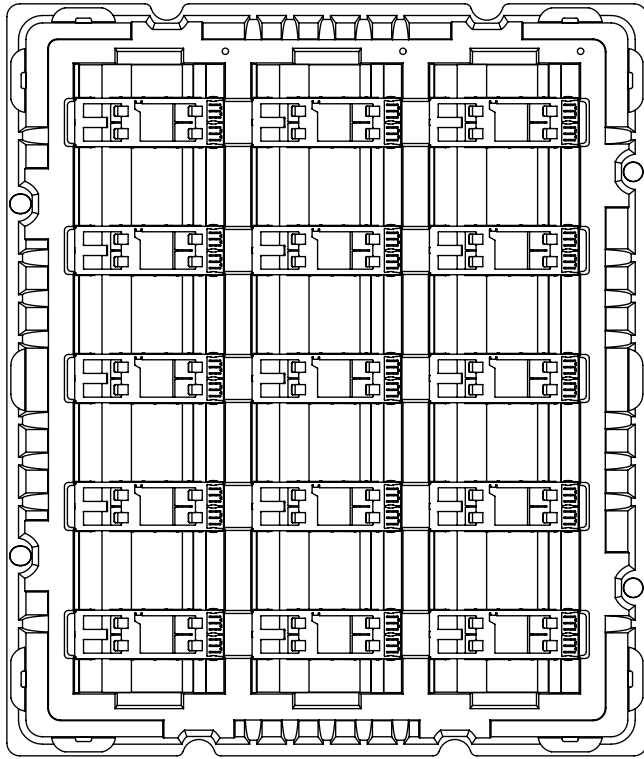

FIG 9
PACKAGING VIEW

TABLE 3

PART NUMBER	TRAY
QSFC-1-1-S-F	TY-QSFPC003
QSFC-1-1-S	TY-QSFPC003
QSFC-1-2-S-F	TY-QSFPC003
QSFC-1-4-S-F	TY-QSFPC003
QSFC-1-4-S-N-F	TY-QSFPC003
QSFC-1-1-S-LP-F	TY-QSFPC004
QSFC-1-4-S-LP-F	TY-QSFPC004

PROPRIETARY NOTE
 * THIS DOCUMENT CONTAINS CONFIDENTIAL AND PROPRIETARY INFORMATION AND ALL DESIGN, MANUFACTURING, REPRODUCTION, USE, PATENT RIGHTS AND SALES RIGHTS ARE EXPRESSLY RESERVED BY SAMTEC, INC. THIS DOCUMENT SHALL NOT BE DISCLOSED, IN WHOLE OR PART, TO ANY UNAUTHORIZED PERSON OR ENTITY NOR REPRODUCED, TRANSFERRED OR INCORPORATED IN ANY OTHER PROJECT IN ANY MANNER WITHOUT THE EXPRESS WRITTEN CONSENT OF SAMTEC, INC. *

SHEET SCALE: 1:1



520 PARK EAST BLVD, NEW ALBANY, IN 47150
 PHONE: 812-944-6733 FAX: 812-948-5047
 e-Mail info@SAMTEC.com code 55322

DESCRIPTION: FQSFP CAGE ASSEM

DWG. NO. QSFC-X-X-XX-X

BY: JOE Z 06/20/2017 SHEET 7 OF 7

Looking for pricing, stock, or lifecycle information?

Click below to explore more details on WIN SOURCE:

 [View QSFPC-PF-01 on WIN SOURCE](#)

 [Samtec Inc. Information](#)

Optimize Your Supply Chain with WIN SOURCE Solutions

-  Global Sourcing Solution
-  Obsolete Management
-  Cost Control Management
-  Shortage Management
-  Alternative Solution
-  Excess Inventory Management