



THE DATASHEET OF BCW66HR





BCW66 series

45 V, 800 mA NPN general-purpose transistor

Rev. 1 — 21 April 2017

Product data sheet

1 General description

NPN general-purpose transistors in a small SOT23 (TO-236AB) Surface-Mounted Device (SMD) plastic package.

PNP complements: BCW68F/G/H

2 Features and benefits

- High current
- AEC-Q101 qualified

3 Applications

- General-purpose switching and amplification

4 Quick reference data

Table 1. Quick reference data

Symbol	Parameter	Conditions	Min	Typ	Max	Unit	
V_{CE0}	collector-emitter voltage	open base	-	-	45	V	
I_C	collector current		-	-	800	mA	
I_{CM}	peak collector current	single pulse; $t_p \leq 1$ ms	-	-	1	A	
h_{FE}	DC current gain	$V_{CE} = 1$ V; $I_C = 100$ mA; $T_{amb} = 25$ °C	[1]				
	BCW66F			100	-	250	
	BCW66G			160	-	400	
	BCW66H			250	-	600	

[1] pulsed: $t_p \leq 300$ μ s, $\delta \leq 0.02$

5 Pinning information

Table 2. Pinning

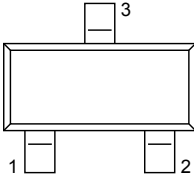
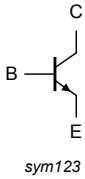
Pin	Symbol	Description	Simplified outline	Graphic symbol
1	B	base		
2	E	emitter		
3	C	collector		

6 Ordering information

Table 3. Ordering information

Type number	Package		Version
	Name	Description	
BCW66F	TO-236AB	plastic surface-mounted package; 3 leads	SOT23
BCW66G			
BCW66H			

7 Marking

Table 4. Marking

Type number	Marking code
BCW66F	^[1] EQ%
BCW66G	^[1] ER%
BCW66H	^[1] ES%

[1] % = placeholder for manufacturing site code

8 Limiting values

Table 5. Limiting values

In accordance with the Absolute Maximum Rating System (IEC 60134).

Symbol	Parameter	Conditions	Min	Max	Unit
V_{CBO}	collector-base voltage	open emitter	-	50	V
V_{CEO}	collector-emitter voltage	open base	-	45	V
V_{EBO}	emitter-base voltage	open collector	-	5	V
I_C	collector current		-	800	mA
I_{CM}	peak collector current	single pulse; $t_p \leq 1$ ms	-	1	A
I_B	base current		-	100	mA

Symbol	Parameter	Conditions	Min	Max	Unit
I_{BM}	peak base current	single pulse; $t_p \leq 1$ ms	-	200	mA
P_{tot}	total power dissipation	$T_{amb} \leq 25$ °C [1]	-	250	mW
T_j	junction temperature		-	150	°C
T_{amb}	ambient temperature		-55	150	°C
T_{stg}	storage temperature		-65	150	°C

[1] Device mounted on an FR4 Printed-Circuit-Board (PCB), single-sided chopper, tin-plated and standard footprint.

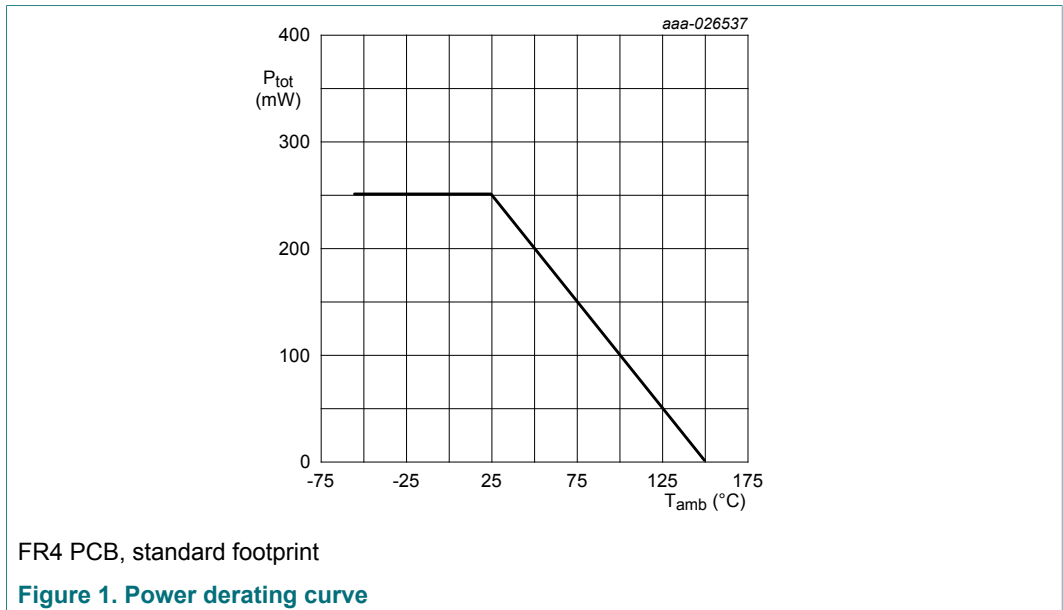

9 Thermal characteristics

Table 6. Thermal characteristics

Symbol	Parameter	Conditions	Min	Typ	Max	Unit
$R_{th(j-a)}$	thermal resistance from junction to ambient	in free air [1]	-	-	500	K/W

[1] Device mounted on an FR4 PCB, single-sided copper, tin-plated and standard footprint.

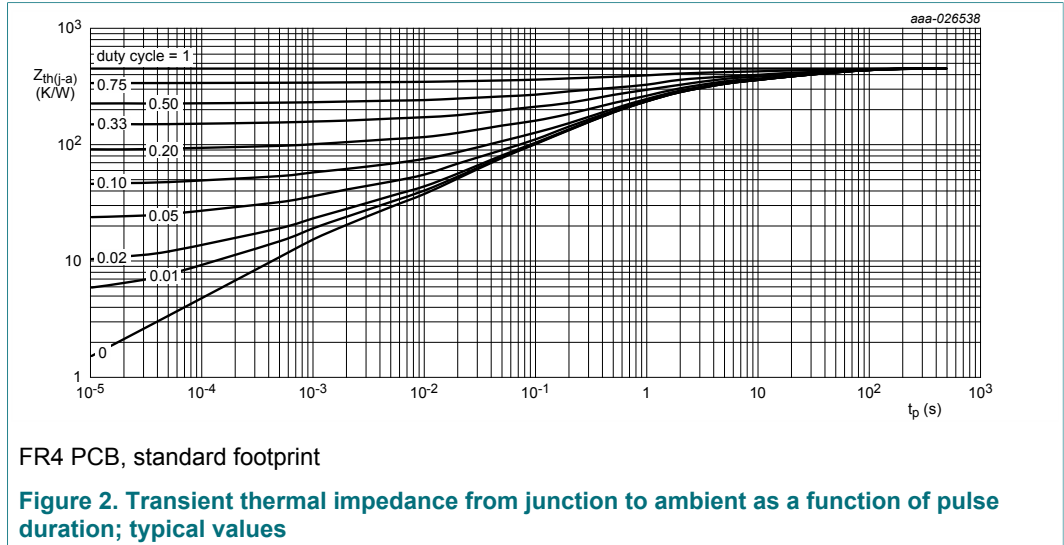

10 Electrical characteristics

Table 7. Electrical characteristics

$T_{amb} = 25\text{ °C}$ unless otherwise specified.

Symbol	Parameter	Conditions	Min	Typ	Max	Unit	
I_{CBO}	collector-base cut-off current	$V_{CB} = 40\text{ V}; I_E = 0\text{ A}$	-	-	20	nA	
		$V_{CB} = 40\text{ V}; I_E = 0\text{ A}; T_j = 150\text{ °C}$	-	-	5	μA	
I_{EBO}	emitter-base cut-off current	$V_{EB} = 5\text{ V}; I_C = 0\text{ A}$	-	-	20	nA	
h_{FE}	DC current gain						
	BCW66F/G/H	$V_{CE} = 1\text{ V}; I_C = 100\text{ }\mu\text{A}$	75	-	-		
	BCW66F/G/H	$V_{CE} = 1\text{ V}; I_C = 1\text{ mA}$	75	-	-		
	BCW66F/G/H	$V_{CE} = 1\text{ V}; I_C = 10\text{ mA}$	75	-	-		
	BCW66F	$V_{CE} = 1\text{ V}; I_C = 100\text{ mA}$	[1]	100	-	250	
	BCW66G		[1]	160	-	400	
	BCW66H		[1]	250	-	630	
BCW66F/G/H	$V_{CE} = 1\text{ V}; I_C = 500\text{ mA}$	[1]	40	-	-		
V_{CEsat}	collector-emitter saturation voltage	$I_C = 100\text{ mA}; I_B = 10\text{ mA}$	[1]	-	-	350	mV
		$I_C = 500\text{ mA}; I_B = 50\text{ mA}$	[1]	-	-	450	mV
V_{BEsat}	base-emitter saturation voltage	$I_C = 100\text{ mA}; I_B = 10\text{ mA}$	[1]	-	-	1.25	V
		$I_C = 500\text{ mA}; I_B = 50\text{ mA}$	[1]	-	-	1.25	V
f_T	transition frequency	$V_{CE} = 5\text{ V}; I_C = 10\text{ mA}; f = 100\text{ MHz}$	100	-	-	MHz	
C_c	collector capacitance	$V_{CB} = 10\text{ V}; I_E = I_e = 0\text{ A}; f = 1\text{ MHz}$	-	3	-	pF	

[1] pulsed; $t_p \leq 300\text{ }\mu\text{s}$; $\delta \leq 0.02$

Table 8.

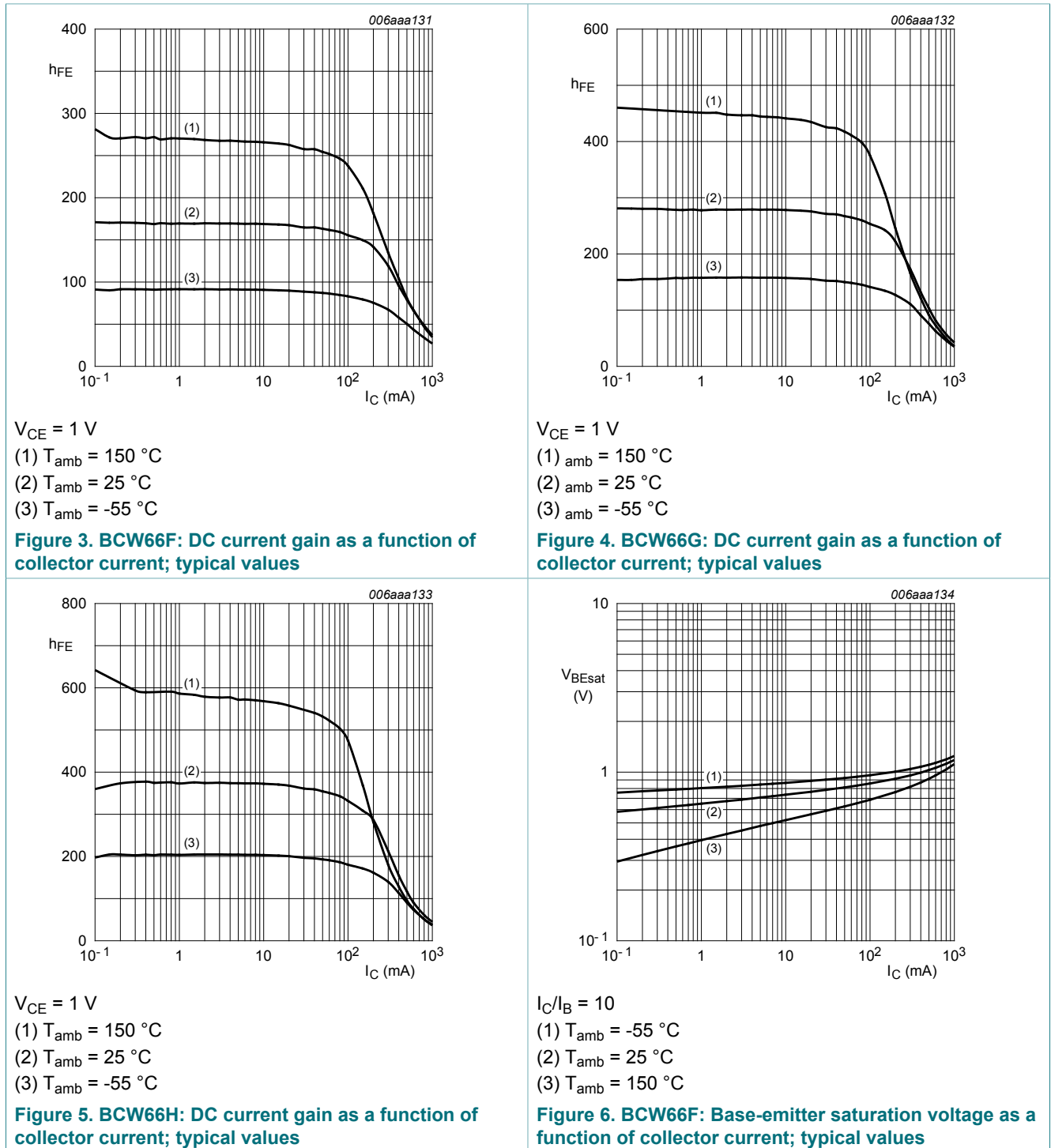

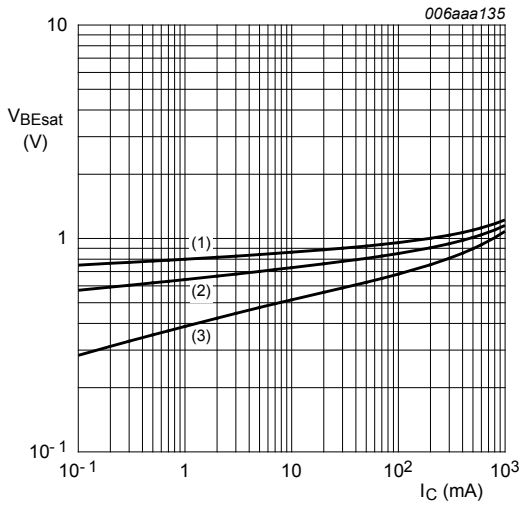

$I_C/I_B = 10$
 (1) $T_{amb} = -55\text{ °C}$
 (2) $T_{amb} = 25\text{ °C}$
 (3) $T_{amb} = 150\text{ °C}$

Figure 7. BCW66G: Base-emitter saturation voltage as a function of collector current; typical values

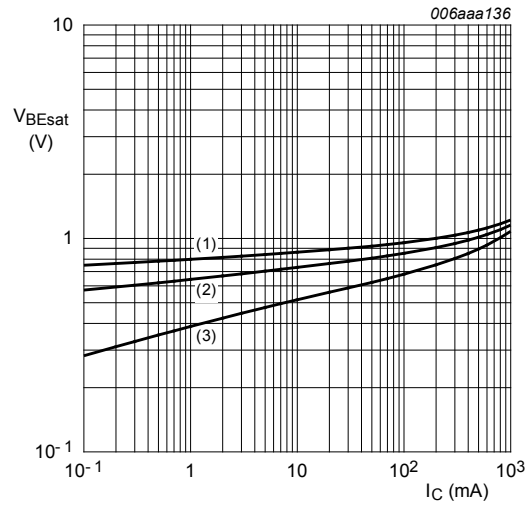

$I_C/I_B = 10$
 (1) $T_{amb} = -55\text{ °C}$
 (2) $T_{amb} = 25\text{ °C}$
 (3) $T_{amb} = 150\text{ °C}$

Figure 8. BCW66H: Base-emitter saturation voltage as a function of collector current; typical values

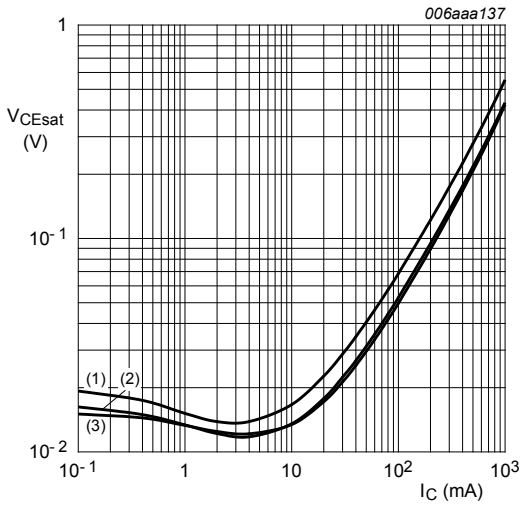

$I_C/I_B = 10$
 (1) $T_{amb} = 150\text{ °C}$
 (2) $T_{amb} = 25\text{ °C}$
 (3) $T_{amb} = -55\text{ °C}$

Figure 9. BCW66F: Collector-emitter saturation voltage as a function of collector current; typical values

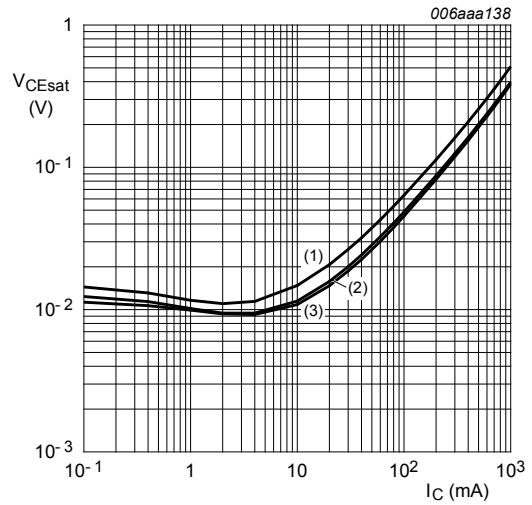

$I_C/I_B = 10$
 (1) $T_{amb} = 150\text{ °C}$
 (2) $T_{amb} = 25\text{ °C}$
 (3) $T_{amb} = -55\text{ °C}$

Figure 10. BCW66G: Collector-emitter saturation voltage as a function of collector current; typical values

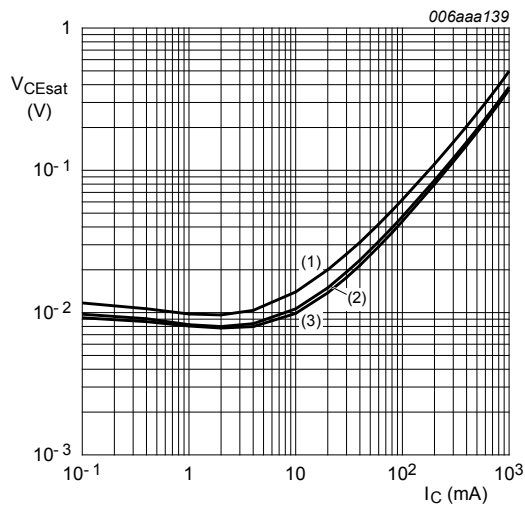

$I_C/I_B = 10$

- (1) $T_{amb} = 150\text{ °C}$
- (2) $T_{amb} = 25\text{ °C}$
- (3) $T_{amb} = -55\text{ °C}$

Figure 11. BCW66H: Collector-emitter saturation voltage as a function of collector current; typical values

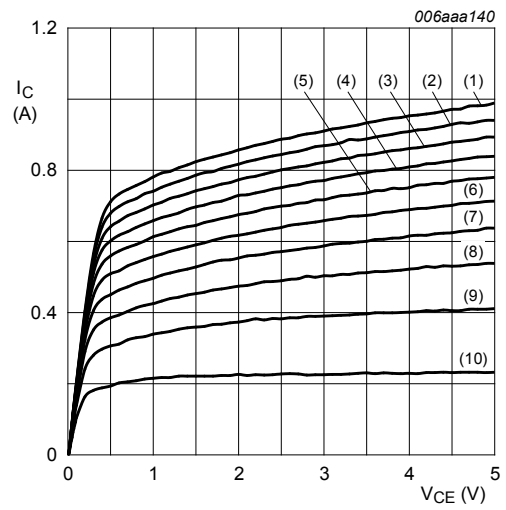

$T_{amb} = 25\text{ °C}$

- (1) $I_B = 16.0\text{ mA}$
- (2) $I_B = 14.4\text{ mA}$
- (3) $I_B = 12.8\text{ mA}$
- (4) $I_B = 11.2\text{ mA}$
- (5) $I_B = 9.6\text{ mA}$
- (6) $I_B = 8.0\text{ mA}$
- (7) $I_B = 6.4\text{ mA}$
- (8) $I_B = 4.8\text{ mA}$
- (9) $I_B = 3.2\text{ mA}$
- (10) $I_B = 1.6\text{ mA}$

Figure 12. BCW66F: Collector current as a function of collector-emitter voltage; typical values

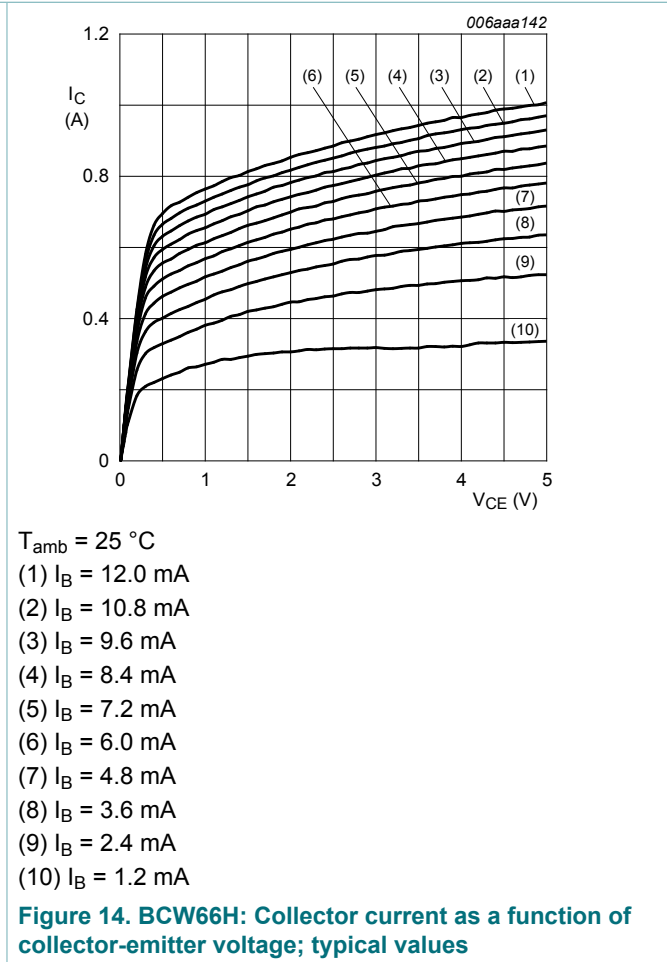
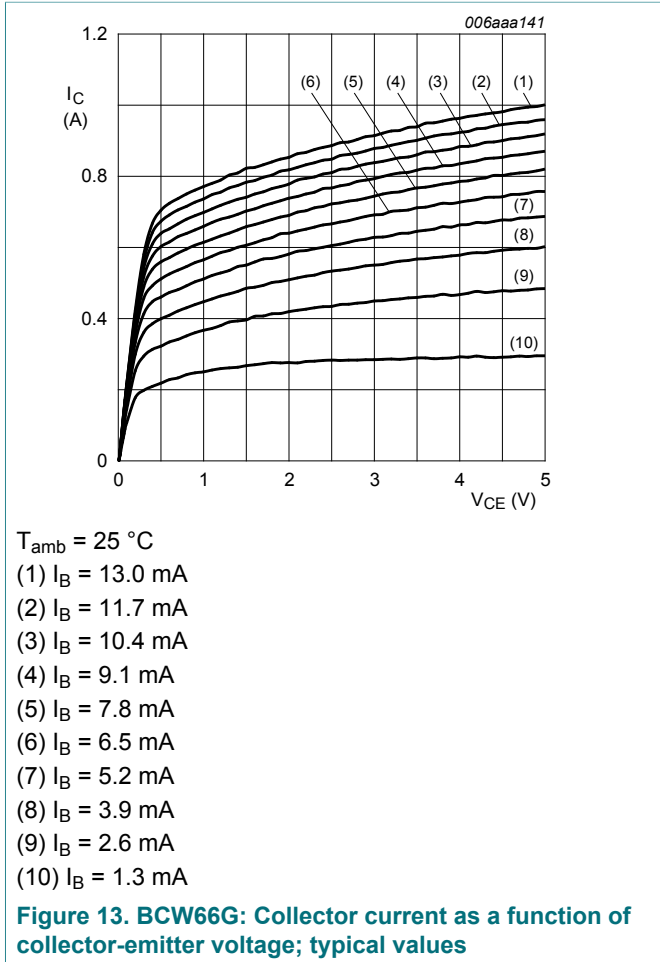

11 Test information

11.1 Quality information

This product has been qualified in accordance with the Automotive Electronics Council (AEC) standard Q101 - Stress test qualification for discrete semiconductors, and is suitable for use in automotive applications.

12 Package outline

Table 9. Package outline

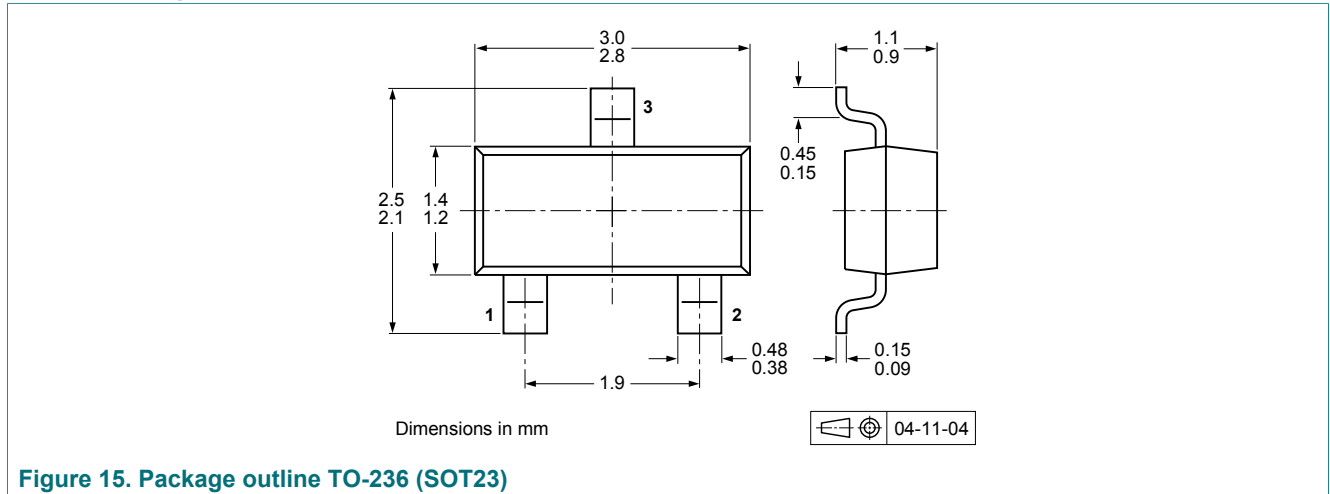

Figure 15. Package outline TO-236 (SOT23)

13 Soldering

Table 10. Soldering

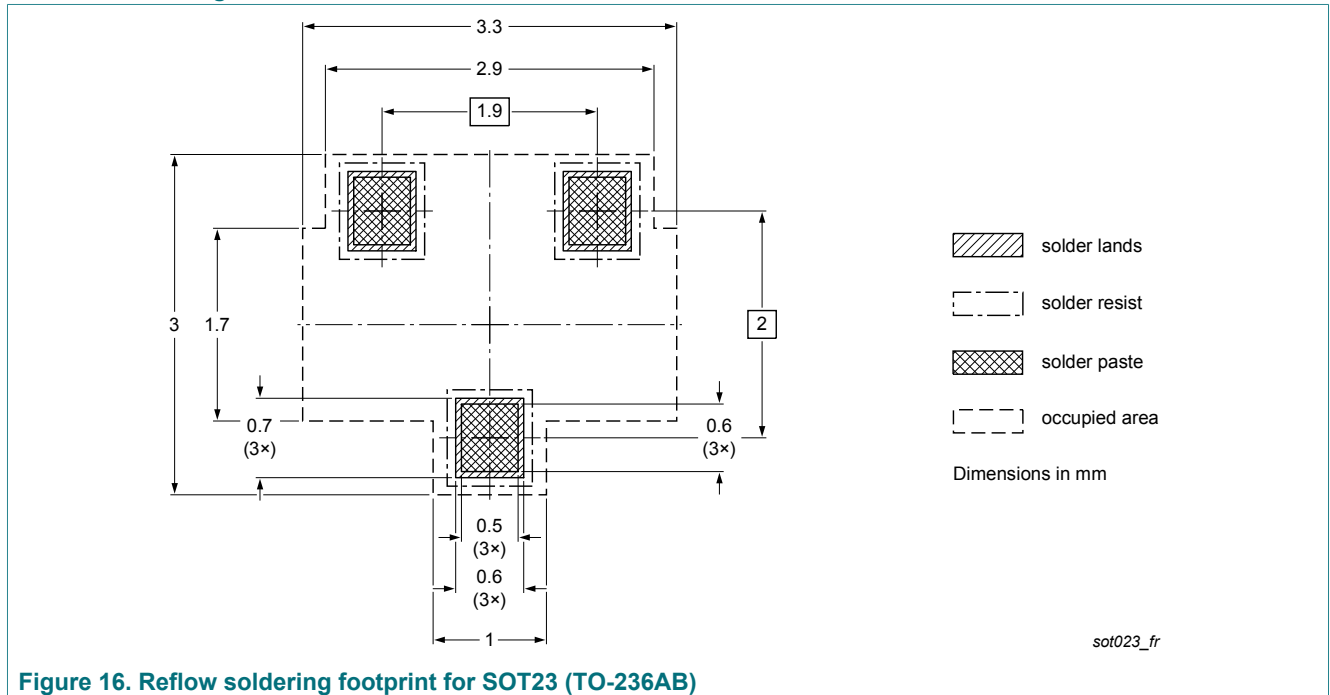
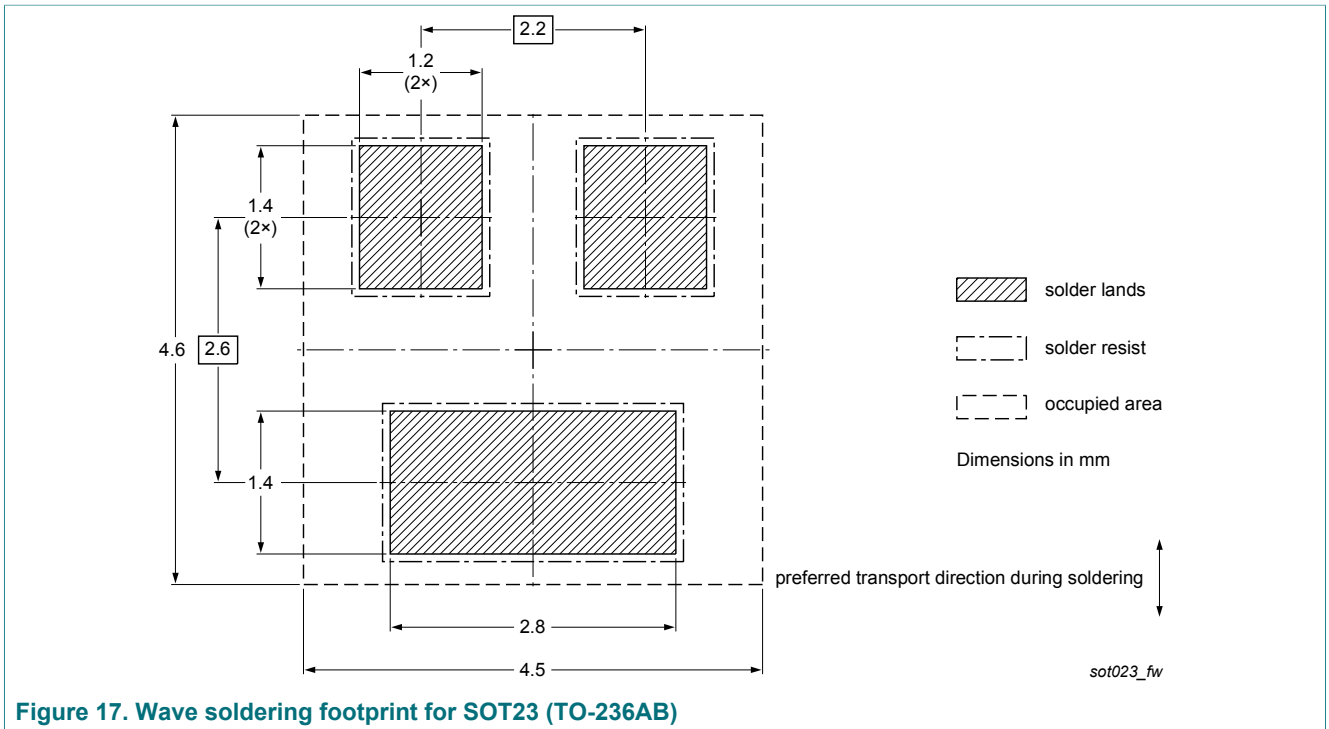

Figure 16. Reflow soldering footprint for SOT23 (TO-236AB)



14 Revision history

Table 11. Revision history

Document ID	Release date	Data sheet status	Change notice	Supersedes
BCW66x_SER v.1	21 April 2017	Product data sheet	-	-

15 Legal information

15.1 Data sheet status

Document status ^{[1][2]}	Product status ^[3]	Definition
Objective [short] data sheet	Development	This document contains data from the objective specification for product development.
Preliminary [short] data sheet	Qualification	This document contains data from the preliminary specification.
Product [short] data sheet	Production	This document contains the product specification.

[1] Please consult the most recently issued document before initiating or completing a design.

[2] The term 'short data sheet' is explained in section "Definitions".

[3] The product status of device(s) described in this document may have changed since this document was published and may differ in case of multiple devices. The latest product status information is available on the Internet at URL <http://www.nexperia.com>.

15.2 Definitions

Draft — The document is a draft version only. The content is still under internal review and subject to formal approval, which may result in modifications or additions. Nexperia does not give any representations or warranties as to the accuracy or completeness of information included herein and shall have no liability for the consequences of use of such information.

Short data sheet — A short data sheet is an extract from a full data sheet with the same product type number(s) and title. A short data sheet is intended for quick reference only and should not be relied upon to contain detailed and full information. For detailed and full information see the relevant full data sheet, which is available on request via the local Nexperia sales office. In case of any inconsistency or conflict with the short data sheet, the full data sheet shall prevail.

Product specification — The information and data provided in a Product data sheet shall define the specification of the product as agreed between Nexperia and its customer, unless Nexperia and customer have explicitly agreed otherwise in writing. In no event however, shall an agreement be valid in which the Nexperia product is deemed to offer functions and qualities beyond those described in the Product data sheet.

15.3 Disclaimers

Limited warranty and liability — Information in this document is believed to be accurate and reliable. However, Nexperia does not give any representations or warranties, expressed or implied, as to the accuracy or completeness of such information and shall have no liability for the consequences of use of such information. Nexperia takes no responsibility for the content in this document if provided by an information source outside of Nexperia. In no event shall Nexperia be liable for any indirect, incidental, punitive, special or consequential damages (including - without limitation - lost profits, lost savings, business interruption, costs related to the removal or replacement of any products or rework charges) whether or not such damages are based on tort (including negligence), warranty, breach of contract or any other legal theory. Notwithstanding any damages that customer might incur for any reason whatsoever, Nexperia's aggregate and cumulative liability towards customer for the products described herein shall be limited in accordance with the Terms and conditions of commercial sale of Nexperia.

Right to make changes — Nexperia reserves the right to make changes to information published in this document, including without limitation specifications and product descriptions, at any time and without notice. This document supersedes and replaces all information supplied prior to the publication hereof.

Applications — Applications that are described herein for any of these products are for illustrative purposes only. Nexperia makes no representation

or warranty that such applications will be suitable for the specified use without further testing or modification. Customers are responsible for the design and operation of their applications and products using Nexperia products, and Nexperia accepts no liability for any assistance with applications or customer product design. It is customer's sole responsibility to determine whether the Nexperia product is suitable and fit for the customer's applications and products planned, as well as for the planned application and use of customer's third party customer(s). Customers should provide appropriate design and operating safeguards to minimize the risks associated with their applications and products. Nexperia does not accept any liability related to any default, damage, costs or problem which is based on any weakness or default in the customer's applications or products, or the application or use by customer's third party customer(s). Customer is responsible for doing all necessary testing for the customer's applications and products using Nexperia products in order to avoid a default of the applications and the products or of the application or use by customer's third party customer(s). Nexperia does not accept any liability in this respect.

Limiting values — Stress above one or more limiting values (as defined in the Absolute Maximum Ratings System of IEC 60134) will cause permanent damage to the device. Limiting values are stress ratings only and (proper) operation of the device at these or any other conditions above those given in the Recommended operating conditions section (if present) or the Characteristics sections of this document is not warranted. Constant or repeated exposure to limiting values will permanently and irreversibly affect the quality and reliability of the device.

Terms and conditions of commercial sale — Nexperia products are sold subject to the general terms and conditions of commercial sale, as published at <http://www.nexperia.com/profile/terms>, unless otherwise agreed in a valid written individual agreement. In case an individual agreement is concluded only the terms and conditions of the respective agreement shall apply. Nexperia hereby expressly objects to applying the customer's general terms and conditions with regard to the purchase of Nexperia products by customer.

No offer to sell or license — Nothing in this document may be interpreted or construed as an offer to sell products that is open for acceptance or the grant, conveyance or implication of any license under any copyrights, patents or other industrial or intellectual property rights.

Suitability for use in automotive applications — This Nexperia product has been qualified for use in automotive applications. Unless otherwise agreed in writing, the product is not designed, authorized or warranted to be suitable for use in life support, life-critical or safety-critical systems or equipment, nor in applications where failure or malfunction of an Nexperia product can reasonably be expected to result in personal injury, death or severe property or environmental damage. Nexperia and its suppliers accept no liability for inclusion and/or use of Nexperia products in such equipment or applications and therefore such inclusion and/or use is at the customer's own risk.

Quick reference data — The Quick reference data is an extract of the product data given in the Limiting values and Characteristics sections of this document, and as such is not complete, exhaustive or legally binding.

Export control — This document as well as the item(s) described herein may be subject to export control regulations. Export might require a prior authorization from competent authorities.

Translations — A non-English (translated) version of a document is for reference only. The English version shall prevail in case of any discrepancy between the translated and English versions.

15.4 Trademarks

Notice: All referenced brands, product names, service names and trademarks are the property of their respective owners.

Tables

Tab. 1.	Quick reference data	1	Tab. 7.	Electrical characteristics	4
Tab. 2.	Pinning	2	Tab. 8.	5
Tab. 3.	Ordering information	2	Tab. 9.	Package outline	9
Tab. 4.	Marking	2	Tab. 10.	Soldering	9
Tab. 5.	Limiting values	2	Tab. 11.	Revision history	10
Tab. 6.	Thermal characteristics	3			

Figures

Fig. 1.	Power derating curve	3	Fig. 9.	BCW66F: Collector-emitter saturation voltage as a function of collector current; typical values	6
Fig. 2.	Transient thermal impedance from junction to ambient as a function of pulse duration; typical values	4	Fig. 10.	BCW66G: Collector-emitter saturation voltage as a function of collector current; typical values	6
Fig. 3.	BCW66F: DC current gain as a function of collector current; typical values	5	Fig. 11.	BCW66H: Collector-emitter saturation voltage as a function of collector current; typical values	7
Fig. 4.	BCW66G: DC current gain as a function of collector current; typical values	5	Fig. 12.	BCW66F: Collector current as a function of collector-emitter voltage; typical values	7
Fig. 5.	BCW66H: DC current gain as a function of collector current; typical values	5	Fig. 13.	BCW66G: Collector current as a function of collector-emitter voltage; typical values	8
Fig. 6.	BCW66F: Base-emitter saturation voltage as a function of collector current; typical values	5	Fig. 14.	BCW66H: Collector current as a function of collector-emitter voltage; typical values	8
Fig. 7.	BCW66G: Base-emitter saturation voltage as a function of collector current; typical values	6	Fig. 15.	Package outline TO-236 (SOT23)	9
Fig. 8.	BCW66H: Base-emitter saturation voltage as a function of collector current; typical values	6	Fig. 16.	Reflow soldering footprint for SOT23 (TO-236AB)	9
			Fig. 17.	Wave soldering footprint for SOT23 (TO-236AB)	10

Contents

1	General description	1
2	Features and benefits	1
3	Applications	1
4	Quick reference data	1
5	Pinning information	2
6	Ordering information	2
7	Marking	2
8	Limiting values	2
9	Thermal characteristics	3
10	Electrical characteristics	4
11	Test information	8
11.1	Quality information	8
12	Package outline	9
13	Soldering	9
14	Revision history	10
15	Legal information	11

Please be aware that important notices concerning this document and the product(s) described herein, have been included in section 'Legal information'.

© Nexperia B.V. 2017.

All rights reserved.



For more information, please visit: <http://www.nexperia.com>

For sales office addresses, please send an email to: salesaddresses@nexperia.com

Date of release: 21 April 2017
Document identifier: BCW66x_SER

Looking for pricing, stock, or lifecycle information?

Click below to explore more details on WIN SOURCE:

-  [View BCW66HR on WIN SOURCE](#)
-  [Nexperia USA Inc. Information](#)

Optimize Your Supply Chain with WIN SOURCE Solutions

-  Global Sourcing Solution
-  Obsolete Management
-  Cost Control Management
-  Shortage Management
-  Alternative Solution
-  Excess Inventory Management