



**THE DATASHEET OF
LT6657BHMS8-4.096#PBF**



FEATURES

- **Low Drift**
 - **A Grade: 1.5ppm/°C Max**
 - **B Grade: 3ppm/°C Max**
- **Low Noise:**
 - **0.5ppm_{P-P} (0.1Hz to 10Hz)**
 - **0.8ppm_{RMS} (10Hz to 1kHz)**
- **Wide Supply Range to 40V**
- **Sources and Sinks 10mA Min**
- Line Regulation: 0.2ppm/V
- Load Regulation: 2μV/mA
- Reverse Supply Protection
- Reverse Output Protection
- Low Power Shutdown: <4μA Max
- 1.5V Min Supply for 1.25V Option
- Thermal Protection
- Can Operate in Shunt Mode
- Configurable as a Negative Reference
- Available Output Voltage Options: 1.25V, 2.5V, 3V, 4.096V, 5V
- MSOP-8 Package

APPLICATIONS

- High Temperature Industrial
- High Resolution Data Acquisition Systems
- Instrumentation and Process Control
- Automotive Control and Monitoring
- Medical Equipment
- Shunt and Negative Voltage References

DESCRIPTION

The LT[®]6657 is a precision voltage reference that combines robust operating characteristics with extremely low drift and low noise. With advanced curvature compensation, this bandgap reference achieves 1.5ppm/°C drift with predictable temperature behavior, and an initial voltage accuracy of 0.1%. It also offers 0.5ppm_{P-P} noise and very low temperature cycling hysteresis.

The LT6657 is a low dropout reference that can be powered from as little as 50mV above the output voltage, up to 40V. The buffered output supports ±10mA of output drive with low output impedance and precise load regulation. The high sink current capability allows operation as a negative voltage reference with the same precision as a positive reference. This part is safe under reverse battery conditions, and includes current protection when the output is short-circuited and thermal shutdown for overload conditions. A shutdown is included to allow power reduction while enabling a quick turn-on.

The LT6657 is fully specified over the temperature range of –40°C to 125°C. It is available in the 8-lead MSOP package.

LT, LT, LTC, LTM, Linear Technology and the Linear logo are registered trademarks of Linear Technology Corporation. All other trademarks are the property of their respective owners.

TYPICAL APPLICATION

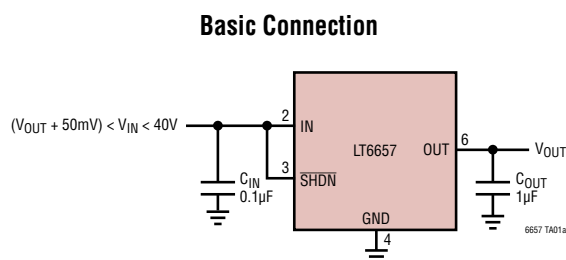

Output Voltage Temperature Drift

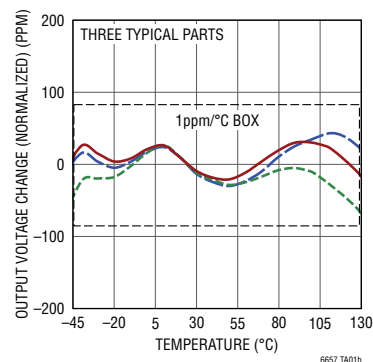

ABSOLUTE MAXIMUM RATINGS

(Note 1)

Input Voltage V_{IN} (to GND)	-40V to 40V
Shutdown Voltage $SHDN$	-20V to 40V
Output Voltage V_{OUT}	-3V to 30V
Input-to-Output Differential Voltage (Note 2)	$\pm 40V$
Output Short-Circuit Duration	Indefinite
Operating Junction Temperature	
Range	-40°C to 150°C
Storage Temperature Range	-65°C to 150°C
Lead Temperature (Soldering 10 sec)	
(Note 3)	300°C

PIN CONFIGURATION

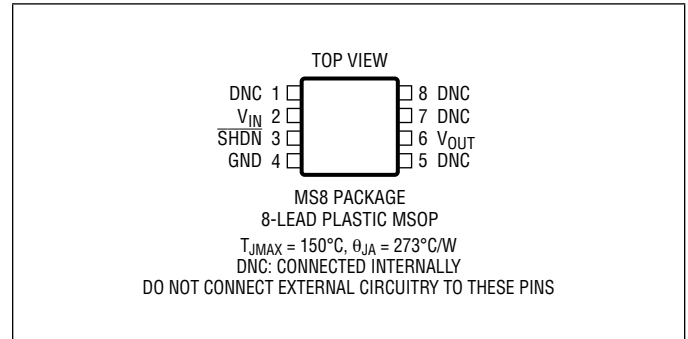

ORDER INFORMATION <http://www.linear.com/product/LT6657#orderinfo>

TUBE	TAPE AND REEL	PART MARKING*	PACKAGE DESCRIPTION	SPECIFIED TEMPERATURE RANGE
LT6657AHMS8-1.25#PBF	LT6657AHMS8-1.25#TRPBF	LTGYR	8-Lead Plastic MSOP	-40°C to 125°C
LT6657BHMS8-1.25#PBF	LT6657BHMS8-1.25#TRPBF	LTGYR	8-Lead Plastic MSOP	-40°C to 125°C
LT6657AHMS8-2.5#PBF	LT6657AHMS8-2.5#TRPBF	LTGKN	8-Lead Plastic MSOP	-40°C to 125°C
LT6657BHMS8-2.5#PBF	LT6657BHMS8-2.5#TRPBF	LTGKN	8-Lead Plastic MSOP	-40°C to 125°C
LT6657AHMS8-3#PBF	LT6657AHMS8-3#TRPBF	LTGYG	8-Lead Plastic MSOP	-40°C to 125°C
LT6657BHMS8-3#PBF	LT6657BHMS8-3#TRPBF	LTGYG	8-Lead Plastic MSOP	-40°C to 125°C
LT6657AHMS8-4.096#PBF	LT6657AHMS8-4.096#TRPBF	LTHCJ	8-Lead Plastic MSOP	-40°C to 125°C
LT6657BHMS8-4.096#PBF	LT6657BHMS8-4.096#TRPBF	LTHCJ	8-Lead Plastic MSOP	-40°C to 125°C
LT6657AHMS8-5#PBF	LT6657AHMS8-5#TRPBF	LTGYH	8-Lead Plastic MSOP	-40°C to 125°C
LT6657BHMS8-5#PBF	LT6657BHMS8-5#TRPBF	LTGYH	8-Lead Plastic MSOP	-40°C to 125°C

*Temperature grades are identified by a label on the shipping container.

Consult LTC Marketing for parts specified with wider operating temperature ranges. Parts ending with PBF are RoHS and WEEE compliant.

For more information on lead free part marking, go to: <http://www.linear.com/leadfree/>

For more information on tape and reel specifications, go to: <http://www.linear.com/tapeandree/>. Some packages are available in 500 unit reels through designated sales channels with #TRMPBF suffix.

AVAILABLE OPTIONS

OUTPUT VOLTAGE	INITIAL ACCURACY	TEMPERATURE COEFFICIENT	ORDER PART NUMBER**	SPECIFIED TEMPERATURE RANGE
1.25V	0.1% 0.1%	1.5ppm/°C 3ppm/°C	LT6657AHMS8-1.25 LT6657BHMS8-1.25	-40°C to 125°C -40°C to 125°C
2.5V	0.1% 0.1%	1.5ppm/°C 3ppm/°C	LT6657AHMS8-2.5 LT6657BHMS8-2.5	-40°C to 125°C -40°C to 125°C
3V	0.1% 0.1%	1.5ppm/°C 3ppm/°C	LT6657AHMS8-3 LT6657BHMS8-3	-40°C to 125°C -40°C to 125°C
4.096V	0.1% 0.1%	1.5ppm/°C 3ppm/°C	LT6657AHMS8-4.096 LT6657BHMS8-4.096	-40°C to 125°C -40°C to 125°C
5V	0.1% 0.1%	1.5ppm/°C 3ppm/°C	LT6657AHMS8-5 LT6657BHMS8-5	-40°C to 125°C -40°C to 125°C

** See the Order Information section for complete part number listing.

ELECTRICAL CHARACTERISTICS

The ● denotes the specifications which apply over the full operating temperature range, otherwise specifications are at $T_A = 25^\circ\text{C}$. The test conditions are $V_{IN} = V_{OUT} + 0.5\text{V}$, $V_{SHDN} = 1.6\text{V}$, $I_{OUT} = 0$, $C_{IN} = 0.1\mu\text{F}$, $C_{OUT} = 1\mu\text{F}$. For LT6657-1.25 $V_{SHDN} = 1.45\text{V}$, $C_{IN} = 1\mu\text{F}$, $C_{OUT} = 2.7\mu\text{F}$, unless otherwise noted.

PARAMETER	CONDITIONS		MIN	TYP	MAX	UNITS
Output Voltage Accuracy			-0.1	0	0.1	%
Output Voltage Temperature Coefficient (Note 4)	LT6657A	●		0.5	1.5	ppm/°C
	LT6657B	●		1	3	ppm/°C
Line Regulation (Note 5)	$V_{OUT} + 0.5\text{V} \leq V_{IN} \leq 40\text{V}$			0.2	2	ppm/V
		●			4	ppm/V
Load Regulation (Note 5)	$I_{OUT} \text{ (Source)} = 10\text{mA}$			2	6	$\mu\text{V}/\text{mA}$
		●			10	$\mu\text{V}/\text{mA}$
	$I_{OUT} \text{ (Sink)} = 10\text{mA}$			3	8	$\mu\text{V}/\text{mA}$
		●			15	$\mu\text{V}/\text{mA}$
	Shunt Configuration All, Except LT6657-1.25 V_{OUT} Is Shorted to V_{IN} $I_{SHUNT} 2.5$ to 11mA			3	15	$\mu\text{V}/\text{mA}$
Minimum $V_{IN} - V_{OUT}$ All, Except LT6657-1.25	$V_{IN} - V_{OUT}$, $\Delta V_{OUT} = 0.1\%$	$I_{OUT} = 0\text{mA}$	●	20	50	mV
					70	mV
		$I_{OUT} \text{ (Source)} = 1\text{mA}$	●	65	100	mV
					140	mV
		$I_{OUT} \text{ (Source)} = 10\text{mA}$	●	330	450	mV
					500	mV
		$I_{OUT} \text{ (Sink)} = 10\text{mA}$	●	-230	-150	mV
					-50	mV
LT6657-1.25V	$V_{IN} - V_{OUT}$, $\Delta V_{OUT} = 0.1\%$	$I_{OUT} = 0\text{mA}$	●	120	200	mV
					250	mV
		$I_{OUT} \text{ (Source)} = 1\text{mA}$	●	120	200	mV
					250	mV
	$I_{OUT} \text{ (Source)} = 10\text{mA}$	●	330	450	mV	
				500	mV	
	$I_{OUT} \text{ (Sink)} = 10\text{mA}$	●	120	200	mV	
				250	mV	

ELECTRICAL CHARACTERISTICS

The ● denotes the specifications which apply over the full operating temperature range, otherwise specifications are at $T_A = 25^\circ\text{C}$. The test conditions are $V_{IN} = V_{OUT} + 0.5\text{V}$, $V_{\overline{\text{SHDN}}} = 1.6\text{V}$, $I_{OUT} = 0$, $C_{IN} = 0.1\mu\text{F}$, $C_{OUT} = 1\mu\text{F}$. For LT6657-1.25 $V_{\overline{\text{SHDN}}} = 1.45\text{V}$, $C_{IN} = 1\mu\text{F}$, $C_{OUT} = 2.7\mu\text{F}$, unless otherwise noted.

PARAMETER	CONDITIONS	MIN	TYP	MAX	UNITS
Shutdown Pin ($\overline{\text{SHDN}}$) All, Except LT6657-1.25	Logic High Input Voltage	●	1.6		V
	Logic High Input Current, $\overline{\text{SHDN}} = 1.6\text{V}$	●		0.7	μV
	Logic Low Input Voltage	●			V
	Logic Low Input Current, $\overline{\text{SHDN}} = 0.8\text{V}$	●		0.2	μV
LT6657-1.25V	Logic High Input Voltage	●	1.45		V
	Logic High Input Current, $\overline{\text{SHDN}} = 1.45\text{V}$	●		0.5	μV
	Logic Low Input Voltage	●			V
	Logic Low Input Current, $\overline{\text{SHDN}} = 0.8\text{V}$	●		0.05	μV
Supply Current in Shutdown	$\overline{\text{SHDN}} = 0.4\text{V}$ $\overline{\text{SHDN}} = 0.8\text{V}$	●		0.01	μA
		●		2.0	μA
Supply Current	No Load	●		1.2	mA
		●		1.8	mA
Output Short-Circuit Current	Short V_{OUT} to GND Short V_{OUT} to V_{IN}			15	mA
				16	mA
Output Voltage Noise (Note 6)	0.1Hz $\leq f \leq$ 10Hz 10Hz $\leq f \leq$ 1kHz			0.5	$\text{ppm}_{\text{P-P}}$
				0.8	ppm_{RMS}
Turn-On Time	0.1% Settling, $C_{OUT} = 1\mu\text{F}$			180	μsec
Long-Term Drift of Output Voltage (Note 7)				30	$\text{ppm}/\sqrt{\text{kHr}}$
Hysteresis (Note 8)	$\Delta T = 0^\circ\text{C}$ to 50°C $\Delta T = 0^\circ\text{C}$ to 70°C $\Delta T = -40^\circ\text{C}$ to 85°C $\Delta T = -40^\circ\text{C}$ to 125°C $\Delta T = -55^\circ\text{C}$ to 125°C			20	ppm
				24	ppm
				30	ppm
				35	ppm
				40	ppm

Note 1: Stresses beyond those listed under Absolute Maximum Ratings may cause permanent damage to the device. Exposure to any Absolute Maximum Rating condition for extended periods may affect device reliability and lifetime.

Note 2: With V_{IN} at 40V, V_{OUT} may not be pulled below 0V. The total V_{IN} to V_{OUT} differential voltage must not exceed $\pm 40\text{V}$.

Note 3: The stated temperature is typical for soldering of the leads during manual rework. For detailed IR reflow recommendations, refer to the Application information section.

Note 4: Temperature coefficient is measured by dividing the maximum change in output voltage by the specified temperature range.

Note 5: Line and load regulation are measured on a pulse basis for specified input voltage or load current ranges. Output voltage change due to die temperature change must be taken into account separately.

Note 6: Peak-to-peak noise is measured with a 2-pole highpass filter at 0.1Hz and 3-pole lowpass filter at 10Hz. The unit is enclosed in a still-air environment to eliminate thermocouple effects on the leads, and the test time is 10 seconds. Due to the statistical nature of noise, repeating noise measurements will yield larger and smaller peak values in a given measurement interval. By repeating the measurement for 1000 intervals, each 10 seconds long, it is shown that there are time intervals during which the noise is higher than in a typical single interval, as predicted by

statistical theory. In general, typical values are considered to be those for which at least 50% of the units may be expected to perform similarly or better. For the 1000 interval test, a typical unit will exhibit noise that is less than the typical value listed in the Electrical Characteristics table in more than 50% of its measurement intervals. See Application Note 124 for noise testing details. RMS noise is measured with a spectrum analyzer in a shielded environment.

Note 7: Long term stability typically has a logarithmic characteristic and therefore change after 1000 hours tend to be much smaller than before that time. Total drift in the second thousand hours is normally less than one third of the first thousand hours with a continuing trend toward reduced drift with time. Long-term stability will also be affected by differential stresses between the IC and the board material created during board assembly.

Note 8: Hysteresis in output voltage is created by mechanical stress that depends on whether the IC was previously at a different temperature. Output voltage is always measured at 25°C , but the IC is cycled 25°C to cold to 25°C , or 25°C to hot to 25°C before successive measurements. Hysteresis measures the maximum output change for the averages of three hot or cold temperature cycles, preconditioned by one cold and one hot cycles. For instruments that are stored at well controlled temperatures (within 30 degrees of the operational temperature), hysteresis is usually not a significant error source.

TYPICAL PERFORMANCE CHARACTERISTICS The test conditions are $T_A = 25^\circ\text{C}$, $V_{IN} = V_{OUT} + 0.5\text{V}$, $V_{SHDN} = 1.6\text{V}$, $I_{OUT} = 0$, $C_{IN} = 0.1\mu\text{F}$, $C_{OUT} = 1\mu\text{F}$. For LT6657-1.25 $V_{SHDN} = 1.45\text{V}$, $C_{IN} = 1\mu\text{F}$, $C_{OUT} = 2.7\mu\text{F}$, unless otherwise noted.

1.25V Output Voltage Temperature Drift

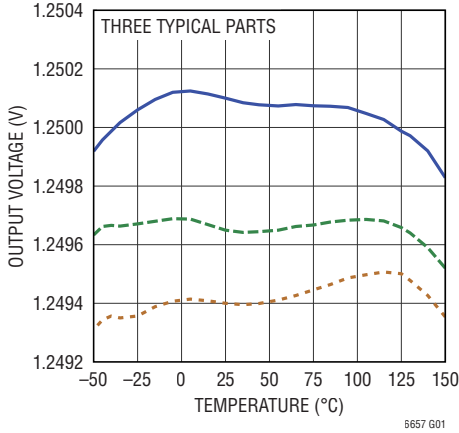

1.25V Low Frequency 0.1Hz to 10Hz Noise

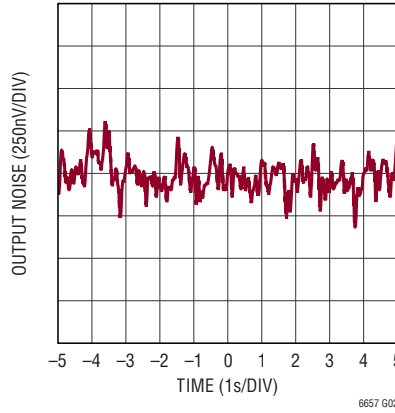

1.25V Output Voltage Noise Spectrum

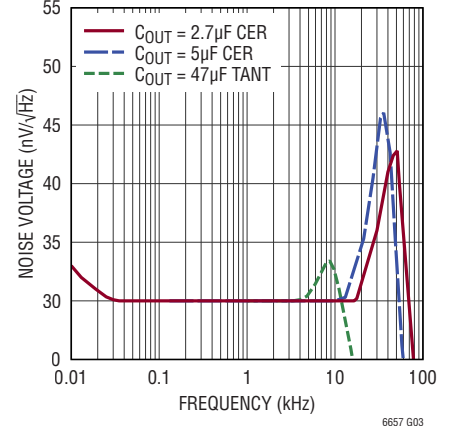

1.25V Integrated Noise 10Hz to 10kHz

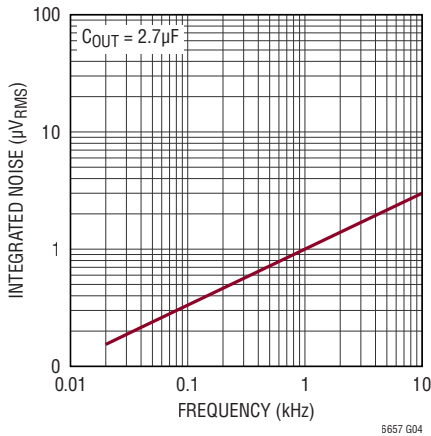

1.25V Supply Current vs Input Voltage

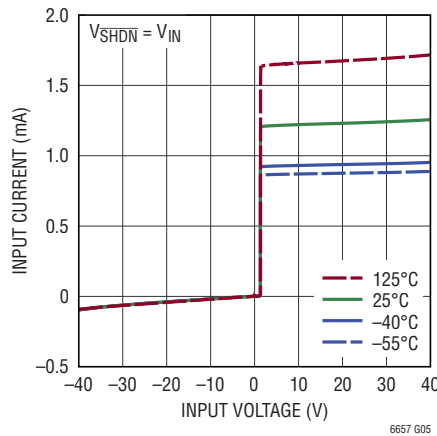

1.25V Line Regulation

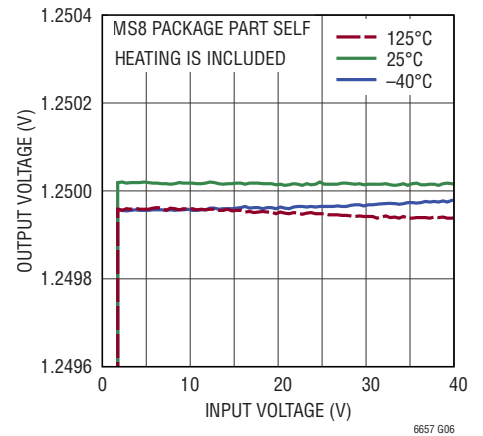

1.25V Load Regulation (Sourcing)

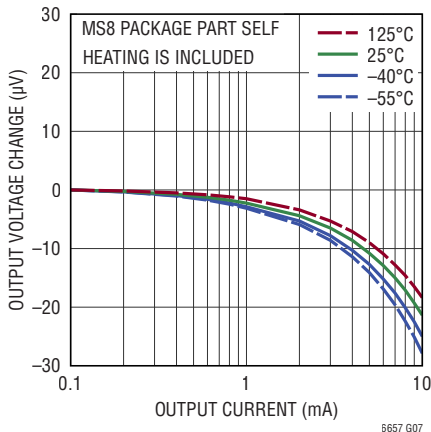

1.25V Load Regulation (Sourcing)

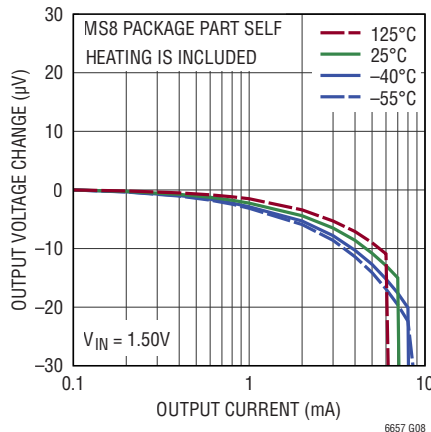

1.25V Load Regulation (Sinking)

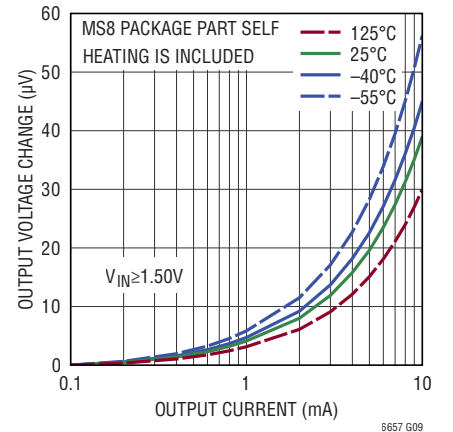

TYPICAL PERFORMANCE CHARACTERISTICS The test conditions are $T_A = 25^\circ\text{C}$, $V_{IN} = V_{OUT} + 0.5\text{V}$, $V_{SHDN} = 1.6\text{V}$, $I_{OUT} = 0$, $C_{IN} = 0.1\mu\text{F}$, $C_{OUT} = 1\mu\text{F}$. For LT6657-1.25 $V_{SHDN} = 1.45\text{V}$, $C_{IN} = 1\mu\text{F}$, $C_{OUT} = 2.7\mu\text{F}$, unless otherwise noted.

1.25V Minimum V_{IN} to V_{OUT} Differential (Sourcing)

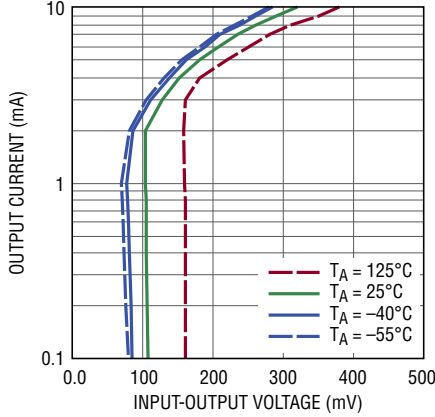

6657 G10

1.25V Minimum V_{IN} to V_{OUT} Differential (Sinking)

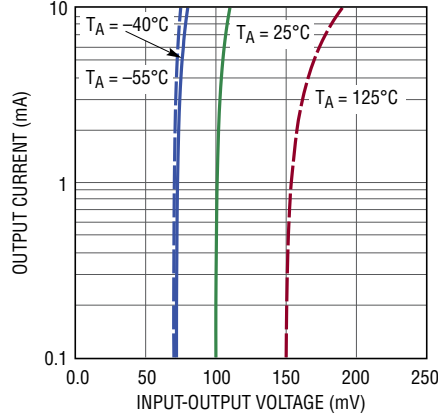

6657 G11

1.25V Output Impedance vs Frequency

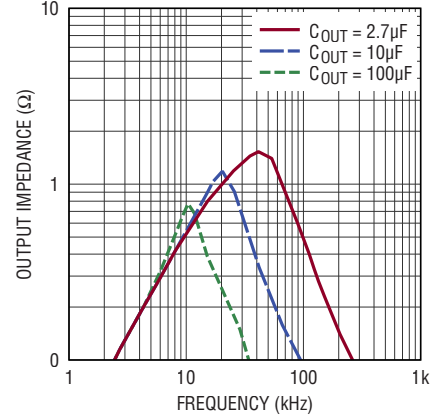

6657 G12

Output Accuracy Histogram

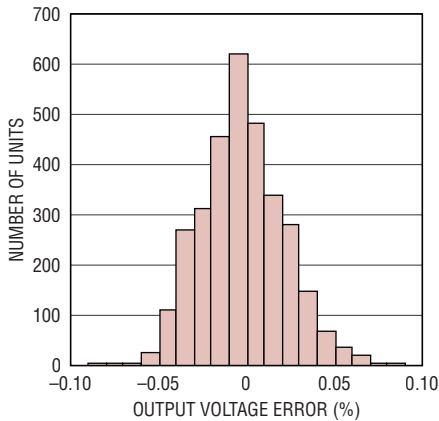

6657 G13

2.5V Output Voltage Temperature Drift

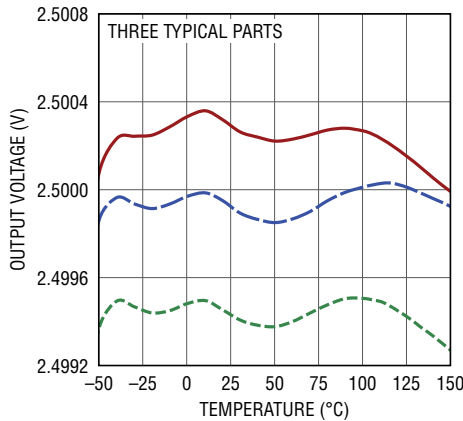

6657 G14

2.5V Low Frequency 0.1Hz to 10Hz Noise

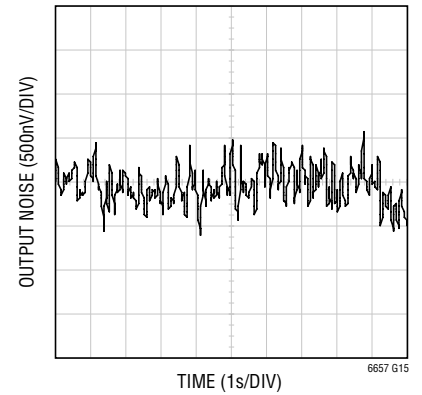

6657 G15

2.5V Output Voltage Noise Spectrum

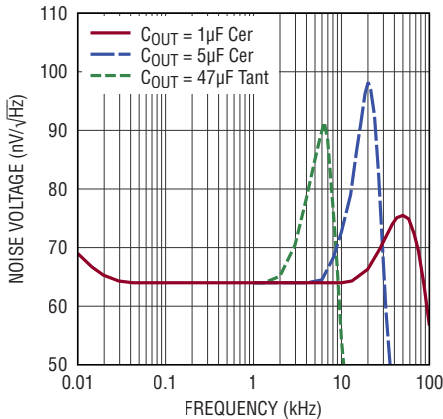

6657 G16

2.5V Integrated Noise 10Hz to 10kHz

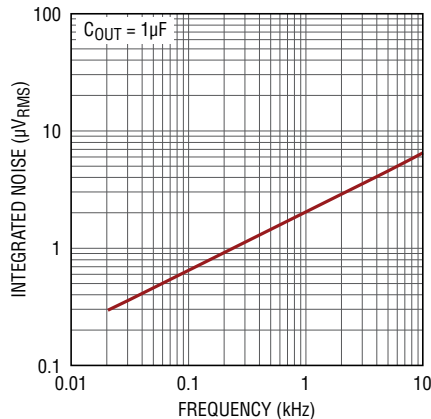

6657 G17

2.5V Supply Current vs Input Voltage

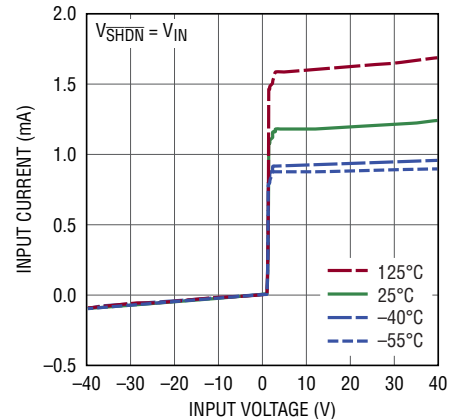

6657 G18

6657fd

TYPICAL PERFORMANCE CHARACTERISTICS The test conditions are $T_A = 25^\circ\text{C}$, $V_{IN} = V_{OUT} + 0.5\text{V}$, $V_{SHDN} = 1.6\text{V}$, $I_{OUT} = 0$, $C_{IN} = 0.1\mu\text{F}$, $C_{OUT} = 1\mu\text{F}$. For LT6657-1.25 $V_{SHDN} = 1.45\text{V}$, $C_{IN} = 1\mu\text{F}$, $C_{OUT} = 2.7\mu\text{F}$, unless otherwise noted.

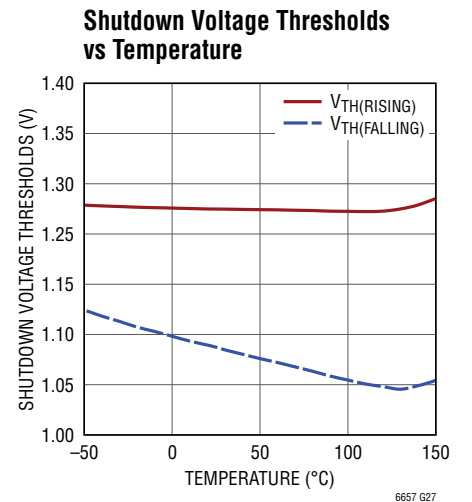
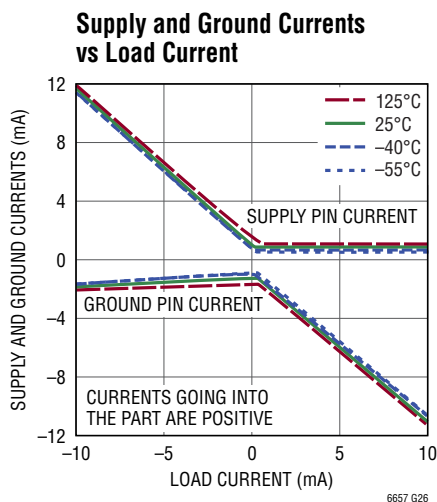
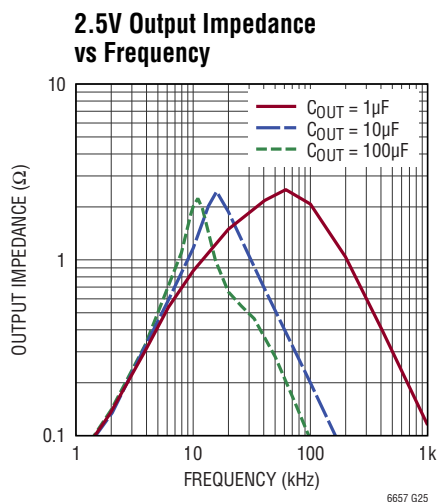
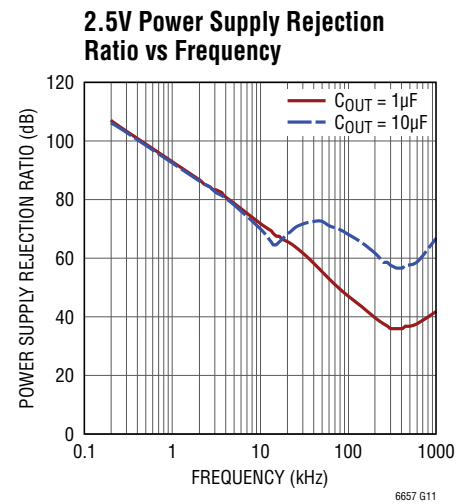
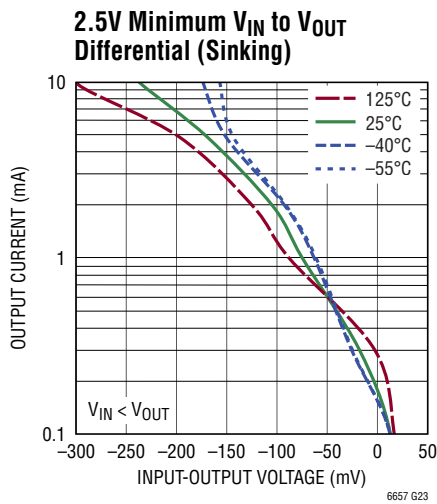
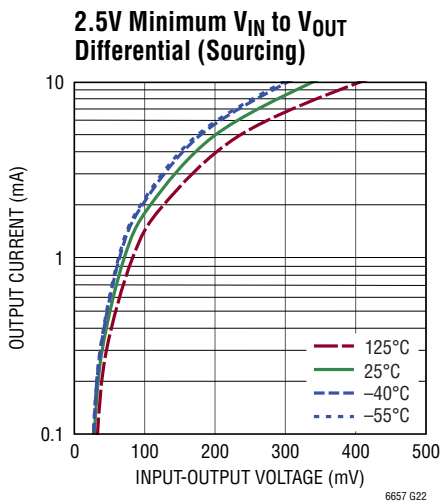
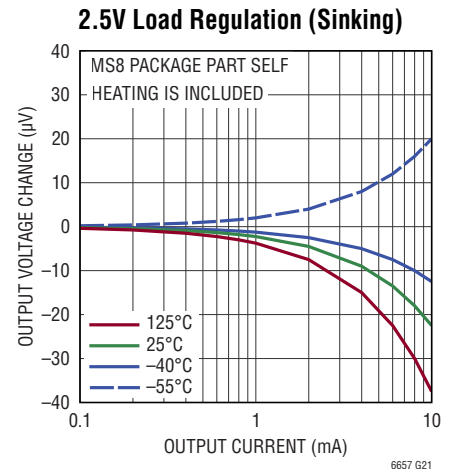
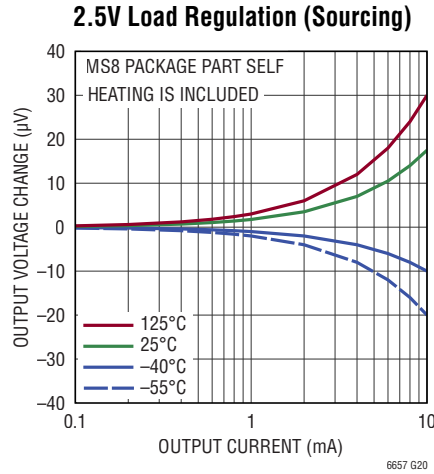
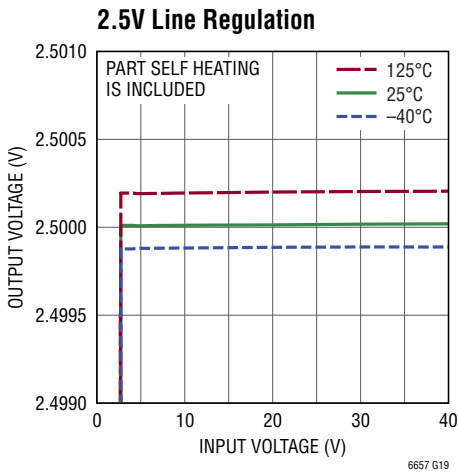

TYPICAL PERFORMANCE CHARACTERISTICS The test conditions are $T_A = 25^\circ\text{C}$, $V_{IN} = V_{OUT} + 0.5\text{V}$, $V_{SHDN} = 1.6\text{V}$, $I_{OUT} = 0$, $C_{IN} = 0.1\mu\text{F}$, $C_{OUT} = 1\mu\text{F}$. For LT6657-1.25 $V_{SHDN} = 1.45\text{V}$, $C_{IN} = 1\mu\text{F}$, $C_{OUT} = 2.7\mu\text{F}$, unless otherwise noted.

Shutdown Pin Current vs Shutdown Voltage

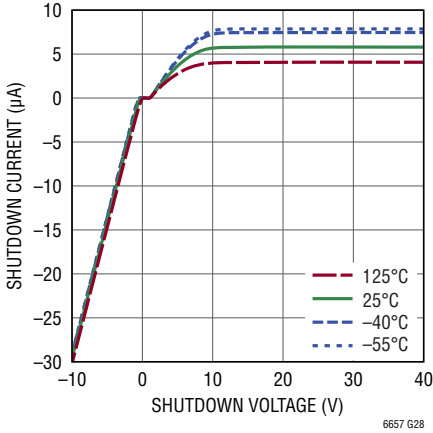

2.5V Supply Current in Shutdown vs Input Voltage

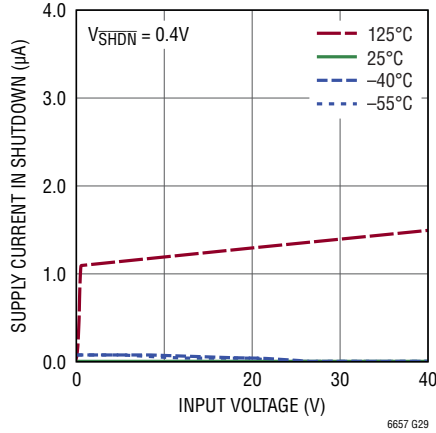

5V Output Voltage Temperature Drift

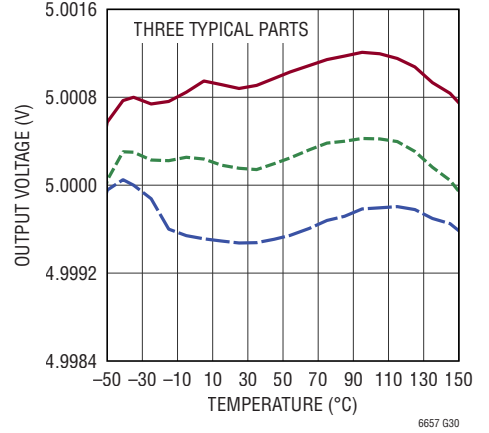

5V Low Frequency 0.1Hz to 10Hz Noise

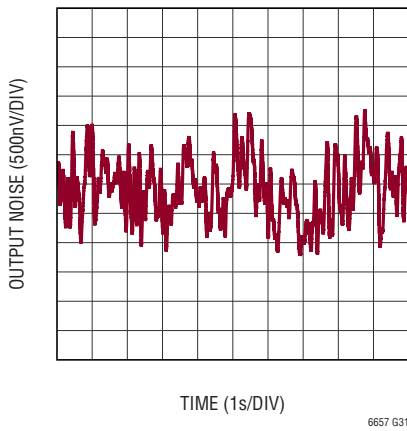

5V Output Voltage Noise Spectrum

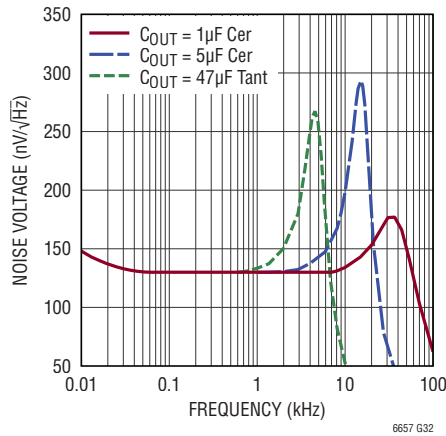

5V Integrated Noise 10Hz to 10kHz

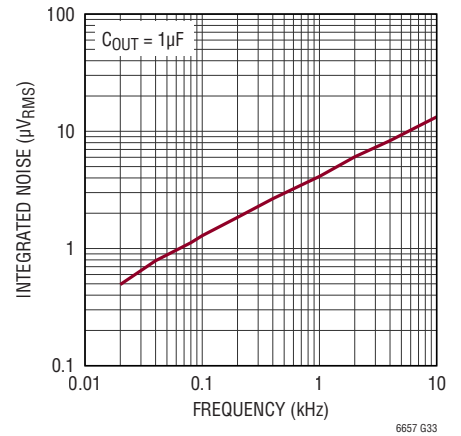

5V Supply Current vs Input Voltage

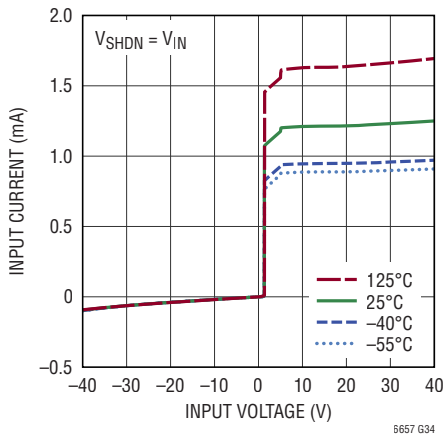

5V Line Regulation

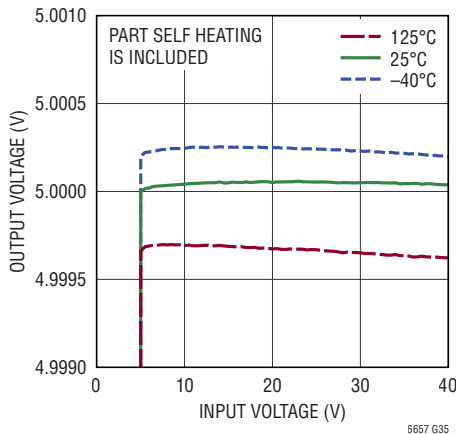

5V Load Regulation (Sourcing)

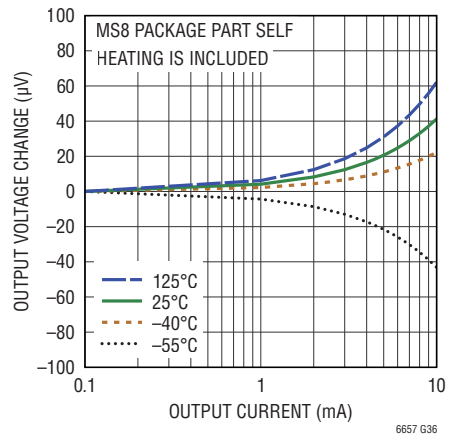

TYPICAL PERFORMANCE CHARACTERISTICS The test conditions are $T_A = 25^\circ\text{C}$, $V_{IN} = V_{OUT} + 0.5\text{V}$, $V_{SHDN} = 1.6\text{V}$, $I_{OUT} = 0$, $C_{IN} = 0.1\mu\text{F}$, $C_{OUT} = 1\mu\text{F}$. For LT6657-1.25 $V_{SHDN} = 1.45\text{V}$, $C_{IN} = 1\mu\text{F}$, $C_{OUT} = 2.7\mu\text{F}$, unless otherwise noted.

5V Load Regulation (Sinking)

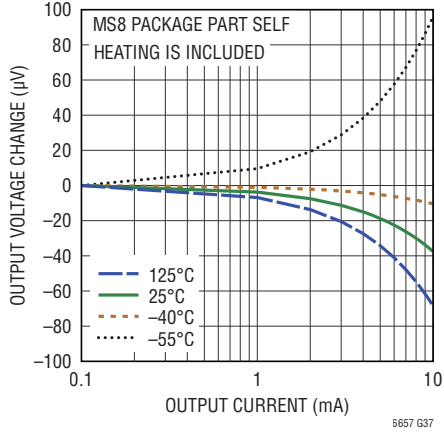

5V Minimum V_{IN} to V_{OUT} Differential (Sourcing)

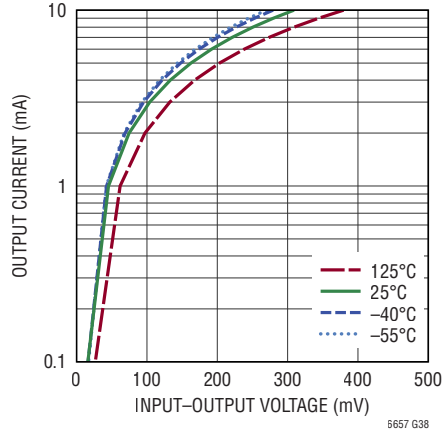

5V Minimum V_{IN} to V_{OUT} Differential (Sinking)

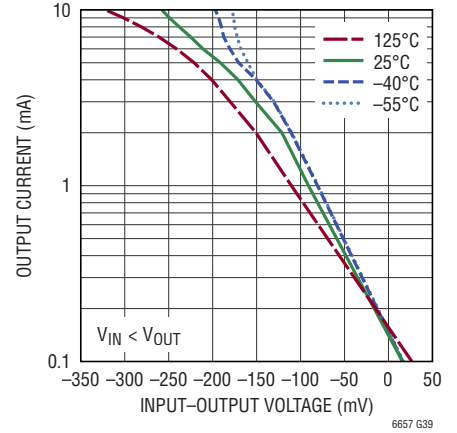

5V Output Impedance vs Frequency

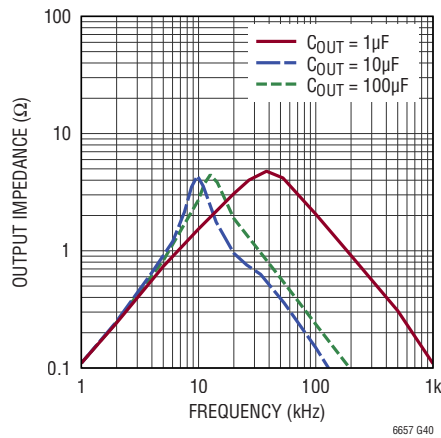

PIN FUNCTIONS

SHDN (Pin 3): Shutdown Input. This active low input disables the part to reduce supply current $< 2\mu\text{A}$. This pin must be driven externally and should be tied to V_{IN} if unused. It may be driven to logic high or to V_{IN} during normal operation.

V_{IN} (Pin 2): Input Voltage Supply. Bypass V_{IN} with a local $0.1\mu\text{F}$ ($1\mu\text{F}$ for 1.25V) or larger capacitor to GND.

GND (Pin 4): Device Ground. This pin must be connected to a noise-free ground plane. A star-ground with related circuits will give the best results. Be careful of trace impedance, as the GND pin carries supply return current.

V_{OUT} (Pin 6): Reference Output Voltage. This pin can source and sink current to a load. An output capacitor of $1\mu\text{F}$ ($2.7\mu\text{F}$ for 1.25V) or higher is required for stability.

DNC (Pins 1, 5, 7, 8): Internal Functions. Do Not Connect or electrically stress these pins. These pins must be left floating and leakage currents from these pins should be kept to a minimum. Allow additional routing clearance.

BLOCK DIAGRAM

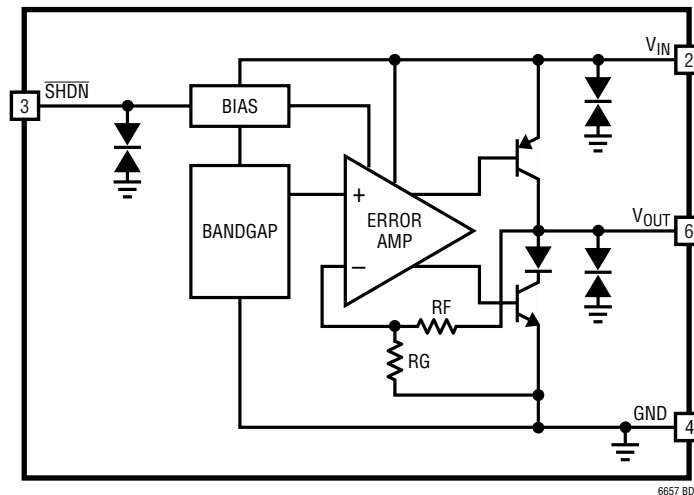

APPLICATIONS INFORMATION

Line and Load Regulation

The line regulation of the LT6657 is typically well below 1ppm/V. A 10V change in input voltage causes a typical output shift of only 2ppm. Load regulation is also less than 2 μ V/mA in an MS8 package. A 5mA change in load current shifts output voltage by only 10 μ V. These electrical effects are measured with low duty cycle pulses.

To realize such excellent load regulation the IR drops on the V_{OUT} and GND lines need to be minimized. One ounce copper foil printed circuit board has 0.5m Ω /square. Just 1m Ω of added trace resistance introduces an error of 1 μ V for each 1mA passing through it. This will add a 0.4ppm/mA to the load regulation with a 2.5V reference. These externally created errors have the same order of magnitude as the typical load regulation values for the LT6657. Minimizing wire resistance and using a separate ground return for the load will maintain excellent load regulation. When sourcing current, the ground connection pin can be used as kelvin sensing for improved output regulation.

Additional output changes due to die temperature change must be taken into account separately. These added effects may be estimated from:

$$\text{Line_Reg (in ppm)} = (I_{IN} + I_{OUT}) \cdot \theta_{JA} \cdot TC \cdot V_{IN}$$

$$\text{Load_Reg (in ppm)} = (V_{IN} - V_{OUT}) \cdot \theta_{JA} \cdot TC \cdot I_{OUT}$$

Where voltages are in V, currents are in mA, package thermal resistance θ_{JA} is in $^{\circ}\text{C}/\text{mW}$, and temperature coefficient, TC, is in ppm/ $^{\circ}\text{C}$. For example, with typical quiescent current $I_{IN} = 1.2\text{mA}$, $I_{OUT} = 1\text{mA}$, $V_{IN} - V_{OUT} = 1\text{V}$, the added line-regulation is typically 0.66ppm/V and added load-regulation is typically 0.3ppm/mA for a TC of 1ppm/ $^{\circ}\text{C}$ and MSOP-8 package with $\theta_{JA} = 0.3^{\circ}\text{C}/\text{mW}$ thermal resistance.

Bypass and Load Capacitors

The LT6657 voltage reference requires a 0.1 μ F (1 μ F for 1.25V) or larger input capacitor placed close to the part to improve power supply rejection. A long input wire with large series inductance can create ringing response to large load transients.

The output requires a capacitor of 1 μ F (2.7 μ F for 1.25V) or higher placed near the part. Frequency stability, turn-on

time and settling behavior are directly affected by the value and type of the output capacitor. Equivalent resistance in series with the output capacitor (ESR) introduces a zero in the output buffer transfer function and can cause instability. It is recommended to keep the ESR less than 0.5 Ω to maintain sufficient phase margin. Both capacitance and ESR are frequency dependent. At higher frequencies, capacitance drops and ESR increases. To ensure stability above 100kHz, the output capacitor must also have suitable characteristics above 100kHz. The following paragraphs describe capacitors with suitable performance.

For applications requiring a large output capacitor, a low ESR ceramic capacitor in parallel with a bulk tantalum capacitor provides an optimally damped response. For example, a 47 μ F tantalum capacitor with larger ESR in parallel with a 10 μ F ceramic capacitor with ESR smaller than 0.5 Ω improves transient response and increases phase margin.

Give extra consideration to the use of ceramic capacitors such as X7R types. These capacitors are small, come in appropriate values and are relatively stable over a wide temperature range. However, for low noise requirements, X7R capacitors may not be suitable as they may exhibit a piezoelectric effect. Mechanical vibrations cause a charge displacement in the ceramic dielectric and the resulting perturbations can appear as noise.

For very low noise applications, film capacitors should be considered for their lack of piezoelectric effects. Film capacitors such as polyester, polycarbonate and polypropylene have good temperature stability. Additional care must be taken as polypropylene have an upper limit of 85 $^{\circ}\text{C}$ to 105 $^{\circ}\text{C}$. Above these temperatures the working voltage often needs to be derated per manufacturer specifications. Another type of film capacitor is polyphenylene sulfide (PPS). These capacitors work over a wide temperature range, are stable and have large capacitance values beyond 1 μ F.

In voltage reference applications, film capacitor lifetime is affected by temperature and applied voltage. Capacitor lifetime is degraded by operating near or exceeding the rated voltage, at high temperature, with AC ripple or some combination of these. Most voltage reference applications present AC ripple only during transient events.

APPLICATIONS INFORMATION

Turn-On and Line Transient Response

The turn-on time is slew-limited and determined by the short-circuit current, the output capacitor, and the output voltage value as determined by the equation:

$$t_{ON} = V_{OUT} \cdot \frac{C_{OUT}}{I_{SC}}$$

For example, the LT6657-2.5V, with a 1μF output capacitor and a typical current limit of 15mA the turn-on time would be:

$$t_{ON} = 2.5V \cdot \frac{1\mu F}{15mA} = 167\mu s$$

The resulting turn-on time is shown in Figure 1.

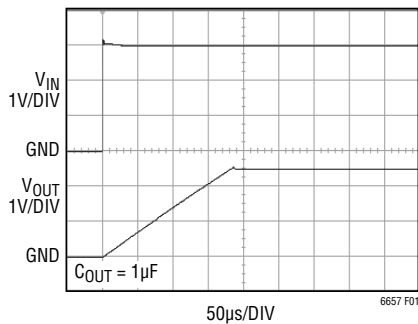

Figure 1. 2.5V Turn-On Characteristics

Line transient response with a 1μF output capacitor and no output current is shown in Figure 2. The peak voltage output response is less than 1mV.

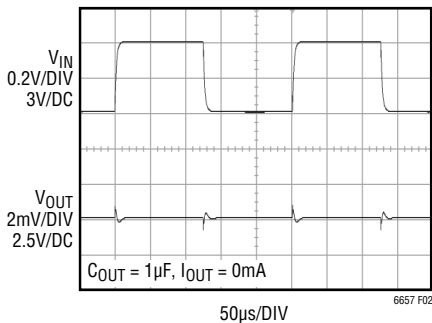

Figure 2. Line Transient Response with $V_{IN} = 0.4V_{p-p}$

Increasing the output load speeds up the response (Figure 3).

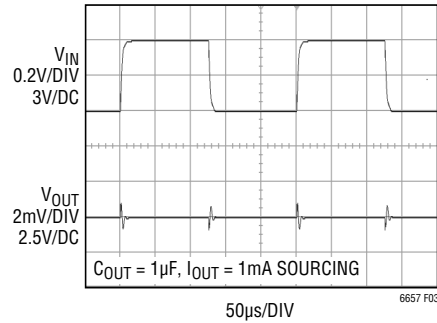

Figure 3. Line Transient Response with $V_{IN} = 0.4V_{p-p}$

A larger output capacitor lowers the amplitude response with a longer time response trade-off (Figure 4).

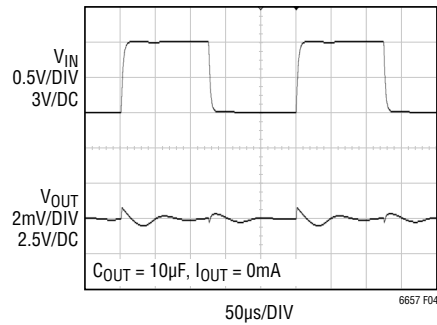

Figure 4. Line Transient Response with $V_{IN} = 1V_{p-p}$

Load Transient Response

The test circuit of Figure 5 is used to measure load transient response with various currents.

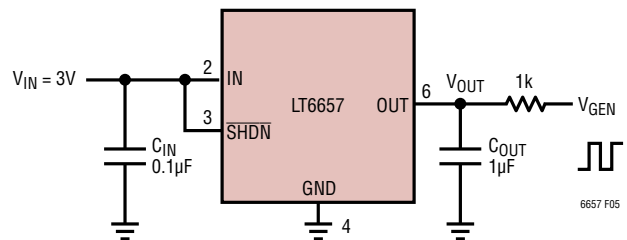

Figure 5. Transient Load Test Circuit

APPLICATIONS INFORMATION

Figure 6 and 7 shows the load transient response to a 5mA current step both sourcing and sinking.

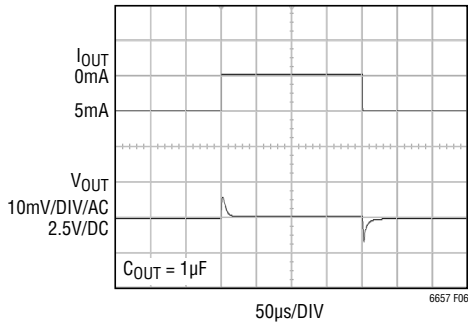

Figure 6. Output Response with a 5mA Load Step Sourcing

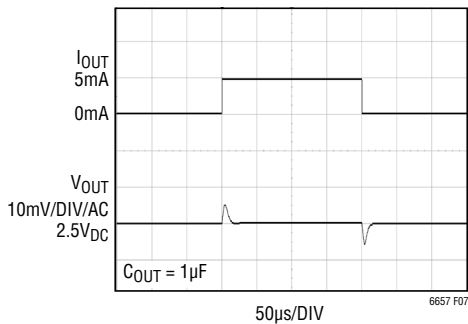

Figure 7. Output Response with a 5mA Load Step Sinking

Figure 8 and 9 shows the load transient response to a smaller 4mA to 5mA current step while sourcing and sinking.

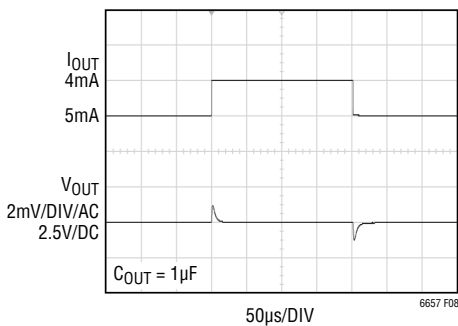

Figure 8. Output Response with a 4mA to 5mA Load Step Sourcing

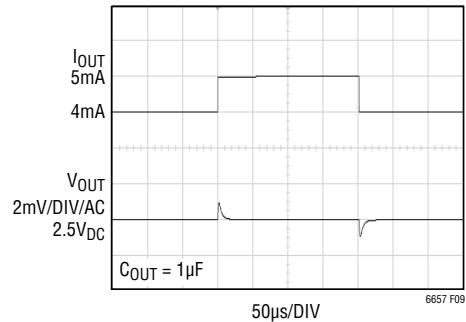

Figure 9. Output Response with a 4mA to 5mA Load Step Sinking

Figures 10 and 11 show the load transient response to an even smaller 0.5mA current step both sourcing and sinking.

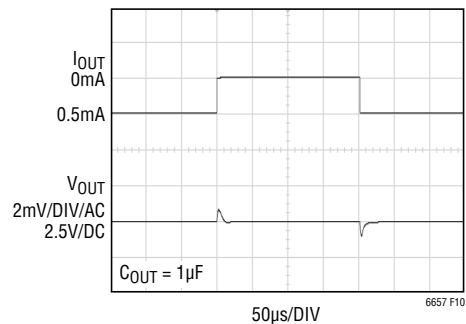

Figure 10. Output Response with a 0.5mA Load Step Sourcing

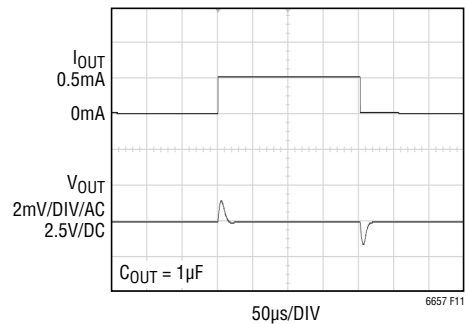

Figure 11. Output Response with a 0.5mA Load Step Sinking

APPLICATIONS INFORMATION

LT6657 Sinking Current Dropout Description

The LT6657 output stage can source and sink current of equal magnitude. When sourcing current it performs as a conventional low dropout regulating device. When sinking current, it can maintain a regulated output with an input voltage equal to, more positive than, or also slightly less than the output voltage. The specification for dropout voltage while sinking is expressed in negative voltage values for $V_{IN} - V_{OUT}$. A typical unit will maintain a regulated output voltage while sinking current with an input voltage 250mV (50mV guaranteed) below the output voltage (except LT6657-1.25). Lower input voltage will cause the output to drop out of regulation. This allows shunt reference applications where the output and input can be tied together and sink current from the output to ground.

Positive or Negative Shunt Mode Operation

In addition to the series mode operation, the LT6657 can be operated in shunt mode. In this mode the reference is wired as a two terminal circuit which can be used both as a positive or a negative voltage reference, as shown in Figures 12 and 13.

R_{SHUNT} is chosen using the following formula:

$$R_{SHUNT} = \frac{V_{DD} - V_{OUT}}{I_{SHUNT_MAX}}$$

where: $I_{SHUNT_MAX} = 2.5mA + I_{OUT_MAX}$

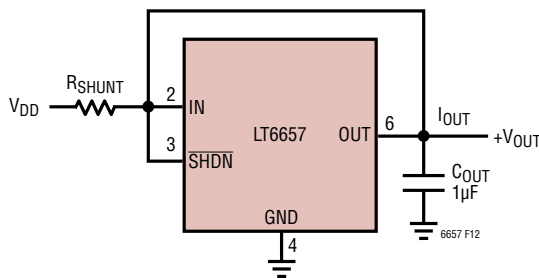

Figure 12. Positive Shunt Mode Operation

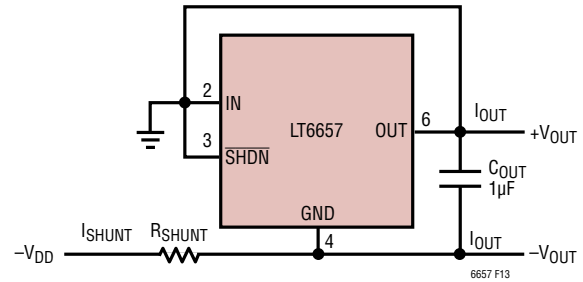

Figure 13. Negative Shunt Mode Operation

The I_{SHUNT} current has to be operated above 2.5mA to obtain the same performance as the series mode operation. In shunt mode operation I_{OUT_MAX} is less than or equal to 8.5mA. A C_{OUT} of 1µF or more is required on the output for stability. LT6657-1.25 functions in series mode only, and has the supply voltage as low as 1.5V (see Typical Applications).

Shutdown Mode

When the \overline{SHDN} pin is pulled below 0.8V with respect to ground, the LT6657 enters a low power state and turns the output off. Quiescent current is typically 2µA. If \overline{SHDN} is set less than 0.4V the quiescent current drops to 0.01µA typical. The \overline{SHDN} pin turn-on threshold is 1.26V and it has approximately 150mV hysteresis for the turn-off threshold. The turn-on logic high voltage is 1.6V (1.45V for LT6657-1.25). Drive the \overline{SHDN} with either logic or an open-collector/drain with a pull-up resistor. The resistor supplies the pull-up current to the open-collector/drain logic, normally several microamperes, plus the \overline{SHDN} pin current, typically less than 5µA at 6V. If unused, connect the \overline{SHDN} input pin to V_{IN} .

Power Dissipation

Power dissipation for LT6657 depends on V_{IN} , load current and the package type. The MSOP-8 package has a thermal resistance of $\theta_{JA} = 273^{\circ}C/W$.

Although the maximum junction temperature is 150°C, for best performance it is recommended to limit the change in junction temperature as much as possible. The plot in

APPLICATIONS INFORMATION

Figure 14 shows the maximum ambient temperature limits for different V_{IN} and load condition using a maximum junction temperature of 125°C in the MSOP-8 package. If the load current exceeds 10mA the parts could begin to current limit. In this case, the output voltage is no longer regulated and the part could dissipate much more power and operate hotter than the graph shows.

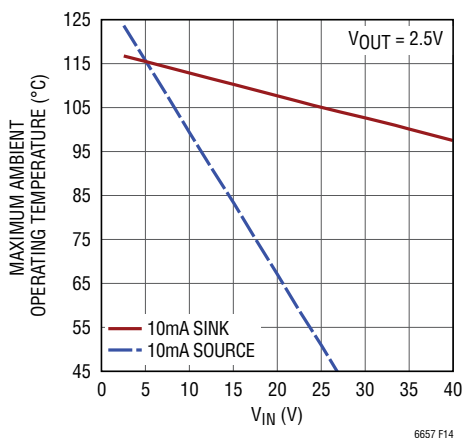

Figure 14. Maximum Ambient Operating Temperature

With a large input voltage and sourcing current, an internal thermal shutdown protection circuit limits the maximum power dissipation. When sinking current, there is no need for thermal shutdown protection because the power dissipation is much smaller and the sinking current limit will give some load protection.

Noise Performance and Specification

The LT6657 offers exceptional low noise for a bandgap reference; only 0.5ppm_{P-P} in the 0.1Hz to 10Hz bandwidth. As a result system noise performance may be dominated by system design and physical layout. Care is required to achieve the best possible noise performance. The use of dissimilar metals in component leads and PC board traces creates thermocouples. Variations in thermal resistance, caused by uneven air flow over the circuit board create differential lead temperature, thereby creating a thermoelectric voltage noise at the output of the reference. Minimizing the number of thermocouples, as well as limiting airflow, can substantially reduce these errors. Additional information can be found in Linear Technology Application Note 82.

Position the input and load capacitors close to the part. Although the LT6657 has 130dB DC PSRR, the power supply should be as stable as possible to guarantee optimal performance. A plot of the 0.1Hz to 10Hz low frequency noise is shown in the Typical Performance Characteristics section. Noise performance can be further improved by wiring several LT6657s in parallel as shown in the Typical Applications Section. With this technique the noise is reduced by \sqrt{N} , where N is the number of LT6657s used.

Noise in any frequency band is a random function based on physical properties such as thermal noise, shot noise, and flicker noise. The most precise way to specify a random error such as noise is in terms of its statistics, for example as an RMS value. This allows for relatively simple maximum error estimation, generally involving assumptions about noise bandwidth and crest factor. Unlike wideband noise, low frequency noise, typically specified in a 0.1Hz to 10Hz band, has traditionally been specified in terms of expected error, illustrated as peak-to-peak error. Low frequency noise is generally measured with an oscilloscope over a 10 second time frame. This is a pragmatic approach, given that it can be difficult to measure noise accurately at low frequencies, and that it can also be difficult to agree on the statistical characteristics of the noise, since flicker noise dominates the spectral density. While practical, a random sampling of 10 second intervals is an inadequate method for representation of low frequency noise, especially for systems where this noise is a dominant limit of system performance. Given the random nature of noise, the output voltage may be observed over many time intervals, each giving different results. Noise specifications that were determined using this method are prone to subjectivity, and will tend toward a mean statistical value, rather than the maximum noise that is likely to be produced by the device in question.

Because the majority of voltage reference data sheets express low frequency noise as a typical number, and as it tends to be illustrated with a repeatable plot near the mean of a distribution of peak-to-peak values, the LT6657 data sheet provides a similarly defined typical specification in order to allow a reasonable direct comparison against similar products. Data produced with this method generally

APPLICATIONS INFORMATION

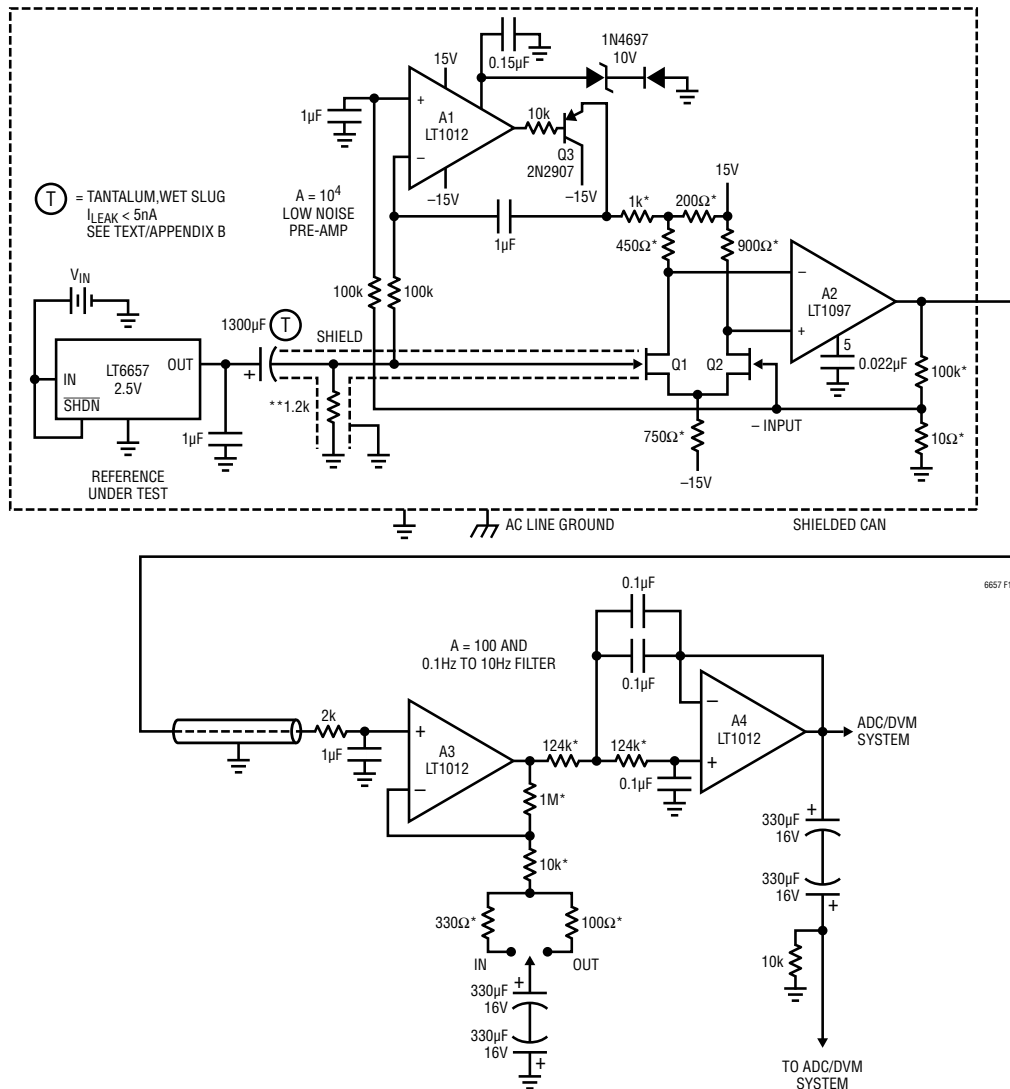

Figure 15. LT6657 Noise Test Circuitry (from AN124)

suggests that in a series of 10 second output voltage measurements, at least half the observations should have a peak-to-peak value that is below this number. For example, the LT6657-2.5 measures less than 0.5ppm_{P-P} in at least 50% of the 10 second observations.

As mentioned above, the statistical distribution of noise is such that if observed for long periods of time, the peak error in output voltage due to noise may be much larger than that observed in a smaller interval. The likely maximum error due to noise is often estimated using the RMS value, multiplied by an estimated crest factor, assumed to

be in the range of 6 to 8.4. This maximum possible value will only be observed if the output voltage is measured for very long periods of time. Therefore, in addition to the common method, a more thorough approach to measuring noise has been used for the LT6657 (described in detail in Linear Technology's AN124) that allows more information to be obtained from the result. In particular, this method characterizes the noise over a significantly greater length of time, resulting in a more complete description of low frequency noise. The reference noise is measured at the output of the circuit shown in Figure 15 with an ADC/DVM system. Peak-to-peak voltage is then calculated for 10

APPLICATIONS INFORMATION

second intervals over hundreds of intervals. The results are then summarized in terms of the fraction of measurement intervals for which observed noise is below a specified level. For example, the LT6657-2.5 measures less than 0.55ppm_{P-P} in 80% of the measurement intervals, and less than 0.59ppm_{P-P} in 95% of observation intervals. The preamplifier and filter are shown in Figure 15. This statistical variation in noise is illustrated in Figure 16.

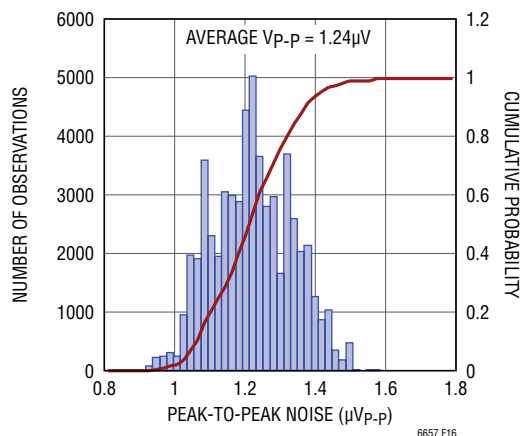

Figure 16. LT6657 Low Frequency Noise Histogram

This method of testing low frequency noise is more practical than common methods. The results yield a comprehensive statistical description, rather than a single observation. In addition, the direct measurement of output voltage over time gives an actual representation of peak noise, rather than an estimate based on statistical assumptions such as crest factor.

Hysteresis

Thermal hysteresis is a measure of change of output voltage as a result of temperature cycling. Figure 17 illustrates the typical hysteresis based on data taken from the LT6657-2.5. A proprietary design technique minimizes thermal hysteresis. The LT6657 is capable of dissipating relatively high power. For example, with a 40V input voltage and 5mA source load current applied to the LT6657-2.5, the power dissipation is $PD = 40V \cdot 1.4mA + 37.5V \cdot 5mA = 244mW$, which causes an increase in the die temperature of 73°C in MSOP-8 package. This could increase the junction temperature above 125°C and may cause the output to shift due to thermal hysteresis each time the device is powered up.

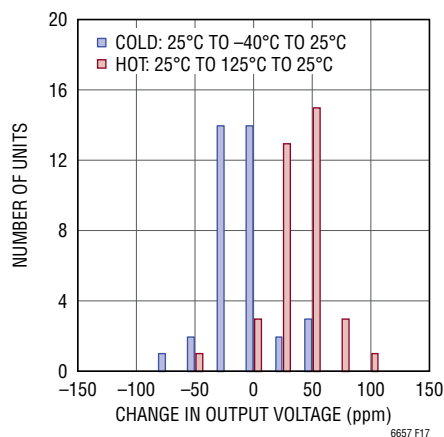

Figure 17. ΔV_{OUT} Due to Thermal Hysteresis

APPLICATIONS INFORMATION

Long-Term Drift

The LT6657 drift data was taken on parts that were soldered into PC boards similar to a real world application. The boards were then placed into a constant temperature oven with $T_A = 35^\circ\text{C}$, their outputs scanned regularly and measured with an 8.5 digit DVM. Typical long-term drift is illustrated in Figure 18a and 18b.

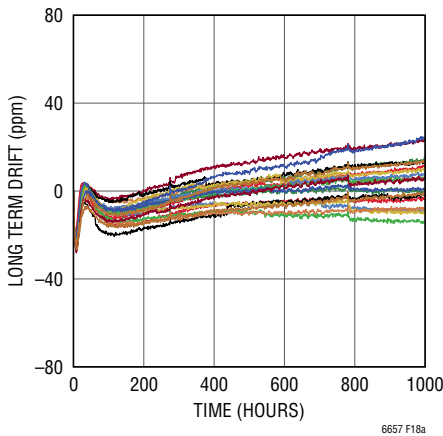

Figure 18a. Long-Term Drift

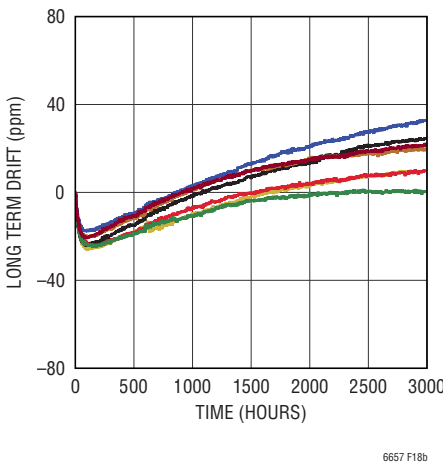

Figure 18b. Long-Term Drift Burn-In $150^\circ\text{C}/24\text{H}$

Figure 18.

PC Board Layout Stress

The LT6657 is a very stable reference over temperature with less than $1.5\text{ppm}/^\circ\text{C}$ error as shown in the Electrical Characteristics table. The mechanical stress caused by soldering parts to a printed circuit board may cause the output voltage to shift and the die temperature coefficient to change. The PC Board can affect all aspects of stability, including long term stability, thermal hysteresis and humidity stability. See Linear's AN82 for more detailed information.

IR Reflow Shift

The mechanical stress of soldering a part to a board can cause the output voltage to shift. Moreover, the heat of an IR reflow or convection soldering oven can also cause the output voltage to shift. The materials that make up a semiconductor device and its package have different rates of expansion and contraction. After a part undergoes the extreme heat of a lead-free IR reflow profile, like the one shown in Figure 19, the output voltage shifts. After the device expands, due to the heat, and then contracts, the stresses on the die move. This shift is similar to, but larger than thermal hysteresis.

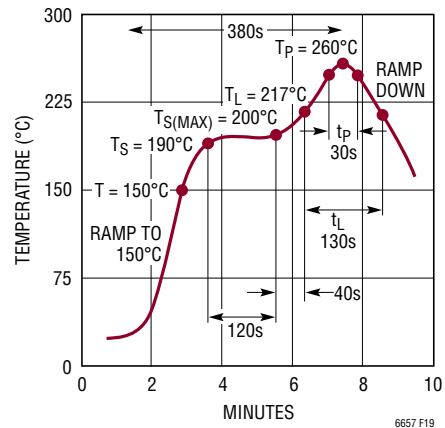

Figure 19. Lead-Free Reflow Profile

APPLICATIONS INFORMATION

Experimental results of IR reflow shift are shown in Figure 20. These results show only shift due to reflow and not mechanical stress.

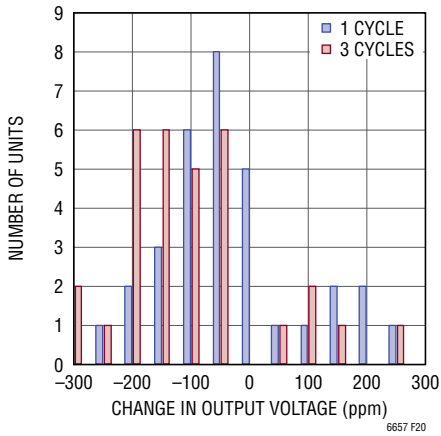
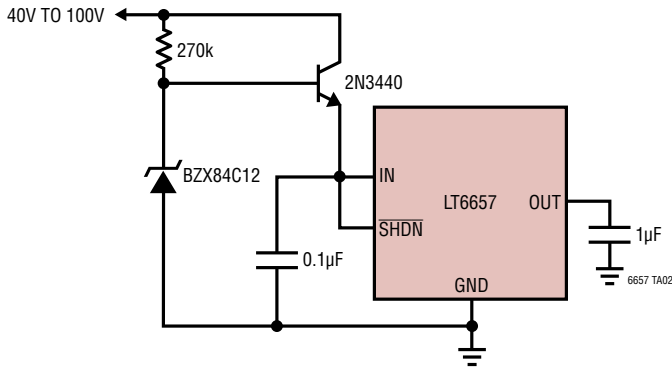

Figure 20. ΔV_{OUT} Due to IR Reflow, Peak Temperature = 260°C

TYPICAL APPLICATIONS

Extended Supply Range Reference



Boosted Output Current Reference

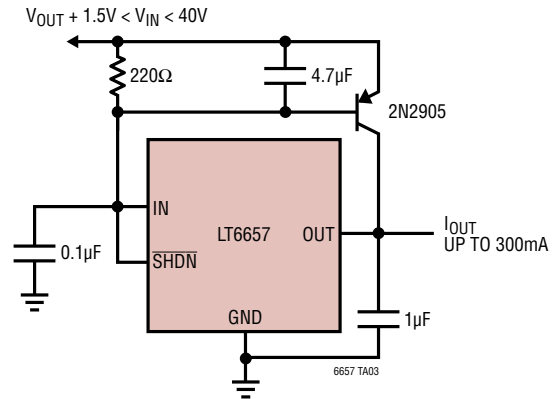

Boosted Output Current with Current Limit

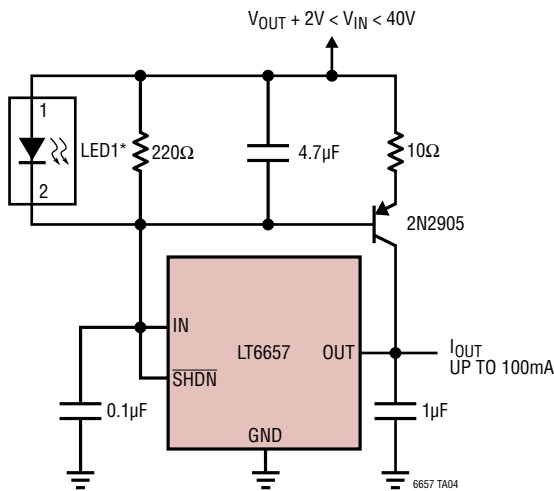

* LED CANNOT BE OMITTED
THE LED CLAMPS THE VOLTAGE
DROP ACROSS THE 220Ω AND
LIMITS OUTPUT CURRENT

Negative Shunt Mode Reference

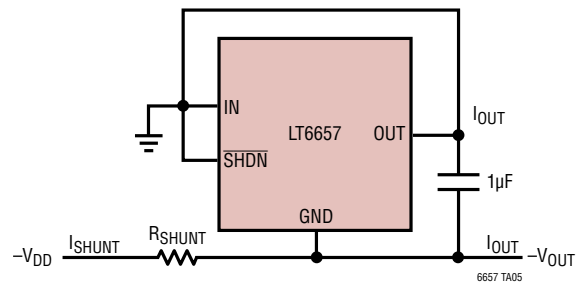

$$R_{SHUNT} = \frac{V_{DD} - V_{OUT}}{I_{SHUNT_MAX}}$$

$$I_{SHUNT_MAX} = 2.5mA + I_{OUT_MAX}$$

$$I_{OUT_MAX} < 8.5mA$$

(EXCLUDE 1.25V OPTION)

Sinking Current from External Circuitry

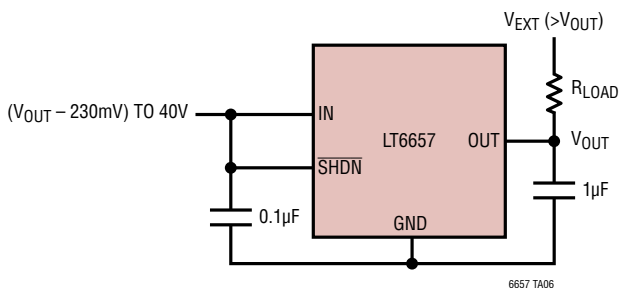

1.5V Minimum Supply Voltage

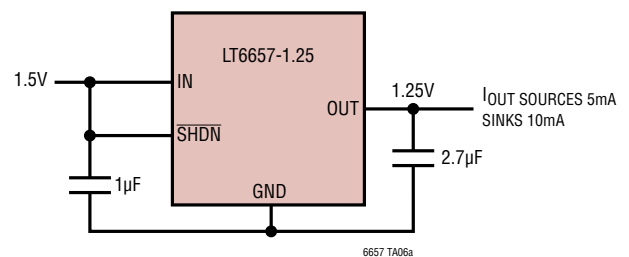

TYPICAL APPLICATIONS

Low Noise Statistical Averaging Reference
 $e_{NOUT} = e_N/\sqrt{N}$ Where N is the Number of LT6657s in Parallel

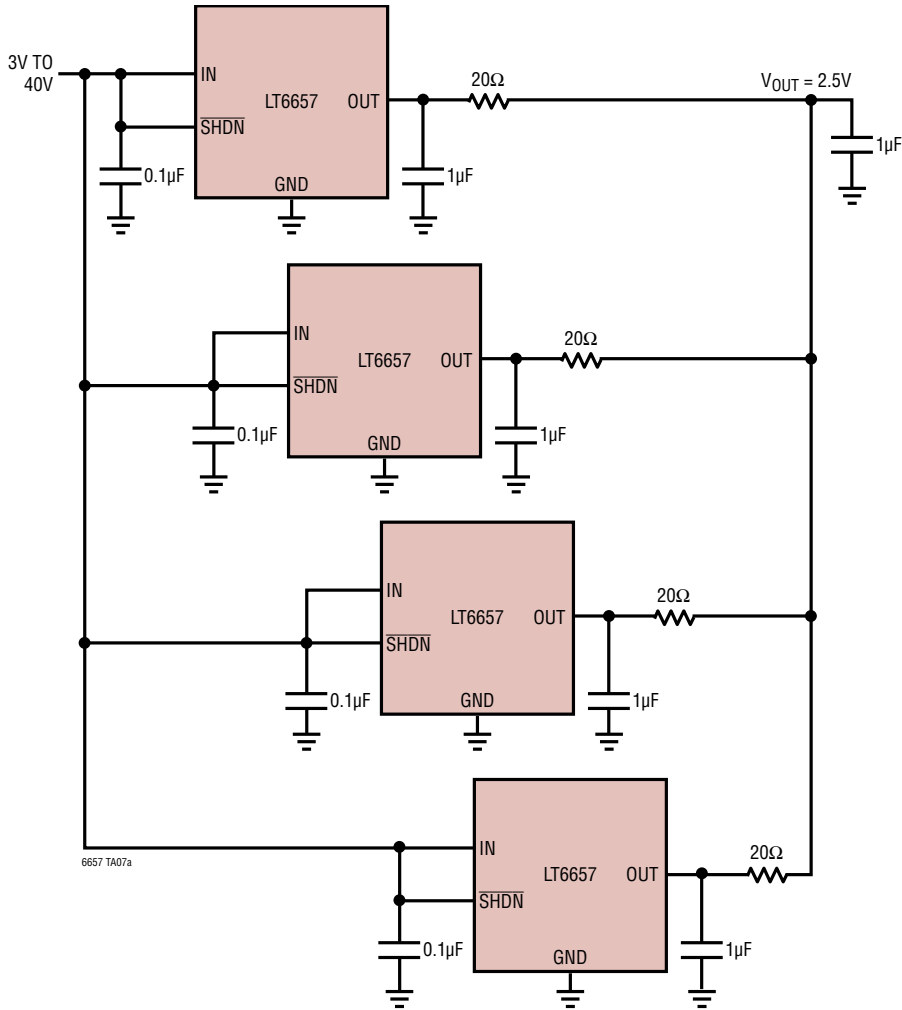

Low Frequency Noise (0.1Hz to 10Hz) with Four LT6657s in Parallel

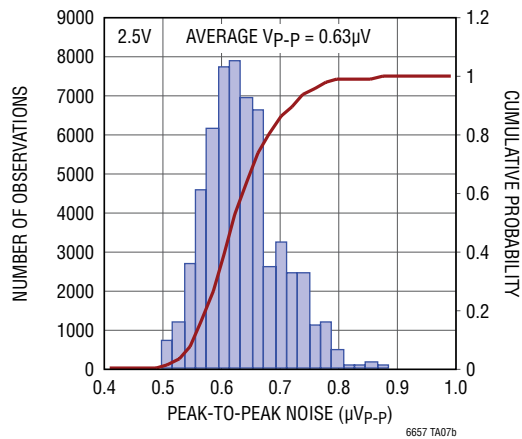

6657fd

PACKAGE DESCRIPTION

Please refer to <http://www.linear.com/product/LT6657#packaging> for the most recent package drawings.

MS8 Package 8-Lead Plastic MSOP

(Reference LTC DWG # 05-08-1660 Rev G)

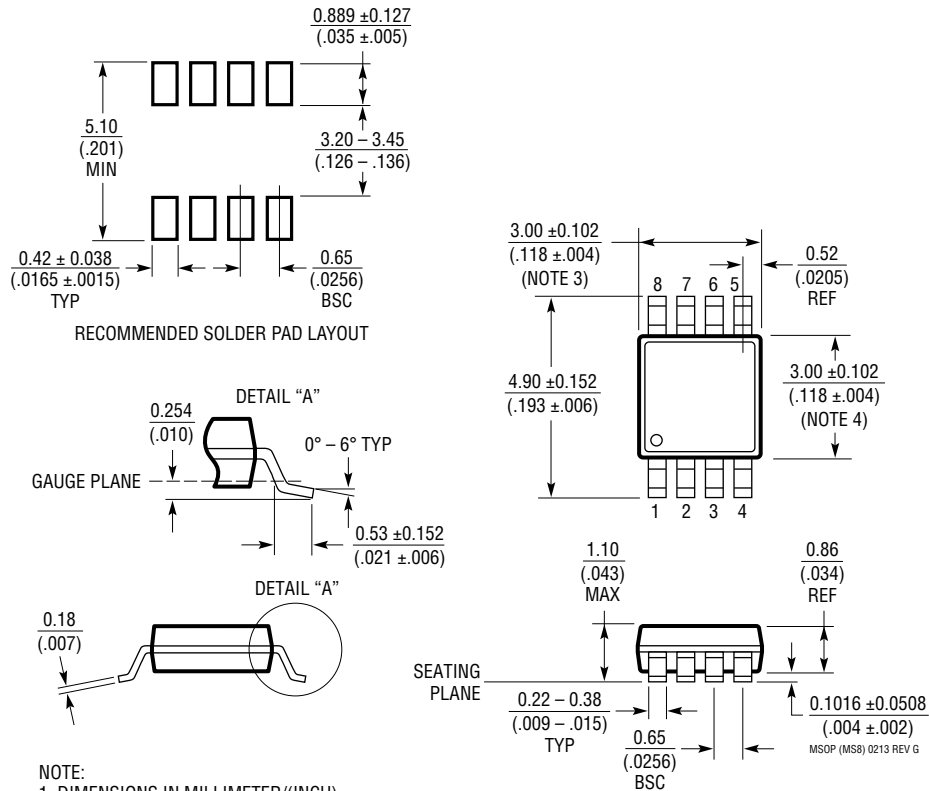

- NOTE:
1. DIMENSIONS IN MILLIMETER/(INCH)
 2. DRAWING NOT TO SCALE
 3. DIMENSION DOES NOT INCLUDE MOLD FLASH, PROTRUSIONS OR GATE BURRS. MOLD FLASH, PROTRUSIONS OR GATE BURRS SHALL NOT EXCEED 0.152mm (.006") PER SIDE
 4. DIMENSION DOES NOT INCLUDE INTERLEAD FLASH OR PROTRUSIONS. INTERLEAD FLASH OR PROTRUSIONS SHALL NOT EXCEED 0.152mm (.006") PER SIDE
 5. LEAD COPLANARITY (BOTTOM OF LEADS AFTER FORMING) SHALL BE 0.102mm (.004") MAX

REVISION HISTORY

REV	DATE	DESCRIPTION	PAGE NUMBER
A	03/16	Conditions Added for Electrical Characteristic, Minimum $V_{IN} - V_{OUT}$	3
B	06/16	Added 3V, 5V options Changed C_L , C_{LOAD} to C_{OUT} Corrected Graphs G03, G12	1, 2, 6, 7 9, 10, 11 5, 6
C	12/16	Added 1.25V option Changed Load Regulation from ppm/mA to $\mu V/mA$ Added $C_{IN} = 1\mu F$ and $C_{OUT} = 2.7\mu F$ for 1.25V option Excluded 1.25V option from Shunt Mode Operation	1, 2, 3, 4, 6, 7 1, 3, 11 3, 5-11 14
D	2/17	Added 4.096V option	1, 2, 3

TYPICAL APPLICATION

Low Noise Precision 20-Bit Analog-to-Digital Converter Application

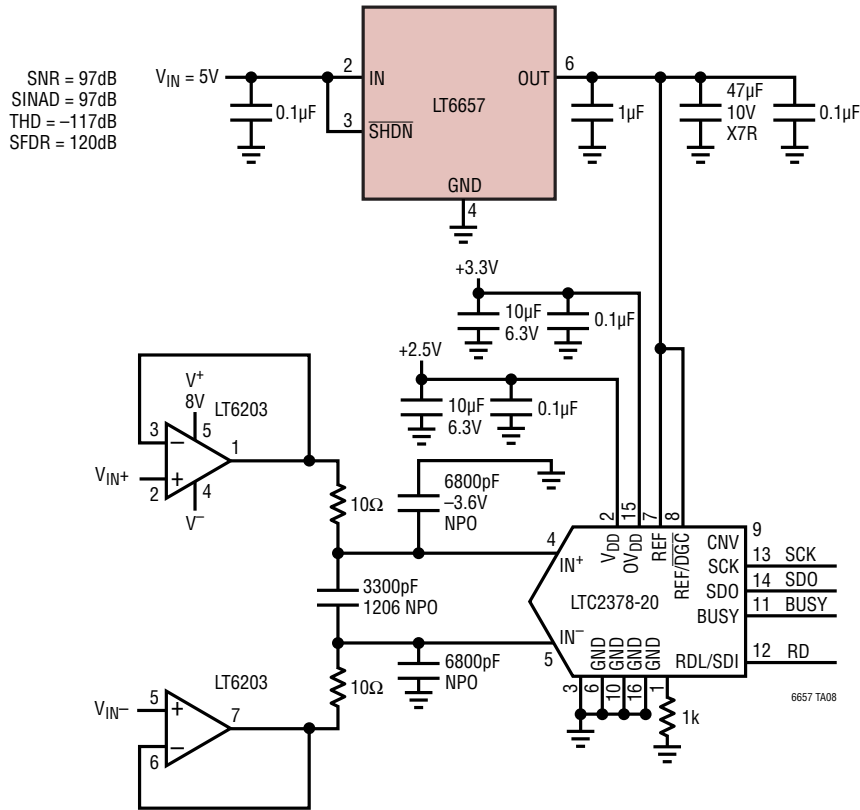

RELATED PARTS

PART NUMBER	DESCRIPTION	COMMENTS
LT1236	Precision Low Drift, Low Noise Reference	0.05% Max, 5ppm/°C Max, 1ppm (Peak-to-Peak) Noise
LT1460	Micropower Series References	0.075% Max, 10ppm/°C Max, 20mA Output Current
LT1461	Micropower Series Low Dropout	0.04% Max, 3ppm/°C Max, 50mA Output Current
LT1790	Micropower Precision Series References	0.05% Max, 10ppm/°C Max, 60µA Supply, SOT23 Package
LT6660	Tiny Micropower Series Reference	0.2% Max, 20ppm/°C Max, 20mA Output Current, 2mm x 2mm DFN
LT6650	Micropower Reference with Buffer Amplifier	0.5% Max, 5.6µA Supply, SOT23 Package
LTC6652	High Precision, Buffered Voltage Reference Family	0.05% Max Initial Error, 5ppm/°C Max Drift, Shutdown Current <2µA, -40°C to 125°C Operation
LT6654	Low Noise, High Voltage, High Output Drive Voltage Reference Family	1.6ppm Peak-to-Peak Noise (0.1Hz to 10Hz), Sink/Source ±10mA, 10ppm/°C Max Drift, -40°C to 125°C Operation
LTC6655	Precision, Very Low Noise and Temperature Drift, Voltage Reference Family	0.25ppm Peak-to-Peak Noise (0.1Hz to 10Hz), Sink/Source ±5mA, 0.025% Max, 2ppm/°C Max Drift, -40°C to 125°C Operation
LT6656	Ultra Low Current Series Voltage Reference Family	Supply Current < 1µA, 0.05% Max, 10ppm/°C, Sink/Source ±5mA

Looking for pricing, stock, or lifecycle information?

Click below to explore more details on WIN SOURCE:

- ⊖ [View LT6657BHMS8-4.096#PBF on WIN SOURCE](#)
- ⊖ [Analog Devices Inc. Information](#)

Optimize Your Supply Chain with WIN SOURCE Solutions

- ✓ Global Sourcing Solution
- ✓ Obsolete Management
- ✓ Cost Control Management
- ✓ Shortage Management
- ✓ Alternative Solution
- ✓ Excess Inventory Management