



**THE DATASHEET OF
BAS-M-R00005-EU-5.0**





ISA-WELD® // PRECISION RESISTORS



BAS // SIZE 8420 (METRIC)

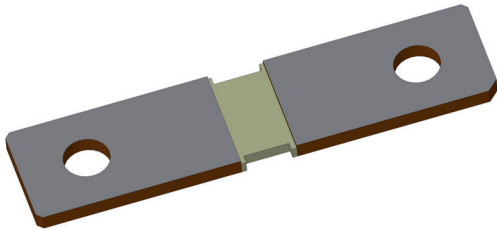

Features

- Up to 36 W permanent power
- Continuous current load up to 350 A (0.1 mOhm)
- High pulse power rating
- Max. fastening torque 10 Nm
- Shunt available with tinned or untinned terminals
- Further versions with various dimensions upon request
- AEC-Q200 qualified (automotive version "A")



Applications

- Current sensor for EBM (Electronic Battery Management) in motorcars, trucks, forklifts, hybrid and electric vehicles
- Current sensing in bus bars
- Current sensing in welding equipments

Technical data

Resistance values	mOhm	0.035 / 0.05 / 0.1 / 0.2 / 0.5
Tolerance	%	5
Temperature coefficient (20-60 °C)	ppm/K	50
Applicable temperature range	°C	-40 to +170
Power rating	W	up to 36*
Internal heat resistance (R _{thi})	K/W	see table on page 2
Thermal EMV (0-100 °C)	µV/K	0.6 (MANGANIN®) / 1 (ZERANIN®30)
Inductance	nH	<3
Stability (Nominal load) deviation after 2,000h		<0.5% (T _k = 110 °C)
T _k = Terminal temperature		<1.0% (T _k = 140 °C)

*see table on page 2

Packaging Information

140 pcs. per tube for automotive version „A“

100 pcs. sealed in plastic bags evacuated and refilled with dry nitrogen for non automotive version



Mechanical dimensions [mm] // Z-YJ-328a

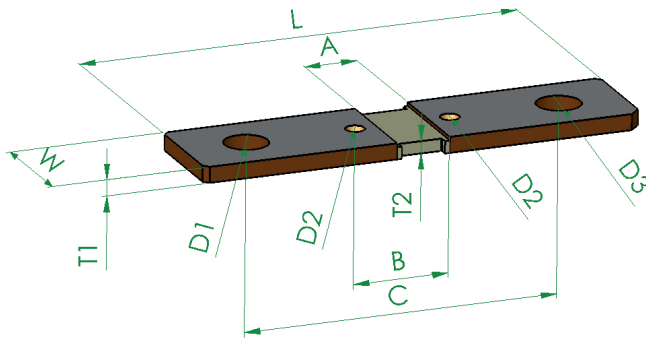

type	A	B	C	D1	D2	D3	L	T1	T2	W
BAS-M-R0001-E-5.0	10.1±0.5	-	60±0.2	∅8.3±0.1	-	∅8.3±0.1	84±0.2	3±0.15	2.3±0.2	20±0.1
BAS-M-R0001-AE-5.0	10.1±0.5	-	60±0.2	∅8.3±0.1	-	∅8.3±0.1	84±0.2	3±0.15	2.3±0.2	20±0.15
BAS-M-R0001-L-5.0	10.1±0.5	-	51±0.2	∅8.3±0.1	-	∅8.3±0.1	68±0.2	3±0.15	2.3±0.2	20±0.1
BAS-M-R0001-R-5.0	10.1±0.5	18.2±0.1	60±0.2	∅8.3±0.1	3.62±0.08	∅8.3±0.1	84±0.2	3±0.15	2.3±0.2	20±0.1
BAS-M-R0005-AE-5.0	5.2±0.3	-	60±0.2	∅8.3±0.1	-	∅8.3±0.1	84±0.2	3±0.15	2.3±0.2	20±0.15

Further versions available

Type	Value [mΩ]	R _{thi} [K/W]	TCR [ppm/K]	P _{70 °C}	P _{140 °C}
BAS-Z-R000035	0.035	1.0	100	36 W	30 W
BAS-M-R00005	0.05	1.5	100	36 W	20 W
BAS-M-R0001	0.1	2.0	50	36 W	15 W
BAS-M-R0002	0.2	3.0	50	24 W	10 W
BAS-M-R0005	0.5	7.0	50	10 W	4 W

Abbreviation type: M=MANGANIN®, Z=ZERANIN®30

Ordering code example

BAS - M - R0001 - A E - 5.0

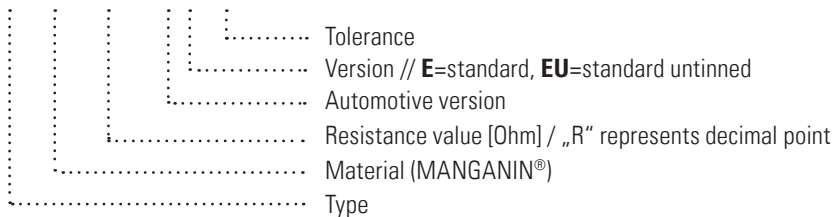

Connection diagram

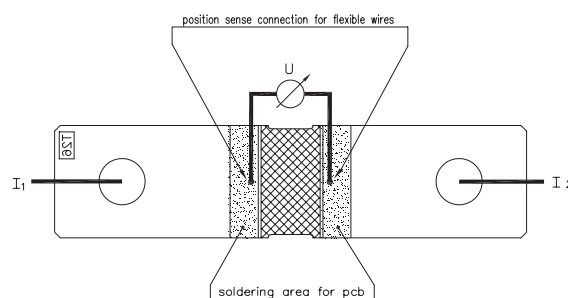

Z-DR-159a



Temperature dependence of the electrical resistance of MANGANIN® resistors

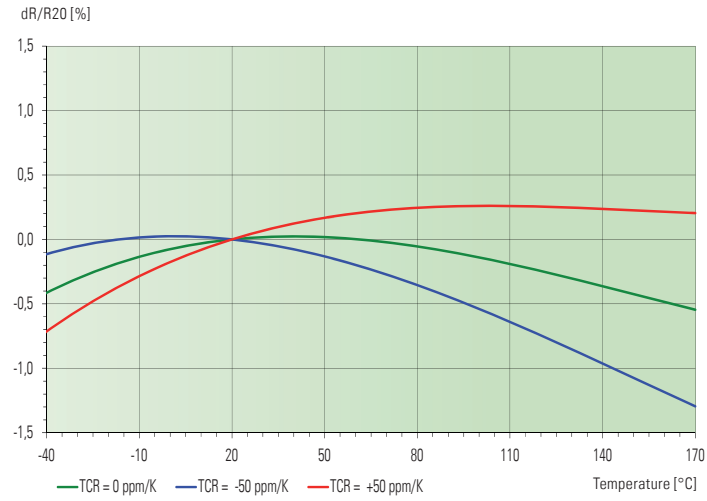

Temperature dependence of the electrical resistance of ZERANIN® resistors

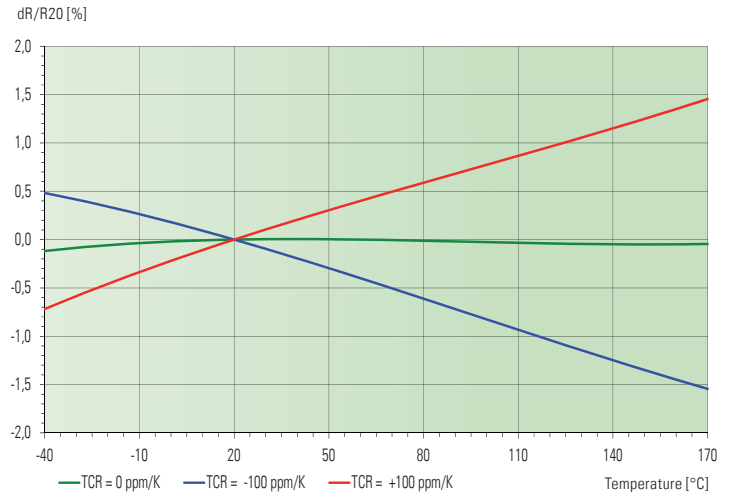

Power derating curve

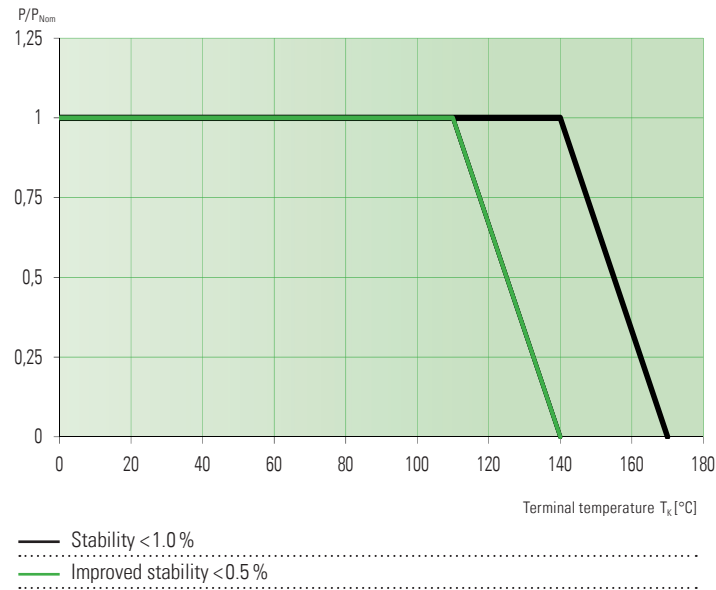



Maximum pulse energy respectively pulse power for permanent operation (TK=140°C)

BAS-Z-R00035, BAS-M-R00005, BAS-M-R0001, BAS-M-R0005

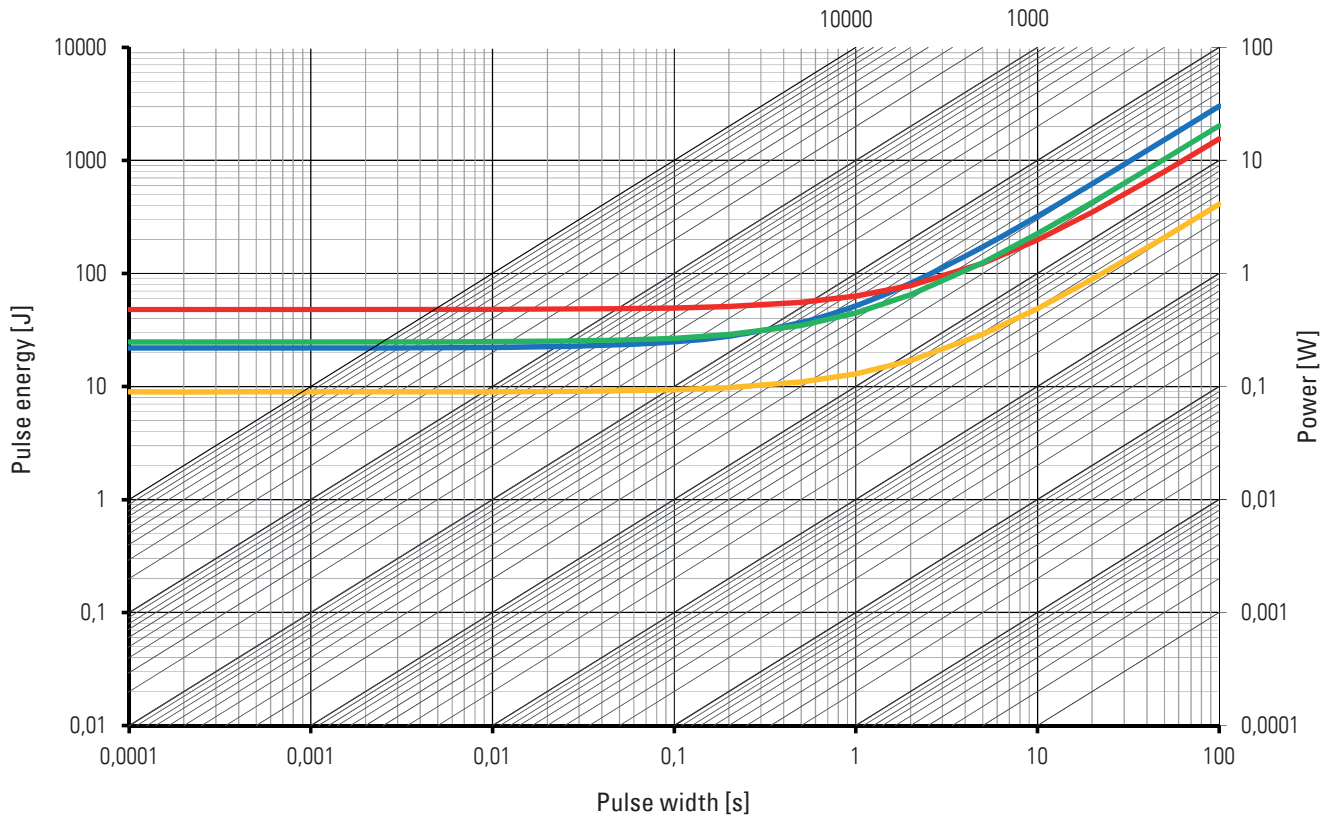

Disclaimer // All products, product specifications and data are subject to change without notice.

The product specifications do not expand or otherwise modify Isabellenhütte's terms and conditions of sale, including but not limited to, the warranty expressed therein. Isabellenhütte makes no warranty, representation or guarantee other than as set forth in its terms and conditions of sale. Information provided in datasheets and/or specifications may vary from actual results in different applications. Any statements made by Isabellenhütte regarding the suitability of products for certain types of applications are based on its knowledge of typical requirements that are often placed on its products. It is the customer's responsibility to validate that a particular product with the properties described in the product specification is suitable for use in the application intended.

No license, express or implied, or otherwise, to any intellectual property rights is granted by this document.

Any and all liability arising out of the application or use of any product shall be as set forth in Isabellenhütte's terms and conditions of sale.



Looking for pricing, stock, or lifecycle information?

Click below to explore more details on WIN SOURCE:

-  [View BAS-M-R00005-EU-5.0 on WIN SOURCE](#)
-  [Isabellen Information](#)

Optimize Your Supply Chain with WIN SOURCE Solutions

-  Global Sourcing Solution
-  Obsolete Management
-  Cost Control Management
-  Shortage Management
-  Alternative Solution
-  Excess Inventory Management