



**THE DATASHEET OF  
19K132-K00D3**



SMP

Adaptor  
SMP Jack – SMA Jack

**19K132-K00D3**

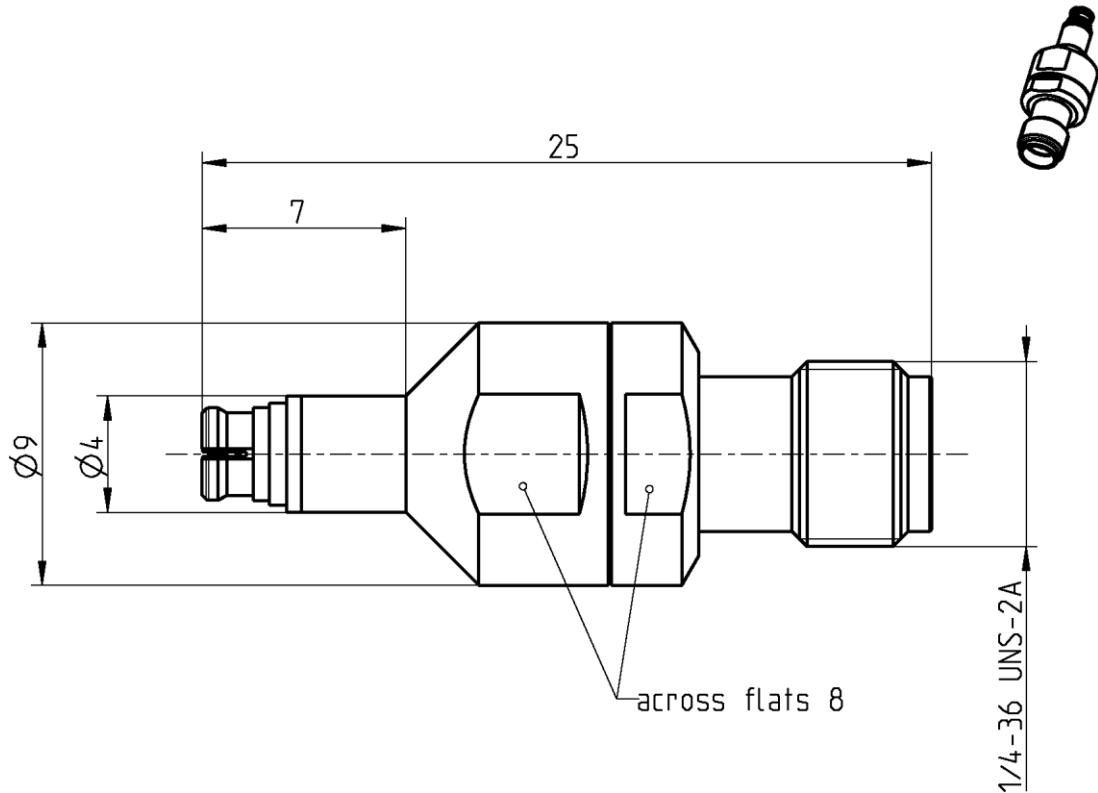

All dimensions are in mm; tolerances according to ISO 2768 m-H

**Interface**

According to	SMP side:	MIL-STD-348
	SMA side:	IEC 60169-15; EN 122110; MIL-STD-348

**Documents**

N/A

**Material and plating**

**Connector parts**

Center contact	<b>Material</b> CuBe	<b>Plating</b> Gold, min. 0.8 µm, over chemical nickel
Outer contact SMP side	CuBe	Gold, min. 1.27 µm, over chemical nickel
Outer contact SMA side	Stainless steel	Passivated
Dielectric	PTFE	

Dieses Dokument ist urheberrechtlich geschützt • This document is protected by copyright • Rosenberger Hochfrequenztechnik GmbH & Co. KG

RF\_35/09.14/6.2

SMP

Adaptor  
SMP Jack – SMA Jack

**19K132-K00D3**

**Electrical data**

Impedance	50 Ω	
Frequency	DC to 26.5 GHz	
Return loss	≥ 35 dB, DC to 4 GHz	
	≥ 26 dB, 4 to 10 GHz	
	≥ 18 dB, 10 to 18 GHz	
Insertion loss	≤ 0.05 x √f(GHz) dB	
Insulation resistance	≥ 5 GΩ	
Center contact resistance	≤ 6.0 mΩ, SMP side;	≤ 3 mΩ, SMA side
Outer contact resistance	≤ 2.0 mΩ, SMP side;	≤ 2 mΩ, SMA side
Test voltage	500 V rms	
Working voltage	335 V rms	
Contact Current	1.2A DC max.	

**Mechanical data**

	SMP side	SMA side
Mating cycles		min. 500
if mating part is smooth bore	≥ 1000	
if mating part is limited detent	≥ 500	
if mating part is full detent	≥ 100	
Center contact captivation: axial	≥ 27 N	≥ 27 N
Engagement force		N/A
- smooth bore	9 N max.	
- limited detent	45 N max.	
- full detent	68 N max.	
Disengagement force		N/A
- smooth bore	2.2 N min.	
- limited detent	9 N min.	
- full detent	22 N min.	
Coupling test torque	N/A	max. 1.7 Nm
Recommended torque	N/A	0.8 Nm to 1.1 Nm

**Environmental data**

Temperature range	-65°C to +155°C
Thermal shock	MIL-STD-202, Method 107, Condition B
Vibration	MIL-STD-202, Method 204, Condition B
Shock	MIL-STD-202, Method 213, Condition A
Moisture resistance	MIL-STD-202, Method 106
RoHS	compliant

**Tooling**

N/A

**Suitable cables**

N/A

**Weight**

Weight 4.6 g/pce

While the information has been carefully compiled to the best of our knowledge, nothing is intended as representation or warranty on our part and no statement herein shall be construed as recommendation to infringe existing patents. In the effort to improve our products, we reserve the right to make changes judged to be necessary.

For the installation of the electrotechnical equipment, particular electrotechnical expertise is required.



Dieses Dokument ist urheberrechtlich geschützt • This document is protected by copyright • Rosenberger Hochfrequenztechnik GmbH & Co. KG



RF\_35/09.14/6.2

Draft	Date	Approved	Date	Rev.	Engineering change number	Name	Date
Inge Mühlauer	17.08.04	Chr. Janßen	26.10.20	f00	20-1927	S. Huber-Siegl	26.10.20





Rosenberger Hochfrequenztechnik GmbH & Co. KG P.O.Box 1260 D-84526 Tittmoning Germany <a href="http://www.rosenberger.de">www.rosenberger.de</a>				Tel. : +49 8684 18-0 Email : <a href="mailto:info@rosenberger.de">info@rosenberger.de</a>		Page 2 / 2
--	--	--	--	--	--	---------------

## Looking for pricing, stock, or lifecycle information?

Click below to explore more details on WIN SOURCE:

-  [View 19K132-K00D3 on WIN SOURCE](#)
-  [Rosenberger Information](#)

## Optimize Your Supply Chain with WIN SOURCE Solutions

-  Global Sourcing Solution
-  Obsolete Management
-  Cost Control Management
-  Shortage Management
-  Alternative Solution
-  Excess Inventory Management