

DATA SHEET

THICK FILM WIDE TERMINAL CHIP RESISTORS AUTOMOTIVE GRADE

AC series

$\pm 5\%$, $\pm 1\%$, $\pm 0.5\%$

Sizes 0612/1020/1225

RoHS compliant & Halogen free



MARKING

AC0612 / AC1020 / AC1225

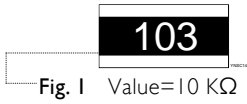

E-24 series: 3 digits, $\pm 5\%$
First two digits for significant figure and 3rd digit for number of zeros

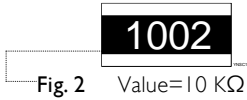

E-24/ E-96 series: 4 digits, $\pm 1\%$ & $\pm 0.5\%$
First three digits for significant figure and 4th digit for number of zeros

CONSTRUCTION

The resistors are constructed on top of a high-grade ceramic body. Internal metal electrodes are added at each end and connected by the resistive glaze. The resistive glaze is covered by a leadfree glass. The composition of the glaze is adjusted to give the approximate required resistance value and laser trimming of this resistive glaze achieves the value inside tolerance. The whole element is covered by a protective overcoat. Size 0508 and bigger is marked with the resistance value on top. Finally, the two external terminations (Ni / matte tin) are added. See fig.3.

OUTLINES

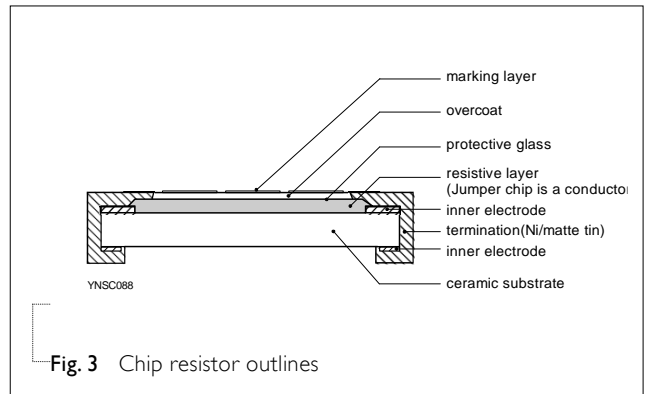

Fig. 3 Chip resistor outlines

DIMENSIONS

Table I For outlines, please refer to Fig. 4

TYPE	L (mm)	W (mm)	H (mm)	l ₁ (mm)	l ₂ (mm)
AC0612	1.60 \pm 0.20	3.20 \pm 0.20	0.55 \pm 0.10	0.18 \pm 0.15	0.40 \pm 0.15
AC1020	2.50 \pm 0.20	5.00 \pm 0.20	0.55 \pm 0.10	0.25 \pm 0.20	0.75 \pm 0.20
AC1225	3.20 \pm 0.20	6.40 \pm 0.20	0.55 \pm 0.10	0.45 \pm 0.20	0.75 \pm 0.20

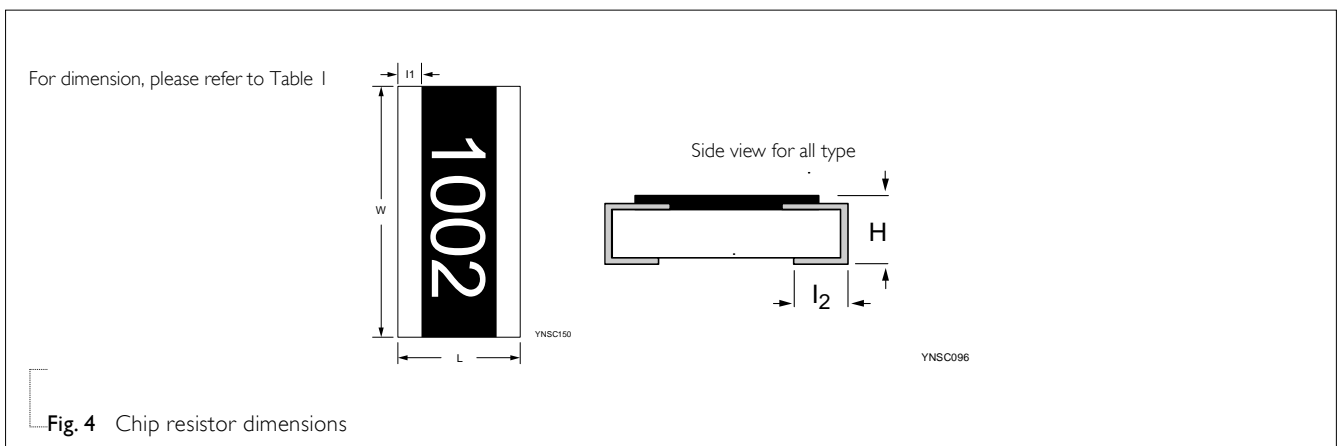

Fig. 4 Chip resistor dimensions

ELECTRICAL CHARACTERISTICS

Table 2

TYPE	RESISTANCE RANGE	CHARACTERISTICS					
		Operating Temperature Range	Max. Working Voltage	Max. Overload Voltage	Dielectric Withstanding Voltage	Temperature Coefficient of Resistance	Jumper Criteria
AC0612	5% (E24) 1Ω to 1MΩ		200V	400V	500V	0612: 1Ω ≤ R ≤ 10Ω, ±200ppm/ °C	Rated Current 2A
AC1020	0.5%, 1% (E24/E96) 1Ω to 1MΩ Jumper < 50mΩ	-55 °C to +155 °C	200V	400V	500V	1020~1225: 1Ω ≤ R < 10Ω, ±200ppm/ °C	
AC1225			200V	400V	500V	10Ω ≤ R ≤ 1MΩ, ±100ppm/ °C	Max. Current 10A

FOOTPRINT AND SOLDERING PROFILES

Recommended footprint and soldering profiles of AC-series is the same as RC-series. Please refer to data sheet “Chip resistors mounting”.

PACKING STYLE AND PACKAGING QUANTITY

Table 3 Packing style and packaging quantity

PACKING STYLE	REEL DIMENSION	AC0612	AC1020	AC1225
Paper taping reel (R)	7" (178 mm)	5,000	---	---
	13" (330 mm)	20,000	---	---
Embossed taping reel (K)	7" (178 mm)	---	4,000	4,000

NOTE

I. For paper/embossed tape and reel specifications/dimensions, please refer to data sheet “Chip resistors packing”.

FUNCTIONAL DESCRIPTION

OPERATING TEMPERATURE RANGE

Range: -55 °C to +155 °C

POWER RATING

Each type rated power at 70 °C:

AC0612 = 3/4W (0.75W)

AC1020 = 1W

AC1225 = 2W / 3W

RATED VOLTAGE

The DC or AC (rms) continuous working voltage corresponding to the rated power is determined by the following formula:

$$V = \sqrt{P \times R}$$

Or Maximum working voltage whichever is less

Where

V = Continuous rated DC or AC (rms) working voltage (V)

P = Rated power (W)

R = Resistance value (Ω)

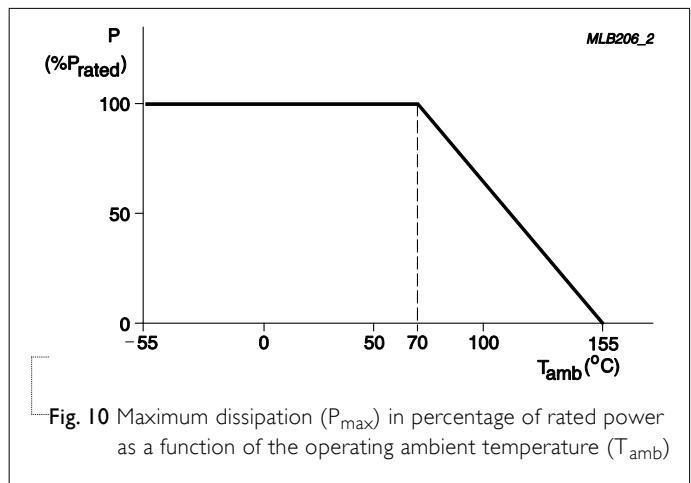

Fig. 10 Maximum dissipation (P_{max}) in percentage of rated power as a function of the operating ambient temperature (T_{amb})

TESTS AND REQUIREMENTS

Table 4 Test condition, procedure and requirements

TEST	TEST METHOD	PROCEDURE	REQUIREMENTS
High Temperature Exposure	AEC-Q200 Test 3 MIL-STD-202 Method 108	1,000 hours at $T_A = 155\text{ °C}$, unpowered	$\pm(1.0\%+0.05\Omega)$ for D/F tol $\pm(2.0\%+0.05\Omega)$ for J tol <50 m Ω for Jumper
Moisture Resistance	MIL-STD-202 Method 106	Each temperature / humidity cycle is defined at 8 hours, 3 cycles / 24 hours for 10d. with 25 °C / 65 °C 95% R.H, without steps 7a & 7b, unpowered Parts mounted on test-boards, without condensation on parts	$\pm(0.5\%+0.05\Omega)$ for D/F tol $\pm(2.0\%+0.05\Omega)$ for J tol <100 m Ω for Jumper
Biased Humidity	AEC-Q200 Test 7 MIL-STD-202 Method 103	1,000 hours; 85 °C / 85% RH 10% of operating power Measurement at 24 \pm 4 hours after test conclusion.	$\pm(1.0\%+0.05\Omega)$ for D/F tol $\pm(3.0\%+0.05\Omega)$ for J tol <100 m Ω for Jumper
Operational Life	AEC-Q200 Test 8 MIL-STD-202 Method 108	1,000 hours at 125 °C, derated voltage applied for 1.5 hours on, 0.5 hour off, still-air required	$\pm(1.0\%+0.05\Omega)$ for D/F tol $\pm(3.0\%+0.05\Omega)$ for J tol <100 m Ω for Jumper
Resistance to Soldering Heat	AEC-Q200 Test 15 MIL-STD-202 Method 210	Condition B, no pre-heat of samples Lead-free solder, 260 \pm 5 °C, 10 \pm 1 seconds immersion time Procedure 2 for SMD: devices fluxed and cleaned with isopropanol	$\pm(0.5\%+0.05\Omega)$ for D/F tol $\pm(1.0\%+0.05\Omega)$ for J tol <50 m Ω for Jumper No visible damage
Thermal Shock	MIL-STD-202 Method 107	-55/+125 °C Number of cycles is 300. Devices mounted Maximum transfer time is 20 seconds. Dwell time is 15 minutes. Air – Air	$\pm(0.5\%+0.05\Omega)$ for D/F tol $\pm(1.0\%+0.05\Omega)$ for J tol <50 m Ω for Jumper
ESD	AEC-Q200 Test 17 AEC-Q200-002	Human Body Model, 1 _{pos.} + 1 _{neg.} discharges 0612 and above: 2KV	$\pm(3.0\%+0.05\Omega)$ <50 m Ω for Jumper

TEST	TEST METHOD	PROCEDURE	REQUIREMENTS
Solderability - Wetting	AEC-Q200 Test 18 J-STD-002	Electrical Test not required Magnification 50X SMD conditions: (a) Method B, aging 4 hours at 155 °C dry heat, dipping at 235±3 °C for 5±0.5 seconds. (b) Method B, steam aging 8 hours, dipping at 215±3 °C for 5±0.5 seconds. (c) Method D, steam aging 8 hours, dipping at 260±3 °C for 30±0.5 seconds.	Well tinned (≥95% covered) No visible damage
Board Flex	AEC-Q200 Test 21 AEC-Q200-005	Chips mounted on a 100mm x 40mm glass epoxy resin PCB (FR4) Bending for 0612 and above: 2 mm Holding time: minimum 60 seconds	±(1.0%+0.05Ω) <50 mΩ for Jumper
Temperature Coefficient of Resistance (T.C.R.)	MIL-STD-202 Method 304	At +25/-55 °C and +25/+125 °C Formula: $T.C.R = \frac{R_2 - R_1}{R_1(t_2 - t_1)} \times 10^6 \text{ (ppm/°C)}$ Where t ₁ =+25 °C or specified room temperature t ₂ =-55 °C or +125 °C test temperature R ₁ =resistance at reference temperature in ohms R ₂ =resistance at test temperature in ohms	Refer to table 2
Short Time Overload	IEC60115-1 8.1	2.5 times of rated voltage or maximum overload voltage whichever is less for 1225 : 2s 0612/1020: 5s at room temperature	±(1.0%+0.05Ω) for D/F tol ±(2.0%+0.05Ω) for J tol <50 mΩ for Jumper
FOS	ASTM-B-809-95	Sulfur (saturated vapor) 500 hours, 60±2°C, unpowered	±(1.0%+0.05Ω)

REVISION HISTORY

REVISION	DATE	CHANGE NOTIFICATION	DESCRIPTION
Version 3	May 08, 2023	-	- Add power 3W for 1225
Version 2	Jan. 04, 2023	-	- 10ohm TCR upgrade to 100ppm, for 1020 and 1225.
Version 1	Dec. 11, 2022	-	- Tests and requirements update
Version 0	Aug. 21, 2015	-	- First issue of this specification

LEGAL DISCLAIMER

YAGEO, its distributors and agents (collectively, "YAGEO"), hereby disclaims any and all liabilities for any errors, inaccuracies or incompleteness contained in any product related information, including but not limited to product specifications, datasheets, pictures and/or graphics. YAGEO may make changes, modifications and/or improvements to product related information at any time and without notice.



YAGEO makes no representation, warranty, and/or guarantee about the fitness of its products for any particular purpose or the continuing production of any of its products. To the maximum extent permitted by law, YAGEO disclaims (i) any and all liability arising out of the application or use of any YAGEO product, (ii) any and all liability, including without limitation special, consequential or incidental damages, and (iii) any and all implied warranties, including warranties of fitness for a particular purpose, non-infringement and merchantability.

YAGEO products are designed for general purpose applications under normal operation and usage conditions. Please contact YAGEO for the applications listed below which require especially high reliability for the prevention of defects which might directly cause damage to the third party's life, body or property: Aerospace equipment (artificial satellite, rocket, etc.), Atomic energy-related equipment, Aviation equipment, Disaster prevention equipment, crime prevention equipment, Electric heating apparatus, burning equipment, Highly public information network equipment, data-processing equipment, Medical devices, Military equipment, Power generation control equipment, Safety equipment, Traffic signal equipment, Transportation equipment and Undersea equipment, or for any other application or use in which the failure of YAGEO products could result in personal injury or death, or serious property damage. Particularly **YAGEO Corporation and its affiliates do not recommend the use of commercial or automotive grade products for high reliability applications or manned space flight.**

Information provided here is intended to indicate product specifications only. YAGEO reserves all the rights for revising this content without further notification, as long as products are unchanged. Any product change will be announced by PCN.

Looking for pricing, stock, or lifecycle information?

Click below to explore more details on WIN SOURCE:

-  [View AC0612FR-071R2L on WIN SOURCE](#)
-  [Yageo Information](#)

Optimize Your Supply Chain with WIN SOURCE Solutions

-  Global Sourcing Solution
-  Obsolete Management
-  Cost Control Management
-  Shortage Management
-  Alternative Solution
-  Excess Inventory Management