



THE DATASHEET OF
AP7375-50W5-7



Description

The AP7375 series is a wide input voltage range (45V), low quiescent current (2.1µA), low-dropout linear regulator (LDO) able to provide 300mA load current. The AP7375 family of LDOs offers an EN pin that takes an input voltage of 45V to enable and disable the LDO output.

The device features very fast response times against line voltage transient and load current transient, and ensures no overshoot voltage during start-up and short-circuit recovery. It also features integrated short-circuit and thermal shutdown protection.

The AP7375 has 1.8V, 3.0V, 3.3V, 3.6V, and 5.0V fixed output voltage versions, and is available in the SOT23, SOT25, SOT89, and U-DFN2020-6 (SWP) (Type UXC) packages.

Features

- Wide Input Voltage Range: 3V to 45V
- Maximum Output Current: 300mA
- Low Dropout Voltage:
 $V_{DROP} = 35mV @ I_{OUT} = 10mA$ (typ.)
 $V_{DROP} = 350mV @ I_{OUT} = 100mA$ (typ.)
- Low Quiescent Current: 2.1µA (typ.)
- Fixed Output Voltages: 1.8V, 3.0V, 3.3V, 3.6V and 5.0V
- High Output Voltage Accuracy: $\pm 2\%$
- High PSRR: 85dB @ 1kHz
- Excellent Line/Load Regulation
- Thermal Shutdown Function
- **Totally Lead-Free & Fully RoHS Compliant (Notes 1 & 2)**
- **Halogen and Antimony Free. "Green" Device (Note 3)**
- **An automotive-compliant part is available under separate datasheet ([AP7375Q](#)).**

Applications

- Battery-powered equipment
- Smoke detectors and sensors
- Microcontroller applications
- Home appliances

Pin Assignments

(Top View)

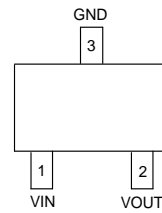

SOT23

(Package Code: SA)

(Top View)

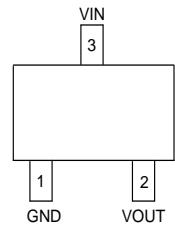

SOT23

(Package Code: SR)
(Future Product)

(Top View)

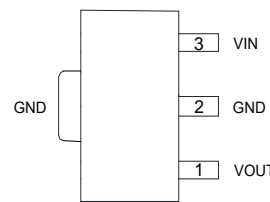

SOT89

(Package Code: Y)

(Top View)

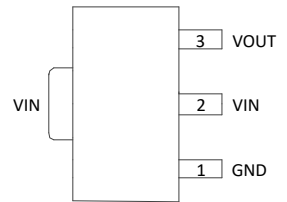

SOT89

(Package Code: YR)
(Future Product)

(Top View)

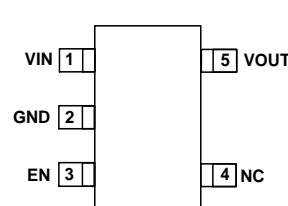

SOT25

(Package Code: W5)

(Top View)

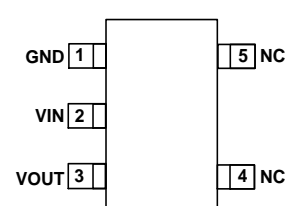

SOT25

(Package Code: WR)
(Future Product)

(Top View)

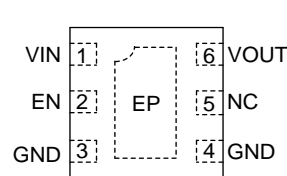

U-DFN2020-6 (SWP) (Type UXC)

(Package Code: FDCW)

(Top View)

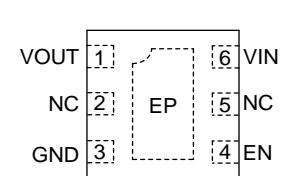

U-DFN2020-6 (SWP) (Type UXC)

(Package Code: FDCWR)

Notes: 1. No purposely added lead. Fully EU Directive 2002/95/EC (RoHS), 2011/65/EU (RoHS 2) & 2015/863/EU (RoHS 3) compliant.
 2. See <https://www.diodes.com/quality/lead-free/> for more information about Diodes Incorporated's definitions of Halogen- and Antimony-free, "Green" and Lead-free.
 3. Halogen- and Antimony-free "Green" products are defined as those which contain <900ppm bromine, <900ppm chlorine (<1500ppm total Br + Cl) and <1000ppm antimony compounds.

Typical Applications Circuit

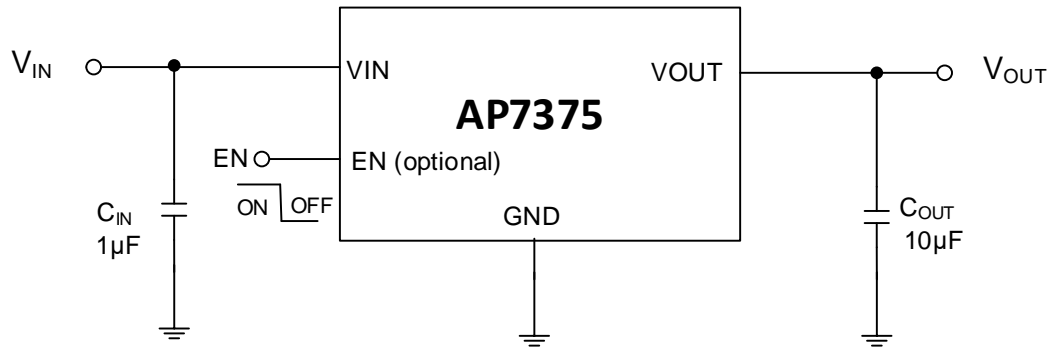

Pin Descriptions

Pin Number						Pin Name	Function
SOT25 (W)	SOT25 (WR)	SOT23 (SA)	SOT23 (SR)	SOT89 (Y)	SOT89 (YR)		
1	2	1	3	3	2	VIN	Input voltage
2	1	3	1	2	1	GND	Ground
3	—	—	—	—	—	EN	Enable
5	3	2	2	1	3	VOUT	Regulated output voltage
4	4, 5	—	—	—	—	NC	Not Connected internally, recommend connect to GND to maximize PCB copper for thermal dissipation.
—	—	—	—	—	—	Expose Pad	In PCB layout, it is preferred to use a large copper area to cover this pad for better thermal dissipation, then connect this area to GND or leave it open. However, do not use solely for GND electrode functionality.

Pin Number		Pin Name	Function
U-DFN2020-6 (SWP) (Type UXC) (FDCW)	U-DFN2020-6 (SWP) (Type UXC) (FDCWR)		
1	6	VIN	Input voltage
3, 4	3, EP	GND	Ground
2	4	EN	Enable
6	1	VOUT	Regulated output voltage
5	2, 5	NC	Not Connected internally, recommended to connect to GND to maximize PCB copper for thermal dissipation.
EP	—	Expose Pad	In PCB layout, it is preferred to use a large copper area to cover this pad for better thermal dissipation, then connect this area to GND or leave it open. However, do not use solely for GND electrode functionality.

Functional Block Diagram

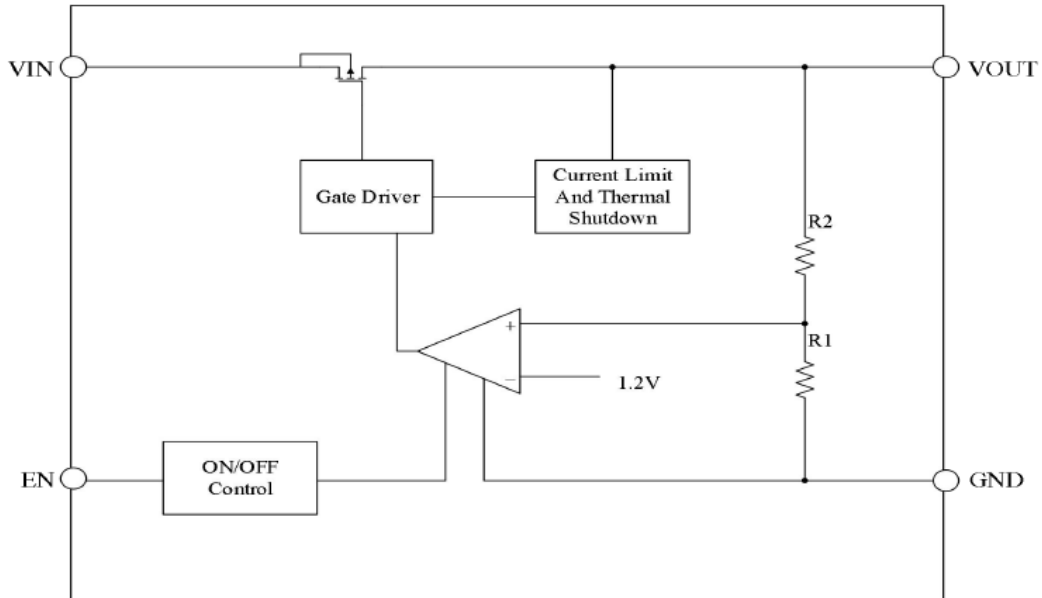

Absolute Maximum Ratings (Note 4) (@ $T_A = +25^\circ\text{C}$, unless otherwise specified.)

Symbol	Parameter	Rating	Unit	
V_{IN}	Supply Input Voltage	-0.3 to 55	V	
V_{OUT}	Regulated Output Voltage	-0.3 to 6	V	
—	V_{OUT} to V_{IN}	-55 to 0.3	V	
V_{EN}	EN to GND	-0.3 to 55	V	
I_{OUT}	Output Current	Internally limited	mA	
T_{LEAD}	Lead Temperature (Soldering, 10sec)	+260	$^\circ\text{C}$	
T_J	Operating Junction Temperature	+150	$^\circ\text{C}$	
T_A	Operating Ambient Temperature	-40 to +85	$^\circ\text{C}$	
θ_{JA}	Thermal Resistance (Junction to Ambient)	SOT25	153	$^\circ\text{C}/\text{W}$
		SOT23	164	
		SOT89	95	
		U-DFN2020-6 (SWP) (Type UXC)	99.5	
T_{STG}	Storage Temperature Range	-40 to +150	$^\circ\text{C}$	
CDM	ESD (Charge Device Model)	1.5V	kV	
HBM	ESD (Human Body Model)	4V	kV	

Note: 4. a). Stresses greater than those listed under "Absolute Maximum Ratings" can cause permanent damage to the device. These are stress ratings only, and functional operation of the device at these or any other conditions beyond those indicated under "Recommended Operating Conditions" is not implied. Exposure to "Absolute Maximum Ratings" for extended periods can affect device reliability.
 b). Ratings apply to ambient temperature at +25°C. The JEDEC STD.51 High-K board design used to derive this data was a 3 inch x 3 inch multilayer board with 1oz. internal power and ground planes and 2oz. copper traces on the top and bottom of the board.

Recommended Operating Conditions

Symbol	Parameter	Min	Typ	Max	Unit
V _{IN}	Supply Input Voltage	3.0	—	45	V
V _{OUT}	Output Voltage	—	—	5	V
T _J	Operating Junction Temperature	-40	—	+125	°C
C _{IN}	Input Capacitor	—	1	—	μF
C _{OUT}	Output Capacitor	1	10	—	μF

Electrical Characteristics (T_A = +25°C, I_{OUT} = 1mA, C_{IN} = 1μF, C_{OUT} = 10μF ceramic capacitor, V_{IN} = V_{OUTNOM} + 2.0V.)

Symbol	Parameter	Test Conditions	Min	Typ	Max	Unit
V _{IN}	Input Voltage	—	3	—	45	V
I _{GND}	Quiescent Current	V _{IN} = 12V, No Load	—	2.1	5	μA
V _{OUT}	Output Voltage	V _{IN} = 12V, I _{OUT} = 10mA	V _{OUT} x98%	—	V _{OUT} x102%	V
I _{OUT_MAX}	Output Current	—	300	350	—	mA
V _{DROP}	Dropout Voltage	I _{OUT} = 10mA, V _{IN} = V _{OUTNOM} - 0.1V	—	35	50	mV
		I _{OUT} = 100mA, V _{IN} = V _{OUTNOM} - 0.1V	—	350	360	mV
ΔV _{OUT} (ΔI _{OUT})	Load Regulation (Note 5)	V _{IN} = 12V, 1mA ≤ I _{OUT} ≤ 100mA	—	0.02	0.025	%/mA
ΔV _{OUT} (ΔV _{IN})	Line Regulation	V _{OUTNOM} + 0.5 V ≤ V _{IN} ≤ 45V, I _{OUT} = 1mA	—	0.01	0.02	%/V
I _{LIMIT}	Current Limit	—	—	500	—	mA
T _{OTSD}	Thermal Shutdown Temperature (Note 6)	—	—	+150	—	°C
T _{HYOTSD}	Thermal Shutdown Hysteresis (Note 6)	—	—	+20	—	°C
PSRR	Power Supply Rejection Ratio (Note 6)	V _{IN} = 12V, I _{OUT} = 10mA, V _{OUT} = 3.3V @ 1kHz	—	85	—	dB
VENH	EN High Level	Enabled	1	—	—	V
VENL	EN Low Level	Disabled	—	—	0.4	V
θ _{JC}	Thermal Resistance Junction to Case (Note 4)	SOT25	—	54	—	°C/W
		SOT23	—	85	—	
		SOT89	—	44	—	
		U-DFN2020-6 (SWP) (Type UXC)	—	15.8	—	

- Note:
4. a). Stresses greater than those listed under “Absolute Maximum Ratings” can cause permanent damage to the device. These are stress ratings only, and functional operation of the device at these or any other conditions beyond those indicated under “Recommended Operating Conditions” is not implied. Exposure to “Absolute Maximum Ratings” for extended periods can affect device reliability.
 - b). Ratings apply to ambient temperature at +25°C. The JEDEC STD.51 High-K board design used to derive this data was a 3 inch x 3 inch multilayer board with 1oz. internal power and ground planes and 2oz. copper traces on the top and bottom of the board.
 5. The AP7375 internal circuitry is not fully operation until V_{IN} is at least the greater of 3V or (V_{OUT} + V_{DROPOUT(MAX)}).
 6. This SPEC is guaranteed by design. All items other than those are tested.

Performance Characteristics

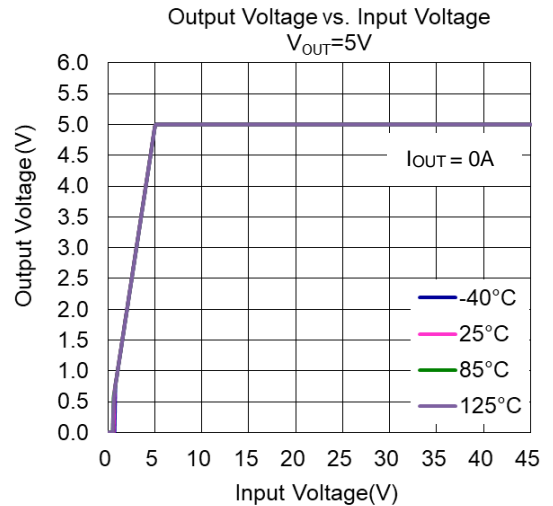
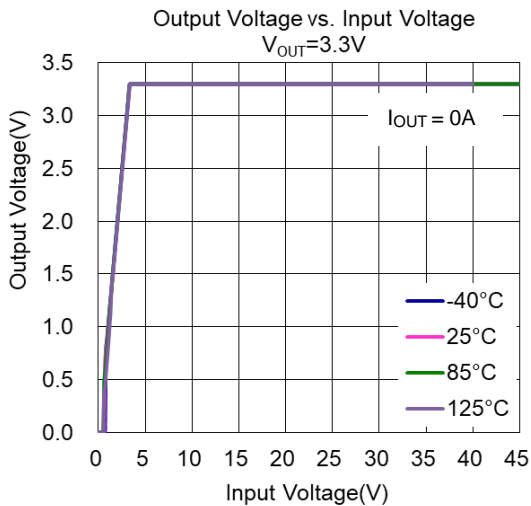
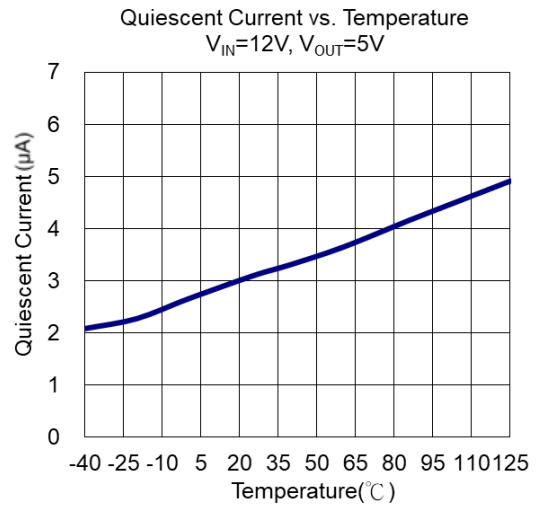
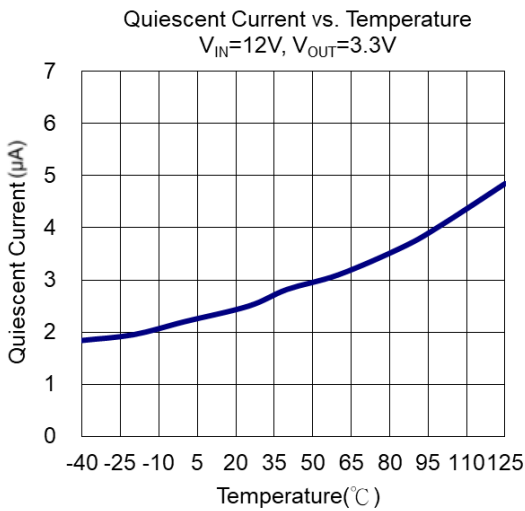
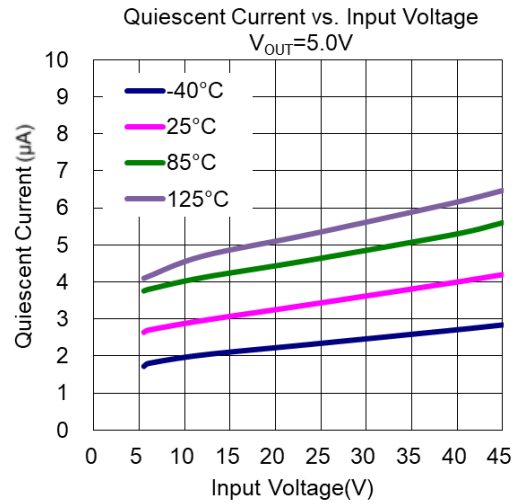
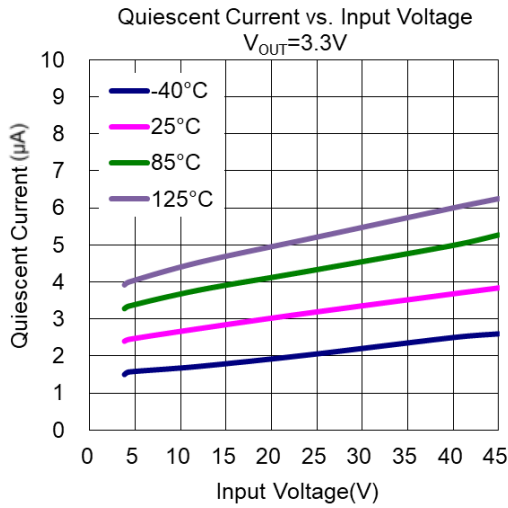

Typical Characteristics (continued)

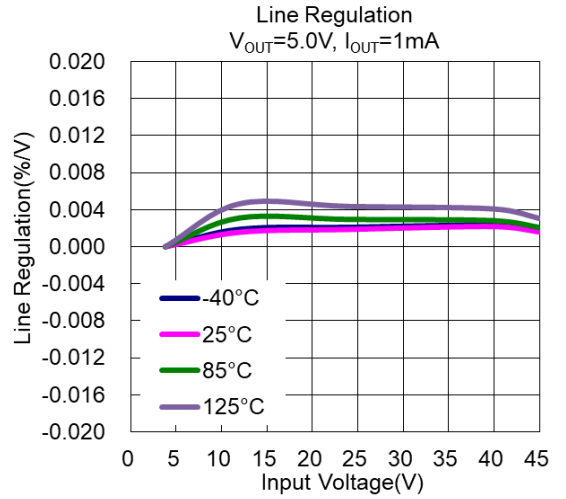
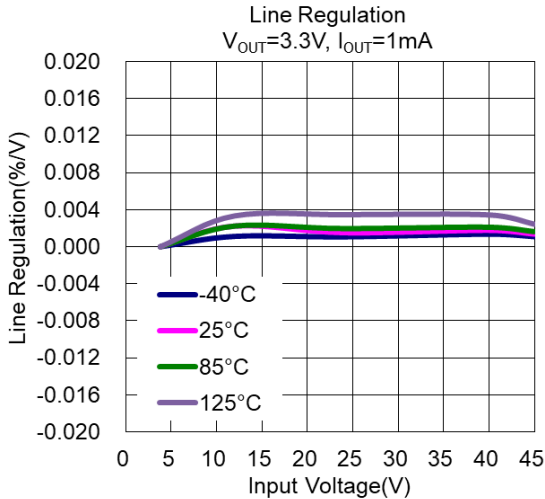
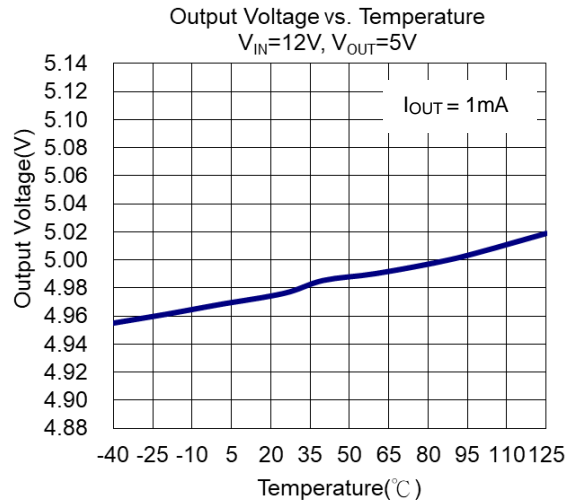
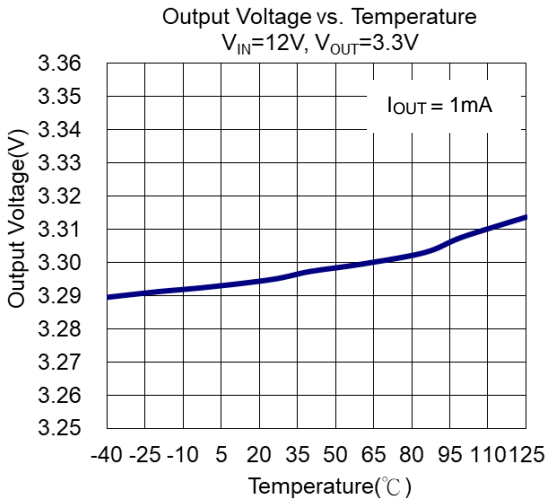
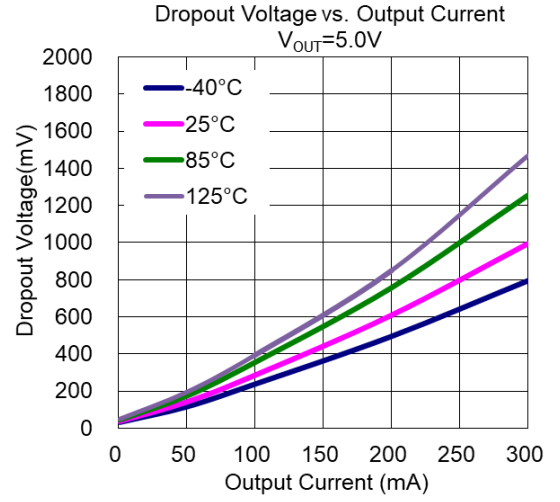
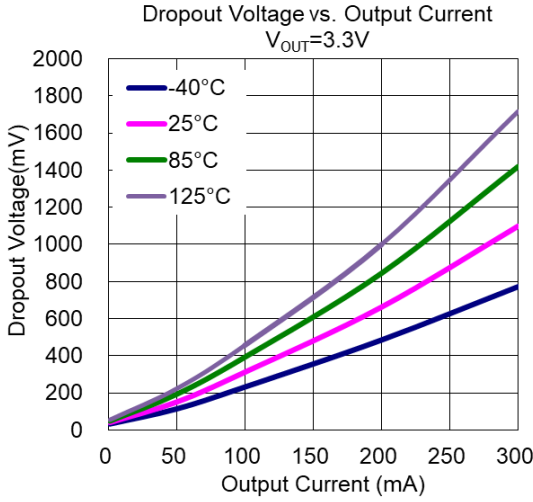

Typical Characteristics (continued)

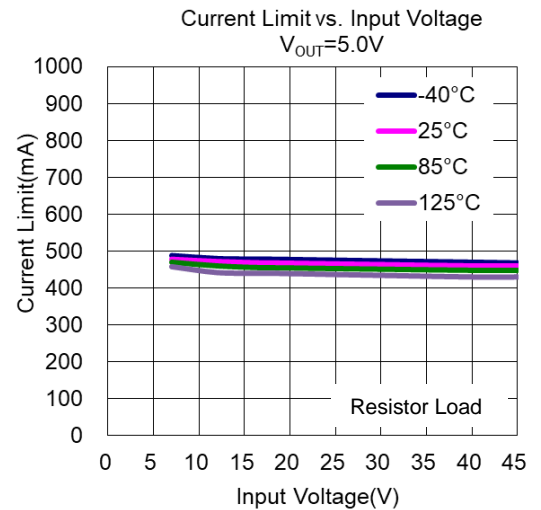
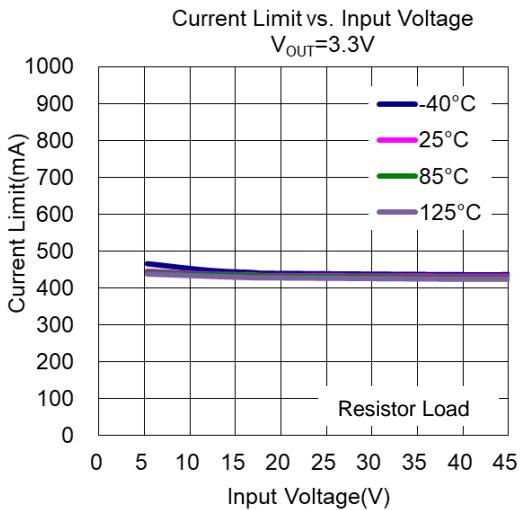
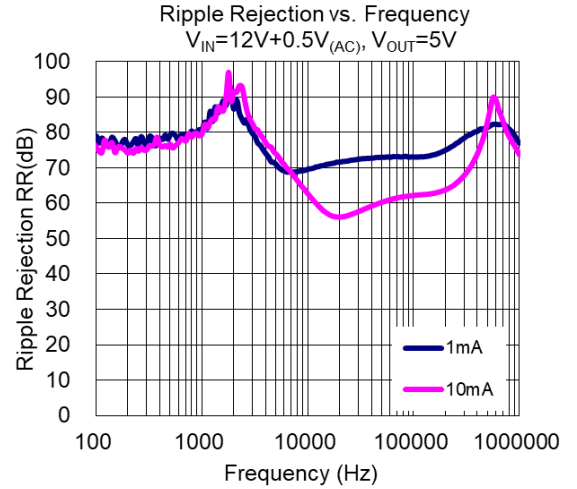
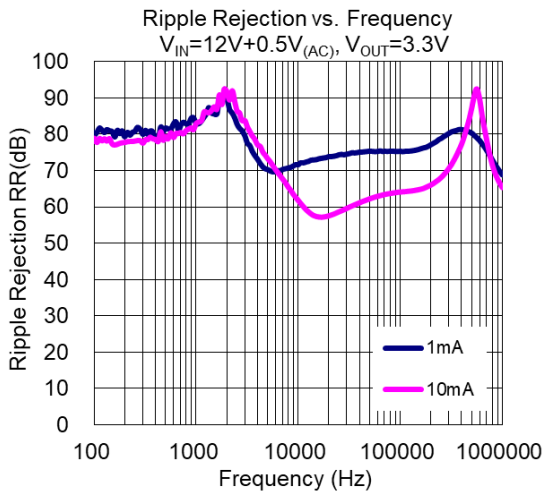
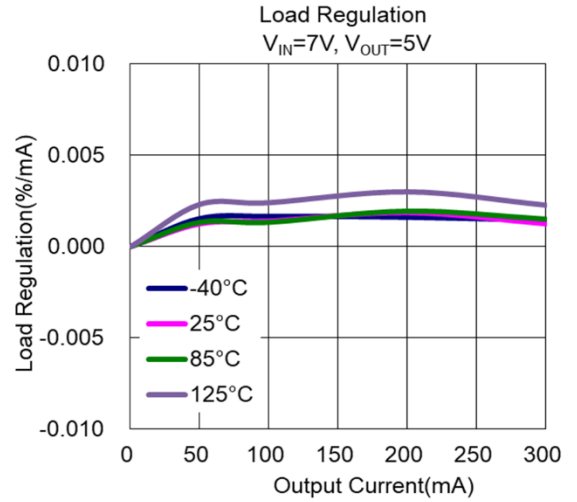
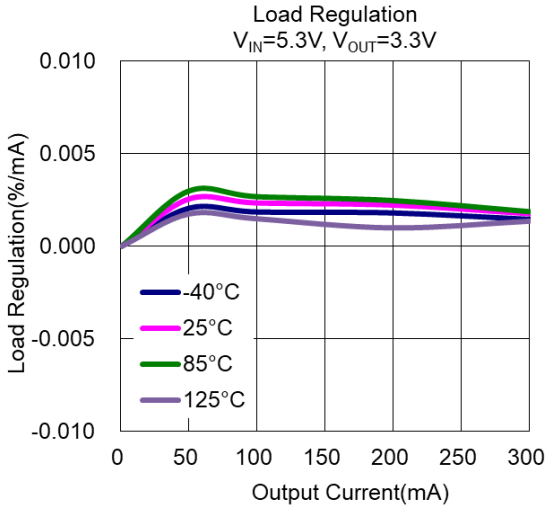

Typical Characteristics (continued)

Power On
 $V_{OUT} = 3.3V$

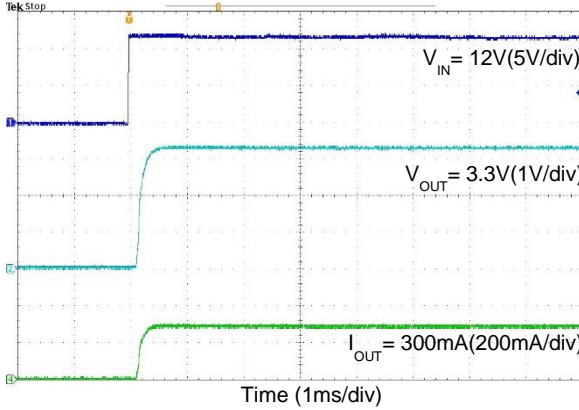

Power On
 $V_{OUT} = 5V$

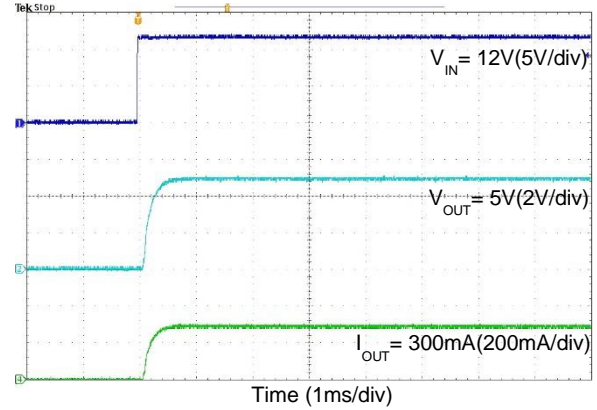

Power Off
 $V_{OUT} = 3.3V$

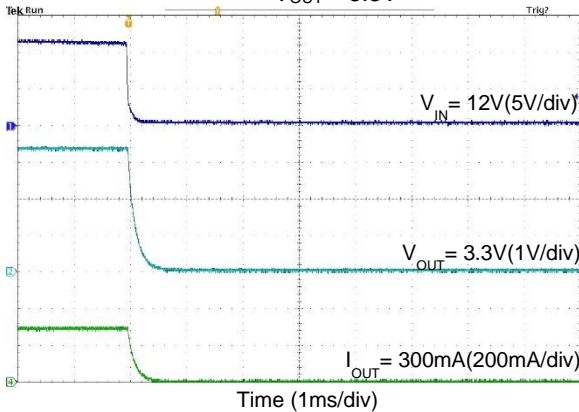

Power Off
 $V_{OUT} = 5V$

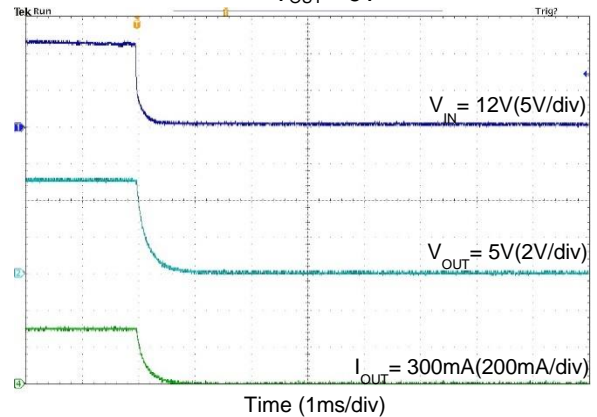

Line Transient Response
 $V_{OUT} = 3.3V$

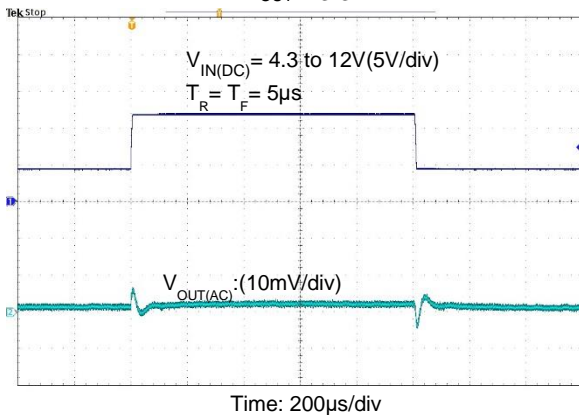

Line Transient Response
 $V_{OUT} = 5V$

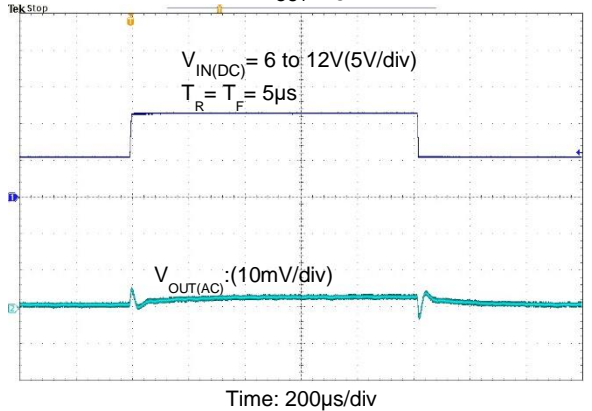

Typical Characteristics (continued)

Load Transient Response
 $V_{OUT} = 3.3V$

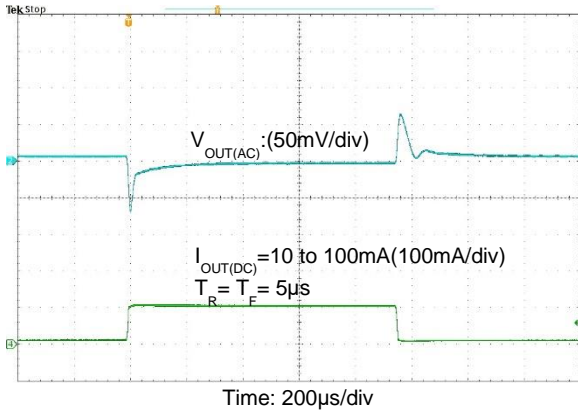

Load Transient Response
 $V_{OUT} = 3.3V$

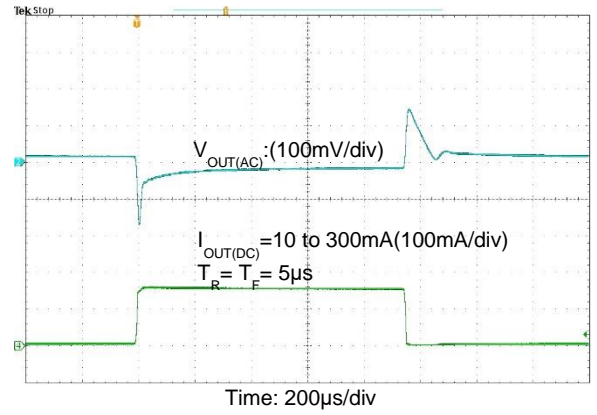

Load Transient Response
 $V_{OUT} = 5V$

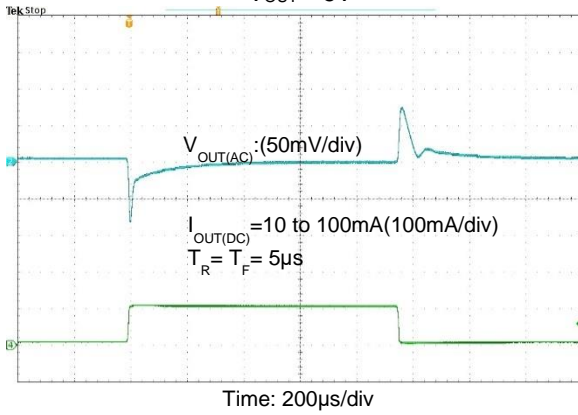

Load Transient Response
 $V_{OUT} = 5V$

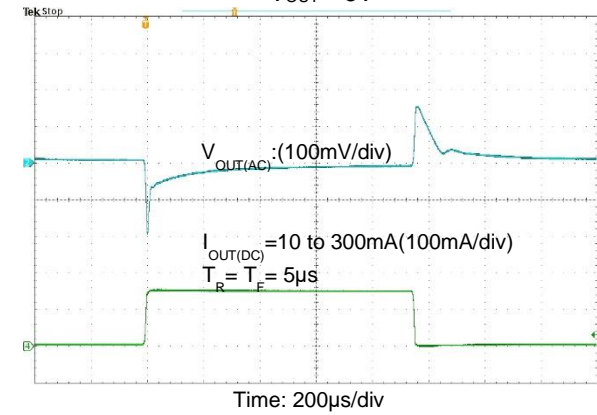

Application Information

Output Capacitor

An output capacitor is required for the stability of the LDO. The recommended minimum output capacitance is 1 μ F. A ceramic capacitor is recommended, and temperature characteristics are X7R or X5R. Higher capacitance values help to improve load/line transient response. The output capacitance may be increased to keep low undershoot/overshoot. Place output capacitor as close as possible to VOUT and GND pins.

Input Capacitor

A 1 μ F ceramic capacitor is recommended to connect between VIN and GND pins to decouple input power supply glitch and noise. The amount of the capacitance may be increased without limit. This input capacitor must be located as close as possible to the device to assure input stability and less noise. For PCB layout, a wide copper trace is required for both VIN and GND.

Current Limit and Short Circuit Protection

When output current at VOUT pin is higher than current-limit threshold or the VOUT pin is direct short to GND, the current-limit protection will be triggered and clamp the output current at a pre-designed level to prevent overcurrent and thermal damage.

Thermal Protection

The AP7375 has internal thermal sense and protection circuits. When excessive power dissipation happens on the device, such as short circuit at the output pin or very heavy load current with a large voltage drop across the device, the internal thermal protection circuit will be triggered, and it will shut down the power MOSFET to prevent the LDO from damage. As soon as excessive thermal condition is removed and the temperature of the device drops down, the thermal protection circuit will lease the control of the power MOSFET, and the LDO device goes to normal operation.

Layout Considerations

For good ground loop and stability, the input and output capacitors should be located close to the input, output, and ground pins of the device. The regulator ground pin should be connected to the external circuit ground to reduce voltage drop caused by trace impedance. Ground plane is generally used to reduce trace impedance. Wide trace should be used for large current paths from VIN to VOUT, and load circuit.

Ordering Information

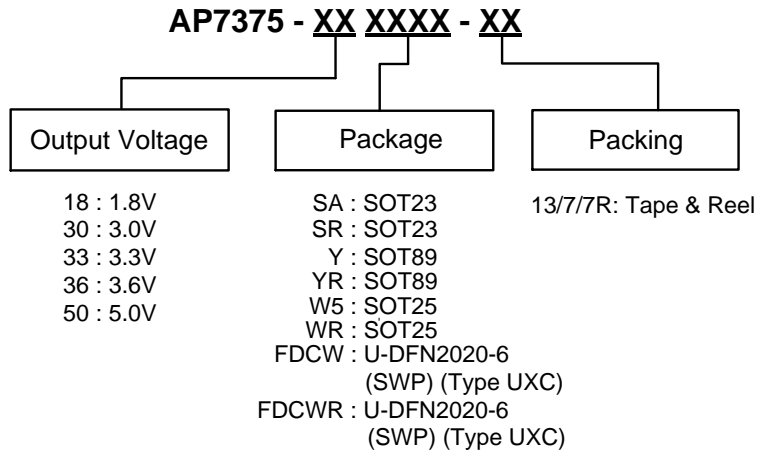

Orderable Part Number	Package Code	Package	Packing	
			Qty.	Carrier
AP7375-XXSA-7	SA	SOT23	3000	7" Tape & Reel
AP7375-XXSR-7 (*)	SR	SOT23	3000	7" Tape & Reel
AP7375-XXY-13	Y	SOT89	2500	13" Tape & Reel
AP7375-XXYR-13 (*)	YR	SOT89	2500	13" Tape & Reel
AP7375-XXW5-7	W5	SOT25	3000	7" Tape & Reel
AP7375-XXWR-7 (*)	WR	SOT25	3000	7" Tape & Reel
AP7375-XXFDCW-7	FDCW	U-DFN2020-6 (SWP) (Type UXC)	3000	7" Tape & Reel
AP7375-XXFDCWR-7R	FDCWR	U-DFN2020-6 (SWP) (Type UXC)	3000	7" Tape & Reel

*Future Product

Marking Information

(1) SOT23

(Top View)

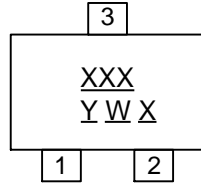

XXX : Identification Code
Y : Year 0 to 9
W : Week : A to Z : 1 to 26 Week;
a to z : 27 to 52 Week; z Represents
52 and 53 Week
X : Internal Code

Orderable Part Number	Package	Identification Code
AP7375-18SA-7	SOT23	H5A
AP7375-30SA-7	SOT23	H5B
AP7375-33SA-7	SOT23	H5C
AP7375-50SA-7	SOT23	H5D
AP7375-33SR-7	SOT23	H5S
AP7375-50SR-7	SOT23	H5T

(2) SOT89

(Top View)

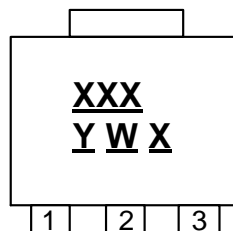

XXX : Identification Code
Y : Year : 0 to 9
W : Week : A to Z : 1 to 26 Week;
a to z : 27 to 52 Week;
z Represents 52 and 53 Week
X : Internal Code

Orderable Part Number	Package	Identification Code
AP7375-18Y-13	SOT89	H5A
AP7375-30Y-13	SOT89	H5B
AP7375-33Y-13	SOT89	H5C
AP7375-50Y-13	SOT89	H5D
AP7375-33YR-13	SOT89	H5S
AP7375-50YR-13	SOT89	H5T

Marking Information (continued)

(3) SOT25

(Top View)

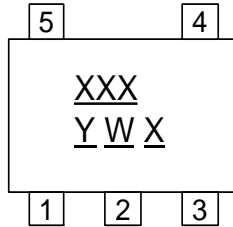

XXX : Identification Code
Y : Year 0 to 9
W : Week A to Z: 1 to 26 Week;
a to z : 27 to 52 Week; z Represents
52 and 53 Week
X : Internal Code

Orderable Part Number	Package	Identification Code
AP7375-18W5-7	SOT25	H5A
AP7375-30W5-7	SOT25	H5B
AP7375-33W5-7	SOT25	H5C
AP7375-36W5-7	SOT25	H5J
AP7375-50W5-7	SOT25	H5D
AP7375-18WR-7	SOT25	H5K
AP7375-30WR-7	SOT25	H5M
AP7375-33WR-7	SOT25	H5N
AP7375-36WR-7	SOT25	H5P
AP7375-50WR-7	SOT25	H5R

(4) U-DFN2020-6 (SWP) (Type UXC)

(Top View)

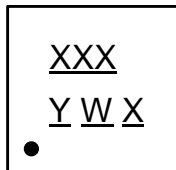

XXX : Identification Code
Y : Year : 0 to 9
W : Week : A to Z : 1 to 26 Week;
a to z : 27 to 52 Week; z Represents
52 and 53 Week
X : Internal Code

Orderable Part Number	Package	Identification Code
AP7375-18FDCW-7	U-DFN2020-6 (SWP) (Type UXC)	H5A
AP7375-30FDCW-7	U-DFN2020-6 (SWP) (Type UXC)	H5B
AP7375-33FDCW-7	U-DFN2020-6 (SWP) (Type UXC)	H5C
AP7375-36FDCW-7	U-DFN2020-6 (SWP) (Type UXC)	H5J
AP7375-50FDCW-7	U-DFN2020-6 (SWP) (Type UXC)	H5D
AP7375-18FDCWR-7R	U-DFN2020-6 (SWP) (Type UXC)	H5K
AP7375-30FDCWR-7R	U-DFN2020-6 (SWP) (Type UXC)	H5M
AP7375-33FDCWR-7R	U-DFN2020-6 (SWP) (Type UXC)	H5N
AP7375-36FDCWR-7R	U-DFN2020-6 (SWP) (Type UXC)	H5P
AP7375-50FDCWR-7R	U-DFN2020-6 (SWP) (Type UXC)	H5R

Package Outline Dimensions

Please see <http://www.diodes.com/package-outlines.html> for the latest version.

(1) SOT23

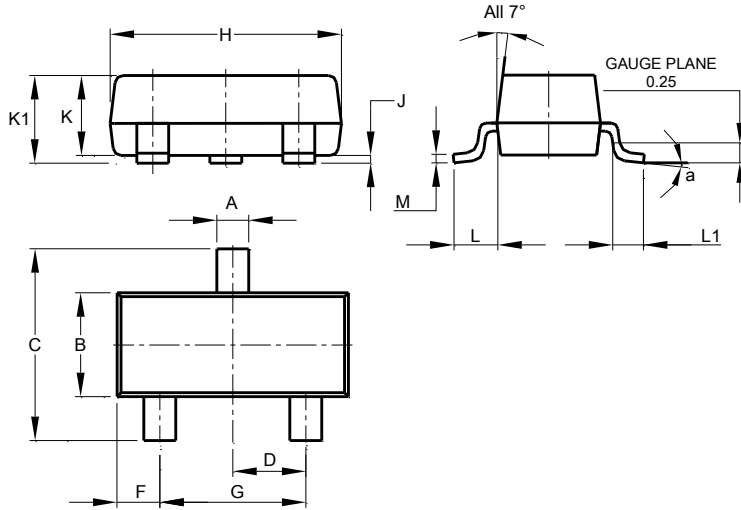

SOT23			
Dim	Min	Max	Typ
A	0.37	0.51	0.40
B	1.20	1.40	1.30
C	2.30	2.50	2.40
D	0.89	1.03	0.915
F	0.45	0.60	0.535
G	1.78	2.05	1.83
H	2.80	3.00	2.90
J	0.013	0.10	0.05
K	0.890	1.00	0.975
K1	0.903	1.10	1.025
L	0.45	0.61	0.55
L1	0.25	0.55	0.40
M	0.085	0.150	0.110
a	0°	8°	--
All Dimensions in mm			

(2) SOT89

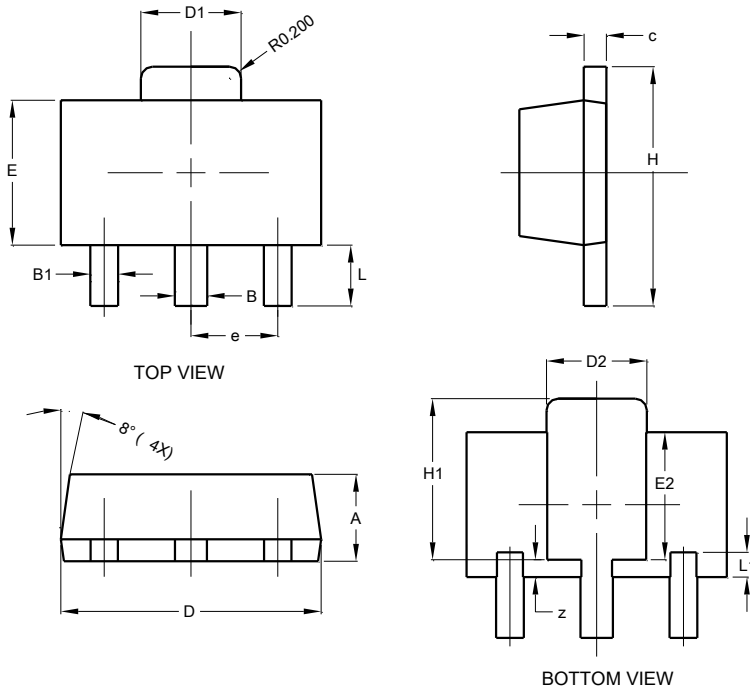

SOT89			
Dim	Min	Max	Typ
A	1.40	1.60	1.50
B	0.50	0.62	0.56
B1	0.42	0.54	0.48
c	0.35	0.43	0.38
D	4.40	4.60	4.50
D1	1.62	1.83	1.733
D2	1.61	1.81	1.71
E	2.40	2.60	2.50
E2	2.05	2.35	2.20
e	-	-	1.50
H	3.95	4.25	4.10
H1	2.63	2.93	2.78
L	0.90	1.20	1.05
L1	0.327	0.527	0.427
z	0.20	0.40	0.30
All Dimensions in mm			

Package Outline Dimensions (continued)

Please see <http://www.diodes.com/package-outlines.html> for the latest version.

(3) SOT25

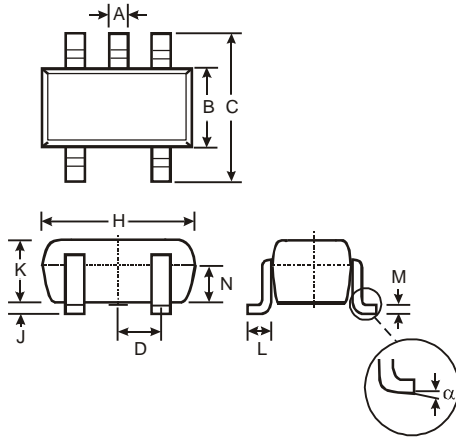

SOT25			
Dim	Min	Max	Typ
A	0.35	0.50	0.38
B	1.50	1.70	1.60
C	2.70	3.00	2.80
D	-	-	0.95
H	2.90	3.10	3.00
J	0.013	0.10	0.05
K	1.00	1.30	1.10
L	0.35	0.55	0.40
M	0.10	0.20	0.15
N	0.70	0.80	0.75
α	0°	8°	-
All Dimensions in mm			

(4) U-DFN2020-6 (SWP) (Type UXC)

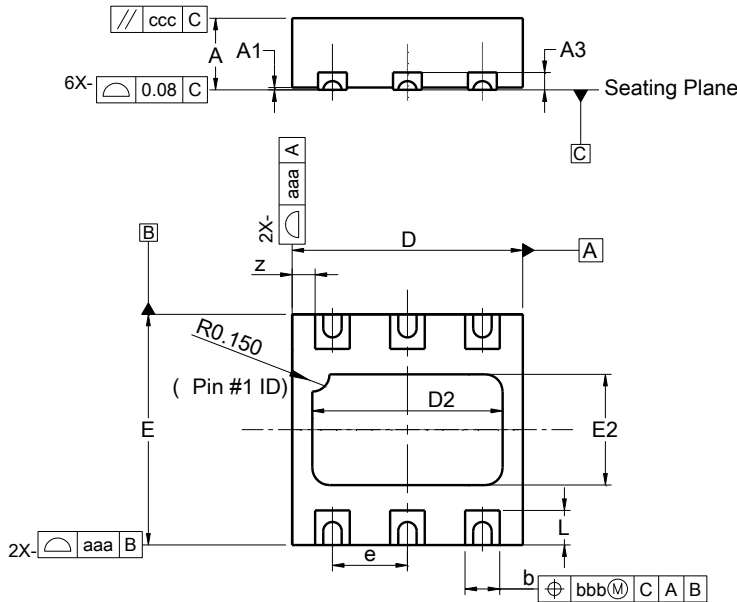

U-DFN2020-6 (SWP) (Type UXC)			
Dim	Min	Max	Typ
A	0.57	0.63	0.60
A1	0.00	0.05	0.02
A3	—	—	0.13
b	0.25	0.35	0.30
D	1.95	2.075	2.00
D2	1.55	1.75	1.65
E	1.95	2.075	2.00
E2	0.86	1.06	0.96
e	—	—	0.65
L	0.25	0.35	0.30
z	—	—	0.20
aaa	0.25		
bbb	0.10		
ccc	0.10		
All Dimensions in mm			

Suggested Pad Layout

Please see <http://www.diodes.com/package-outlines.html> for the latest version.

(1) SOT23

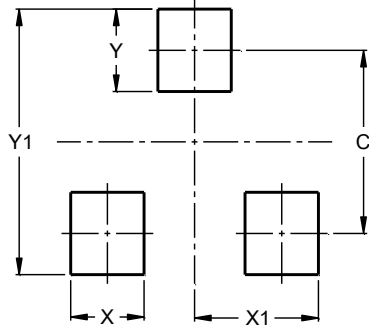

Dimensions	Value (in mm)
C	2.0
X	0.8
X1	1.35
Y	0.9
Y1	2.9

(2) SOT89

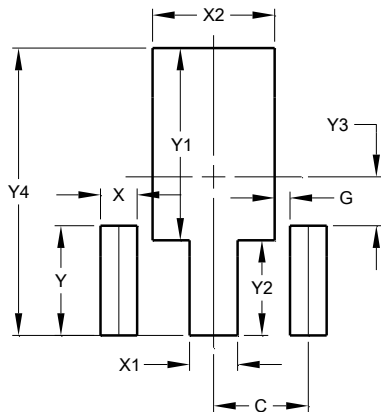

Dimensions	Value (in mm)
C	1.500
G	0.244
X	0.580
X1	0.760
X2	1.933
Y	1.730
Y1	3.030
Y2	1.500
Y3	0.770
Y4	4.530

Suggested Pad Layout (continued)

Please see <http://www.diodes.com/package-outlines.html> for the latest version.

(3) SOT25

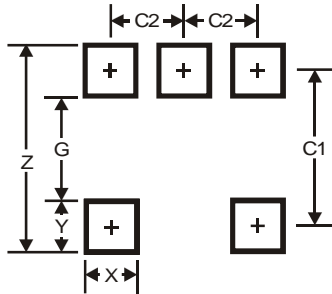

Dimensions	Value
Z	3.20
G	1.60
X	0.55
Y	0.80
C1	2.40
C2	0.95

(4) U-DFN2020-6 (SWP) (Type UXC)

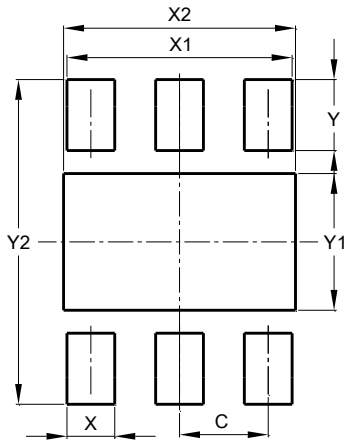

Dimensions	Value (in mm)
C	0.650
X	0.350
X1	1.650
X2	1.700
Y	0.525
Y1	1.010
Y2	2.400

Mechanical Data

- Moisture Sensitivity: Level 1 Per J-STD-020
- Terminals:
 - SOT23/SOT25/SOT89: Finish - Matte Tin Plated Leads, Solderable per MIL-STD-202, Method 208 ^(e3)
 - U-DFN2020-6 (SWP) (Type UXC): Finish – NiPdAu over Copper Leads, Solderable per MIL-STD-202, Method 208 ^(e4)
- Weight:
 - SOT89: 0.054 grams (Approximate)
 - SOT23: 0.009 grams (Approximate)
 - SOT25: 0.018 grams (Approximate)
 - U-DFN2020-6 (SWP) (Type UXC): 0.007 grams (Approximate)

IMPORTANT NOTICE

1. DIODES INCORPORATED (Diodes) AND ITS SUBSIDIARIES MAKE NO WARRANTY OF ANY KIND, EXPRESS OR IMPLIED, WITH REGARDS TO ANY INFORMATION CONTAINED IN THIS DOCUMENT, INCLUDING, BUT NOT LIMITED TO, THE IMPLIED WARRANTIES OF MERCHANTABILITY, FITNESS FOR A PARTICULAR PURPOSE OR NON-INFRINGEMENT OF THIRD PARTY INTELLECTUAL PROPERTY RIGHTS (AND THEIR EQUIVALENTS UNDER THE LAWS OF ANY JURISDICTION).
2. The Information contained herein is for informational purpose only and is provided only to illustrate the operation of Diodes' products described herein and application examples. Diodes does not assume any liability arising out of the application or use of this document or any product described herein. This document is intended for skilled and technically trained engineering customers and users who design with Diodes' products. Diodes' products may be used to facilitate safety-related applications; however, in all instances customers and users are responsible for (a) selecting the appropriate Diodes products for their applications, (b) evaluating the suitability of Diodes' products for their intended applications, (c) ensuring their applications, which incorporate Diodes' products, comply the applicable legal and regulatory requirements as well as safety and functional-safety related standards, and (d) ensuring they design with appropriate safeguards (including testing, validation, quality control techniques, redundancy, malfunction prevention, and appropriate treatment for aging degradation) to minimize the risks associated with their applications.
3. Diodes assumes no liability for any application-related information, support, assistance or feedback that may be provided by Diodes from time to time. Any customer or user of this document or products described herein will assume all risks and liabilities associated with such use, and will hold Diodes and all companies whose products are represented herein or on Diodes' websites, harmless against all damages and liabilities.
4. Products described herein may be covered by one or more United States, international or foreign patents and pending patent applications. Product names and markings noted herein may also be covered by one or more United States, international or foreign trademarks and trademark applications. Diodes does not convey any license under any of its intellectual property rights or the rights of any third parties (including third parties whose products and services may be described in this document or on Diodes' website) under this document.
5. Diodes' products are provided subject to Diodes' Standard Terms and Conditions of Sale (<https://www.diodes.com/about/company/terms-and-conditions/terms-and-conditions-of-sales/>) or other applicable terms. This document does not alter or expand the applicable warranties provided by Diodes. Diodes does not warrant or accept any liability whatsoever in respect of any products purchased through unauthorized sales channel.
6. Diodes' products and technology may not be used for or incorporated into any products or systems whose manufacture, use or sale is prohibited under any applicable laws and regulations. Should customers or users use Diodes' products in contravention of any applicable laws or regulations, or for any unintended or unauthorized application, customers and users will (a) be solely responsible for any damages, losses or penalties arising in connection therewith or as a result thereof, and (b) indemnify and hold Diodes and its representatives and agents harmless against any and all claims, damages, expenses, and attorney fees arising out of, directly or indirectly, any claim relating to any noncompliance with the applicable laws and regulations, as well as any unintended or unauthorized application.
7. While efforts have been made to ensure the information contained in this document is accurate, complete and current, it may contain technical inaccuracies, omissions and typographical errors. Diodes does not warrant that information contained in this document is error-free and Diodes is under no obligation to update or otherwise correct this information. Notwithstanding the foregoing, Diodes reserves the right to make modifications, enhancements, improvements, corrections or other changes without further notice to this document and any product described herein. This document is written in English but may be translated into multiple languages for reference. Only the English version of this document is the final and determinative format released by Diodes.
8. Any unauthorized copying, modification, distribution, transmission, display or other use of this document (or any portion hereof) is prohibited. Diodes assumes no responsibility for any losses incurred by the customers or users or any third parties arising from any such unauthorized use.
9. This Notice may be periodically updated with the most recent version available at <https://www.diodes.com/about/company/terms-and-conditions/important-notice>

The Diodes logo is a registered trademark of Diodes Incorporated in the United States and other countries.
All other trademarks are the property of their respective owners.
© 2024 Diodes Incorporated. All Rights Reserved.

www.diodes.com

Looking for pricing, stock, or lifecycle information?

Click below to explore more details on WIN SOURCE:

 [View AP7375-50W5-7 on WIN SOURCE](#)

 [Diodes Incorporated](#) Information

Optimize Your Supply Chain with WIN SOURCE Solutions

-  Global Sourcing Solution
-  Obsolete Management
-  Cost Control Management
-  Shortage Management
-  Alternative Solution
-  Excess Inventory Management