



**THE DATASHEET OF
DMC261040R**



DMC26104

Silicon NPN epitaxial planar type

For digital circuits

■ Features

- Low collector-emitter saturation voltage $V_{CE(sat)}$
- Halogen-free / RoHS compliant
(EU RoHS / UL-94 V-0 / MSL: Level 1 compliant)

■ Marking Symbol: J2

■ Basic Part Number

Dual DRC2114Y (Common emitter)

■ Packaging

DMC261040R Embossed type (Thermo-compression sealing): 3 000 pcs / reel (standard)

■ Absolute Maximum Ratings $T_a = 25^\circ\text{C}$

Parameter		Symbol	Rating	Unit
Tr1	Collector-base voltage (Emitter open)	V_{CBO}	50	V
	Collector-emitter voltage (Base open)	V_{CEO}	50	V
Tr2	Collector current	I_C	100	mA
Overall	Total power dissipation	P_T	300	mW
	Junction temperature	T_j	150	$^\circ\text{C}$
	Operating ambient temperature	T_{opr}	-40 to +85	$^\circ\text{C}$
	Storage temperature	T_{stg}	-55 to +150	$^\circ\text{C}$

■ Electrical Characteristics $T_a = 25^\circ\text{C} \pm 3^\circ\text{C}$

Parameter	Symbol	Conditions	Min	Typ	Max	Unit
Collector-base voltage (Emitter open)	V_{CBO}	$I_C = 10 \mu\text{A}, I_E = 0$	50			V
Collector-emitter voltage (Base open)	V_{CEO}	$I_C = 2 \text{mA}, I_B = 0$	50			V
Collector-base cutoff current (Emitter open)	I_{CBO}	$V_{CB} = 50 \text{V}, I_E = 0$			0.1	μA
Collector-emitter cutoff current (Base open)	I_{CEO}	$V_{CE} = 50 \text{V}, I_B = 0$			0.5	μA
Emitter-base cutoff current (Collector open)	I_{EBO}	$V_{EB} = 6 \text{V}, I_C = 0$			0.2	mA
Forward current transfer ratio	h_{FE}	$V_{CE} = 10 \text{V}, I_C = 5 \text{mA}$	80			—
h_{FE} ratio *1	h_{FE} (Small/Large)	$V_{CE} = 10 \text{V}, I_C = 5 \text{mA}$	0.50	0.99		—
Collector-emitter saturation voltage	$V_{CE(sat)}$	$I_C = 10 \text{mA}, I_B = 0.5 \text{mA}$			0.25	V
Input voltage (ON)	$V_{I(on)}$	$V_{CE} = 0.2 \text{V}, I_C = 5 \text{mA}$	1.7			V
Input voltage (OFF)	$V_{I(off)}$	$V_{CE} = 5 \text{V}, I_C = 100 \mu\text{A}$			0.5	V
Input resistance	R_1		-30%	10	+30%	k Ω
Resistance ratio	R_1 / R_2		0.17	0.21	0.25	—

Note) 1. Measuring methods are based on JAPANESE INDUSTRIAL STANDARD JIS C 7030 measuring methods for transistors.

2. *1: Ratio between 2 elements

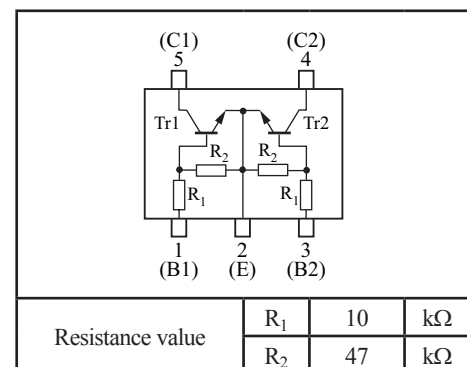
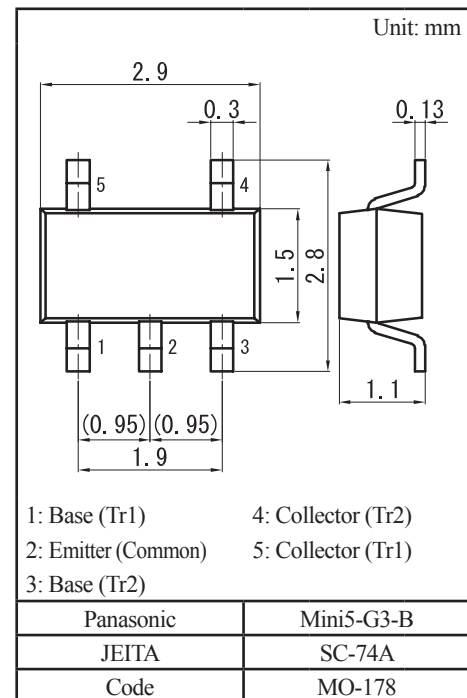

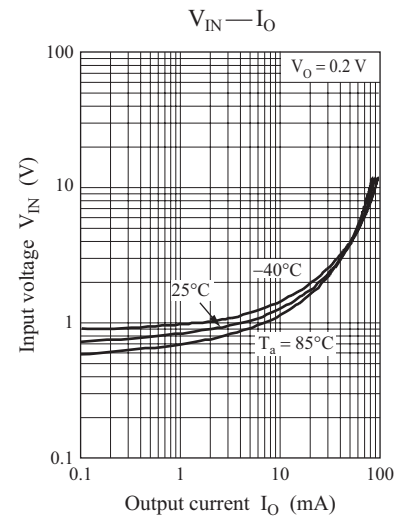
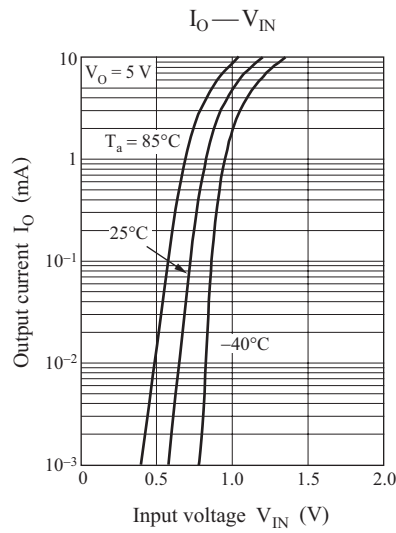
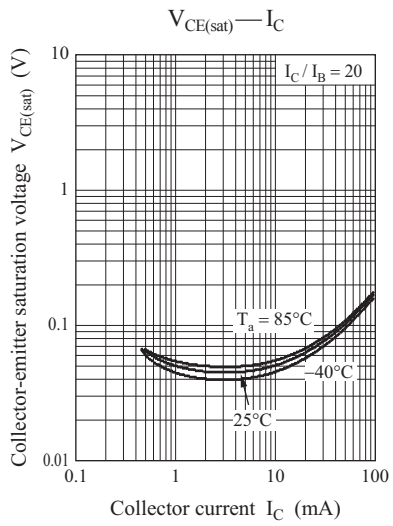
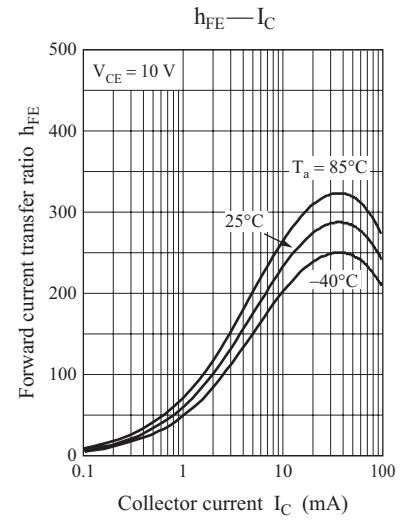
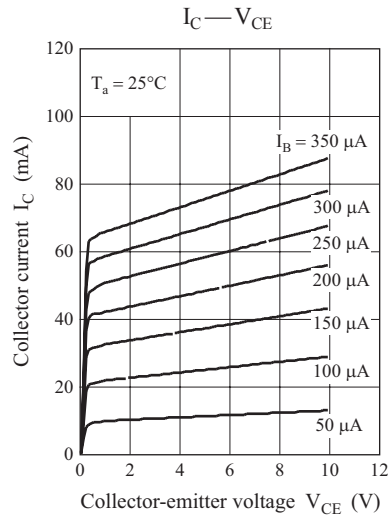
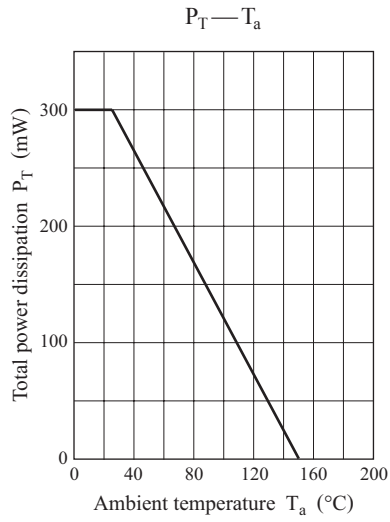

Mini5-G3-B

Unit: mm

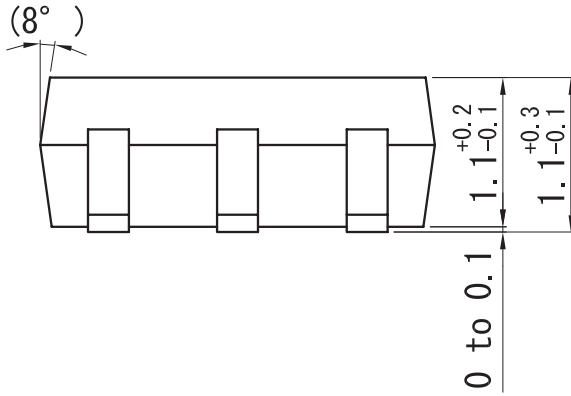
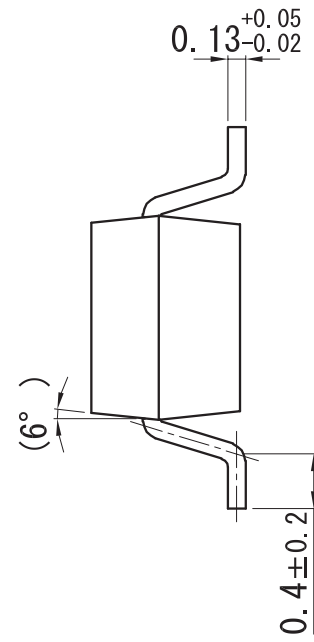
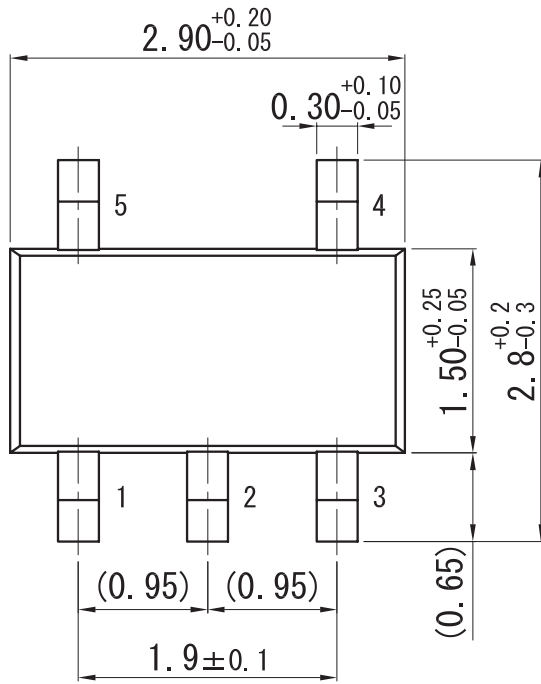

■ Land Pattern (Reference) (Unit: mm)

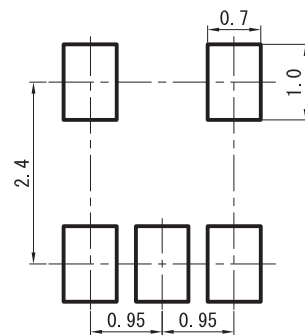

utions in using the technical information and scribed in this book

s book is to be exported or provided to non-residents, the laws and
rd to security export control, must be observed.

ly to show the main characteristics and application circuit examples
roperty right or other right owned by Panasonic Corporation or any
company as to the infringement upon any such right owned by any
l information described in this book.

or general applications (such as office equipment, communications
r for specific applications as expressly stated in this book.

ng applications:

ative equipment, traffic signaling equipment, combustion equipment,
quality and reliability are required, or if the failure or malfunction of
body.

nsible for any damage incurred as a result of or in connection with
pplication, unless our company agrees to your using the products in

k are subject to change without notice for modification and/or im-
use of the products, therefore, ask for the most up-to-date Product
atisfy your requirements.

bsolute maximum rating and the guaranteed operating conditions
(.). Especially, please be careful not to exceed the range of absolute
er-off and mode-switching. Otherwise, we will not be liable for any



take into the consideration of incidence of break down and failure
n the systems such as redundant design, arresting the spread of fire
al injury, fire, social damages, for example, by using the products.

own and characteristics change due to external factors (ESD, EOS,
mounting or at customer's process. When using products for which
shelf life and the elapsed time since first opening the packages.



partially, without the prior written permission of our company.

Looking for pricing, stock, or lifecycle information?

Click below to explore more details on WIN SOURCE:

-  [View DMC261040R on WIN SOURCE](#)
-  [Panasonic Information](#)

Optimize Your Supply Chain with WIN SOURCE Solutions

-  Global Sourcing Solution
-  Obsolete Management
-  Cost Control Management
-  Shortage Management
-  Alternative Solution
-  Excess Inventory Management