



**THE DATASHEET OF  
122416-HMC717LP3**





## GAAS PHEMT MMIC LOW NOISE AMPLIFIER, 4.8 - 6.0 GHz

### Typical Applications

The HMC717LP3E is ideal for:

- Fixed Wireless and LTE/WiMAX/4G
- BTS & Infrastructure
- Repeaters and Femtocells
- Public Safety Radio
- Access Points

### Features

- Noise Figure: 1.1 dB
- Gain: 16.5 dB
- Output IP3: +31.5 dBm
- Single Supply: +3V to +5V
- 16 Lead 3x3mm QFN Package: 9 mm<sup>2</sup>

### Functional Diagram

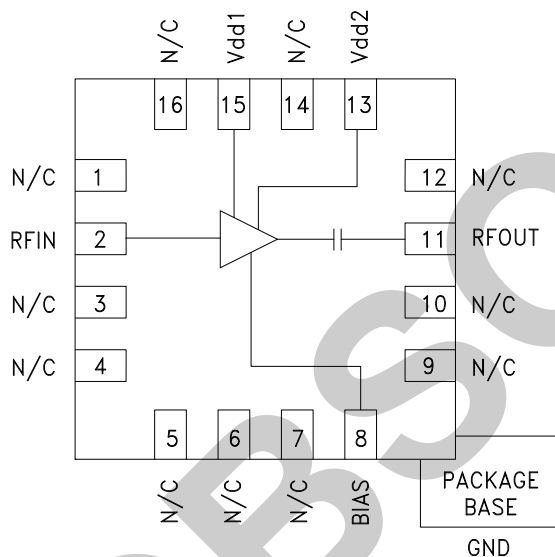

### General Description

The HMC717LP3E is a GaAs PHEMT MMIC Low Noise Amplifier that is ideal for fixed wireless and LTE/WiMAX/4G basestation front-end receivers operating between 4.8 and 6.0 GHz. The amplifier has been optimized to provide 1.1 dB noise figure, 16.5 dB gain and +31.5 dBm output IP3 from a single supply of +5V. Input and output return losses are excellent and the LNA requires minimal external matching and bias decoupling components. The HMC717LP3E can be biased with +3V to +5V and features an externally adjustable supply current which allows the designer to tailor the linearity performance of the LNA for each application.

### Electrical Specifications

$T_A = +25^\circ\text{C}$ ,  $R_{bias} = 2k\text{ Ohms}$  for  $V_{dd} = 5V$ ,  $R_{bias} = 20k\text{ Ohms}$  for  $V_{dd} = 3V$ <sup>[1][2]</sup>

| Parameter                                | Vdd = +3V |      |      | Vdd = +5V         |      |      | Units |
|--|-----------|------|------|-------------------|------|------|-------|
|  | Min.      | Typ. | Max. | Min.              | Typ. | Max. |       |
| Frequency Range                          | 4.8 - 6.0 |      |      | 4.8 - 6.0         |      |      | GHz   |
| Gain                                     | 12        | 14.3 | 21   | 13.5              | 16.5 | 21   | dB    |
| Gain Variation Over Temperature          |           | 0.01 |      |                   | 0.01 |      | dB/°C |
| Noise Figure                             |           | 1.25 | 1.5  |                   | 1.1  | 1.4  | dB    |
| Input Return Loss                        |           | 13   |      |                   | 13   |      | dB    |
| Output Return Loss                       |           | 13   |      |                   | 18   |      | dB    |
| Output Power for 1 dB Compression (P1dB) | 12        | 14   |      | 15                | 18.5 |      | dBm   |
| Saturated Output Power (Psat)            |           | 15   |      |                   | 19.5 |      | dBm   |
| Output Third Order Intercept (IP3)       |           | 25.5 |      | 27 <sup>[3]</sup> | 31.5 |      | dBm   |
| Total Supply Current (Idd)               |           | 31   | 40   |                   | 73   | 100  | mA    |

[1] Rbias resistor sets current, see application circuit herein

[2] Vdd = Vdd1 = Vdd2

[3] Guaranteed by Design at 5GHz.



## GAAS PHEMT MMIC LOW NOISE AMPLIFIER, 4.8 - 6.0 GHz

**Broadband Gain & Return Loss [1][2]**

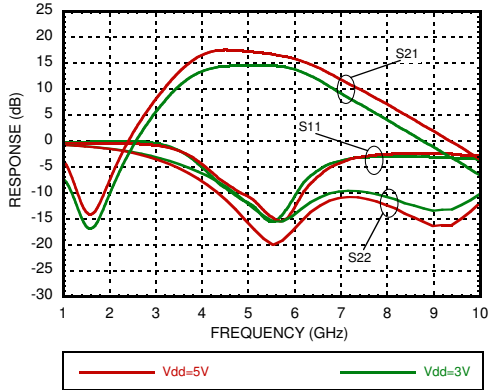

**Gain vs. Temperature [1]**

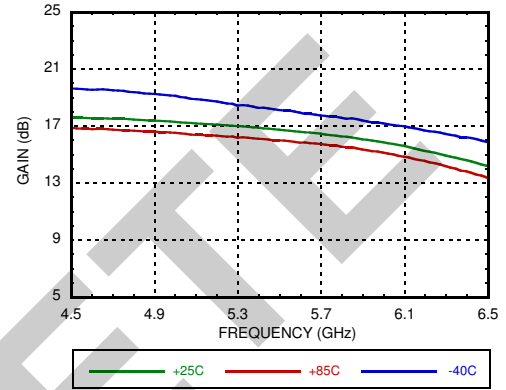

**Gain vs. Temperature [2]**

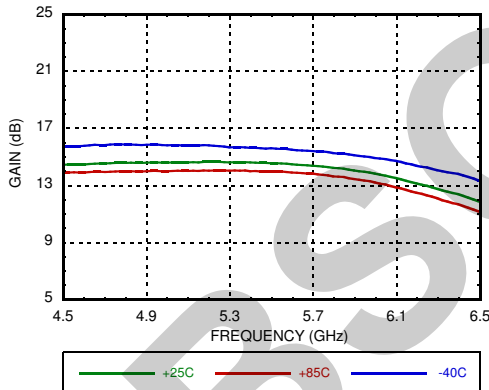

**Input Return Loss vs. Temperature [1]**

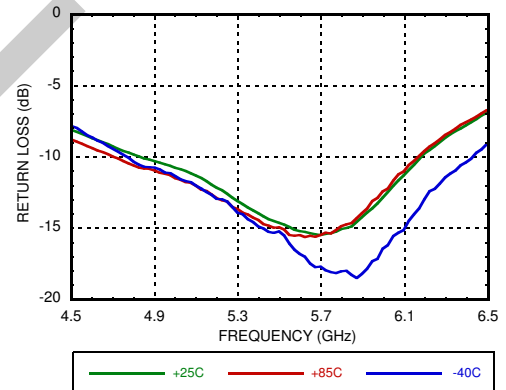

**Output Return Loss vs. Temperature [1]**

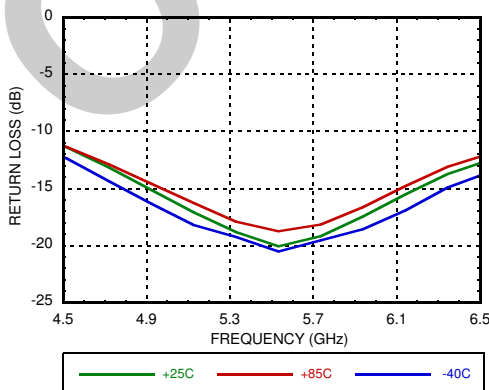

**Reverse Isolation vs. Temperature [1]**

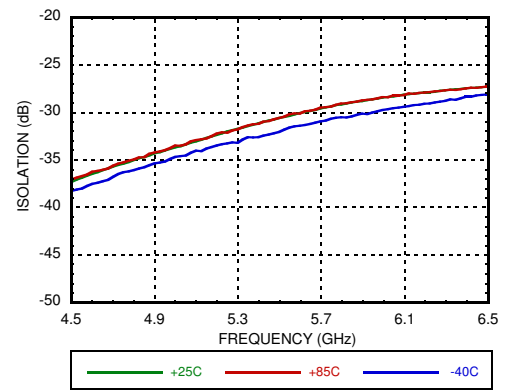

[1] Vdd = 5V, Rbias = 2kΩ [2] Vdd = 3V, Rbias = 20kΩ

## GAAS PHEMT MMIC LOW NOISE AMPLIFIER, 4.8 - 6.0 GHz

AMPLIFIER - LOW NOISE - SMT

**Noise Figure vs. Temperature [1] [2] [4]**

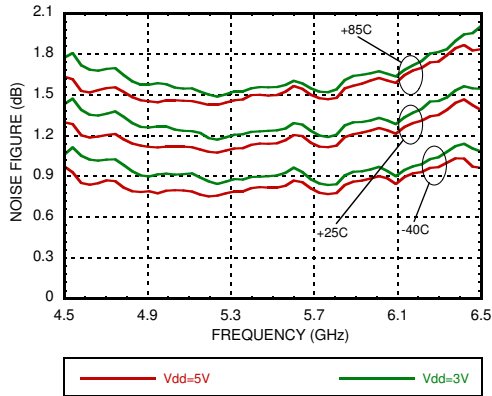

**P1dB vs. Temperature [1] [2]**

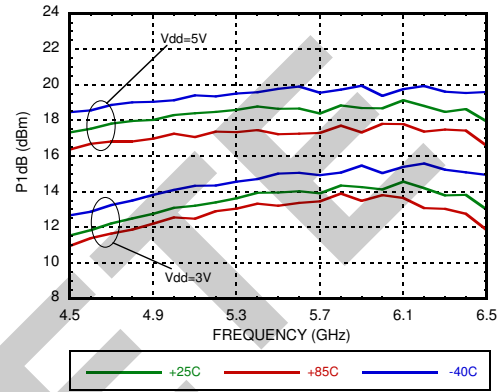

**Psat vs. Temperature [1] [2]**

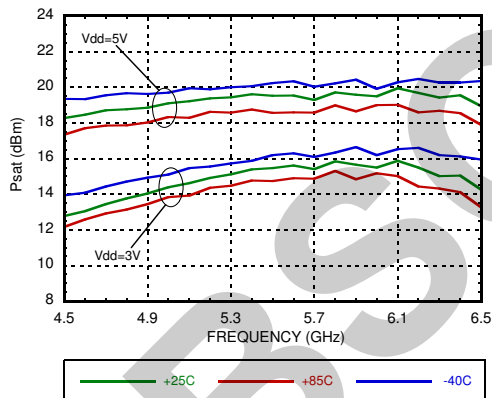

**Output IP3 vs. Temperature [1] [2]**

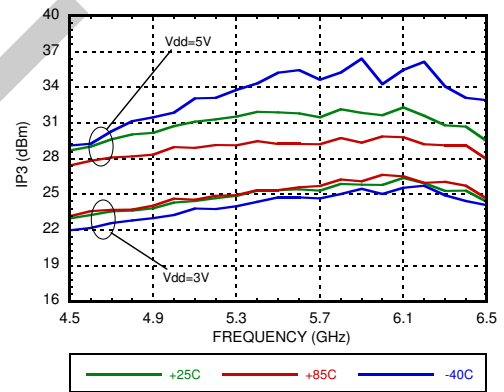

**Output IP3 and Total Supply Current vs. Supply Voltage @ 4800 MHz [3]**

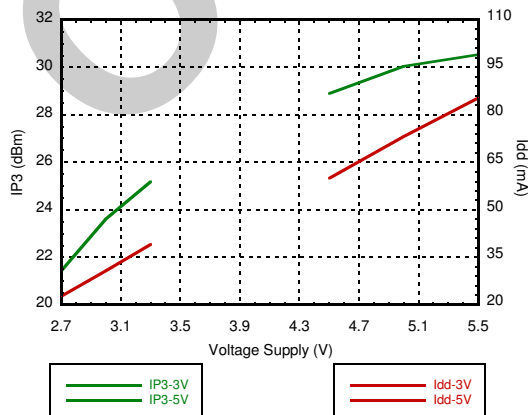

**Output IP3 and Total Supply Current vs. Supply Voltage @ 5900 MHz [3]**

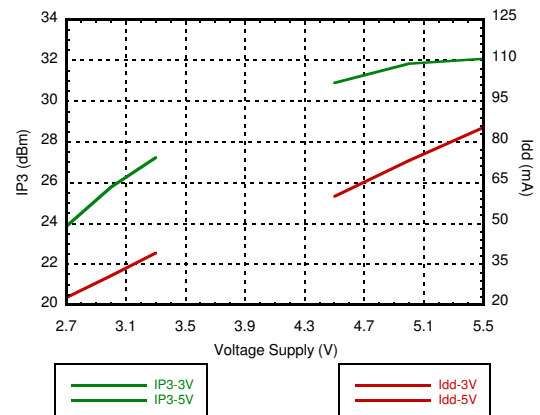

[1] Vdd = 5V, Rbias = 2k  $\Omega$  [2] Vdd = 3V, Rbias = 20k  $\Omega$

[3] Rbias = 2k  $\Omega$  for Vdd = 5V, Rbias = 20k  $\Omega$  for Vdd = 3V

[4] Measurement reference plane shown on evaluation PCB drawing.



## GAAS PHEMT MMIC LOW NOISE AMPLIFIER, 4.8 - 6.0 GHz

**Power Compression @ 4800 MHz [1]**

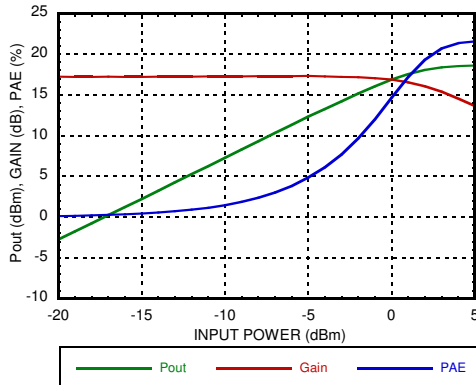

**Power Compression @ 4800 MHz [2]**

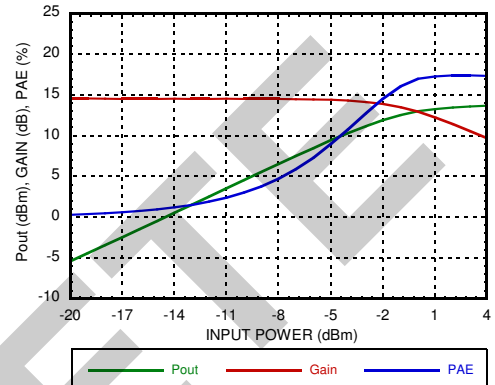

**Power Compression @ 5900 MHz [1]**

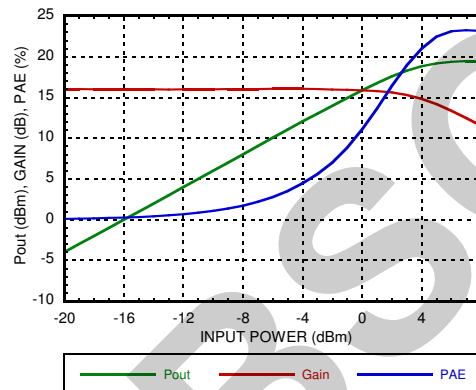

**Power Compression @ 5900 MHz [2]**

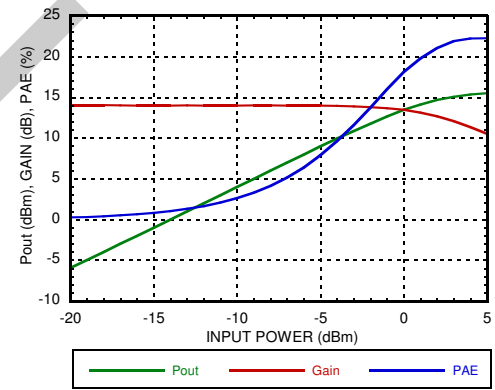

**Gain, Power & Noise Figure vs. Supply Voltage @ 4800 MHz [3]**

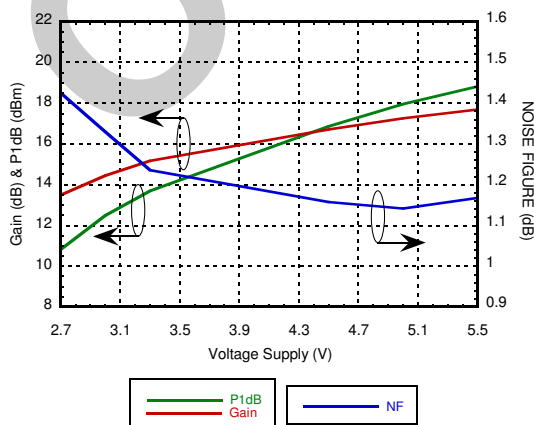

**Gain, Power & Noise Figure vs. Supply Voltage @ 5900 MHz [3]**

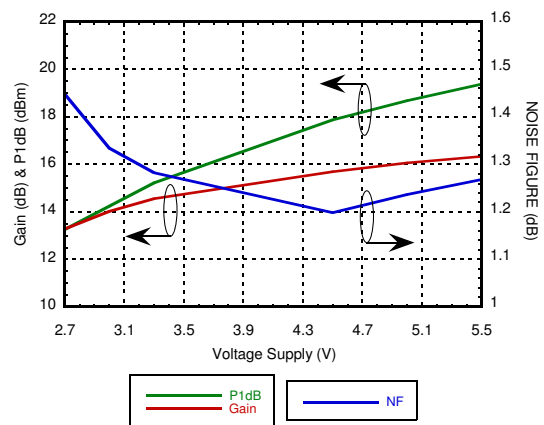

[1] Vdd = 5V, Rbias = 2kΩ [2] Vdd = 3V, Rbias = 20kΩ [3] Rbias = 2kΩ for Vdd = 5V, Rbias = 20kΩ for Vdd = 3V



## GAAS PHEMT MMIC LOW NOISE AMPLIFIER, 4.8 - 6.0 GHz

AMPLIFIER - LOW NOISE - SMT

**Output IP3 vs. Rbias @ 4800 MHz**

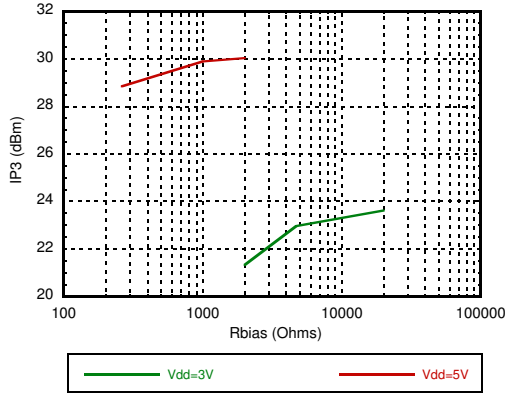

**Gain, Noise Figure & Rbias @ 4800 MHz**

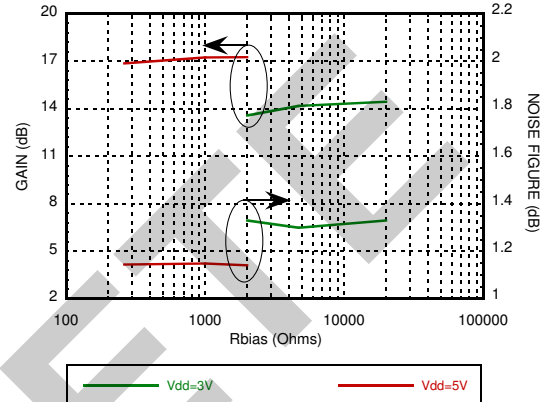

**Output IP3 vs. Rbias @ 5900 MHz**

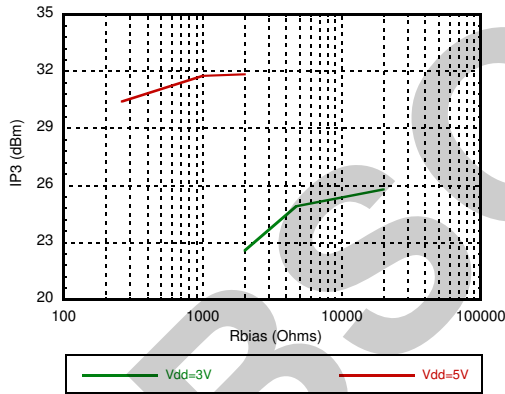

**Gain, Noise Figure & Rbias @ 5900 MHz**

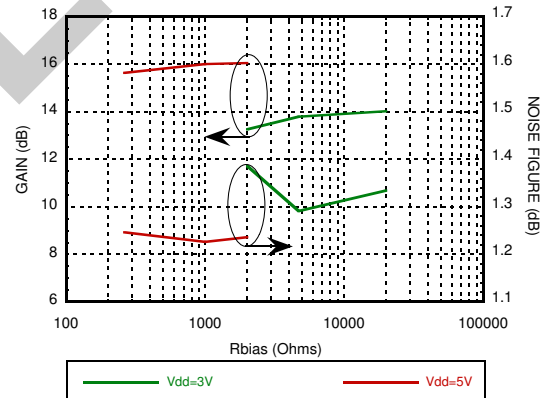

**GAAS PHEMT MMIC LOW NOISE  
AMPLIFIER, 4.8 - 6.0 GHz**
**Absolute Bias Resistor  
Range & Recommended Bias Resistor Values**

| Vdd (V) | Rbias (Ohms)       |              |             | Idd (mA) |
|---------|--------------------|--------------|-------------|----------|
|         | Min                | Max          | Recommended |          |
| 3V      | 2k <sup>[1]</sup>  | Open Circuit | 2k          | 20       |
|         |                    |              | 4.7k        | 26       |
|         |                    |              | 20k         | 31       |
| 5V      | 150 <sup>[2]</sup> | Open Circuit | 261         | 50       |
|         |                    |              | 1k          | 65       |
|         |                    |              | 2k          | 73       |

[1] With Vdd= 3V and Rbias < 2kΩ may result in the part becoming conditionally stable which is not recommended.

[2] With Vdd = 5V and Rbias<150Ω may result in the part becoming conditionally stable which is not recommended.

**Absolute Maximum Ratings**

|  |                |
|--|----------------|
| Drain Bias Voltage (Vdd)                                       | +5.5V          |
| RF Input Power (RFIN)<br>(Vdd = +5 Vdc)                        | +20 dBm        |
| Channel Temperature  | 150 °C         |
| Continuous Pdiss (T= 85 °C)<br>(derate 7.73 mW/°C above 85 °C) | 0.5 W          |
| Thermal Resistance<br>(channel to ground paddle)               | 129.5 °C/W     |
| Storage Temperature  | -65 to +150 °C |
| Operating Temperature  | -40 to +85 °C  |
| ESD Sensitivity (HBM)  | Class 1A       |



ELECTROSTATIC SENSITIVE DEVICE  
OBSERVE HANDLING PRECAUTIONS

**Typical Supply Current vs. Supply Voltage**

(Rbias = 2kΩ for Vdd = 5V, Rbias = 20kΩ for Vdd = 3V)

| Vdd (V) | Idd (mA) |
|---------|----------|
| 2.7     | 23       |
| 3.0     | 31       |
| 3.3     | 39       |
| 4.5     | 60       |
| 5.0     | 73       |
| 5.5     | 85       |

Note: Amplifier will operate over full voltage ranges shown above.

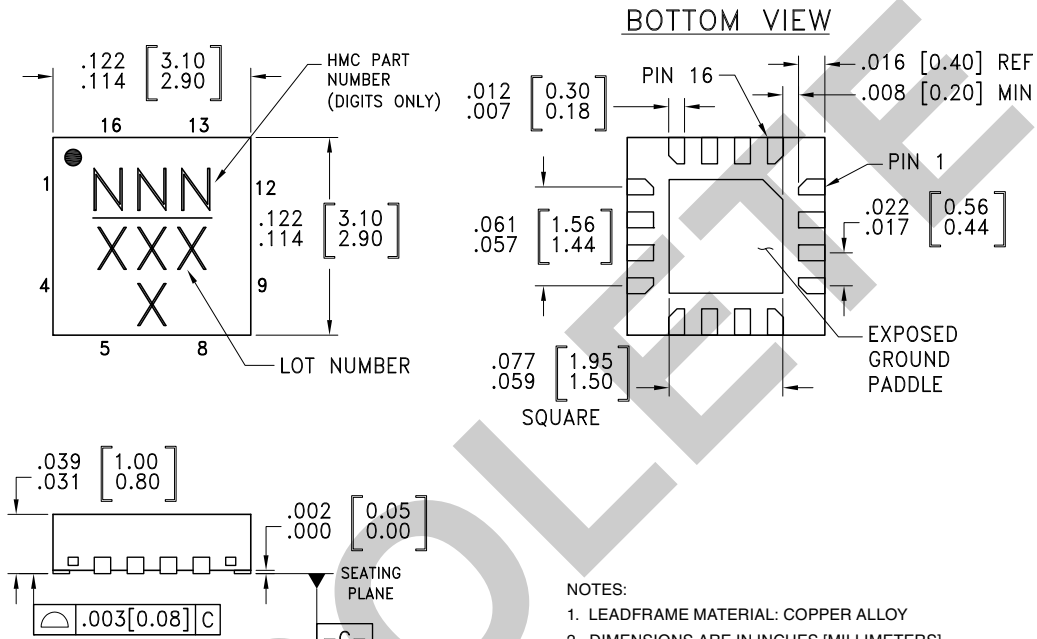
**GAAS PHEMT MMIC LOW NOISE  
AMPLIFIER, 4.8 - 6.0 GHz**
**Outline Drawing**

**NOTES:**

1. LEADFRAME MATERIAL: COPPER ALLOY
2. DIMENSIONS ARE IN INCHES [MILLIMETERS]
3. LEAD SPACING TOLERANCE IS NON-CUMULATIVE
4. PAD BURR LENGTH SHALL BE 0.15mm MAXIMUM.  
PAD BURR HEIGHT SHALL BE 0.05mm MAXIMUM.
5. PACKAGE WARP SHALL NOT EXCEED 0.05mm.
6. ALL GROUND LEADS AND GROUND PADDLE MUST BE SOLDERED TO PCB RF GROUND.
7. REFER TO HITTITE APPLICATION NOTE FOR SUGGESTED LAND PATTERN.

**Package Information**

| Part Number | Package Body Material                              | Lead Finish   | MSL Rating          | Package Marking <sup>[3]</sup> |
|-------------|--|---------------|---------------------|--------------------------------|
| HMC717LP3E  | RoHS-compliant Low Stress Injection Molded Plastic | 100% matte Sn | MSL1 <sup>[2]</sup> | 717<br>XXXX                    |

[1] Max peak reflow temperature of 235 °C



[2] Max peak reflow temperature of 260 °C

[3] 4-Digit lot number XXXX

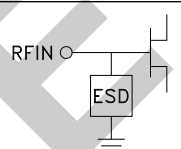
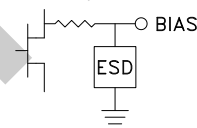
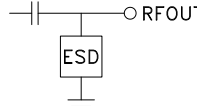
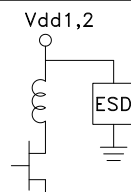

## GAAS PHEMT MMIC LOW NOISE AMPLIFIER, 4.8 - 6.0 GHz

### Pin Descriptions

| Pin Number                  | Function   | Description  | Interface Schematic   |
|-----------------------------|------------|--|---|
| 1, 3 - 7, 9, 10, 12, 14, 16 | N/C        | No connection required. These pins may be connected to RF/DC ground without affecting performance.                           |   |
| 2                           | RFIN       | This pin is DC coupled<br>See the application circuit for off-chip component.  |    |
| 8                           | BIAS       | This pin is used to set the DC current of the amplifier by selection of the external bias resistor. See application circuit. |    |
| 11                          | RFOUT      | This pin is AC coupled and matched to 50 Ohms  |    |
| 13, 15                      | Vdd2, Vdd1 | Power supply voltage. Bypass capacitors are required. See application circuit.   |   |
|                             | GND        | Package bottom must be connected to RF/DC ground   |  |

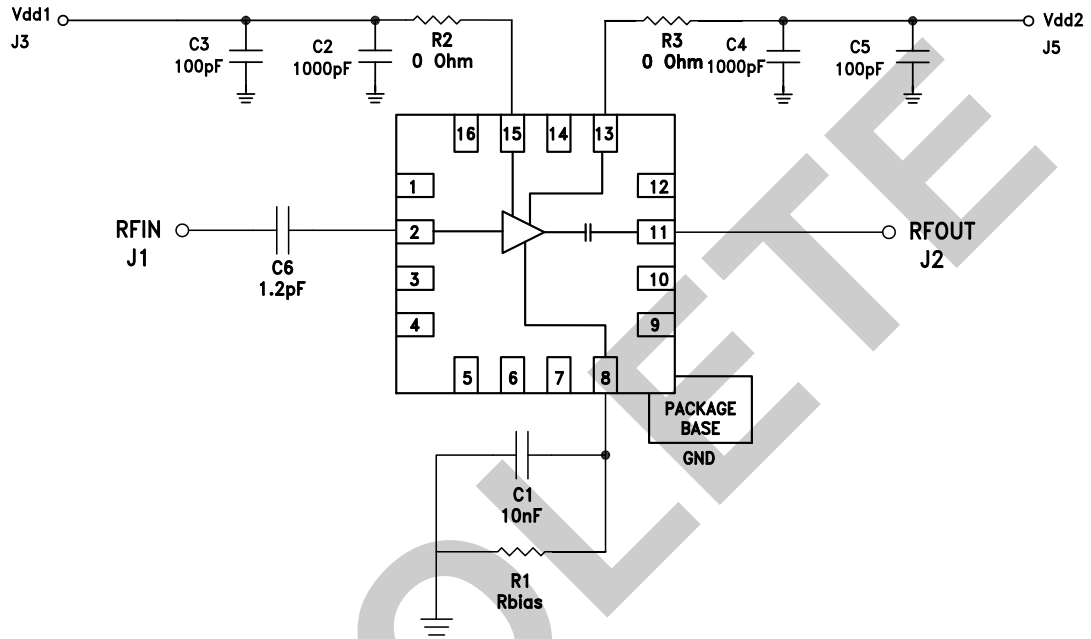
**GAAS PHEMT MMIC LOW NOISE  
AMPLIFIER, 4.8 - 6.0 GHz**
**Application Circuit**

AMPLIFIER - LOW NOISE - SMT

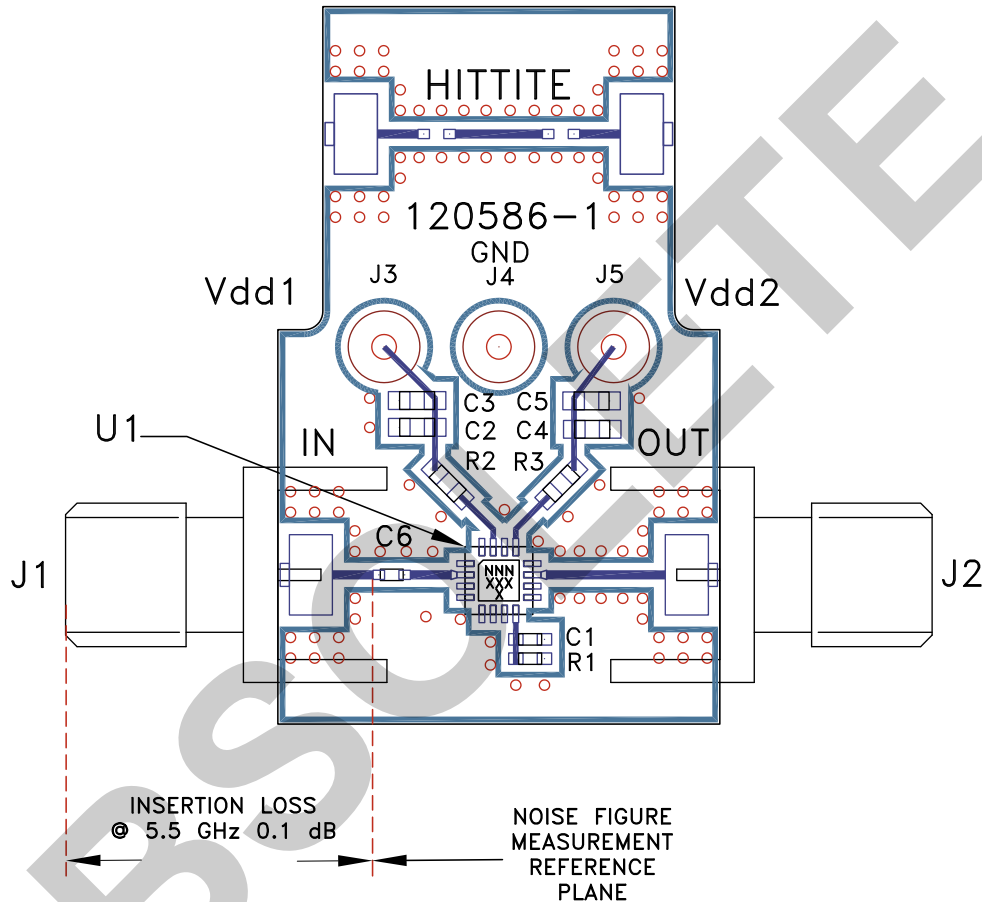
**Evaluation PCB**

**List of Materials for Evaluation PCB 122416 [1]**

| Item    | Description                        |
|---------|------------------------------------|
| J1, J2  | PCB Mount SMA Connector            |
| J3 - J5 | DC Pins                            |
| C1      | 10 nF Capacitor, 0402 Pkg.         |
| C2, C4  | 1000 pF Capacitor, 0603 Pkg.       |
| C3, C5  | 100 pF Capacitor, 0603 Pkg.        |
| C6      | 1.2 pF Capacitor, 0402 Pkg.        |
| R1      | 2k Ohm Resistor, 0402 Pkg. (Rbias) |
| R2, R3  | 0 Ohm Resistor, 0402 Pkg.          |
| U1      | HMC717LP3E Amplifier               |
| PCB [2] | 120586 Evaluation PCB              |

[1] Reference this number when ordering complete evaluation PCB

[2] Circuit Board Material: Rogers 4350.

The circuit board used in this application should use RF circuit design techniques. Signal lines should have 50 Ohm impedance while the package ground leads and exposed paddle should be connected directly to the ground plane similar to that shown. A sufficient number of via holes should be used to connect the top and bottom ground planes. The evaluation board should be mounted to an appropriate heat sink. The evaluation circuit board shown is available from Hittite upon request.

## Looking for pricing, stock, or lifecycle information?

Click below to explore more details on WIN SOURCE:

 [View 122416-HMC717LP3 on WIN SOURCE](#)

 [Analog Devices Inc. Information](#)

## Optimize Your Supply Chain with WIN SOURCE Solutions

-  Global Sourcing Solution
-  Obsolete Management
-  Cost Control Management
-  Shortage Management
-  Alternative Solution
-  Excess Inventory Management