



**THE DATASHEET OF
AP7384-50SA-7**



Description

The DIODES™ AP7384 series is a positive voltage regulator IC.

The AP7384 has features of wide input voltage range, high accuracy, low dropout voltage, current limit and ultra-low quiescent current which make it ideal for use in various USB and portable devices.

The IC consists of a voltage reference, an error amplifier, a resistor network for setting output voltage, a current limit circuit for current protection, and a chip enable circuit.

The AP7384 has 2.8V, 3.3V, 5V and 7V fixed voltage version.

The AP7384 is available in space-saving SOT89, SOT23 and TO92 (Ammo Packing) packages.

Features

- Wide Input Voltage Range: Up to 40V
- Low Dropout Voltage: $V_{DROP} = 500mV @ I_{OUT} = 50mA$
@ $V_{OUT} = 3.3V$
- Low Ground Current
- High Output Voltage Accuracy
- Compatible with Low ESR Ceramic Capacitor
- Excellent Line/Load Regulation
- Thermal Shutdown Function
- Short Current Protection Function
- **Totally Lead-Free & Fully RoHS Compliant (Notes 1 & 2)**
- **Halogen and Antimony Free. "Green" Device (Note 3)**
- **For automotive applications requiring specific change control (i.e. parts qualified to AEC-Q100/101/104/200, PPAP capable, and manufactured in IATF 16949 certified facilities), please [contact us](#) or your local Diodes representative. <https://www.diodes.com/quality/product-definitions/>**

Applications

- E-meters
- Battery-powered equipments
- Laptop, palmtops, notebook computers
- Portable information appliances

- Notes:
1. No purposely added lead. Fully EU Directive 2002/95/EC (RoHS), 2011/65/EU (RoHS 2) & 2015/863/EU (RoHS 3) compliant.
 2. See <https://www.diodes.com/quality/lead-free/> for more information about Diodes Incorporated's definitions of Halogen- and Antimony-free, "Green" and Lead-free.
 3. Halogen- and Antimony-free "Green" products are defined as those which contain <900ppm bromine, <900ppm chlorine (<1500ppm total Br + Cl) and <1000ppm antimony compounds.

Pin Assignments

(Top View)

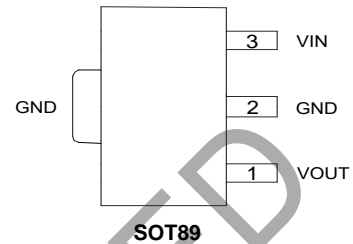

(Top View)

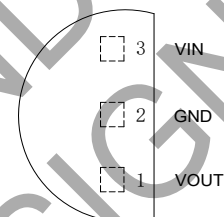

TO92 (Ammo Packing)

(Top View)

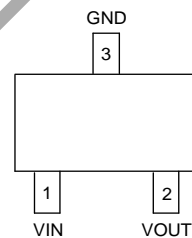

SOT23

Typical Applications Circuit

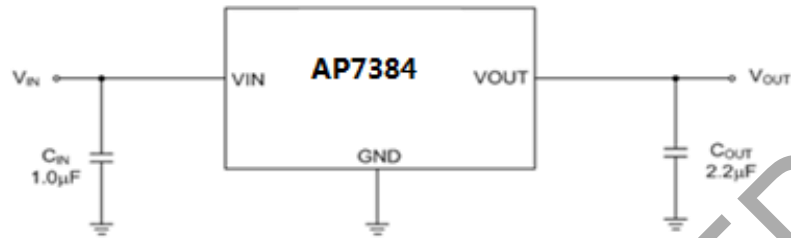

Pin Descriptions

| Pin Number | | | Pin Name | Function |
|-------------------------|-------|-------|----------|--------------------------|
| TO92 (Ammo Packing) | SOT89 | SOT23 | | |
| 3 | 3 | 1 | VIN | Input voltage |
| 2 | 2 | 3 | GND | Ground |
| 1 | 1 | 2 | VOUT | Regulated output voltage |

Absolute Maximum Ratings

| Symbol | Parameter | Rating | Unit | |
|-------------------|-------------------------------------|----------------------|------|------|
| V _{IN} | Supply Input Voltage | 45 | V | |
| I _{OUT} | Output Current | 50 | mA | |
| T _{LEAD} | Lead Temperature (Soldering, 10sec) | +260 | °C | |
| T _J | Operating Junction Temperature | +150 | °C | |
| θ _{JA} | Thermal Resistance | SOT89 | 125 | °C/W |
| | | TO92 (Ammo Packing) | 165 | |
| | | SOT23 | 166 | |
| T _{STG} | Storage Temperature Range | -65 to +150 | °C | |
| CDM | ESD (Change Device Model) | 2000 | V | |
| HBM | ESD (Human Body Model) | 4000 | V | |

Recommended Operating Conditions

| Symbol | Parameter | Min | Max | Unit |
|-----------------|--------------------------------|-----|------|------|
| V _{IN} | Supply Input Voltage | 3.3 | 40 | V |
| T _J | Operating Junction Temperature | -40 | +125 | °C |

Electrical Characteristics ($T_J = +25^\circ\text{C}$, $I_{\text{OUT}} = 1\text{mA}$, $C_{\text{IN}} = 1.0\mu\text{F}$, $C_{\text{OUT}} = 2.2\mu\text{F}$, $V_{\text{IN}} = V_{\text{OUT}} + 2\text{V}$, **Bold** typeface applies over $-40^\circ\text{C} \leq T_J \leq +125^\circ\text{C}$, unless otherwise specified.)

| Symbol | Parameter | Test Conditions | Min | Typ | Max | Unit |
|--|--|--|------------------------------|-----------------------------|-------------------------------|-----------------------|
| V_{OUT} | Output Voltage | Variation from Specified V_{OUT} | $V_{\text{OUT}} \times 98\%$ | — | $V_{\text{OUT}} \times 102\%$ | V |
| V_{IN} | Input Voltage | — | 3.3 | — | 40 | V |
| I_{LIMIT} | Current Limit | $V_{\text{OUT}} = 98\% \times V_{\text{OUT}}$, $V_{\text{IN}} = V_{\text{OUT}} + 2\text{V}$ | 50 | — | — | mA |
| $\Delta V_{\text{OUT}}/\Delta V_{\text{IN}}$ | Line Regulation | $V_{\text{OUT}} + 2\text{V} \leq V_{\text{IN}} \leq 40\text{V}$, $I_{\text{OUT}} = 10\text{mA}$ | — | 0.05 | — | %/V |
| $\Delta V_{\text{OUT}}/V_{\text{OUT}}$ | Load Regulation | $1\text{mA} \leq I_{\text{OUT}} \leq 50\text{mA}$ | — | 0.5 | — | % |
| V_{DROP} | Dropout Voltage | $I_{\text{OUT}} = 50\text{mA}$ @ $V_{\text{OUT}} = 3.3\text{V}$ | — | 500 | — | mV |
| I_{GND} | Ground Current | $I_{\text{OUT}} = 0\text{A}$ | — | 2.5 | — | μA |
| | | $I_{\text{OUT}} = 50\text{mA}$ | — | 25 | — | |
| $\Delta V_{\text{OUT}}/(V_{\text{OUT}}\Delta T)$ | Output Voltage Temperature Coefficient | $I_{\text{OUT}} = 100\mu\text{A}$, $-40^\circ\text{C} \leq T_J \leq +125^\circ\text{C}$ | — | ± 100 | — | ppm/ $^\circ\text{C}$ |
| T_{OTSD} | Thermal Shutdown Temperature | — | — | +160 | — | $^\circ\text{C}$ |
| T_{HYOTSD} | Thermal Shutdown Hysteresis | — | — | +20 | — | $^\circ\text{C}$ |
| PSRR | Power Supply Rejection Ratio | $I_{\text{OUT}} = 1\text{mA}$, $V_{\text{OUT}} = 3.3\text{V}$ | — | 60 | — | dB |

NOT RECOMMENDED FOR NEW DESIGN

Performance Characteristics

Output Voltage vs. Input Voltage @-40°C

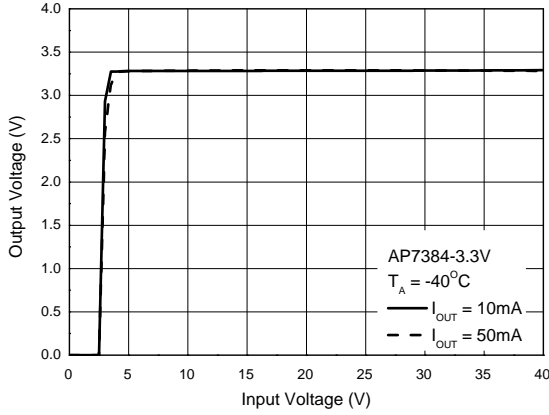

Output Voltage vs. Input Voltage @+25°C

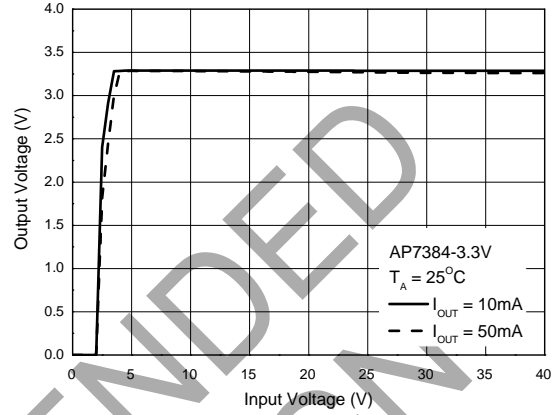

Output Voltage vs. Input Voltage @+85°C

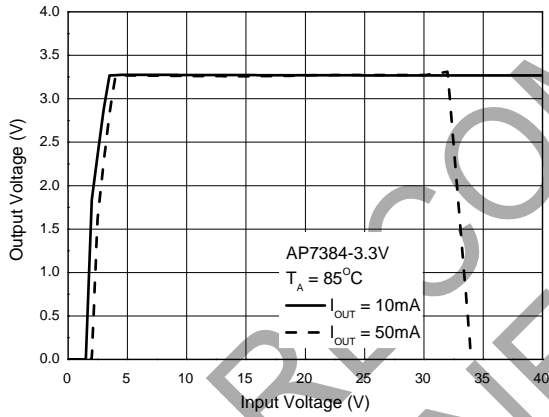

Output Voltage vs. Output Current

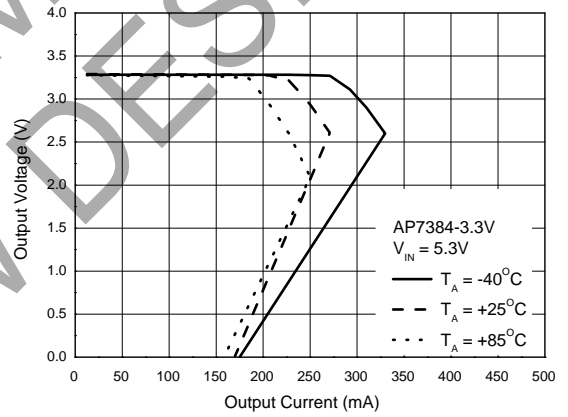

Output Voltage vs. Temperature

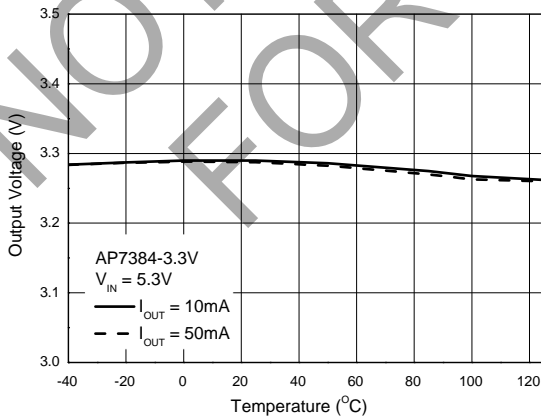

Output Voltage vs. Output Current

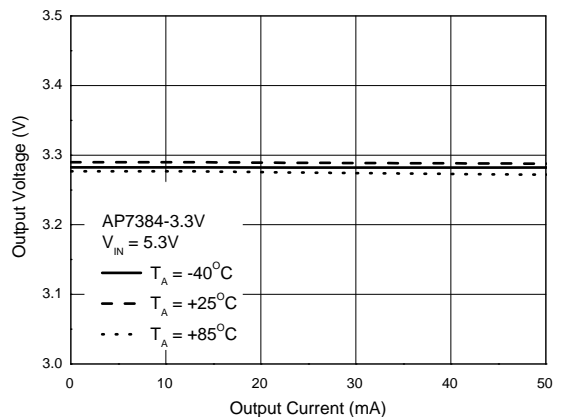

Performance Characteristics (continued)

Dropout Voltage vs. Output Current

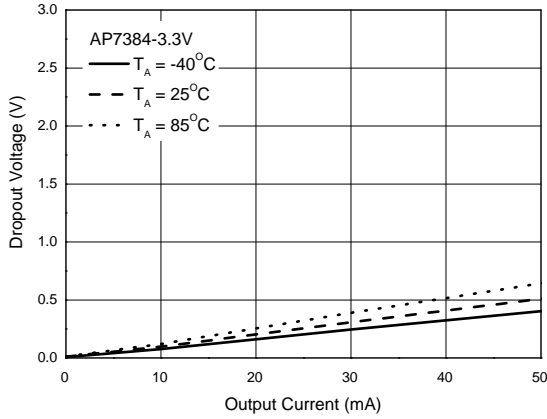

Dropout Voltage vs. Temperature

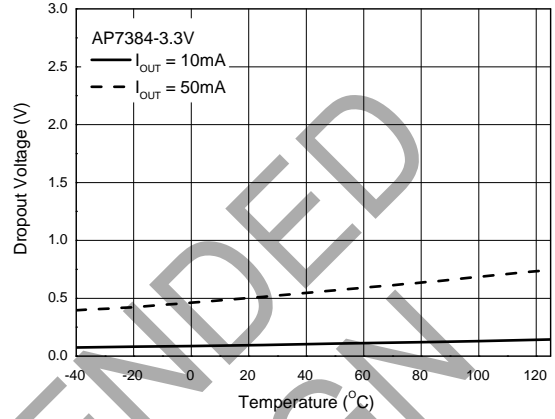

I_{GND} vs. Input Voltage

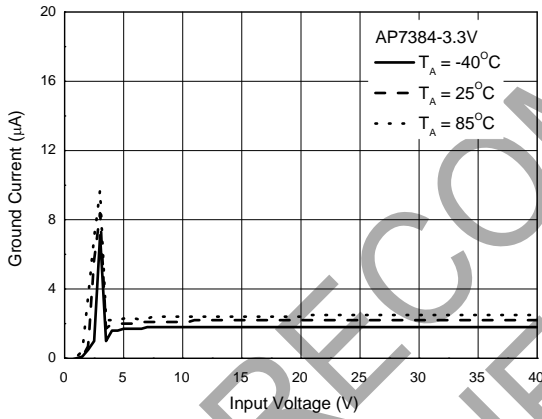

I_{GND} vs. Output Current

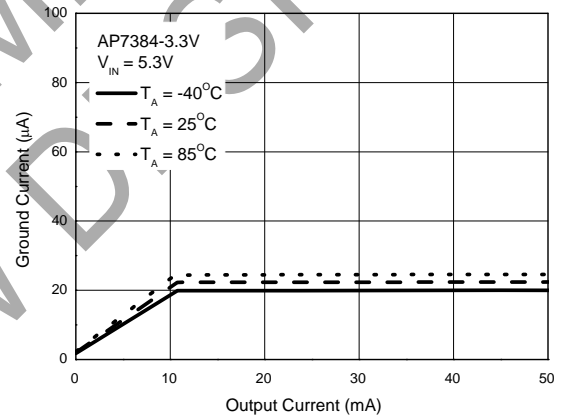

I_{GND} vs. Temperature

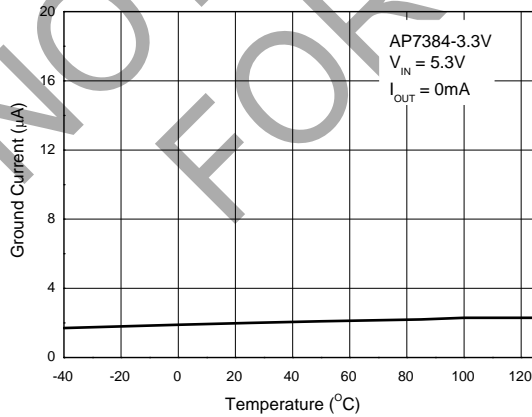

Load Transient

$C_{IN} = 1\mu\text{F}$, $C_{OUT} = 2.2\mu\text{F}$, $V_{IN} = V_{OUT} + 2\text{V}$, $I_{OUT} = 0$ to 50mA

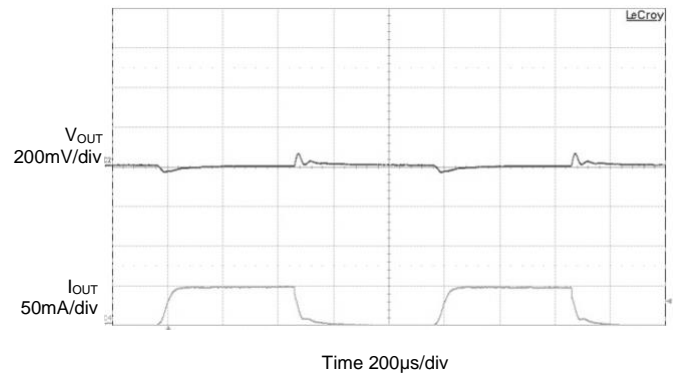

Ordering Information

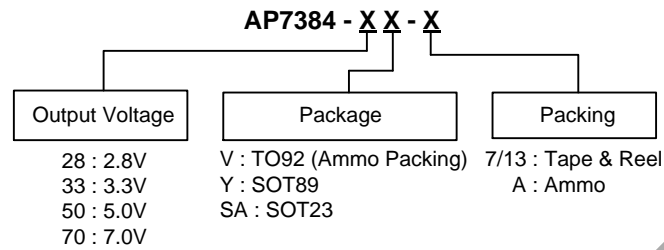

| Part Number | Package Code | Package | Packing | | Part Number Suffix |
|---------------|--------------|----------------------|----------|-------------|--------------------|
| | | | Quantity | Carrier | |
| AP7384-28V-A | V | TO92 (Ammo Packing) | 2000 | Ammo | -A |
| AP7384-33V-A | V | TO92 (Ammo Packing) | 2000 | Ammo | -A |
| AP7384-50V-A | V | TO92 (Ammo Packing) | 2000 | Ammo | -A |
| AP7384-70V-A | V | TO92 (Ammo Packing) | 2000 | Ammo | -A |
| AP7384-28Y-13 | Y | SOT89 | 2500 | Tape & Reel | -13 |
| AP7384-33Y-13 | Y | SOT89 | 2500 | Tape & Reel | -13 |
| AP7384-50Y-13 | Y | SOT89 | 2500 | Tape & Reel | -13 |
| AP7384-70Y-13 | Y | SOT89 | 2500 | Tape & Reel | -13 |
| AP7384-28SA-7 | SA | SOT23 | 3000 | Tape & Reel | -7 |
| AP7384-33SA-7 | SA | SOT23 | 3000 | Tape & Reel | -7 |
| AP7384-50SA-7 | SA | SOT23 | 3000 | Tape & Reel | -7 |
| AP7384-70SA-7 | SA | SOT23 | 3000 | Tape & Reel | -7 |

Marking Information

(1) SOT89

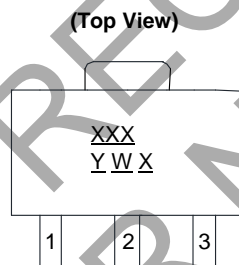

XXX : Identification Code
 Y : Year : 0 to 9
 W : Week : A to Z : 1 to 26 Week;
 a to z : 27 to 52 Week;
 z Represents 52 and 53 Week
 X : Internal Code

| Part Number | Package | Identification Code |
|---------------|---------|---------------------|
| AP7384-28Y-13 | SOT89 | F4A |
| AP7384-33Y-13 | SOT89 | F4B |
| AP7384-50Y-13 | SOT89 | F4C |
| AP7384-70Y-13 | SOT89 | F4D |

Marking Information (continued)

(2) TO92 (Ammo Packing)

(Top View)

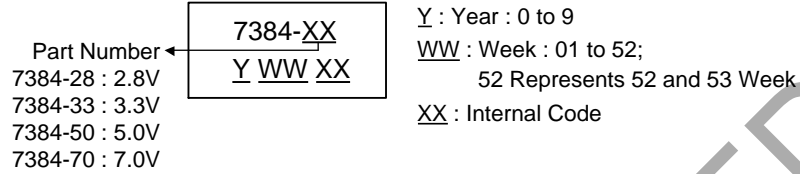

| Part Number | Package | Identification Code |
|--------------|---------------------|---------------------|
| AP7384-28V-A | TO92 (Ammo Packing) | 7384-28 |
| AP7384-33V-A | TO92 (Ammo Packing) | 7384-33 |
| AP7384-50V-A | TO92 (Ammo Packing) | 7384-50 |
| AP7384-70V-A | TO92 (Ammo Packing) | 7384-70 |

(3) SOT23

(Top View)

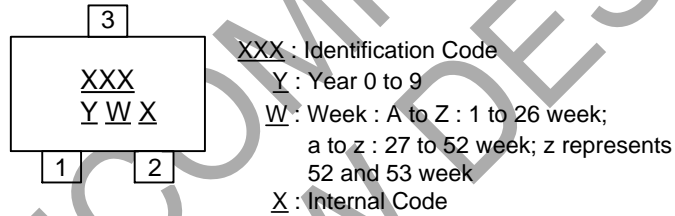

| Part Number | Package | Identification Code |
|---------------|---------|---------------------|
| AP7384-28SA-7 | SOT23 | F4A |
| AP7384-33SA-7 | SOT23 | F4B |
| AP7384-50SA-7 | SOT23 | F4C |
| AP7384-70SA-7 | SOT23 | F4D |

Package Outline Dimensions (All dimensions in mm.)

Please see <http://www.diodes.com/package-outlines.html> for the latest version.

(1) Package Type: SOT89

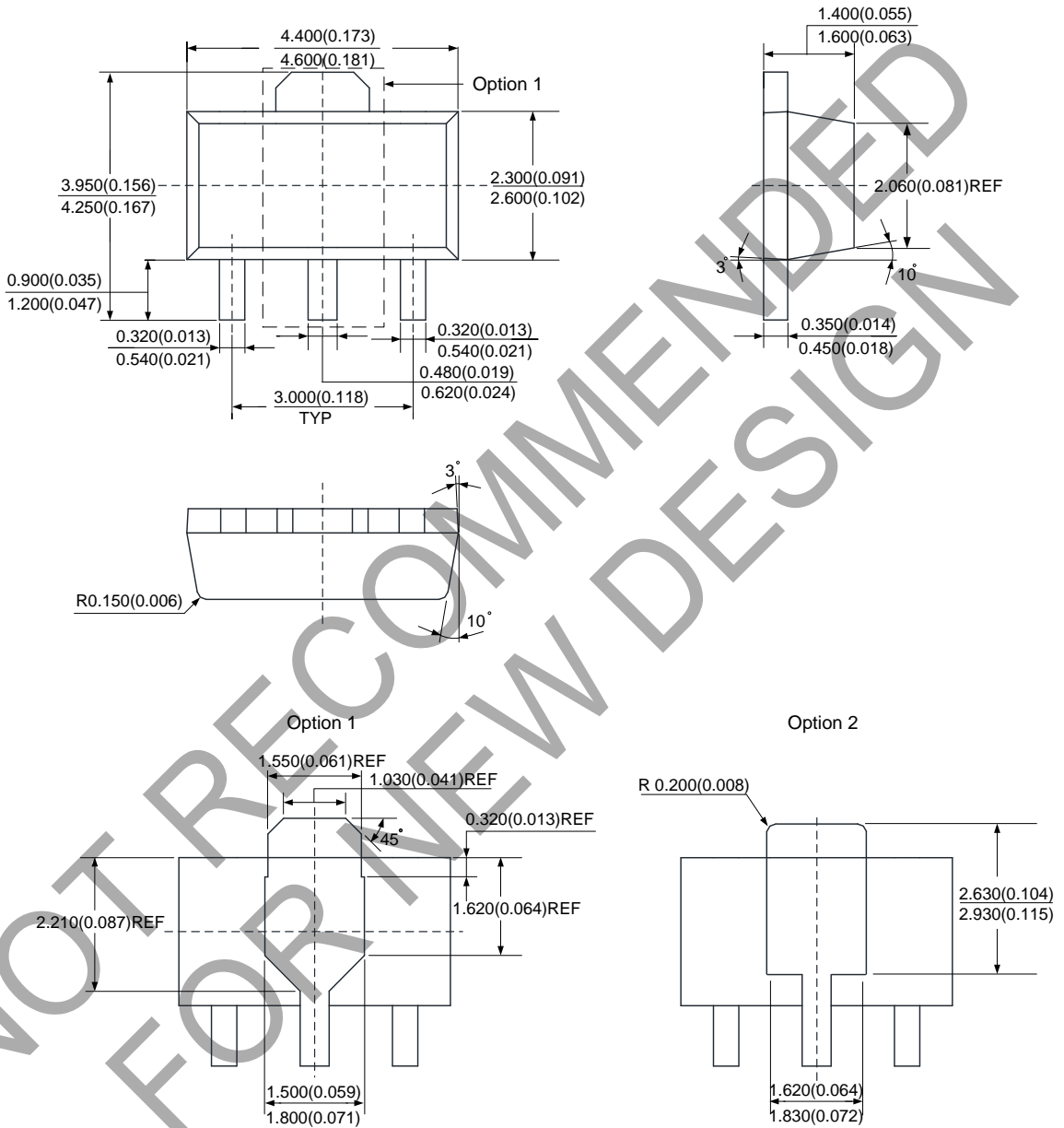

Package Outline Dimensions (continued. All dimensions in mm.)

Please see <http://www.diodes.com/package-outlines.html> for the latest version.

(2) TO92 (Ammo Packing)

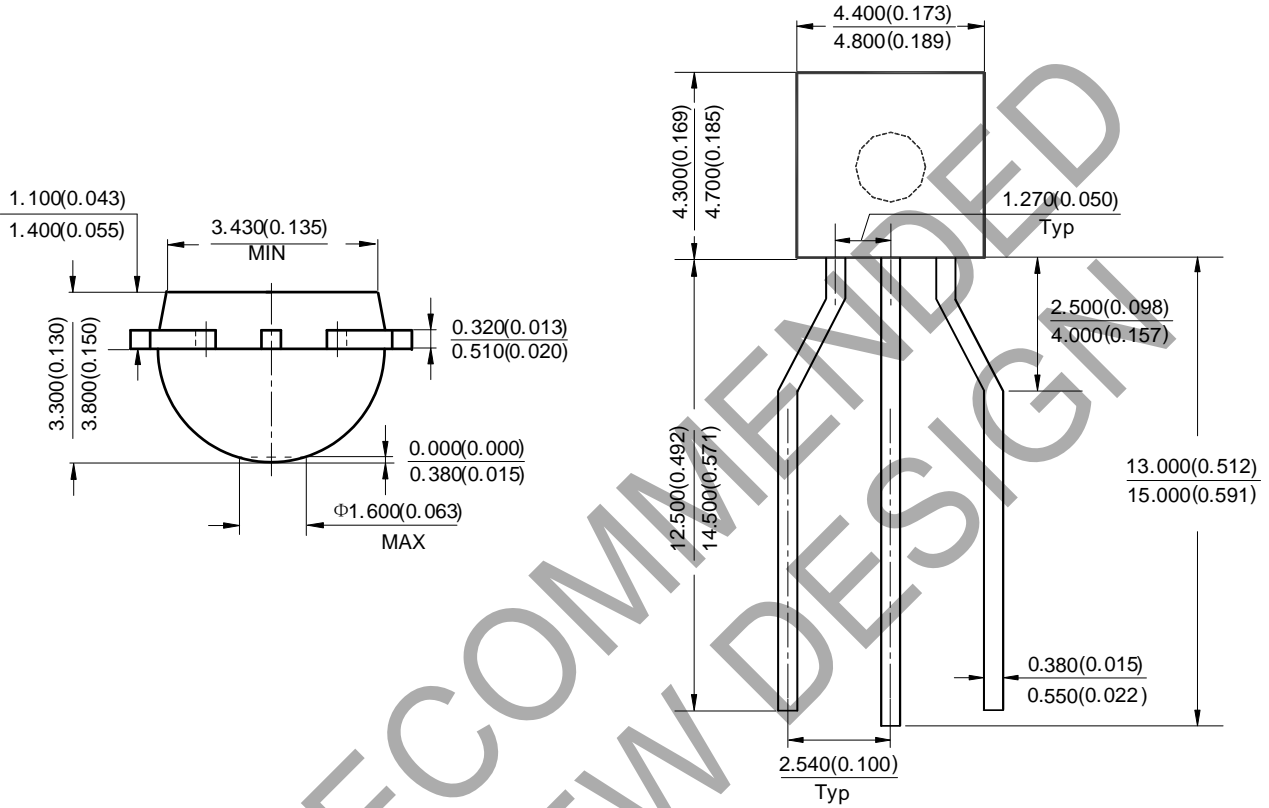

NOT RECOMMENDED FOR NEW DESIGN

Package Outline Dimensions (continued. All dimensions in mm.)

Please see <http://www.diodes.com/package-outlines.html> for the latest version.

(3) Package Type: SOT23

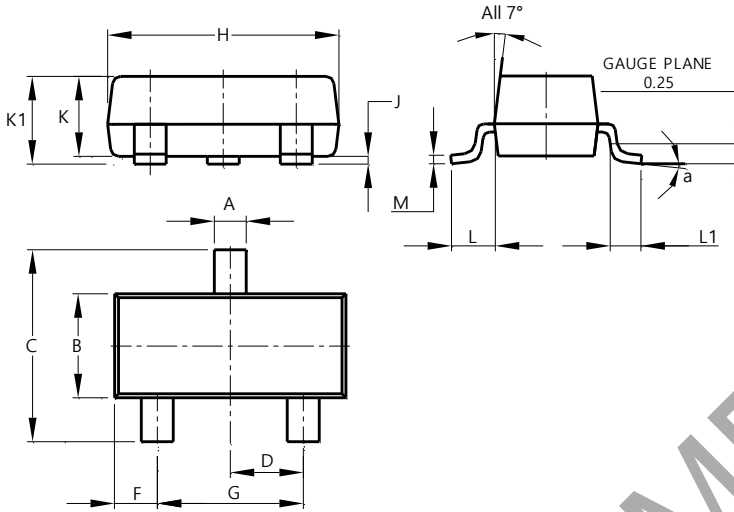

| SOT23 | | | |
|----------------------|-------|-------|-------|
| Dim | Min | Max | Typ |
| A | 0.37 | 0.51 | 0.40 |
| B | 1.20 | 1.40 | 1.30 |
| C | 2.30 | 2.50 | 2.40 |
| D | 0.89 | 1.03 | 0.915 |
| F | 0.45 | 0.60 | 0.535 |
| G | 1.78 | 2.05 | 1.83 |
| H | 2.80 | 3.00 | 2.90 |
| J | 0.013 | 0.10 | 0.05 |
| K | 0.890 | 1.00 | 0.975 |
| K1 | 0.903 | 1.10 | 1.025 |
| L | 0.45 | 0.61 | 0.55 |
| L1 | 0.25 | 0.55 | 0.40 |
| M | 0.085 | 0.150 | 0.110 |
| a | 0° | 8° | -- |
| All Dimensions in mm | | | |

NOT RECOMMENDED FOR NEW DESIGN

Suggested Pad Layout

Please see <http://www.diodes.com/package-outlines.html> for the latest version.

(1) Package Type: SOT89

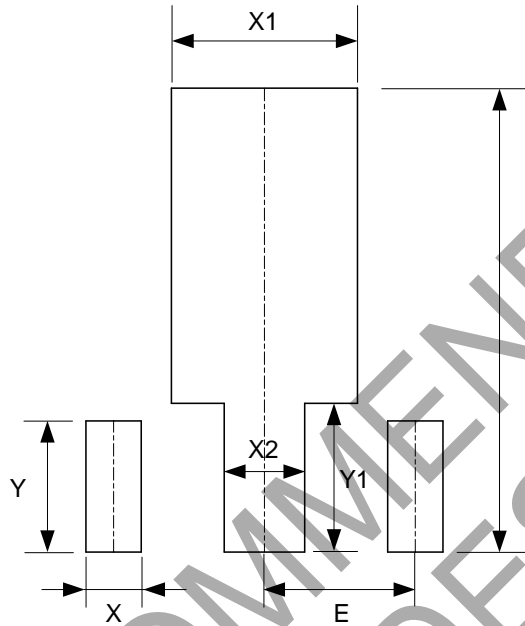

| Dimensions | Z (mm)/(inch) | X (mm)/(inch) | X1 (mm)/(inch) | X2 (mm)/(inch) | Y (mm)/(inch) | Y1 (mm)/(inch) | E (mm)/(inch) |
|------------|------------------|------------------|-------------------|-------------------|------------------|-------------------|------------------|
| Value | 4.600/0.181 | 0.550/0.022 | 1.850/0.073 | 0.800/0.031 | 1.300/0.051 | 1.475/0.058 | 1.500/0.059 |

(2) Package Type: SOT23

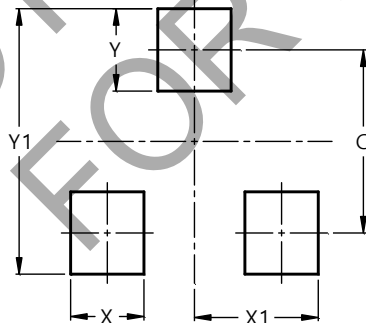

| Dimensions | Value (in mm) |
|------------|---------------|
| C | 2.0 |
| X | 0.8 |
| X1 | 1.35 |
| Y | 0.9 |
| Y1 | 2.9 |

IMPORTANT NOTICE

1. DIODES INCORPORATED (Diodes) AND ITS SUBSIDIARIES MAKE NO WARRANTY OF ANY KIND, EXPRESS OR IMPLIED, WITH REGARDS TO ANY INFORMATION CONTAINED IN THIS DOCUMENT, INCLUDING, BUT NOT LIMITED TO, THE IMPLIED WARRANTIES OF MERCHANTABILITY, FITNESS FOR A PARTICULAR PURPOSE OR NON-INFRINGEMENT OF THIRD PARTY INTELLECTUAL PROPERTY RIGHTS (AND THEIR EQUIVALENTS UNDER THE LAWS OF ANY JURISDICTION).
2. The Information contained herein is for informational purpose only and is provided only to illustrate the operation of Diodes' products described herein and application examples. Diodes does not assume any liability arising out of the application or use of this document or any product described herein. This document is intended for skilled and technically trained engineering customers and users who design with Diodes' products. Diodes' products may be used to facilitate safety-related applications; however, in all instances customers and users are responsible for (a) selecting the appropriate Diodes products for their applications, (b) evaluating the suitability of Diodes' products for their intended applications, (c) ensuring their applications, which incorporate Diodes' products, comply the applicable legal and regulatory requirements as well as safety and functional-safety related standards, and (d) ensuring they design with appropriate safeguards (including testing, validation, quality control techniques, redundancy, malfunction prevention, and appropriate treatment for aging degradation) to minimize the risks associated with their applications.
3. Diodes assumes no liability for any application-related information, support, assistance or feedback that may be provided by Diodes from time to time. Any customer or user of this document or products described herein will assume all risks and liabilities associated with such use, and will hold Diodes and all companies whose products are represented herein or on Diodes' websites, harmless against all damages and liabilities.
4. Products described herein may be covered by one or more United States, international or foreign patents and pending patent applications. Product names and markings noted herein may also be covered by one or more United States, international or foreign trademarks and trademark applications. Diodes does not convey any license under any of its intellectual property rights or the rights of any third parties (including third parties whose products and services may be described in this document or on Diodes' website) under this document.
5. Diodes' products are provided subject to Diodes' Standard Terms and Conditions of Sale (<https://www.diodes.com/about/company/terms-and-conditions/terms-and-conditions-of-sales/>) or other applicable terms. This document does not alter or expand the applicable warranties provided by Diodes. Diodes does not warrant or accept any liability whatsoever in respect of any products purchased through unauthorized sales channel.
6. Diodes' products and technology may not be used for or incorporated into any products or systems whose manufacture, use or sale is prohibited under any applicable laws and regulations. Should customers or users use Diodes' products in contravention of any applicable laws or regulations, or for any unintended or unauthorized application, customers and users will (a) be solely responsible for any damages, losses or penalties arising in connection therewith or as a result thereof, and (b) indemnify and hold Diodes and its representatives and agents harmless against any and all claims, damages, expenses, and attorney fees arising out of, directly or indirectly, any claim relating to any noncompliance with the applicable laws and regulations, as well as any unintended or unauthorized application.
7. While efforts have been made to ensure the information contained in this document is accurate, complete and current, it may contain technical inaccuracies, omissions and typographical errors. Diodes does not warrant that information contained in this document is error-free and Diodes is under no obligation to update or otherwise correct this information. Notwithstanding the foregoing, Diodes reserves the right to make modifications, enhancements, improvements, corrections or other changes without further notice to this document and any product described herein. This document is written in English but may be translated into multiple languages for reference. Only the English version of this document is the final and determinative format released by Diodes.
8. Any unauthorized copying, modification, distribution, transmission, display or other use of this document (or any portion hereof) is prohibited. Diodes assumes no responsibility for any losses incurred by the customers or users or any third parties arising from any such unauthorized use.
9. This Notice may be periodically updated with the most recent version available at <https://www.diodes.com/about/company/terms-and-conditions/important-notice>

The Diodes logo is a registered trademark of Diodes Incorporated in the United States and other countries.
DIODES is a trademark of Diodes Incorporated in the United States and other countries.
All other trademarks are the property of their respective owners.
© 2022 Diodes Incorporated. All Rights Reserved.

www.diodes.com

Looking for pricing, stock, or lifecycle information?

Click below to explore more details on WIN SOURCE:

- ⊖ [View AP7384-50SA-7 on WIN SOURCE](#)
- ⊖ [Diodes Incorporated Information](#)

Optimize Your Supply Chain with WIN SOURCE Solutions

- ✓ Global Sourcing Solution
- ✓ Obsolete Management
- ✓ Cost Control Management
- ✓ Shortage Management
- ✓ Alternative Solution
- ✓ Excess Inventory Management