



**THE DATASHEET OF
12600-S-10**



3M™ I/O Connector Mounting Options and Hardware

Hardware Guide

Date Modified: April 24, 2012

Mounting Hardware Applications - Table 1

| Part Number | Type | Mini D Ribbon (MDR) Conn.'s | D Sub Conn.'s | D Ribbon Conn.'s | Shrunk D Ribbon (SDR) Conn.'s | Sheet # | RIA Code |
|-------------------------|-------------------|-----------------------------|---------------|------------------|-------------------------------|---------|-------------------|
| 3341-1L ² | Jack Socket Screw | | X | X | | 2 of 9 | RIA E5 & C3 apply |
| 3341-1S ² | Jack Socket Screw | | X | X | | | |
| 3341-2 | Jack Socket Screw | | | X | | | |
| 3341-3 | Jack Socket Screw | | | X | | | |
| 3341-4 ² | Jack Socket Screw | | X | X | | | |
| 3341-10 | Jack Socket Screw | X | | | | 3 of 9 | |
| 3341-13 | Jack Socket Screw | X | | | | | |
| 3341-16 | Jack Socket Screw | X | | | | | |
| 3341-17 | Jack Socket Screw | X | | | | | |
| 3341-25 | Jack Socket Screw | X | | | | | |
| 3341-30 | Jack Socket Screw | X | | | | 4 of 9 | |
| 3341-31 | Jack Socket Screw | X | | | | | |
| 3341-32 | Jack Socket Screw | X | | | | | |
| 3341-35 | Jack Socket Screw | X | | | | | |
| 3341-36 | Jack Socket Screw | X | | | | | |
| 3342-1 ² | Jack Screw Kits | | X | | | 5 of 9 | |
| 3342-2 ² | Jack Screw Kits | | X | | | | |
| 3342-3 ² | Jack Screw Kits | | X | X | | | |
| 3342-4 ² | Jack Screw Kits | | X | X | | | |
| 3344-3 | Board Lock Screw | X | | | | 6 of 9 | |
| 3344-4 | Board Lock Screw | X | | | | | |
| 3344-26 | Panel Mount Screw | X | | | | | |
| 3344-38 | Panel Mount Screw | X | | | | | |
| 3344-44 | Panel Mount Screw | X | | | | | |
| 3344-45 | Panel Mount Screw | X | | | | 7 of 9 | |
| 3475-1 | Bail Mount Kits | | | X | | | |
| 3475-4 | Bail Mount Kits | | | X | | | |
| 3475-5 | Bail Mount Kits | | | X | | 8 of 9 | |
| 12600-S-08 | Jack Socket Screw | | | | X | | |
| 12600-S-10 | Jack Socket Screw | | | | X | | |
| 12600-S-12 | Jack Socket Screw | | | | X | | |
| 3344-46 | Board Lock Screw | | | | X | 9 of 9 | |
| Mounting hardware Guide | | | X | | | | |

-See sheet 7 of 9 for D Ribbon & Plastic Connector accessories.-

Notes:

1. Use Table 1 as a guide for selecting the correct mounting hardware.
2. See sheet 9 of 9 for selection guide - 9 to 37 and 50 position D Sub connectors.
3. See Regulatory Information Appendix (RIA) for chemical compliance information.

TS-0142-J
Sheet 1 of 9

3M™ I/O Connector Mounting Options and Hardware

Jack Socket Screws

3M Part Number 3341-1L

Kit Contents:
2 - Jack Sockets
4 - Spacers .031 [0.79] Thick
2 - Lock Washers
2 - 4-40 Nuts

Material: Steel
Finish: Zinc with Clear Chromate
Screw / Socket Thread Size: #4-40 / #4-40
Recommended Max. Torque: 7.0 inch-lbf [0.8 N-m]

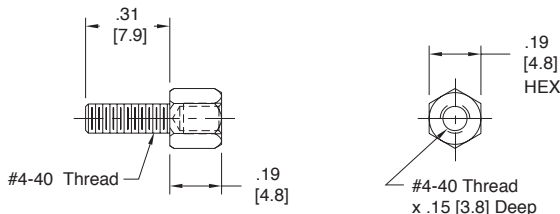

3M Part Number 3341-1S

Kit Contents:
2 - Jack Sockets
8 - Spacers .031 [0.79] Thick
2 - Lock Washers
2 - 4-40 Nuts

Material: Steel
Finish: Zinc with Clear Chromate
Screw / Socket Thread Size: #4-40 / #4-40
Recommended Max. Torque: 7.0 inch-lbf [0.8 N-m]

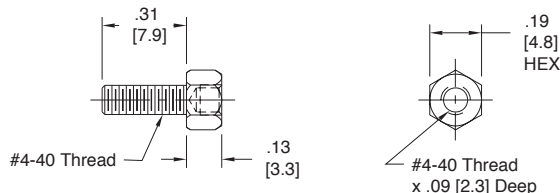

3M Part Number 3341-2

Kit Contents:
2 - Jack Sockets
2 - Lock Washers
2 - 4-40 Nuts

Material: Steel
Finish: Zinc with Clear Chromate
Screw / Socket Thread Size: #4-40 / #4-40
Recommended Max. Torque: 7.0 inch-lbf [0.8 N-m]

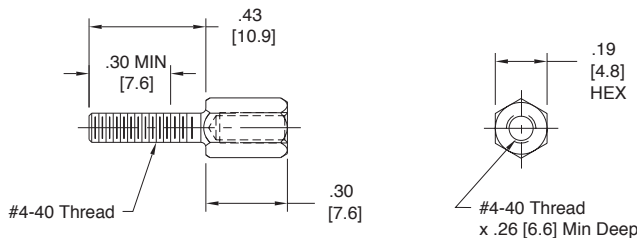

3M Part Number 3341-3 IEEE-488-Type

Kit Contents:
2 - Jack Sockets
4 - Spacers .031 [0.79] Thick
2 - Lock Washers
2 - 4-40 Nuts

Material: Steel
Finish: Black Oxide
Screw / Socket Thread Size: #4-40 / M3.5
Recommended Max. Torque: 7.0 inch-lbf [0.8 N-m]

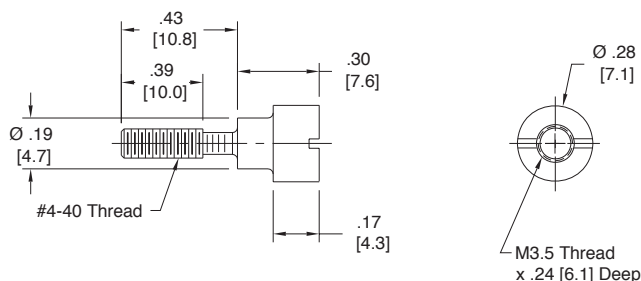

3M Part Number 3341-4

Kit Contents:
2 - Jack Sockets
4 - Spacers .031 [0.79] Thick
2 - Lock Washers
2 - 4-40 Nuts

Material: Steel
Finish: Zinc with Clear Chromate
Screw / Socket Thread Size: #4-40 / #4-40
Recommended Max. Torque: 7.0 inch-lbf [0.8 N-m]

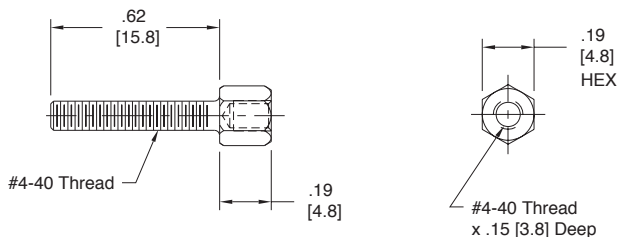

TS-0142-J
Sheet 2 of 9



3M™ I/O Connector Mounting Options and Hardware

3M Part Number 3341-10

Material: Stainless Steel
Screw / Socket Thread Size: M2.5 / M2.5
Recommended Max. Torque: 2.5 inch-lbf [0.3 N-m]

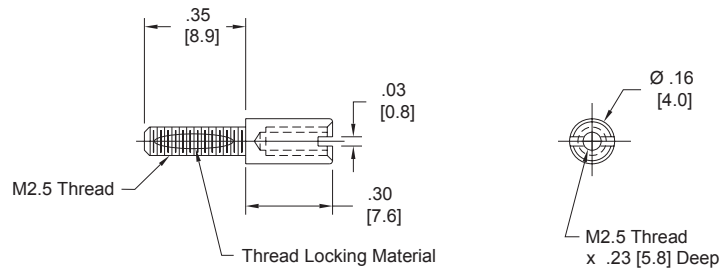

3M Part Number 3341-13

Material: Stainless Steel
Screw / Socket Thread Size: M2.5 / #4-40
Recommended Max. Torque: 2.5 inch-lbf [0.3 N-m]

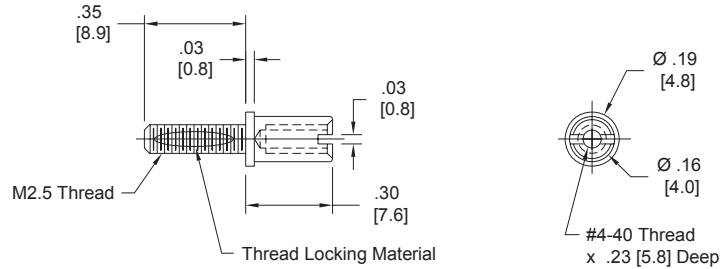

3M Part Number 3341-16

Material: Stainless Steel
Screw / Socket Thread Size: #4-40 / #4-40
Recommended Max. Torque: 3.5 inch-lbf [0.4 N-m]

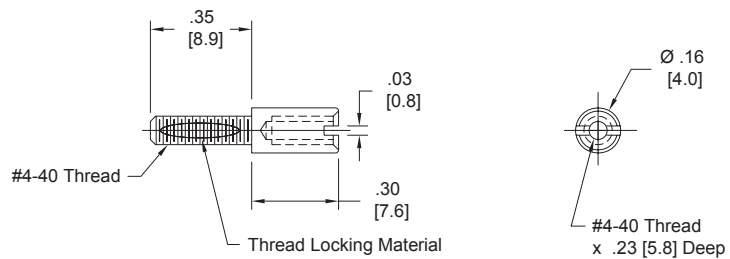

3M Part Number 3341-17

Material: Stainless Steel
Screw / Socket Thread Size: #4-40 / #4-40
Recommended Max. Torque: 3.5 inch-lbf [0.4 N-m]

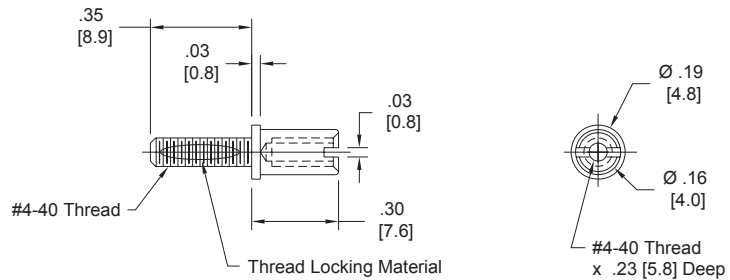

3M Part Number 3341-25

Material: Stainless Steel
Screw / Socket Thread Size: M2.5 / M2
Recommended Max. Torque: 2.5 inch-lbf [0.3 N-m]

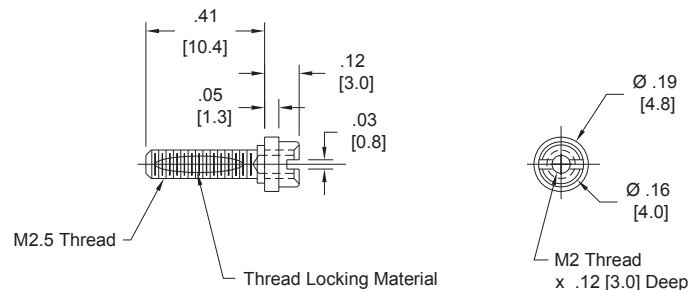

TS-0142-J
Sheet 3 of 9

3M™ I/O Connector Mounting Options and Hardware

3M Part Number 3341-30

Material: Stainless Steel
Screw / Socket Thread Size: #4-40 / #4-40
Recommended Max. Torque: 3.5 inch-lbf [0.4 N-m]

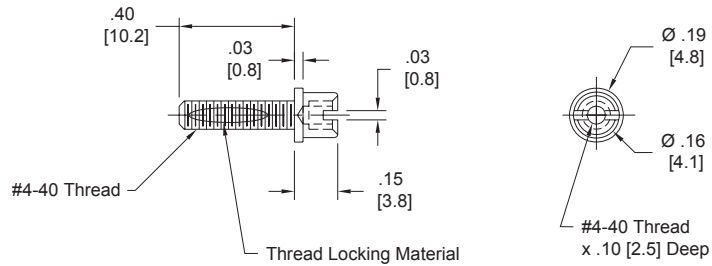

3M Part Number 3341-31

Material: Stainless Steel
Screw / Socket Thread Size: M2.5 / #4-40
Recommended Max. Torque: 2.5 inch-lbf [0.3 N-m]

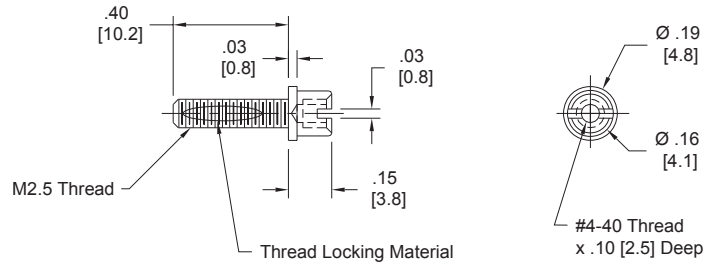

3M Part Number 3341-32

Material: Stainless Steel
Screw / Socket Thread Size: M2.5 / #4-40
Recommended Max. Torque: 2.5 inch-lbf [0.3 N-m]

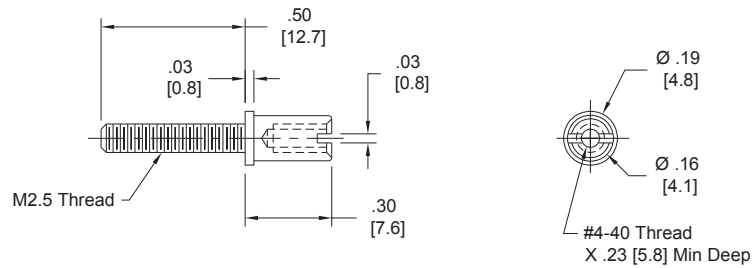

3M Part Number 3341-35

Material: Stainless Steel
Screw / Socket Thread Size: M2.5 / #4-40
Recommended Max. Torque: 2.5 inch-lbf [0.3 N-m]

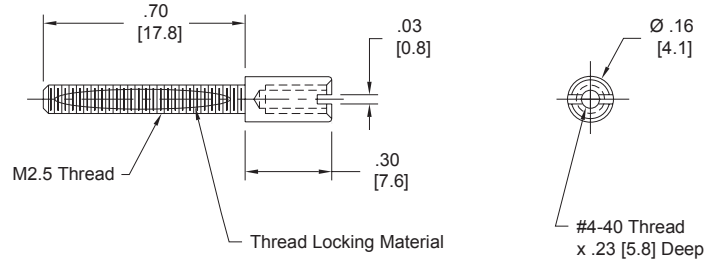

3M Part Number 3341-36

Material: Stainless Steel
Screw / Socket Thread Size: M2.5 / M2.5
Recommended Max. Torque: 2.5 inch-lbf [0.3 N-m]

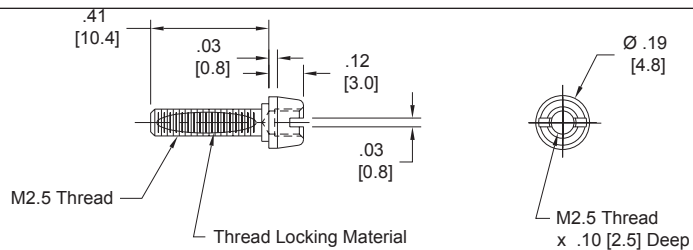

3M™ I/O Connector Mounting Options and Hardware

Jack Screw Kits

3M Part Number 3342-1

Kit Contents:
2 - Clips
2 - Jack Screws

Material: Steel
Finish: Zinc with Clear Chromate
Thread size: #4-40
Recommended Max. Torque: 7.0 inch-lbf [0.8 N-m]

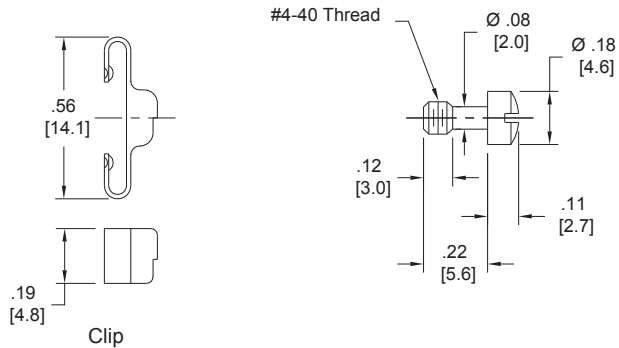

3M Part Number 3342-2

Kit Contents:
2 - Spacers
2 - Jack Screws

Material: Steel
Finish: Zinc with Clear Chromate
Thread size: #4-40
Recommended Max. Torque: 7.0 inch-lbf [0.8 N-m]

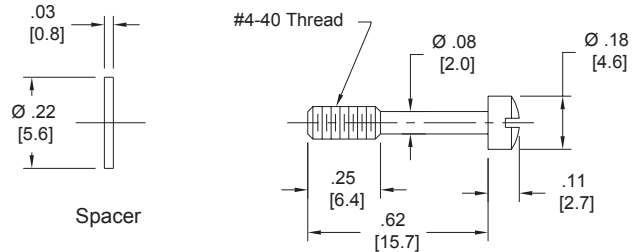

3M Part Number 3342-3

Kit Contents:
2 - Screws
2 - Jack Screws

Material: Steel
Finish: Zinc with Clear Chromate
Thread size: #4-40
Recommended Max. Torque: 7.0 inch-lbf [0.8 N-m]

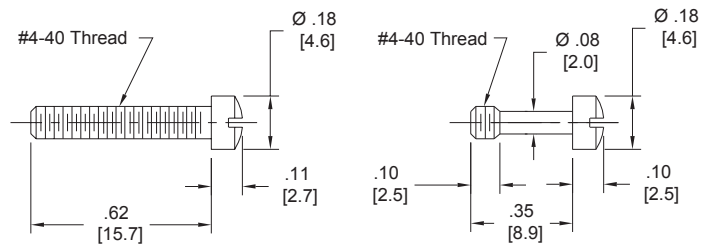

3M Part Number 3342-4

Material: Steel
Finish: Zinc with Clear Chromate
Thread size: #4-40
Recommended Max. Torque: 7.0 inch-lbf [0.8 N-m]

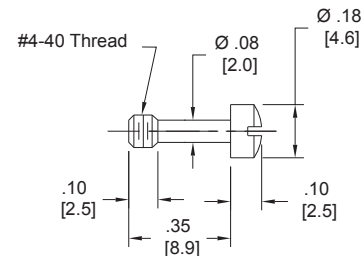

TS-0142-J
Sheet 5 of 9

3M™ I/O Connector Mounting Options and Hardware

Board Lock Screws

Use to attach connector to printed circuit board. Not for use for panel mounting.

3M Part Number 3344-3

Material: Steel
Finish: Nickel Plated
Thread size: M2.5
Recommended Max. Torque: 2.5 inch-lbf [0.3 N-m]

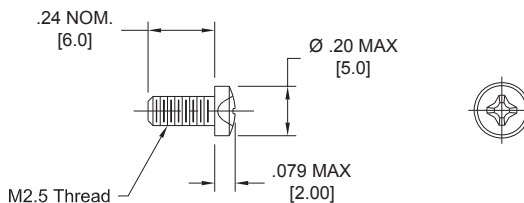

3M Part Number 3344-4

Material: Steel
Finish: Nickel Plated
Thread size: #4-40
Recommended Max. Torque: 3.5 inch-lbf [0.4 N-m]

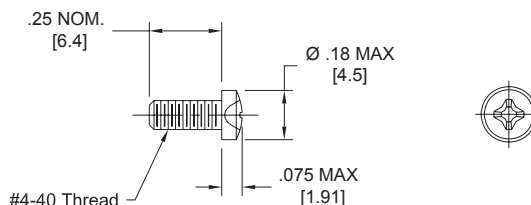

Panel Mount Screws

Use to attach connector to panel or chassis. Not for use for PCB mounting.

3M Part Number 3344-26

Material: Steel
Finish: Zinc
Thread size: M2.6
Recommended Max. Torque: 2.5 inch-lbf [0.3 N-m]

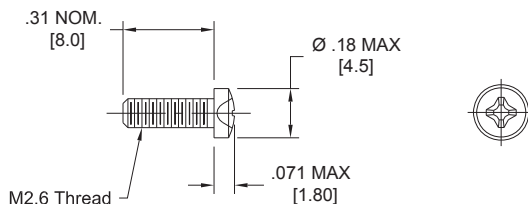

3M Part Number 3344-38

Material: Steel
Finish: Zinc
Thread size: M2.5
Recommended Max. Torque: 2.5 inch-lbf [0.3 N-m]

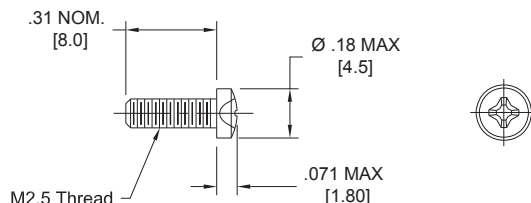

3M Part Number 3344-44

Material: Steel
Finish: Zinc
Thread size: #4-40
Recommended Max. Torque: 3.5 inch-lbf [0.4 N-m]

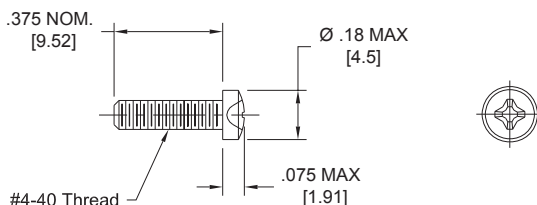

3M Part Number 3344-45

Material: Stainless Steel
Thread size: M2.5
Recommended Max. Torque: 2.5 inch-lbf [0.3 N-m]

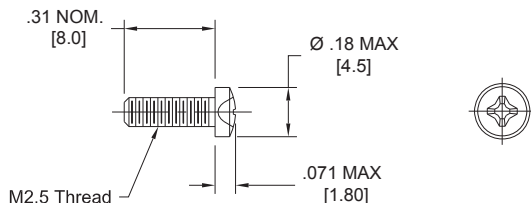

TS-0142-J
Sheet 6 of 9



3M™ I/O Connector Mounting Options and Hardware

Bail Mount Kits for D Ribbon Connectors

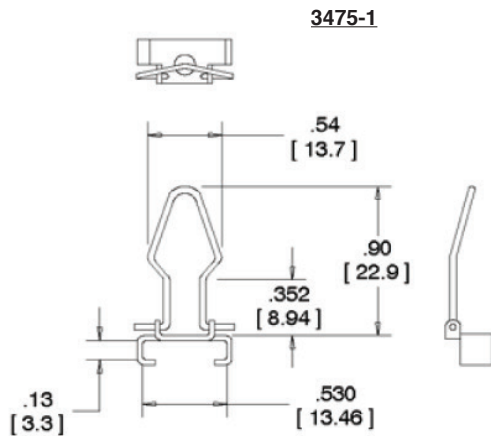

Plastic Connectors
Mounted to Front of Panel

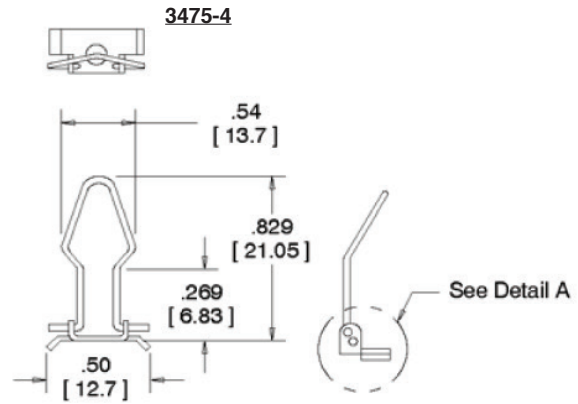

Plastic & Metal Faced Connectors
Mounted to Rear of
.0625, .075, .125 Panels

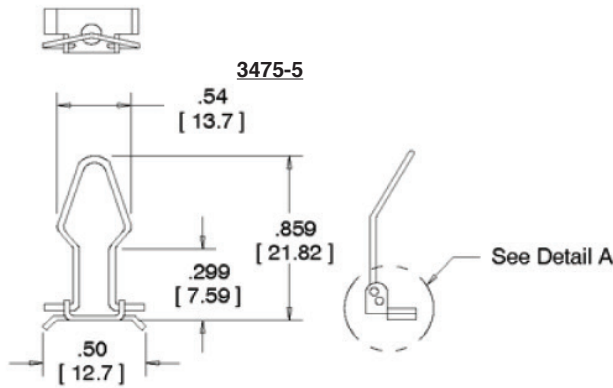

Plastic & Metal Faced Connectors
Mounted to Rear of
.035, .042, .094 Panels

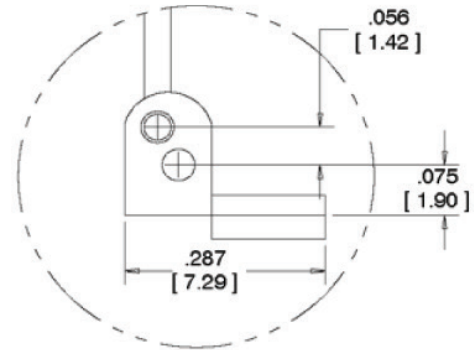

Detail A

Kits Contain 2 ea.
Bail Assy.
Screw - 4-40 x .50. RND HD SLTD
Nut - #4-40 UNC
Washer - Lock-split

| Material | |
|------------|--------------------|
| Bail Assy. | Steel, Zinc plated |
| Screw | Steel, Zinc plated |
| Nut | Steel, Zinc plated |
| Washer | Steel, Zinc plated |

D-Ribbon & Plastic Connectors

| Contact Quantity | Mating Connectors | | Junction Shell | Strain Relief | Pull-Tab |
|------------------|-------------------|-----------|----------------|---------------|----------|
| | Plug | Socket | Plastic | | |
| 14 | 3572-100X | 3573-100X | 3485-1800Y | 3448-60 | 3490-2 |
| 24 | 3548-100X | 3549-100X | 3485-1700Y | 3448-61 | 3490-2 |
| 36 | 3366-100X | 3367-100X | 3485-2800Y | 3448-62 | 3490-3 |
| 50 | 3564-100X | 3565-100X | 3485-2500Y | 3448-63 | 3490-5 |

Options:
X = mounting style
Y = "F" for flat cable, "R" for round cable

| Inch [mm] | | | |
|------------------------|------|-------|--------|
| Tolerance Unless Noted | | | |
| | .0 | .00 | .000 |
| Inch | ± .1 | ± .01 | ± .005 |

[] Dimensions for
Reference only

TS-0142-J
Sheet 7 of 9

3M™ I/O Connector Mounting Options and Hardware

Jack Socket Screws

Use to attach connector to panel or chassis. Not for use for PC board mounting.

3M Part Number 12600-S-08

For .03" [0.8 mm] Panel Thickness

Material: Steel
Finish: Nickel Plated
Screw / Socket Thread Size: M2 / M2
Recommended Max. Torque: 2.5 inch-lbf [0.3 N-m]

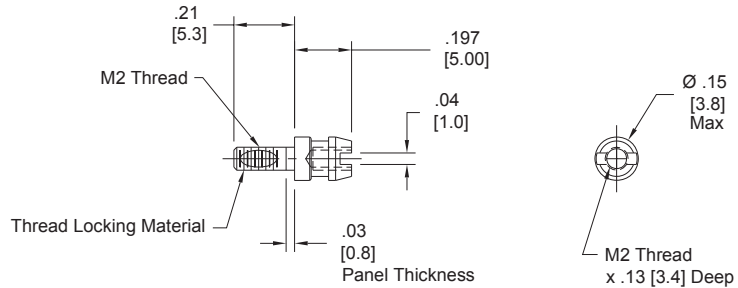

3M Part Number 12600-S-10

For .04" [1.0 mm] Panel Thickness

Material: Steel
Finish: Nickel Plated
Screw / Socket Thread Size: M2 / M2
Recommended Max. Torque: 2.5 inch-lbf [0.3 N-m]

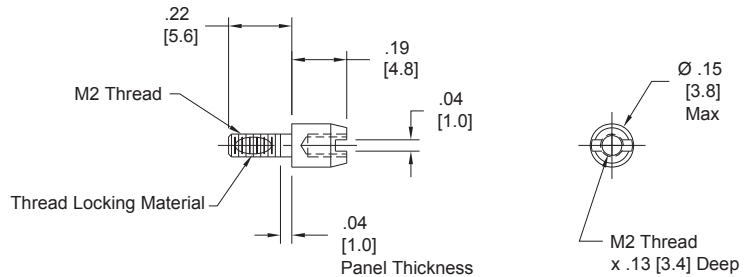

3M Part Number 12600-S-12

For .05" [1.2 mm] Panel Thickness

Material: Steel
Finish: Nickel Plated
Screw / Socket Thread Size: M2 / M2
Recommended Max. Torque: 2.5 inch-lbf [0.3 N-m]

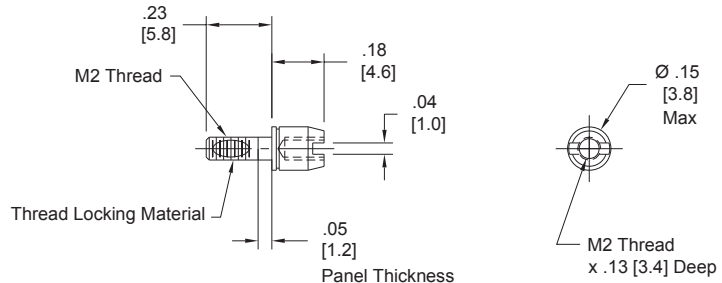

Board Lock Screw

Use to attach connector to printed circuit board. Not for use for panel mounting.

3M Part Number 3344-46

Material: Stainless Steel
Thread size: M2
Recommended Max. Torque: 2.5 inch-lbf [0.3 N-m]

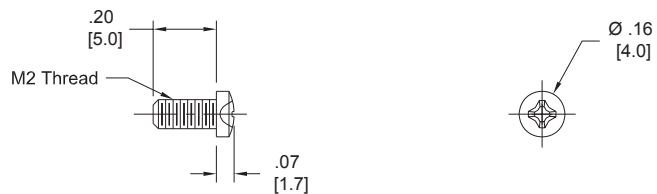

TS-0142-J
Sheet 8 of 9

3M™ I/O Connector Mounting Options and Hardware

D Sub Connectors

Mounting Hardware Guide

Selection Guide - 9 to 37 Position D Sub Connectors

1. To mount a connector to a panel, select the correct Jack Socket Kit from table 1.
2. To secure a mating connector to a panel mounted connector, select the correct Jack Screw Kit from table 2.
3. To secure two connectors together in a mid-span application where no panel exists, select both the Jack Socket Kit and Jack Screw Kit from table 2.

| Panel Mounted Connectors Jack Socket Kits | | | | |
|---|-------------|---------|------------|---------|
| Panel Thickness | Front Mount | | Rear Mount | |
| | Kit | Spacers | Kit | Spacers |
| 1/16 | 3341-1L | 2 | 3341-1L | 0 |
| 3/32 | 3341-1L | 2 | 3341-1S | 1 |
| 1/8 | 3341-4 | 2 | 3341-1S | 0 |

Note: Spacers Placed Under Head of Jack Sockets

| Junction Shell | Connectors with Junction Shells | | |
|----------------|---------------------------------|---------|-----------------|
| | Jack Screw Kit | Spacers | Jack Socket Kit |
| ----- | 3342-1 | ----- | 3341-1L |
| 3485-2X00 | 3342-2 | 2 | 3341-4 |
| 3357-41XX | 3342-2 | 2 | 3341-4 |
| 3357-51XX | 3342-2 | 2 | 3341-4 |
| 3357-65XX | 3342-x Supplied | ----- | 3341-4 |
| 3357-92XX | 3342-x Supplied or 3341-7 | | 3341-1L |

Notes:

1. Jack Sockets used for MidSpan Applications.
2. Spacers Placed Under Head of Jack Screws.

Selection Guide - 50 Position D Sub Connectors See TS-0034 Socket and TS-0035 Plug.

Mounting Options Using 3357-9250 Junction Shell & 3505-62 Latch Bracket. See TS-0245.

Front Panel Mounted Connectors:

Connectors not designed for this application

Rear Panel Mounted Connectors:

1/16" Panel: 1 Spacer Latch Bracket and Panel

3/32" Panel: No Spacers.

>3/32" Panel: Latch Bracket not designed for these applications.

Mid-Span Applications: Mount Latch Bracket directly to either the Plug or Socket Connector.

TS-0142-J
Sheet 9 of 9



Important Notice

All statements, technical information, and recommendations related to 3M's products are based on information believed to be reliable, but the accuracy or completeness is not guaranteed. Before using this product, you must evaluate it and determine if it is suitable for your intended application. You assume all risks and liability associated with such use. Any statements related to the product which are not contained in 3M's current publications, or any contrary statements contained on your purchase order shall have no force or effect unless expressly agreed upon, in writing, by an authorized officer of 3M.

Warranty; Limited Remedy; Limited Liability.

This product will be free from defects in material and manufacture for a period of one (1) year from the time of purchase. **3M MAKES NO OTHER WARRANTIES INCLUDING, BUT NOT LIMITED TO, ANY IMPLIED WARRANTY OF MERCHANTABILITY OR FITNESS FOR A PARTICULAR PURPOSE.** If this product is defective within the warranty period stated above, your exclusive remedy shall be, at 3M's option, to replace or repair the 3M product or refund the purchase price of the 3M product. **Except where prohibited by law, 3M will not be liable for any indirect, special, incidental or consequential loss or damage arising from this 3M product, regardless of the legal theory asserted.**

**3M Electronics Solutions Division**

6801 River Place Blvd.
Austin, TX 78726-9000
U.S.A.
1-800-225-5373
www.3Mconnectors.com

Please recycle. Printed in USA.
© 3M 2012. All rights reserved.
RIA-2217B-E

3M is a trademark of 3M Company.

Looking for pricing, stock, or lifecycle information?

Click below to explore more details on WIN SOURCE:

 [View 12600-S-10 on WIN SOURCE](#)

 [3M Information](#)

Optimize Your Supply Chain with WIN SOURCE Solutions

-  Global Sourcing Solution
-  Obsolete Management
-  Cost Control Management
-  Shortage Management
-  Alternative Solution
-  Excess Inventory Management