



**THE DATASHEET OF
10104320-009RLF**



Universal Contact

STAMPED AND FORMED, PRE-LOADED, SINGLE-PIECE SMT CONTACT

Amphenol's Basics universal contact is a single-piece SMT contact that provides an electrical connection between a device and a PCB with no higher than 2A current rating. The universal contact is stamped and formed terminal, incorporating pre-load and anti-lift features available in free height ranging from 1.2mm to 4.1mm, and the deflection range is from 0.6mm to 1.8mm. The universal contact is designed to connect the devices such as the battery, antenna, microphone, and speaker with PCB, and can also be used for grounding connection. It can accept the devices in multi directions, either horizontal or perpendicular.

- Solder-well design prevents the solder paste wicking up the contact
- Sidewall design protects the spring contact not being overstressing or yielding
- Domed contact point allows easier mating and lower contact resistance
- Wide range on working height provides design flexibility
- X-Y-Z 3 direction movement provides robust connection during shock and vibration



TARGET MARKETS



FEATURES

- Solderwell
- Side wall
- Domed contact point
- Wide range on working height
- X-Y-Z 3 direction movement
- RoHS compliant and lead-free

BENEFITS

- Prevents the solder paste wicking up the contact
- Protects the spring contact not being overstressing or yielding
- Allows easily mating and lower contact resistance
- Provides design flexibility
- Provides robust connection during shock and vibration
- Meets environmental, health and safety requirements

TECHNICAL INFORMATION

MATERIAL

- Base Material: Beryllium Copper or Titanium Copper or Stainless steel
- Contact Area Plating: Nickel under plating, selective Gold plating (or GXT®) in contact area, 0.05µm ~ 0.1µm
- Solder Area Plating: Gold flash or Tin over Nickel plating

ELECTRICAL PERFORMANCE

- Current Rating: 2.0A continuous, excluding 10123973-00*RLF which is 1A
- Voltage Rating: 12V max.
- LLCR: 20mΩ max.

ENVIRONMENTAL

- Operating Temperature Range: -40°C to +85°C

SPECIFICATIONS

- Product Specification: GS-12-500

MECHANICAL PERFORMANCE

- Durability: 100 cycles

PACKAGING

- Tape and Reel

TARGET MARKETS/APPLICATIONS



key Fob



Phone
Smart Devices
Gaming Box
Portable HDD
Laptop
Desktop



Handheld Devices



Scanning Equipment

PART NUMBERS

Part Number	A	B	C	C1	D	E	F	G (pick and place nozzle location)	Working Height
10076430-00*RLF	1.80±0.10	3.40±0.13	0.90±0.10	1.10±0.10	1.00±0.10	0.84±0.20	0.47 min	2.7 Ref.	1.10±0.10
10094594-00*RLF	1.30±0.10	3.48±0.10	1.40±0.10	1.50±0.10	0.77±0.10	0.80±0.20	0.30 min	2.5 Ref.	1.00±0.10
10103955-00*RLF	1.80±0.10	3.40±0.13	0.90±0.10	1.10±0.10	0.95±0.10	0.84±0.20	0.47 min	2.7 Ref.	1.10±0.10
10104319-00*RLF	2.50±0.10	4.87±0.15	0.98±0.10	1.28±0.10	1.40±0.10	1.19±0.20	0.74 min	2.8 Ref.	1.55±0.10
10104320-00*RLF	1.30±0.10	3.48±0.10	1.10±0.10	1.30±0.10	0.72±0.10	0.80±0.20	0.30 min	2.5 Ref.	1.00±0.10
10104321-00*RLF	3.50±0.10	5.00±0.13	1.10±0.10	1.40±0.10	2.00±0.10	1.65±0.20	0.50 min	3.4 Ref.	2.20±0.10
10115748-00*RLF	1.55±0.10	3.48±0.10	1.40±0.10	1.50±0.10	0.87±0.10	0.80±0.20	0.30 min	2.5 Ref.	1.02±0.10
10123973-00*RLF	1.2+0.15/-0	2.60±0.10	1.10±0.10	/	0.40±0.05	0.32±0.10	0.15 min	1.75 Ref.	0.50±0.05
10125000-00*RLF	2.10±0.10	3.40±0.13	1.10±0.10	1.20±0.13	1.20±0.10	0.90±0.20	0.30 min	2.2 Ref.	1.60±0.05
10128200-00*RLF	2.10±0.10	3.40±0.13	1.10±0.10	1.20±0.13	1.25±0.10	0.90±0.20	0.30 min	2.2 Ref.	1.60±0.05
10128875-00*RLF	4.10±0.10	5.00±0.13	1.10±0.10	1.40±0.10	2.30±0.10	1.65±0.20	0.40 min	3.4 Ref.	2.50±0.10

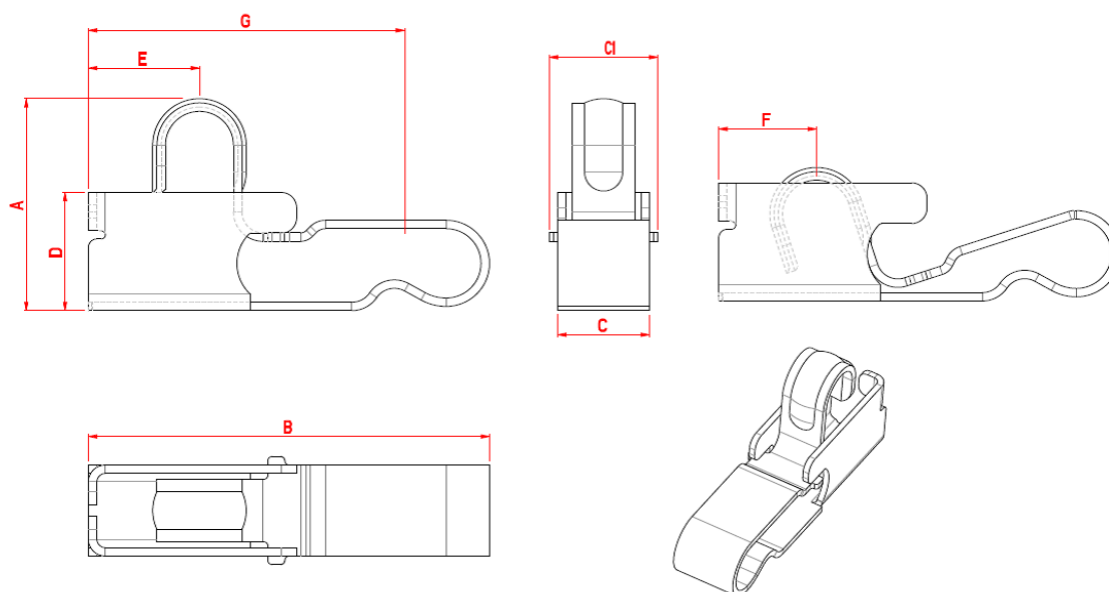

Looking for pricing, stock, or lifecycle information?

Click below to explore more details on WIN SOURCE:

-  [View 10104320-009RLF on WIN SOURCE](#)
-  [Amphenol Information](#)

Optimize Your Supply Chain with WIN SOURCE Solutions

-  Global Sourcing Solution
-  Obsolete Management
-  Cost Control Management
-  Shortage Management
-  Alternative Solution
-  Excess Inventory Management