

### FEATURES

- UL60950 recognised for reinforced insulation
- ANSI/AAMI ES60601-1, 1 MOPP/2 MOOPs recognised<sup>4</sup>
- 3kVAC isolation test voltage 'Hi Pot Test'
- Continuous short circuit protection
- Output voltage trim
- Remote on/off pin
- No electrolytic capacitors
- Operation up to 105°C (with derating)
- 2:1 input range

### PRODUCT OVERVIEW

The MTC2 series of miniature surface mount DC-DC converters offers a single output voltage from input voltage ranges of 4.5-9V, 9-18V and 18-36V. The MTC2 series regulated output voltage is adjustable by  $\pm 10\%$  and a remote on/off pin is also included for application power saving.

The MTC2 ideally suited to applications which include medical, industrial, telecommunications, battery powered systems, and process automation.

### SELECTION GUIDE

Order Code <sup>1</sup>	Input Voltage	Output Voltage	Output Current	Rated Input Current	Efficiency		Ripple and Noise		MTTF <sup>2</sup>	
					Min.	Typ.	Typ.	Max.	MIL.	Tel.
					%	%	mVp/p	mVp/p	kHrs	kHrs
MTC2S0503MC <sup>3</sup>	5	3.3	606	550	70	73	75	120	1270	2371
MTC2S0505MC <sup>3</sup>	5	5	400	530	71	76	90	120	1287	2670
MTC2S0512MC <sup>3</sup>	5	12	167	510	74	78.5	75	120	1170	2106
MTC2S1203MC	12	3.3	606	210	76	78.5	40	50	1085	2704
MTC2S1205MC	12	5	400	210	77	80	45	60	1067	3260
MTC2S1212MC	12	12	167	200	81	83.5	45	60	1067	3004
MTC2S2403MC	24	3.3	606	110	75	78.5	55	75	946	2540
MTC2S2405MC	24	5	400	100	76	79.5	35	55	854	2275
MTC2S2412MC	24	12	167	100	78	81.5	50	70	964	2424

### INPUT CHARACTERISTICS

Parameter	Conditions	Min.	Typ.	Max.	Units
Voltage range	5V input types	4.5	5	9	V
	12V input types	9	12	18	
	24V input types	18	24	36	
Input reflected ripple current	5V input types		20		mA p-p
	All other variants		4		

### ISOLATION CHARACTERISTICS

Parameter	Conditions	Min.	Typ.	Max.	Units
Isolation test voltage	Production tested for 1 second	3000			VAC
	Qualification tested for 1 minute	3000			
Isolation capacitance	All variants		20		pF
Resistance	Viso = 1kVDC	1			GΩ
Safety Standard	UL60950-1 Reinforced			250	VAC
	ANSI/AAMI ES60601-1 1 MOPP/2 MOOP			250	

### OUTPUT CHARACTERISTICS

Parameter	Conditions	Min.	Typ.	Max.	Units
Rated power	All output types			2	W
Minimal load to meet datasheet specification		10			%
Voltage set point accuracy	5V input types	-2.5		2	%
	All other input types			$\pm 2$	
Line regulation	Low line to high line	0503, 0505 & 0512		$\pm 0.05$	$\pm 0.2$
		All other variants			$\pm 0.5$
Load regulation	All output types	0503		$\pm 0.1$	$\pm 0.2$
		0505 & 0512		$\pm 0.05$	$\pm 0.2$
		All other variants			$\pm 0.5$



For full details go to <https://www.murata.com/en-global/products/power/rohs>



1. Components are supplied in tape and reel packaging, please refer to package specification section. Orderable part numbers are MTC2SXXXXMC-R7 (30 pieces per reel), or MTC2SXXXXMC-R13 (150 pieces per reel)
2. Calculated using MIL-HDBK-217 FN2 and Telcordia SR-332 calculation model with nominal input voltage at full load.
3. MTC2S05xxMC variants are currently pending recognition to UL62368-1 as UL60950 is superseded by UL62368.
4. ANSI/AAMI ES60601-1 recognition is currently pending for MTC2S05xxMC.

All specifications typical at  $T_A=25^\circ\text{C}$ , nominal input voltage and rated output current unless otherwise specified.

OUTPUT CHARACTERISTICS (Continued)						
Parameter	Conditions	Min.	Typ.	Max.	Units	
Transient response	Peak deviation (25-75% & 75-25% swing)	3.3V output types			±8	%V <sub>out</sub>
		12V output types			±2	
		0503			±4	
		0505			±4.5	
		0512			±1.5	
		1205			±6	
		2405			±5	
	Settling time (1% V <sub>out</sub> Nom.)	0503		420		μs
		0505		1000		
		0512		180		
		1203		45		
		1205		80		
		1212		60		
		2403		55		
		2405		75		
2412		100				

GENERAL CHARACTERISTICS						
Parameter	Conditions	Min.	Typ.	Max.	Units	
Switching frequency	0503		135		kHz	
	0505		115			
	0512		140			
	1203		285			
	1205, 1212		260			
	2403		185			
	2405		225			
	2412		240			
Remote on/off pin	Module on, pin unconnected or open collector floating					
	Module off (refer to application notes)	3.3V output types		3		V
		5V & 12V output types		2		
	5V input types		0.25		mW	
	1203, 1205		1.4			
	1212		1.5			
	2403, 2405		3.9			
2412		4.2				

TEMPERATURE CHARACTERISTICS						
Parameter	Conditions	Min.	Typ.	Max.	Units	
Operation	All output types (see derating curves)	-40		105	°C	
Storage		-50		125		
Case temperature above ambient	100% Load, Nom V <sub>in</sub> , Still Air		22			

ABSOLUTE MAXIMUM RATINGS	
Short-circuit protection (for SELV input voltages)	Continuous
Remote on/off pin input voltage <sup>1</sup>	12V
Input voltage, MTC2 5V input types	15V
Input voltage, MTC2 12V input types	25V
Input voltage, MTC2 24V input types	40V

1. Provided that external control circuit is the same as application note on page 5.



### ENVIRONMENTAL VALIDATION TESTING

The following tests have been conducted on this product series, please contact Murata if further information about the tests is required.

Test	Standard	Condition
Temperature cycling	MIL-STD-883 1010, Condition B	10 cycles between two chambers set to achieve -55°C and +125°C. The dwell time shall not be less than 10min and the load shall reach the specified temperature in 15min.
HAST (biased)	JEDEC JESD22-A110	96Hrs +2/-0Hrs at 130°C ± 2°C, 85% ± 5% R.H.
High temperature storage life	JEDEC JESD22-A103, Condition A	125°C +10/-0°C for ≥1000 hours
Vibration	BS EN 61373 with respect to BS EN 60068-2-64, Test Fh Category 1 Class B	5 – 150Hz. Level at each axis – Vertical, Traverse and Longitudinal: 5.72m/s <sup>2</sup> rms. 5 hours in each axis. Crest factor: 3 Sigma. Device is secured via pins.
Shock	BS EN 61373: Category 1 Class B	Test is 30ms duration, 3 shocks in each sense of 3 mutually perpendicular axes (18 shocks total). Level at each axis as follows: Vertical, Traverse and Longitudinal: 50m/s <sup>2</sup> . Device is secured via pins.
Solderability	IPC/ECA J-STD-002, Test A and A1	SnPb (Test A): For lead free solderability, 5 off Parts conditioned to a 48hour dry bake at 125°C followed by 4 hours at 155°C and 5 off Parts conditioned to 96hours at 125°C. All 10 Dipped in solder at 245°C ±5°C for 5 +0/-0.5 seconds. Pb-free (Test A1): For leaded solderability, 5 off Parts conditioned to a 48hour dry bake at 125°C followed by 4 hours at 155°C and 5 off Parts conditioned to 96hours at 125°C. All 10 Dipped in solder at 255°C ±5°C for 5 +0/-0.5 seconds.
Solvent cleaning	Resistance to cleaning agents	Solvent – Novec 71IPA & Topklean EL-20A. Pulsed ultrasonic immersion 45°C- 65°C
Solvent resistance	MIL-STD-883, Method 2015	The parts and the bristle portion of the brush are immersed in Isopropanol for a minimum of 1 minute. The parts are brushed 3 times, after the third time the parts are blown dry and inspected.

**CHARACTERISATION TEST METHODS**

**Ripple & Noise Characterisation Method**

Ripple and noise measurements are performed with the following test configuration.

C1	1µF X7R multilayer ceramic capacitor, voltage rating to be a minimum of 3 times the output voltage of the DC-DC converter
C2	10µF tantalum capacitor, voltage rating to be a minimum of 1.5 times the output voltage of the DC-DC converter with an ESR of less than 100mΩ at 100 kHz
C3	100nF multilayer ceramic capacitor, general purpose
R1	450Ω resistor, carbon film, ±1% tolerance
R2	50Ω BNC termination
T1	3T of the coax cable through a ferrite toroid
RLOAD	Resistive load to the maximum power rating of the DC-DC converter. Connections should be made via twisted wires

Measured values are multiplied by 10 to obtain the specified values.

**Differential Mode Noise Test Schematic**

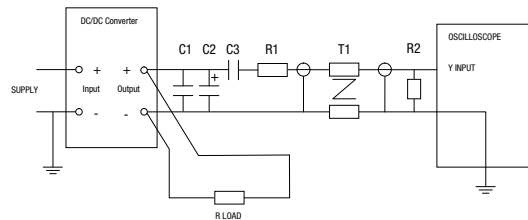

**APPLICATION NOTES**

**Maximum Output Capacitance**

Maximum output capacitance should not exceed:

Output Voltage V	Maximum Load Capacitance µF
3.3	470
5	470
12	220

**Start-up times**

Typical start up times for this series, with a typical input voltage rise time of 2.2µs and output capacitance of 10µF (5V inputs), 470µF (3.3, 5V outputs) and 220µF (12V outputs), are shown in the table below. The product series will start into the maximum output capacitance with increased start times.

Part No.	Start-up times
	ms
MTC2S0503MC	12
MTC2S0505MC	20
MTC2S0512MC	37
MTC2S1203MC	3
MTC2S1205MC	10.5
MTC2S1212MC	31
MTC2S2403MC	7
MTC2S2405MC	12
MTC2S2412MC	21

Typical Wave Form:

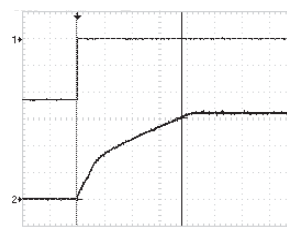

**APPLICATION NOTES (Continued)**

**Control Pin**

The MTC2 converters have a shutdown feature which enables the user to disable the converter into a low power state. The control pin connects to the base of an internal NPN transistor with the converter shut down when the transistor is turned on by an external applied voltage. The converter can also be shut down using a 5V TTL signal (the unit is OFF for logic High and ON for logic LOW). If the control pin is left open (high impedance), the converter will run normally. A suitable application circuit is shown below.

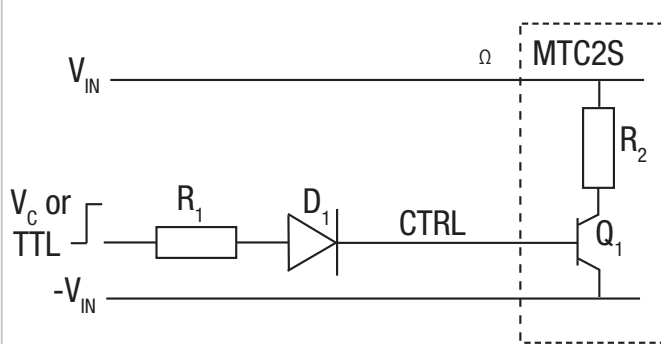

$D_1$  (e.g. 1N4001) is necessary for correct operation of the MTC2 when the control signal is LOW. The recommended drive current  $I_B$  to shut down the MTC2 is 6mA to 15mA. The value of  $R_1$  can be derived as follows:

$$R_1 = \frac{V_C - V_{D1} - 0.6}{I_B}$$

For a switch input:  
Calculate the value of  $R_1$  from the above equation given switch voltage  $V_C$  and chosen current between 6 and 15mA.

For 5V TTL Signal:  
Set  $R_1$  to be between 320Ω to 800Ω.

**Output Voltage Adjustment**

The MTC2 series has a trim capability which is located at pin 3, this allows the user to independently adjust the output voltages by  $\pm 10\%$ . Adjustments to the output voltages can be accomplished via a single fixed resistor as shown in Figures 1 and 2. A single fixed resistor can increase or decrease the output voltage depending on its connection. Fixed resistors should have low temperature coefficient to minimize sensitivity to changes in temperature.

A single resistor connected from the TRIM pin (pin 3) to the +Vout (pin 4), will decrease the output voltage which is shown in figure 1.

A single resistor connected from the TRIM pin (pin 3) to the -Vout (pin 2) will increase the output voltage which is shown in figure 2.

**TRIM DOWN**

Figure 1. Trim connections to decrease the output voltage

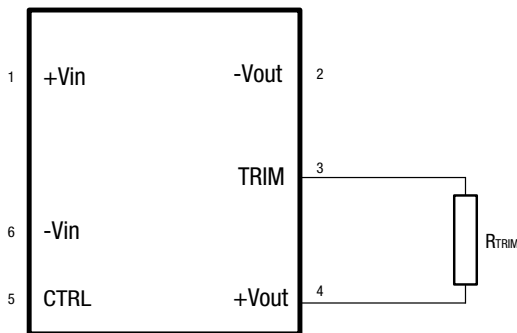

$$3.3V_{out} R_{TRIM} = \frac{18.64k \times V_{out} - 52.3k}{3.32 - V_{out}} \quad 5V_{in} 12V_{out} R_{TRIM} = \frac{30.4k \times V_{out} - 194.723k}{12.0744 - V_{out}}$$

$$5V_{out} R_{TRIM} = \frac{33.2k \times V_{out} - 141k}{5 - V_{out}}$$

$$12V_{out} R_{TRIM} = \frac{24.4k \times V_{out} - 181.388k}{12.2087 - V_{out}}$$

**TRIM UP**

Figure 2. Trim connections to increase the output voltage

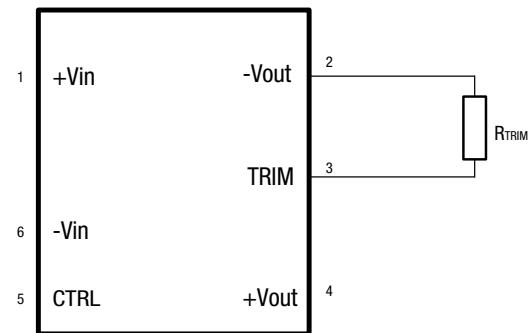

$$3.3V_{out} R_{TRIM} = \frac{14k \times V_{out} - 52.3k}{3.32 - V_{out}} \quad 5V_{in} 12V_{out} R_{TRIM} = \frac{12.4k \times V_{out} - 194.723k}{12.0744 - V_{out}}$$

$$5V_{out} R_{TRIM} = \frac{23.2k \times V_{out} - 141k}{5 - V_{out}}$$

$$12V_{out} R_{TRIM} = \frac{12.4k \times V_{out} - 181.388k}{12.2087 - V_{out}}$$

Accuracy of adjustment is subject to tolerances of resistors and factory adjusted output accuracy. Vout is equal to the desired output voltage.

## EFFICIENCY VS LOAD

**MTC2S0503MC**

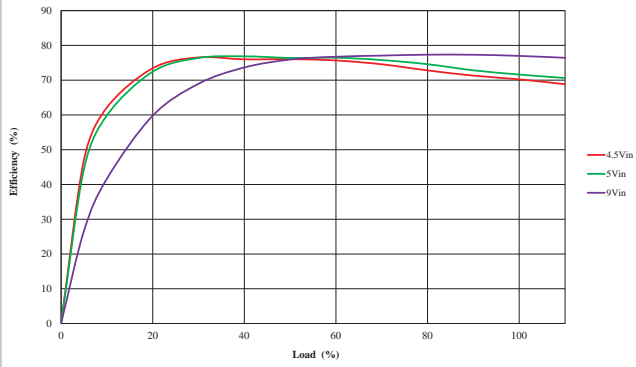

**MTC2S0505MC**

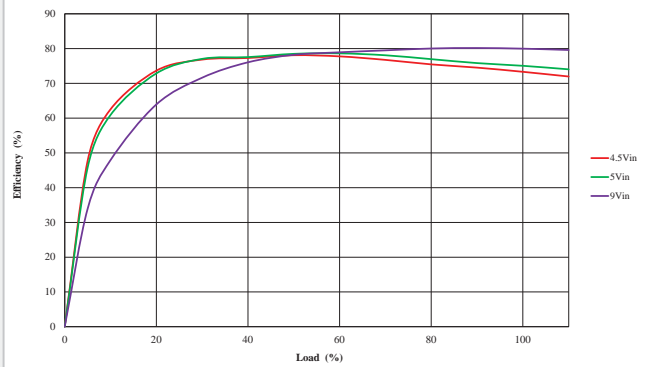

**MTC2S0512MC**

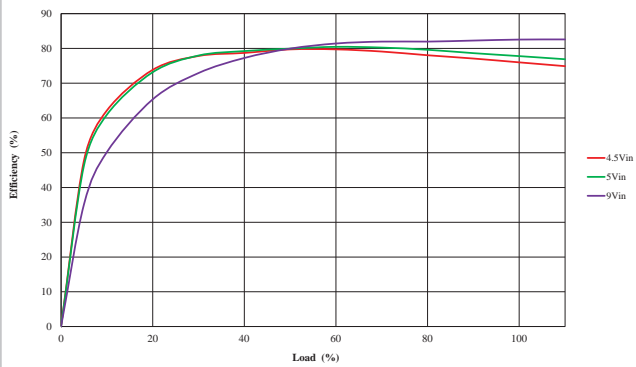

**MTC2S1203MC**

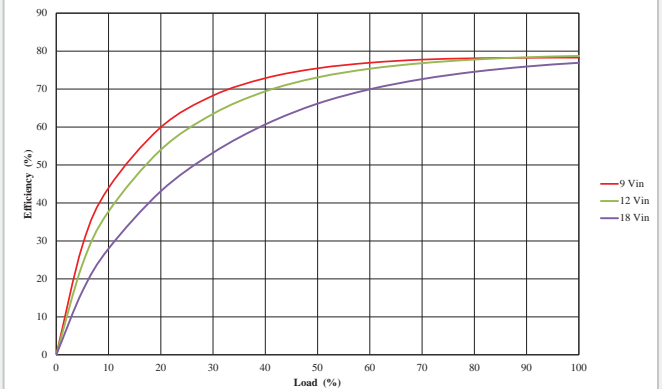

**MTC2S1205MC**

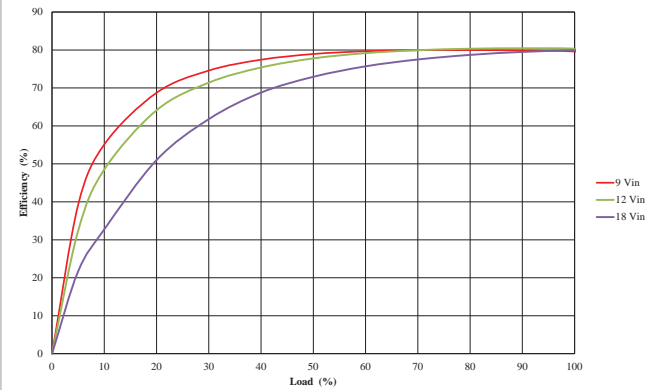

**MTC2S1212MC**

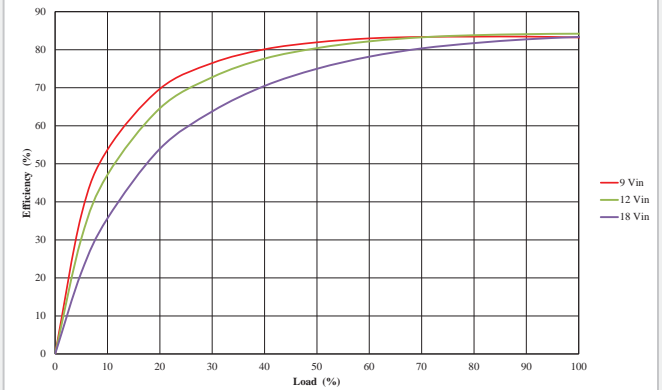

**EFFICIENCY VS LOAD**

**MTC2S2403MC**

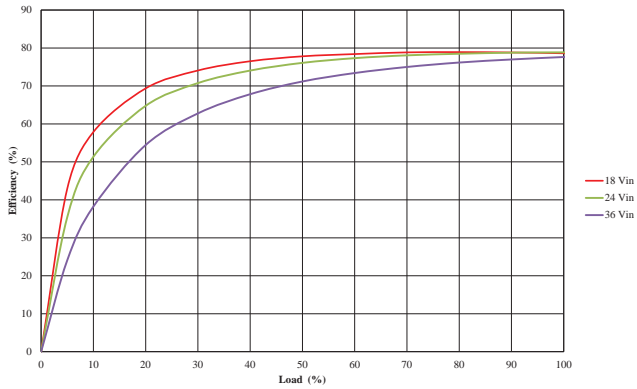

**MTC2S2405MC**

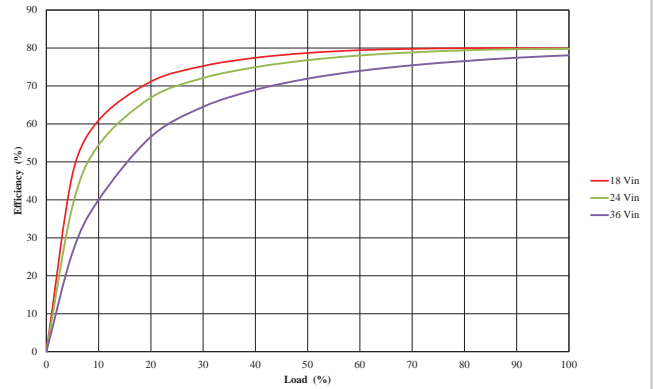

**MTC2S2412MC**

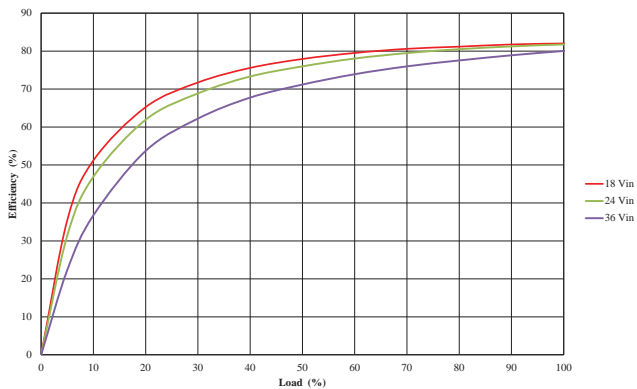

## TEMPERATURE DERATING

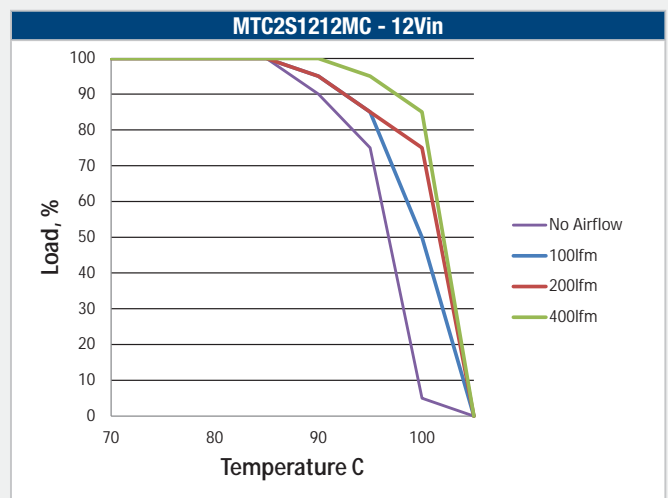
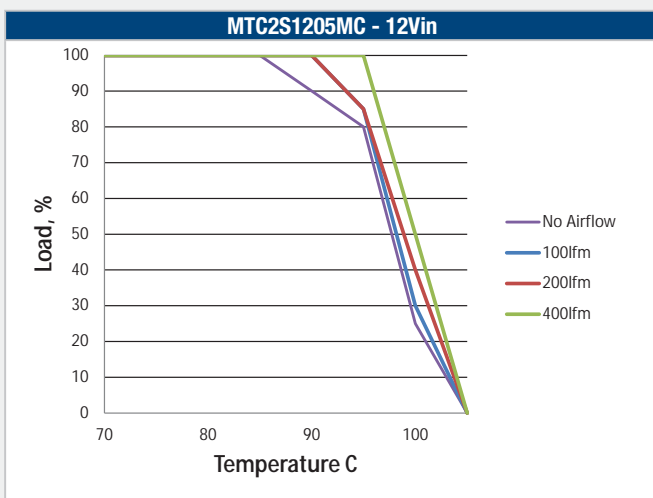
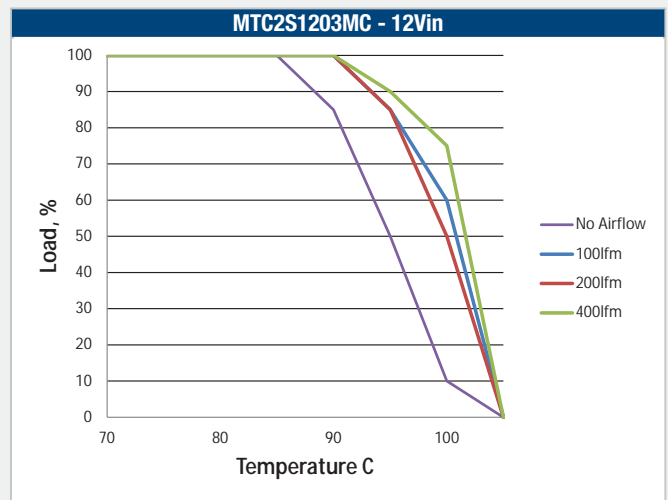
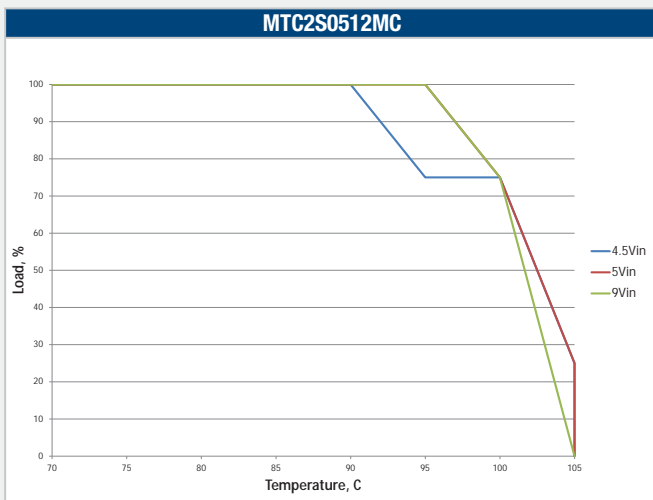
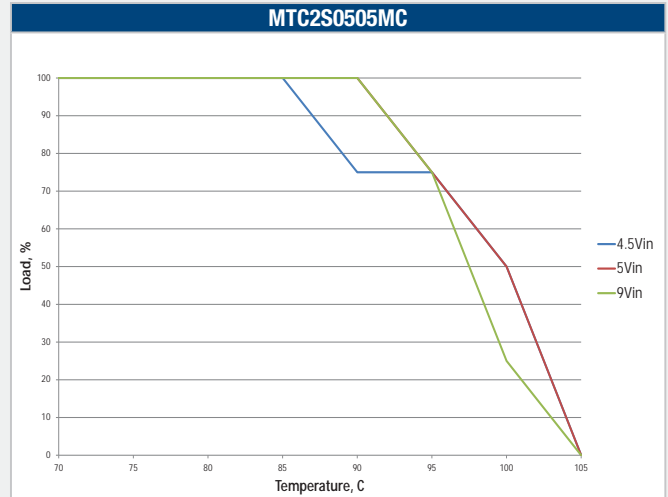
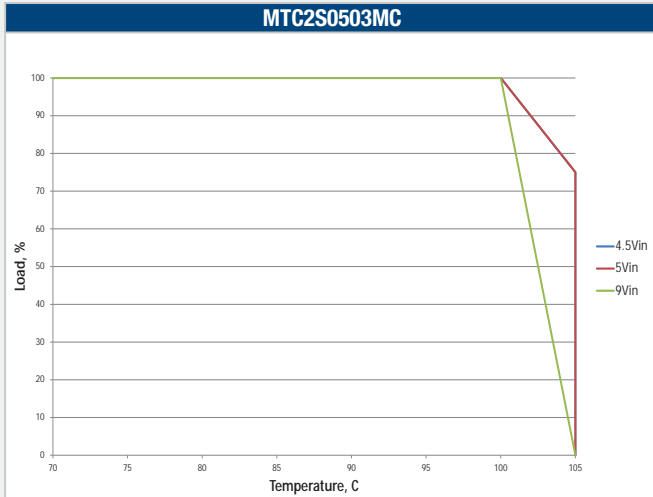

**TEMPERATURE DERATING**

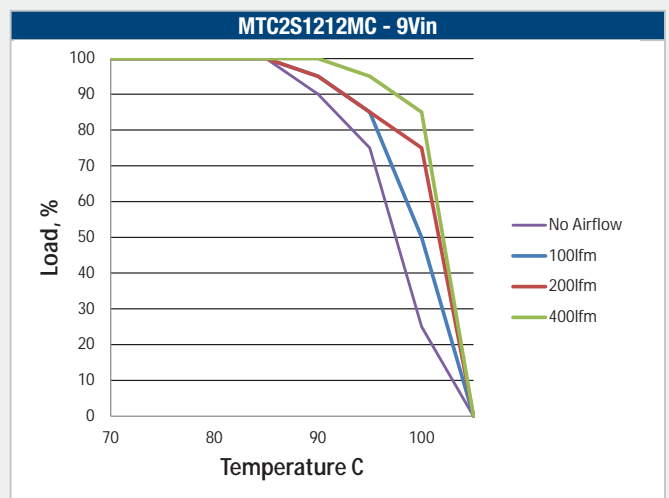
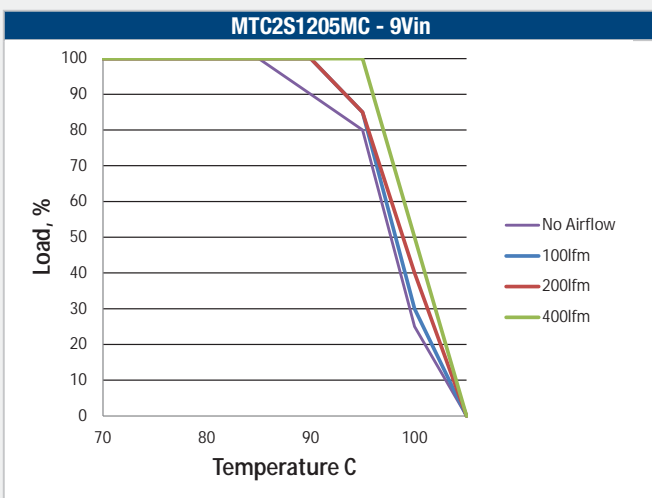
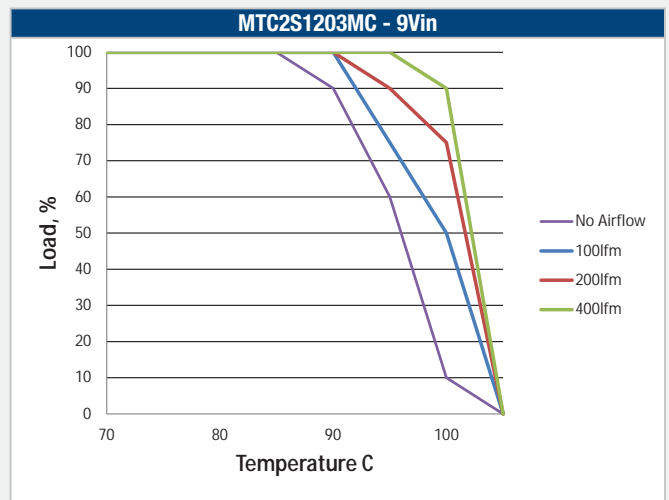
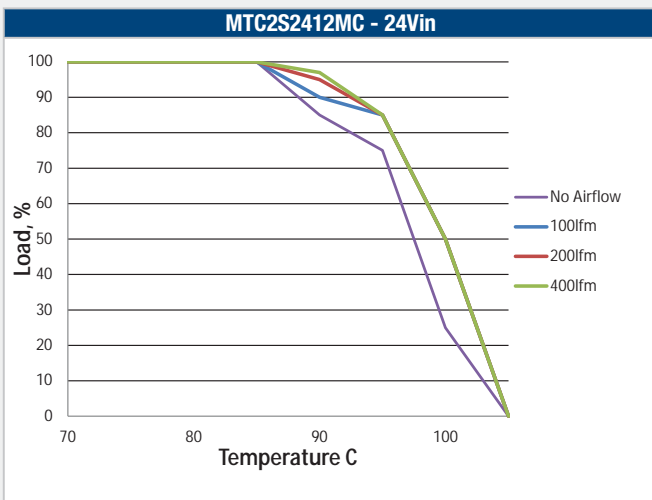
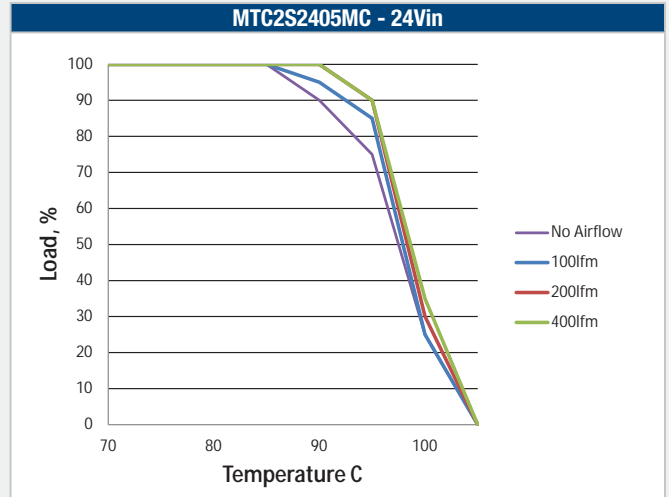
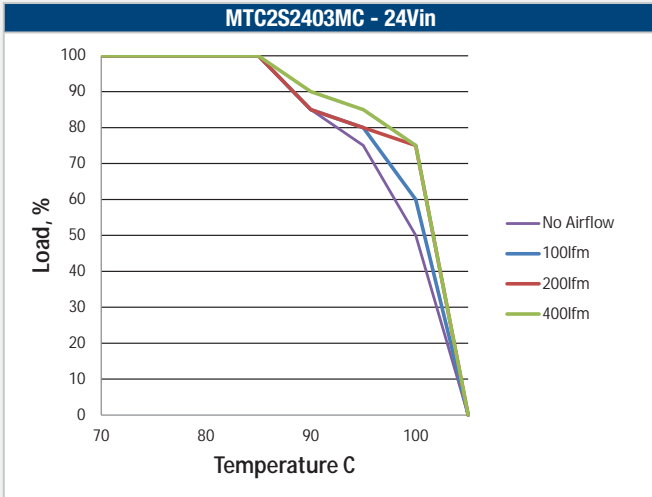

TEMPERATURE DERATING (Continued)

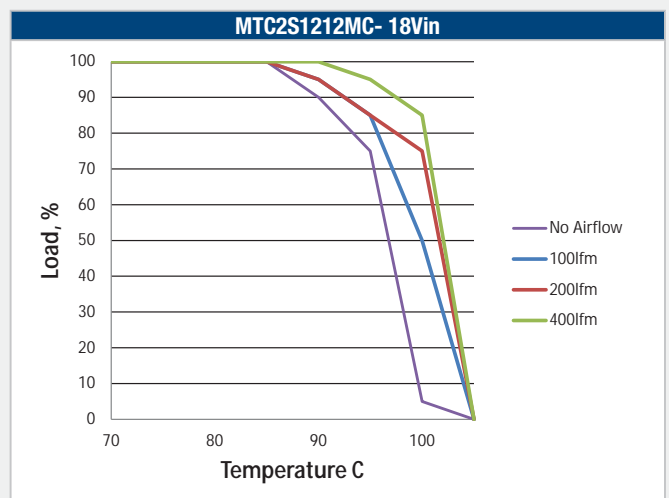
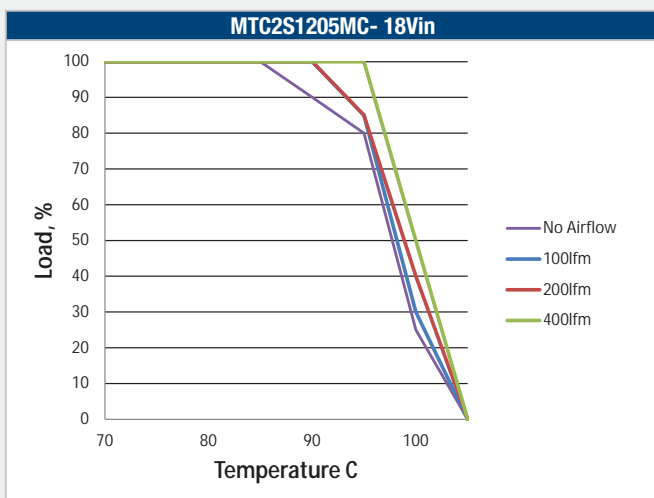
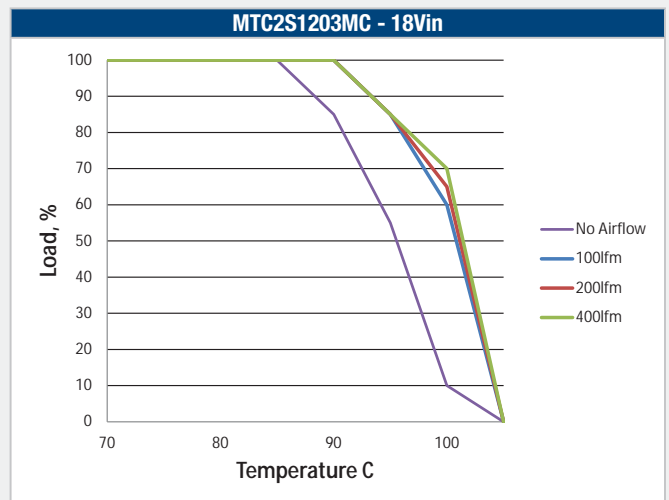
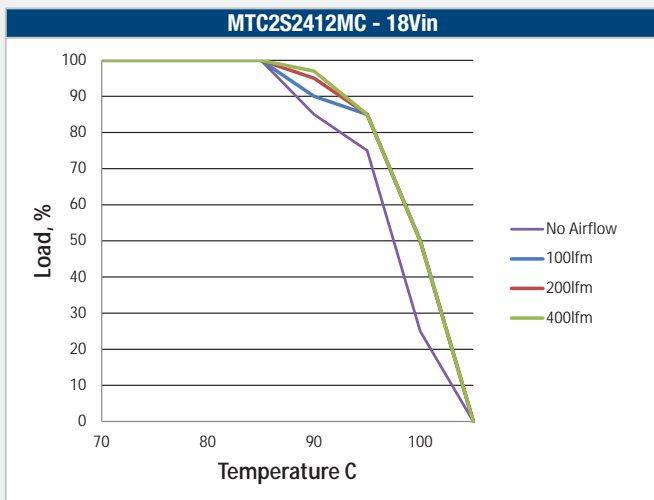
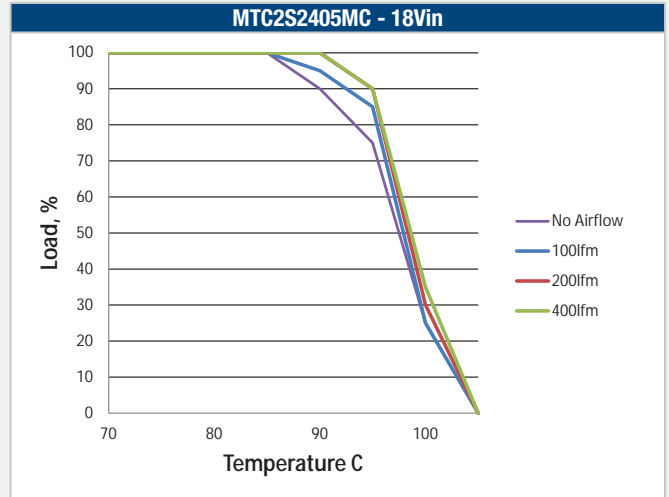
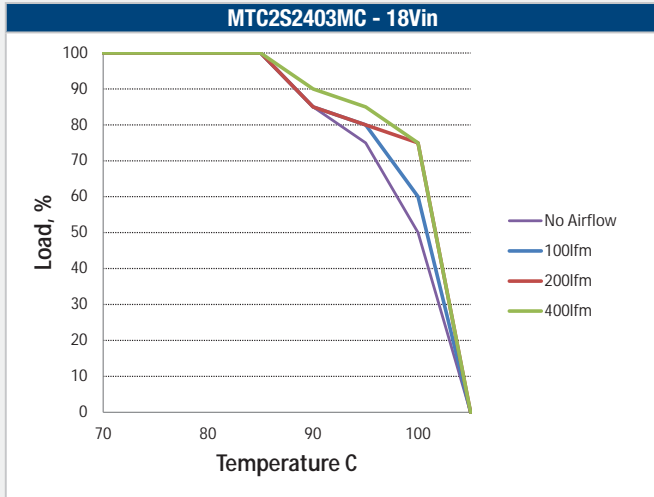

**TEMPERATURE DERATING (Continued)**

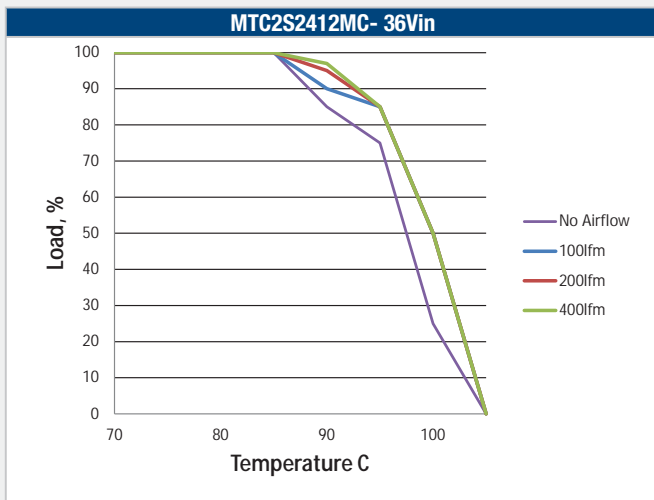
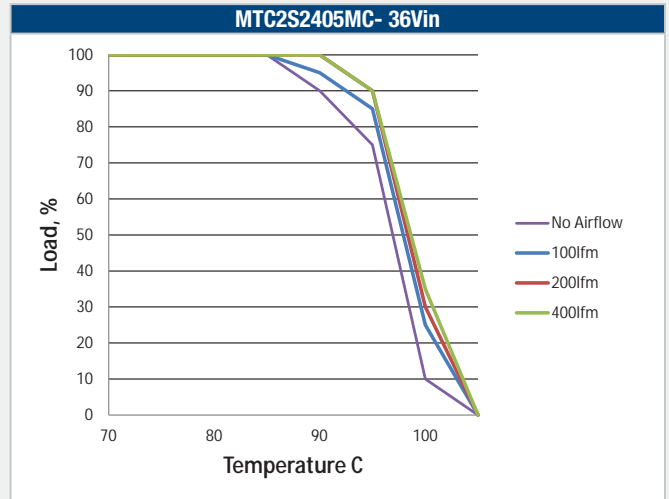
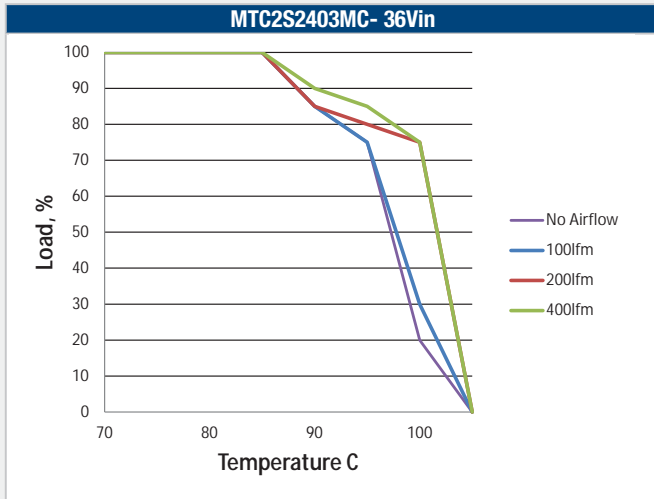

**EMC FILTERING AND SPECTRA**

**FILTERING**

The following table shows the additional input capacitor and input inductor typically required to meet EN 55022 Curve B, Quasi-Peak EMC limit, as shown in the following plots. The following plots show positive and negative quasi peak and CISPR22 Average Limit A (orange line) and Quasi Peak Limit A (blue line) adherence limits.

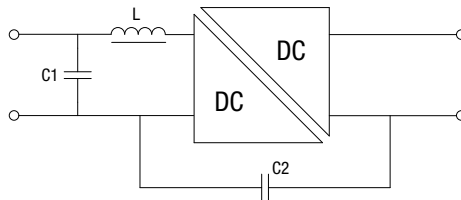

Part Number	Inductor			Capacitor			
	L, $\mu$ H	SMD	Through Hole	C1, $\mu$ F	Recommended Part Number	C2, pF	Recommended Part Number
<b>MTC2S0503MC</b>	6.8	84682C	13R682C	10 & 4.7	GRM31CR71E106KA12L & GCM21BR71C475KA73L	Not required	
<b>MTC2S0505MC</b>	4.7	84472C	13R472C	10 & 4.7	GRM31CR71E106KA12L & GCM21BR71C475KA73L	Not required	
<b>MTC2S0512MC</b>	4.7	84472C	13R472C	10	GRM31CR71E106KA12L	Not required	
<b>MTC2S1203MC</b>	4.7	84472C	13R472C	10	GRM31CR71E106KA12L	Not required	
<b>MTC2S1205MC</b>	4.7	84472C	13R472C	10	GRM31CR71E106KA12L	Not required	
<b>MTC2S1212MC</b>	4.7	84472C	13R472C	10	GRM31CR71E106KA12L	Not required	
<b>MTC2S2403MC</b>	10	84103C	13R103C	10	GCM32EC71H106KA03L	47	DK11XEA470K86RBH01
<b>MTC2S2405MC</b>	10	84103C	13R103C	10	GCM32EC71H106KA03L	68	DE11XRA680KN4AP01F
<b>MTC2S2412MC</b>	10	84103C	13R103C	10	GCM32EC71H106KA03L	47	DK11XEA470K86RBH01

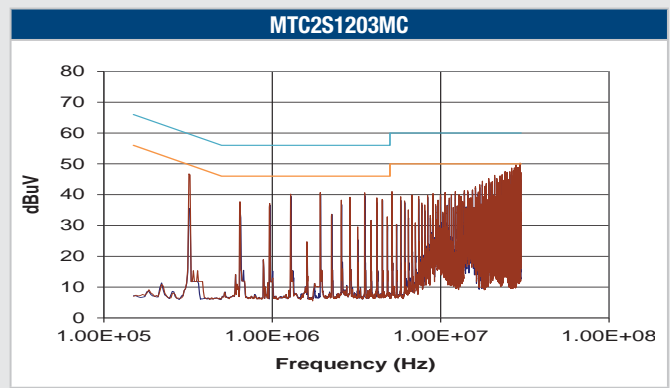
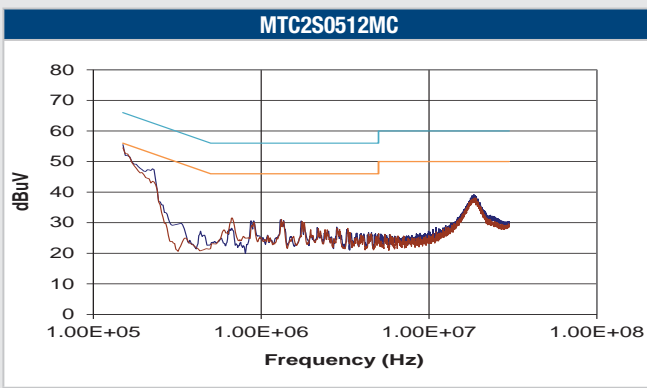
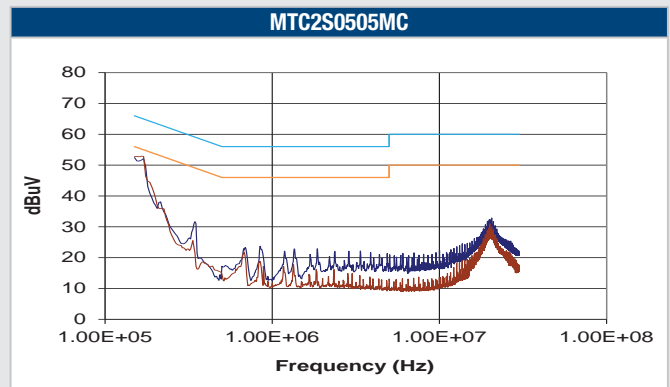
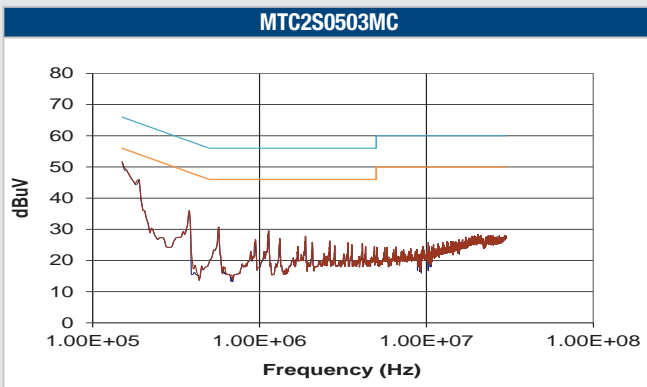

**EMC FILTERING AND SPECTRA (Continued)**

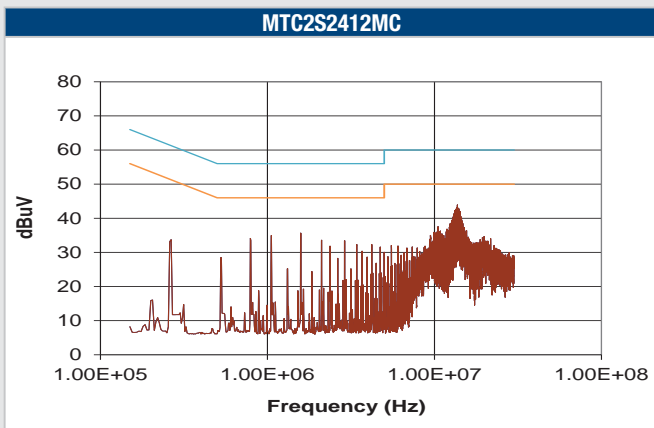
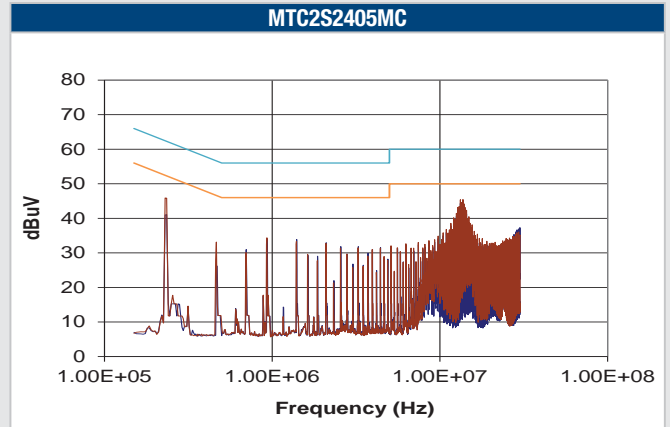
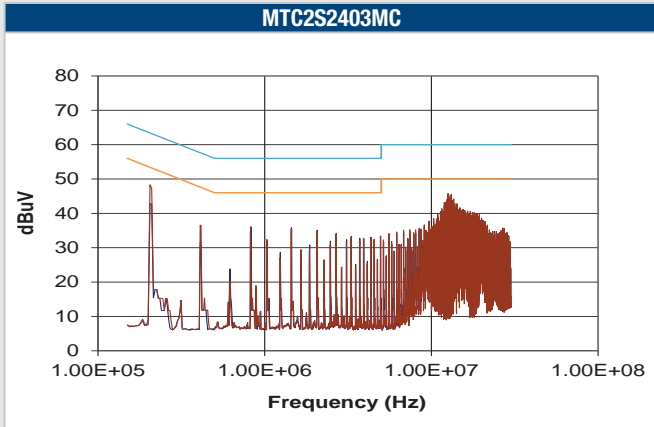
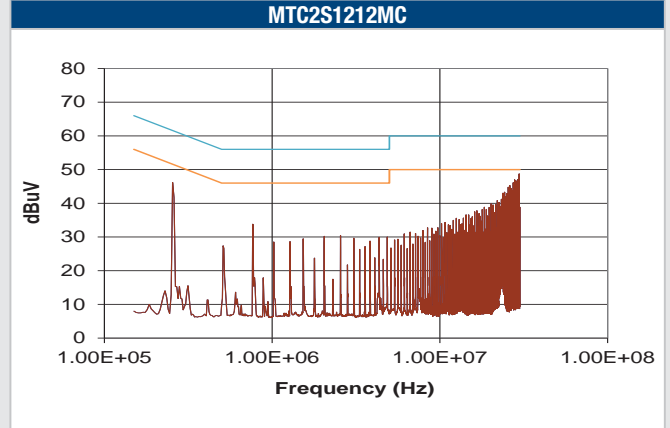
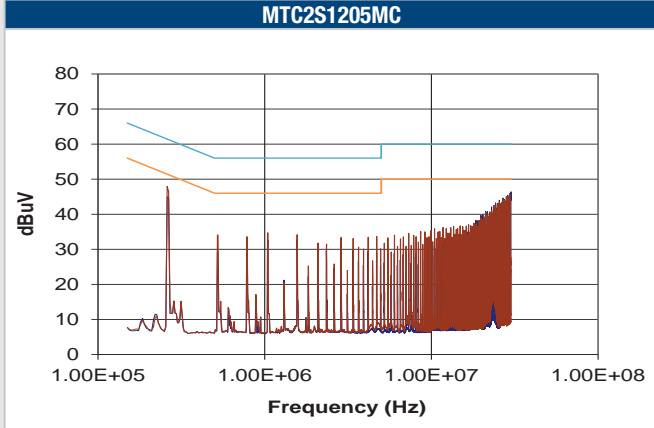



**TAPE & REEL SPECIFICATIONS**

**REEL OUTLINE DIMENSIONS**

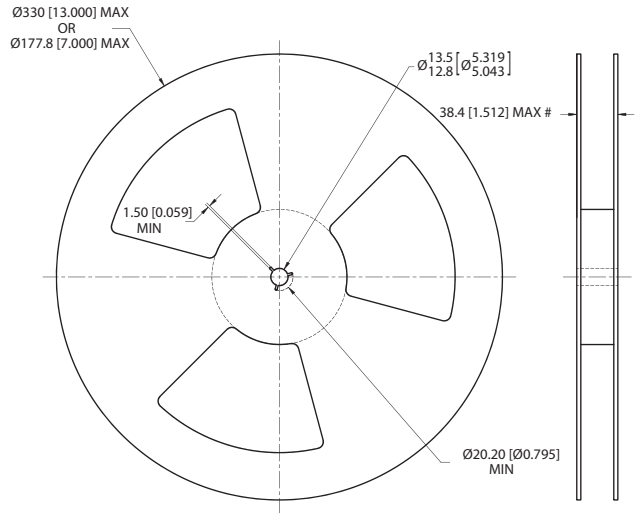

Tape & Reel specifications shall conform with current EIA-481 standard  
 Unless otherwise stated all dimensions in mm (inches)  
 Controlling dimension is mm  
 # Measured at hub

**REEL PACKAGING DETAILS**

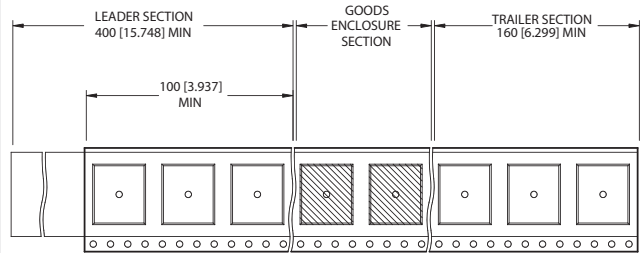

Carrier tape pockets shown are illustrative only - Refer to carrier tape diagram for actual pocket details.  
 Reel Quantity: 7" - 30 or 13" - 150

**TAPE OUTLINE DIMENSIONS**

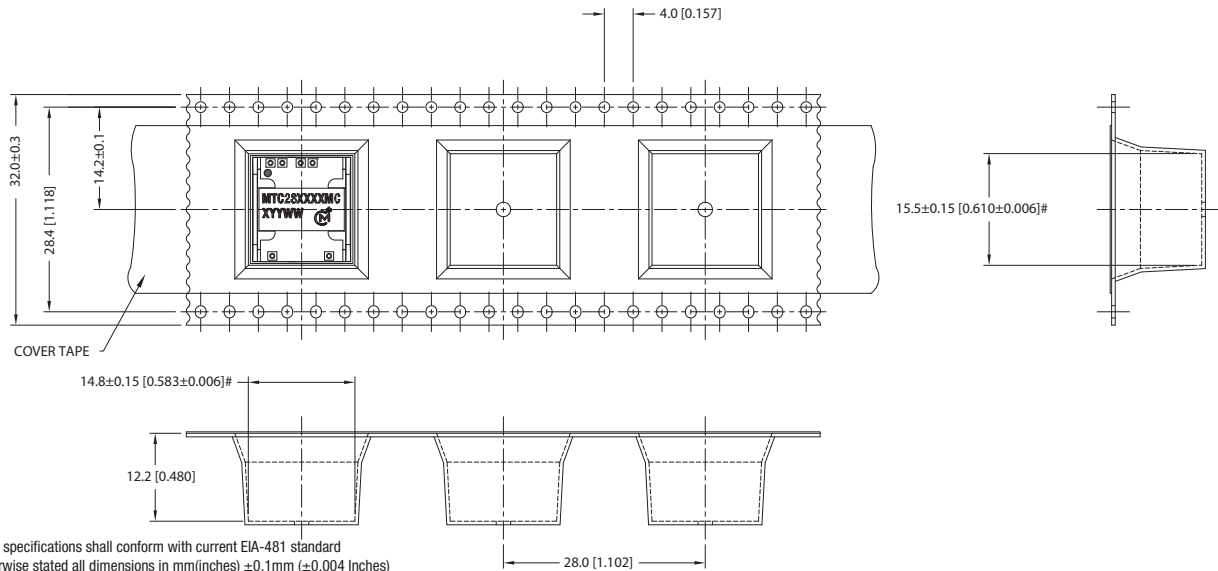

Tape & Reel specifications shall conform with current EIA-481 standard  
 Unless otherwise stated all dimensions in mm (inches) ±0.1mm (±0.004 inches)  
 Controlling dimension is mm  
 Components shall be orientated within the carrier tape as indicated  
 # Measured on a plane 0.3mm above the bottom pocket

DIRECTION OF UNREELING →

**DISCLAIMER**

Unless otherwise stated in the datasheet, all products are designed for standard commercial and industrial applications and NOT for safety-critical and/or life-critical applications.

Particularly for safety-critical and/or life-critical applications, i.e. applications that may directly endanger or cause the loss of life, inflict bodily harm and/or loss or severe damage to equipment/property, and severely harm the environment, a prior explicit written approval from Murata is strictly required. Any use of Murata standard products for any safety-critical, life-critical or any related applications without any prior explicit written approval from Murata shall be deemed unauthorised use.

These applications include but are not limited to:

- Aircraft equipment
- Aerospace equipment
- Undersea equipment
- Power plant control equipment
- Medical equipment
- Transportation equipment (automobiles, trains, ships, etc.)
- Traffic signal equipment
- Disaster prevention / crime prevention equipment
- Data Processing equipment

Murata makes no express or implied warranty, representation, or guarantee of suitability, fitness for any particular use/purpose and/or compatibility with any application or device of the buyer, nor does Murata assume any liability whatsoever arising out of unauthorised use of any Murata product for the application of the buyer. The suitability, fitness for any particular use/purpose and/or compatibility of Murata product with any application or device of the buyer remain to be the responsibility and liability of the buyer.

Buyer represents and agrees that it has all the necessary expertise to create and implement safeguards that anticipate dangerous consequences of failures, monitor failures and their consequences, lessen the likelihood of failures that might cause harm, and take appropriate remedial actions. Buyer will fully indemnify and hold Murata, its affiliated companies, and its representatives harmless against any damages arising out of unauthorised use of any Murata products in any safety-critical and/or life-critical applications.

Remark: Murata in this section refers to Murata Manufacturing Company and its affiliated companies worldwide including, but not limited to, Murata Power Solutions.





This product is subject to the following [operating requirements](#) and the [Life and Safety Critical Application Sales Policy](#):

Refer to: <https://www.murata.com/en-eu/products/power/requirements>

Murata Power Solutions (Milton Keynes) Ltd. makes no representation that the use of its products in the circuits described herein, or the use of other technical information contained herein, will not infringe upon existing or future patent rights. The descriptions contained herein do not imply the granting of licenses to make, use, or sell equipment constructed in accordance therewith. Specifications are subject to change without notice. © 2022 Murata Power Solutions (Milton Keynes) Ltd.

## Looking for pricing, stock, or lifecycle information?

Click below to explore more details on WIN SOURCE:

-  [View MTC2S2405MC-R7 on WIN SOURCE](#)
-  [Murata Power Solutions Inc. Information](#)

## Optimize Your Supply Chain with WIN SOURCE Solutions

-  Global Sourcing Solution
-  Obsolete Management
-  Cost Control Management
-  Shortage Management
-  Alternative Solution
-  Excess Inventory Management