



THE DATASHEET OF
046240054025846+



0.5mm Pitch
SERIES

6240

0.5mmピッチ RA SMT 下接点 ワンタッチロック 小極

0.5mmPitch RA SMT Bottom contact One-touch lock Low-pin count

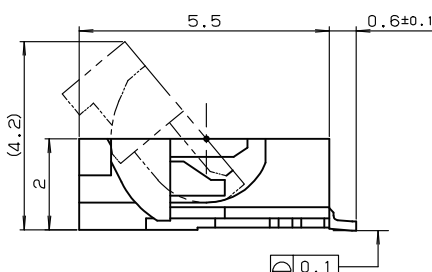
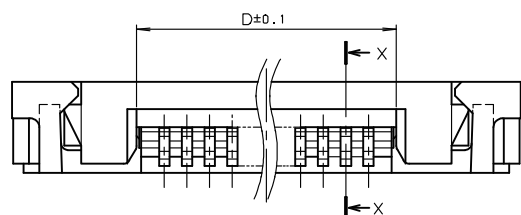
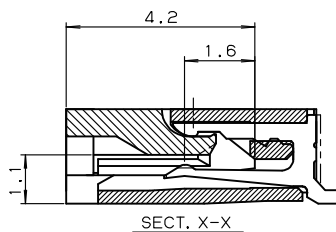
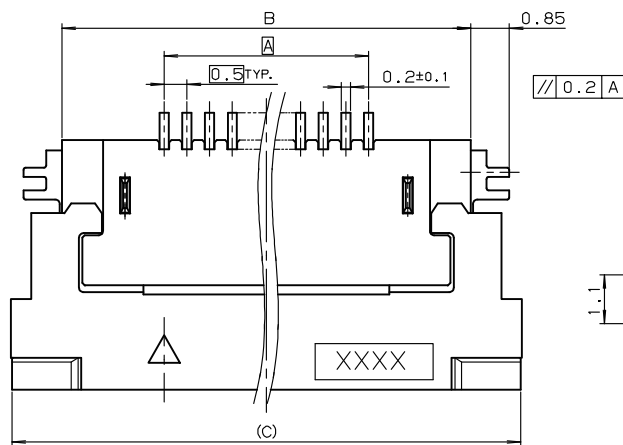

極数 NO. OF POS.	A	B	C	D
5	2.0	6.5	8.7	3.1
6	2.5	7.0	9.2	3.6
7	3.0	7.5	9.7	4.1
8	3.5	8.0	10.2	4.6
9	4.0	8.5	10.7	5.1
10	4.5	9.0	11.2	5.6
11	5.0	9.5	11.7	6.1
12	5.5	10.0	12.2	6.6
13	6.0	10.5	12.7	7.1
14	6.5	11.0	13.2	7.6
15	7.0	11.5	13.7	8.1
16	7.5	12.0	14.2	8.6
17	8.0	12.5	14.7	9.1
18	8.5	13.0	15.2	9.6
19	9.0	13.5	15.7	10.1
20	9.5	14.0	16.2	10.6
21	10.0	14.5	16.7	11.1
22	10.5	15.0	17.2	11.6
23	11.0	15.5	17.7	12.1
24	11.5	16.0	18.2	12.6
25	12.0	16.5	18.7	13.1
26	12.5	17.0	19.2	13.6
27	13.0	17.5	19.7	14.1
28	13.5	18.0	20.2	14.6
29	14.0	18.5	20.7	15.1
30	14.5	19.0	21.2	15.6

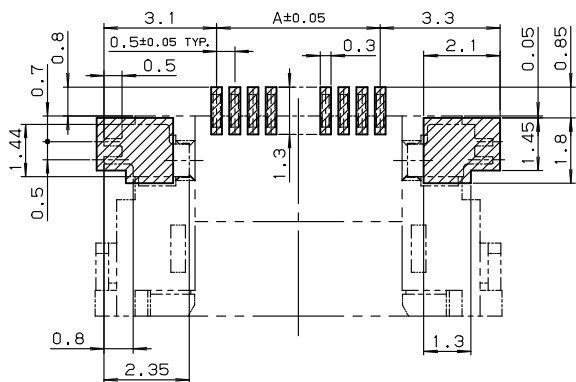

基板取付け寸法
MOUNTING LAYOUT

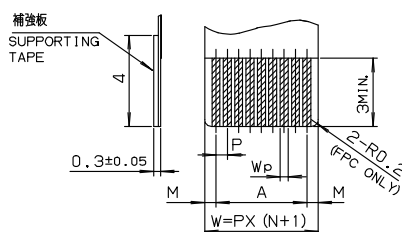

	FPC		FFC	
	1	2	1	2
M	0.5±0.12	0.5±0.1	0.5±0.1	0.5±0.08
P	0.5±0.02	0.5±0.05	0.5±0.03	0.5±0.05
A	A±0.03	A±0.05	A±0.03	A±0.05
W	W±0.07	W±0.07	W±0.07	W±0.07
Wp	0.35 ^{+0.04} _{-0.03}	0.35±0.05	0.3 ^{+0.05} _{-0.02}	0.3 ^{+0.05} _{-0.02}

適用FPC, FFC寸法
APPLICABLE FPC, FFC

注文コード ORDERING CODE

04 6240 0XX 0X6 XXX+

RoHS 対応品

RoHS Compliant Product

006 800+ : スズ銅めっき Sn-Cu Plated
026 846+ : 金めっき Au Plated

極数 NUMBER OF POSITIONS

生産対応可能極数については、営業部に
ご確認願います。

Feel free to contact our sales department
for available numbers of positions.

0.5mm Pitch
SERIES

6240

0.5mmピッチ RA SMT 下接点 ワンタッチロック 中極

0.5mmPitch RA SMT Bottom contact One-touch lock Medium-pin count

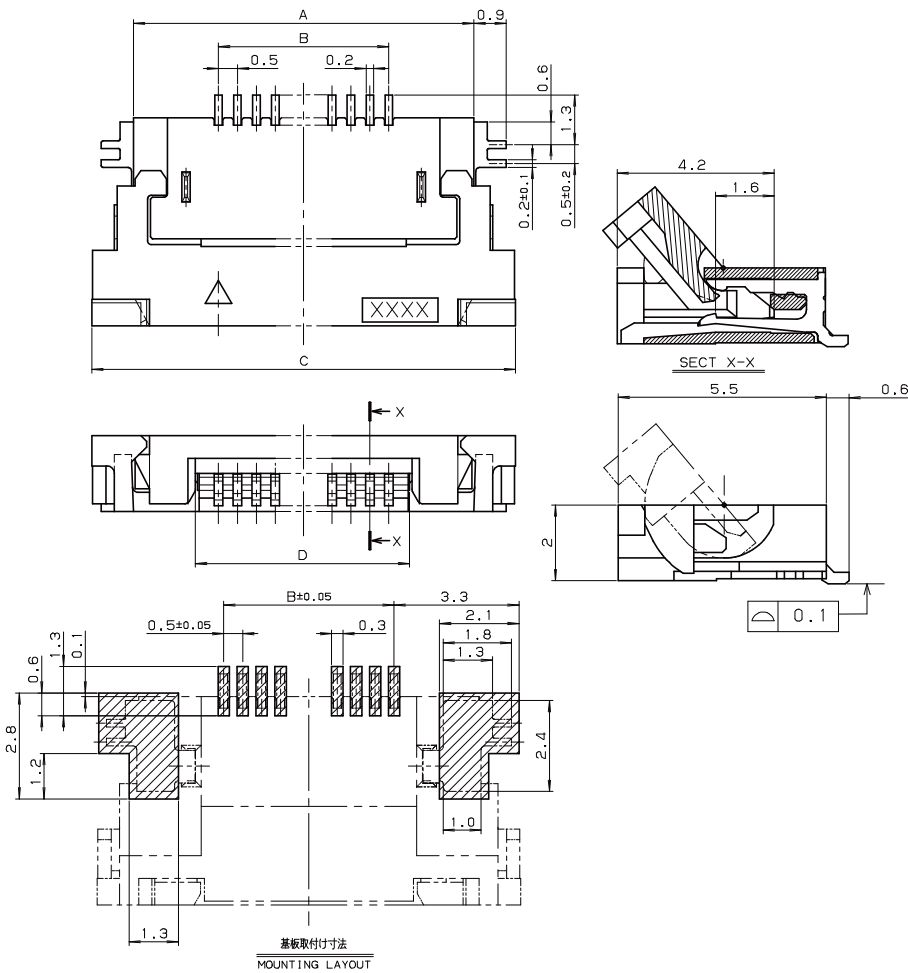

極数 NO. OF POS.	A	B	C	D
31	19.5	15.0	21.7	16.1
32	20.0	15.5	22.2	16.6
33	20.5	16.0	22.7	17.1
34	21.0	16.5	23.2	17.6
35	21.5	17.0	23.7	18.1
36	22.0	17.5	24.2	18.6
37	22.5	18.0	24.7	19.1
38	23.0	18.5	25.2	19.6
39	23.5	19.0	25.7	20.1
40	24.0	19.5	26.2	20.6
41	24.5	20.0	26.7	21.1
42	25.0	20.5	27.2	21.6
43	25.5	21.0	27.7	22.1
44	26.0	21.5	28.2	22.6
45	26.5	22.0	28.7	23.1
46	27.0	22.5	29.2	23.6
47	27.5	23.0	29.7	24.1
48	28.0	23.5	30.2	24.6
49	28.5	24.0	30.7	25.1
50	29.0	24.5	31.2	25.6

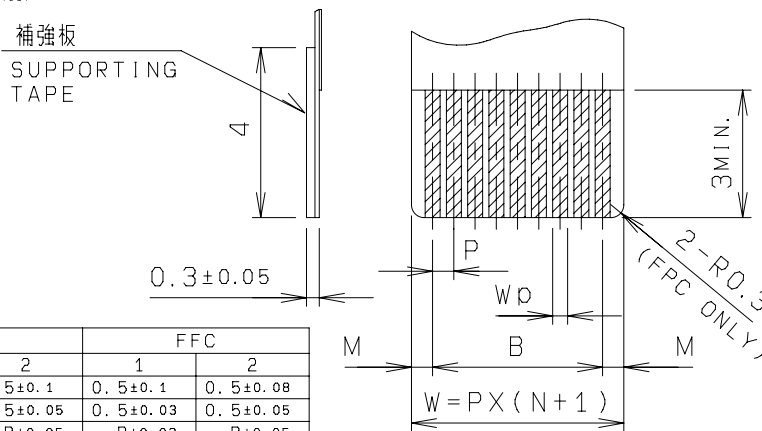

	FPC		FFC	
	1	2	1	2
M	0.5±0.12	0.5±0.1	0.5±0.1	0.5±0.08
P	0.5±0.02	0.5±0.05	0.5±0.03	0.5±0.05
B	B±0.03	B±0.05	B±0.03	B±0.05
W	W±0.07	W±0.07	W±0.07	W±0.07
WD	0.35 ^{+0.04} _{-0.03}	0.35±0.05	0.3 ^{+0.05} _{-0.02}	0.3 ^{+0.05} _{-0.02}

適用FPC, FFC寸法

注文コード ORDERING CODE

04 6240 0XX 0X3 XXX+

RoHS 対応品

RoHS Compliant Product

003 800+ : スズ銅めっき Sn-Cu Plated
023 846+ : 金めっき Au Plated

極数 NUMBER OF POSITIONS

生産対応可能極数については、営業部にご確認願います。

Feel free to contact our sales department for available numbers of positions.

0.5mm Pitch
SERIES

6240

0.5mmピッチ RA SMT 下接点 ワンタッチロック 大極
0.5mmPitch RA SMT Bottom contact One-touch lock High-pin count

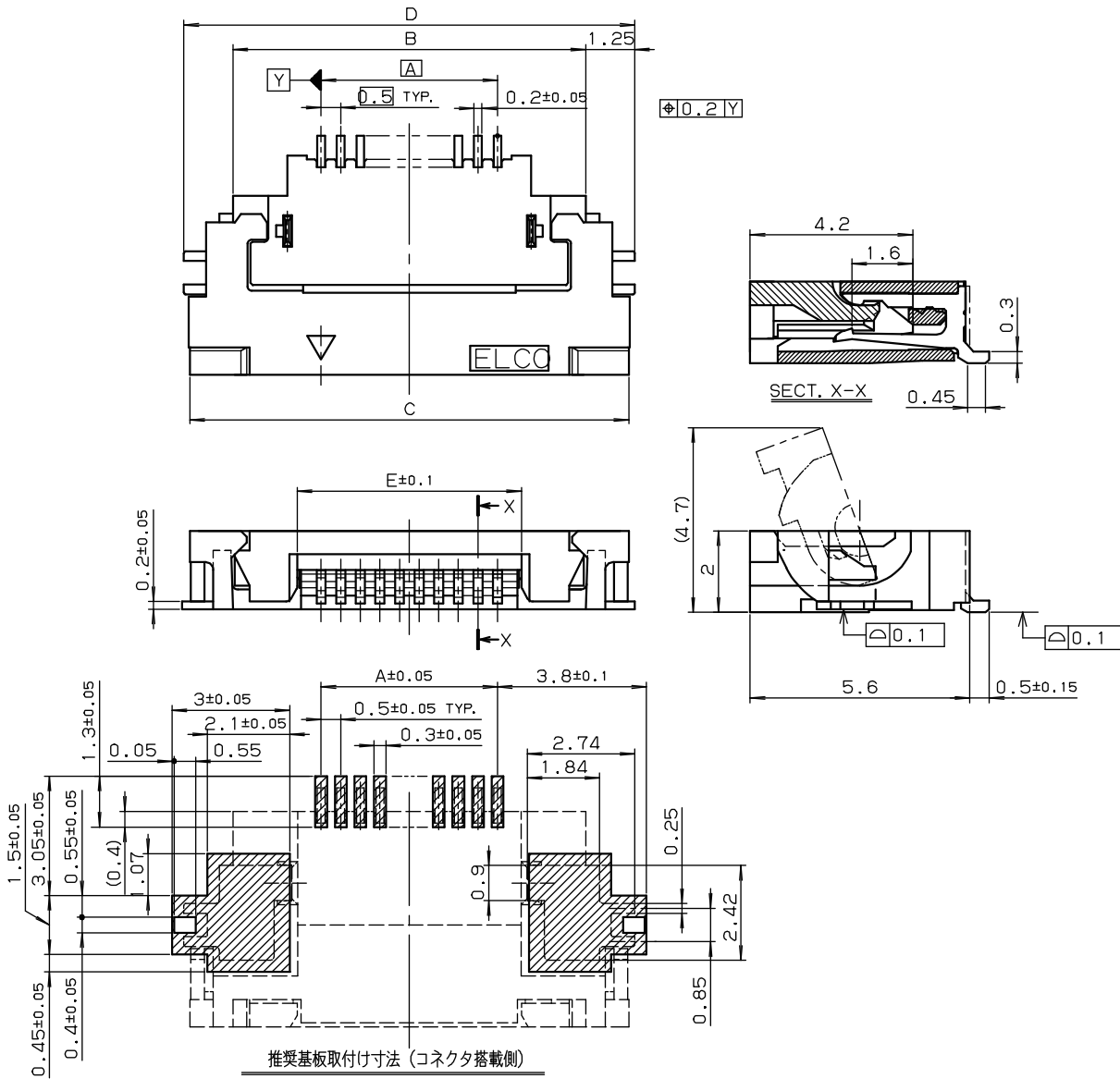

MOUNTING LAYOUT (CONN. MOUNTING SIDE)

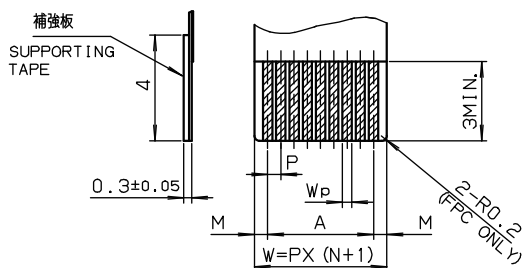

	FPC		FFC	
	1	2	1	2
M	0.5±0.12	0.5±0.1	0.5±0.1	0.5±0.06
P	0.5±0.02	0.5±0.05	0.5±0.03	0.5±0.05
A	A±0.03	A±0.05	A±0.03	A±0.05
W	W±0.07	W±0.07	W±0.07	W±0.07
Wp	0.35 ^{+0.04} _{-0.03}	0.35±0.05	0.3 ^{+0.05} _{-0.02}	0.3 ^{+0.05} _{-0.02}

適用FPC, FFC寸法
APPLICABLE FPC, FFC

極数 NO. OF POS.	寸法 DIMENSION				
	A	B	C	D	E
51	25.0	29.5	31.7	32.0	26.17
52	25.5	30.0	32.2	32.5	26.67
53	26.0	30.5	32.7	33.0	27.17
54	26.5	31.0	33.2	33.5	27.67
55	27.0	31.5	33.7	34.0	28.17
56	27.5	32.0	34.2	34.5	28.67
57	28.0	32.5	34.7	35.0	29.17
58	28.5	33.0	35.2	35.5	29.67
59	29.0	33.5	35.7	36.0	30.17
60	29.5	34.0	36.2	36.5	30.67

注文コード ORDERING CODE
04 6240 0XX 0X5 XXX+

RoHS 対応品
RoHS Compliant Product

005 800+ : スズ銅めっき Sn-Cu Plated
025 846+ : 金めっき Au Plated

極数 NUMBER OF POSITIONS

生産対応可能極数については、営業部に
ご確認ください。

Feel free to contact our sales department
for available numbers of positions.

0.5mm Pitch
SERIES

6240

エンボス梱包品
Tape and Reel Package

●5~50 POSITIONS

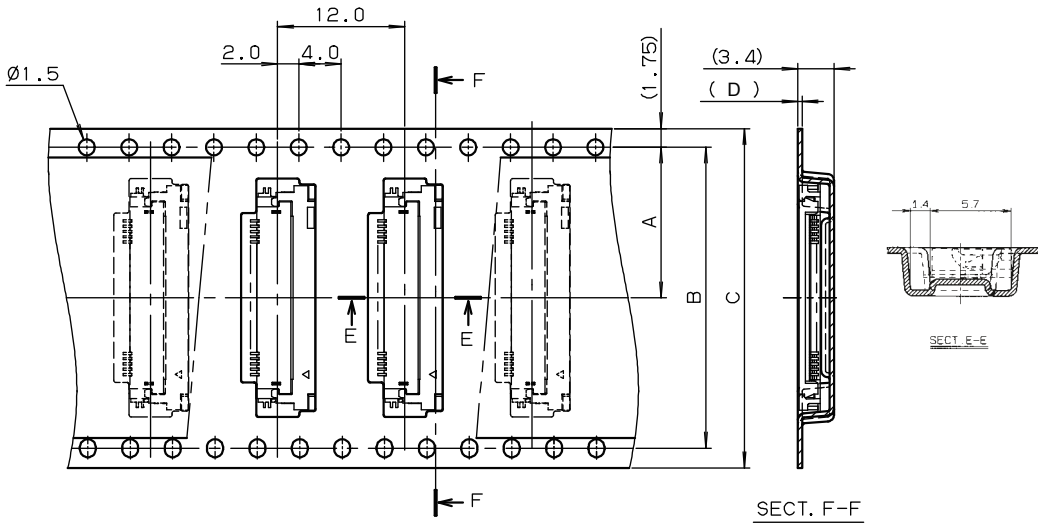

極数 NO. OF POS.	A	B	C	D
5	11.5	—	24	0.4
6	11.5	—	24	0.4
7	11.5	—	24	0.4
8	11.5	—	24	0.4
9	11.5	—	24	0.4
10	11.5	—	24	0.4
11	11.5	—	24	0.4
12	11.5	—	24	0.4
13	11.5	—	24	0.4
14	11.5	—	24	0.4
15	11.5	—	24	0.4
16	11.5	—	24	0.4
17	11.5	—	24	0.4
18	11.5	—	24	0.4
19	11.5	—	24	0.4
20	14.2	28.4	32	0.4
21	14.2	28.4	32	0.4
22	14.2	28.4	32	0.4
23	14.2	28.4	32	0.4
24	14.2	28.4	32	0.4
25	14.2	28.4	32	0.4
26	14.2	28.4	32	0.4
27	14.2	28.4	32	0.4
28	14.2	28.4	32	0.4
29	14.2	28.4	32	0.4
30	14.2	28.4	32	0.4

極数 NO. OF POS.	A	B	C	D
31	20.2	40.4	44	0.3
32	20.2	40.4	44	0.3
33	20.2	40.4	44	0.3
34	20.2	40.4	44	0.3
35	20.2	40.4	44	0.3
36	20.2	40.4	44	0.3
37	20.2	40.4	44	0.3
38	20.2	40.4	44	0.3
39	20.2	40.4	44	0.3
40	20.2	40.4	44	0.3
41	20.2	40.4	44	0.3
42	20.2	40.4	44	0.3
43	20.2	40.4	44	0.3
44	20.2	40.4	44	0.3
45	20.2	40.4	44	0.3
46	20.2	40.4	44	0.3
47	20.2	40.4	44	0.3
48	20.2	40.4	44	0.3
49	20.2	40.4	44	0.3
50	20.2	40.4	44	0.3

注文コード ORDERING CODE
04 6240 0XX 0X6 XXX+

RoHS 対応品
RoHS Compliant Product

006 800+ : スズ銅めっき Sn-Cu Plated
026 846+ : 金めっき Au Plated

極数 NUMBER OF POSITIONS

注文コード ORDERING CODE
04 6240 0XX 0X3 XXX+

RoHS 対応品
RoHS Compliant Product

003 800+ : スズ銅めっき Sn-Cu Plated
023 846+ : 金めっき Au Plated

極数 NUMBER OF POSITIONS

●51~60 POSITIONS

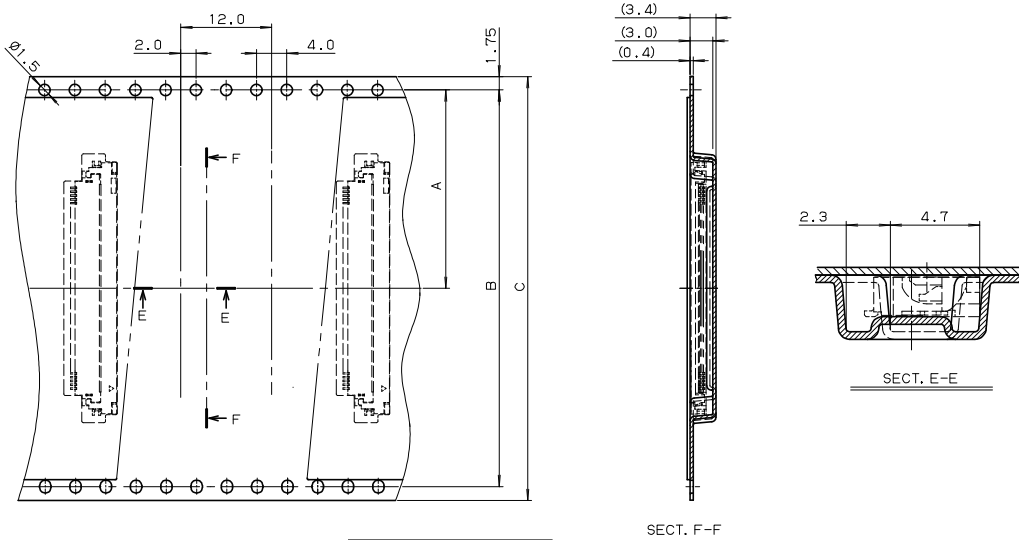

極数 NO. OF POS.	A	B	C
51	26.5	52.4	56.0
52	26.5	52.4	56.0
53	26.5	52.4	56.0
54	26.5	52.4	56.0
55	26.5	52.4	56.0
56	26.5	52.4	56.0
57	26.5	52.4	56.0
58	26.5	52.4	56.0
59	26.5	52.4	56.0
60	26.5	52.4	56.0

注文コード ORDERING CODE
04 6240 0XX 0X5 XXX+

RoHS 対応品
RoHS Compliant Product

005 800+ : スズ銅めっき Sn-Cu Plated
025 846+ : 金めっき Au Plated

極数 NUMBER OF POSITIONS

生産対応可能極数については、営業部にご確認願います。

Feel free to contact our sales department for available numbers of positions.







梱包数量 2000個/リール
PACKING QUANTITY : 2000/Reel

Looking for pricing, stock, or lifecycle information?

Click below to explore more details on WIN SOURCE:

-  [View 046240054025846+ on WIN SOURCE](#)
-  [AVX Corp/Kyocera Corp](#) Information

Optimize Your Supply Chain with WIN SOURCE Solutions

-  Global Sourcing Solution
-  Obsolete Management
-  Cost Control Management
-  Shortage Management
-  Alternative Solution
-  Excess Inventory Management