



**THE DATASHEET OF
SS-5H-1A-APH**



SS-5H

250/300 V Subminiature, radial leaded, time-delay fuses

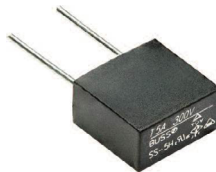

Product features

- Radial leaded, time delay with high breaking capacity
- Designed to IEC60127-3
- Plastic cap and base, flammability UL 94V0
- Protects against harmful overcurrents in primary and secondary applications
- Small rectangular-leaded design utilizes less board space
- High frequency vibration: MIL-STD-202F, Method 201A

Applications

Primary and secondary circuit protection:

- Power supplies
- Notebooks and laptops
- Appliances and white goods
- Lighting ballasts
- Power adapters
- Set top boxes
- LED/LCD televisions and displays
- Air conditioners
- Battery chargers

Agency information

- UL Recognition: File E19180, Guide JDYX2/JDYX8
- VDE: 40031800
- TUV: J50190080
- CCC: self-declaration 2020970207000250
- PSE: JET 1641-31007-1006 (1 A - 5 A); JET 1641-31007-1007 (6.3 A)
- KC: SU05011-11001 (1 A ~ 2.5 A); SU05011-11002 (3.15 A ~ 6.3 A)

Ordering

- The ordering code is the part number replacing the "." with a "-" plus adding the packaging suffix (i.e. SS-5H-1.25A; SS-5H-1-25A-BK)

Packaging suffixes

250 V Version

- -AP (1000 parts Ammo pack, Pitch =12.7 mm)
- -BK (200 parts in a polybag, Lead L=4.3 ±0.3 mm)
- -BK2 (200 parts in a polybag, Lead L=21 ±3.0 mm)

300 V Version

- -APH (1000 parts Ammo pack, Pitch =12.7 mm)
- -BKH (200 parts in a polybag, Lead L=4.3 ±0.3 mm)
- -BK2H (200 parts in a polybag, Lead L=21 ±3.0 mm)

Electrical characteristics

I_n	$1.5I_n$ min minute	$2.1I_n$ max minute	$2.75I_n$ min ms	$2.75I_n$ max s	$4I_n$ min ms	$4I_n$ max s	$10I_n$ min ms	$10I_n$ max ms
1A - 6.3A	60	2	400	10	150	3	20	150

Product specifications

Part number	Current rating (A)	Voltage rating ¹ (Vac)	Interrupting rating at rated voltage (50Hz) AC (A)	Typical DC cold resistance ² (mΩ)	Typical melting ³ I ² t (A ² s)	Typical voltage drop ⁴ (mV)	VDE ¹	TUV ¹	CURUs ¹	CCC ¹	KC ¹	PSE+JET ¹
SS-5H-1A	1.0	250/300	100	78	7.4	94.5	X	X	X	X	X	X
SS-5H-1.25A	1.25	250/300	100	57	12.8	87	X	X	X	X	X	X
SS-5H-1.6A	1.6	250/300	100	43	23	79	X	X	X	X	X	X
SS-5H-2A	2.0	250/300	100	31.2	29.8	75	X	X	X	X	X	X
SS-5H-2.5A	2.5	250/300	100	23.0	40.3	73.5	X	X	X	X	X	X
SS-5H-3.15A	3.15	250/300	100	17.5	67	62.5	X	X	X	X	X	X
SS-5H-4A	4.0	250/300	100	12	87	60.5	X	X	X	X	X	X
SS-5H-5A	5.0	250/300	100	7.35	120	43	X	X	X	X	X	X
SS-5H-6.3A	6.3	250/300	100	7.4	176	59	X	X	X	X	X	X

- CCC and KC-Mark voltage rating only 250 Vac. VDE, TUV, cURus and PSE voltage ratings given at both 250 Vac and 300 Vac
- Typical cold resistance (measured at <10% of rated current)
- I²t value is measured at 10I_n DC
- Typical voltage drop (voltage drop was measured at +20 °C ambient temperature at rated current)

Dimensions and packaging (mm)

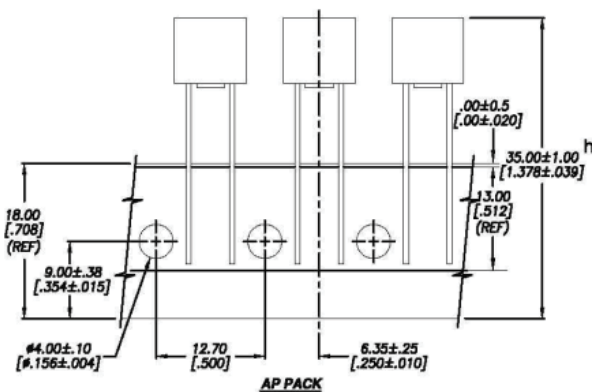
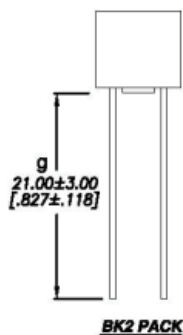
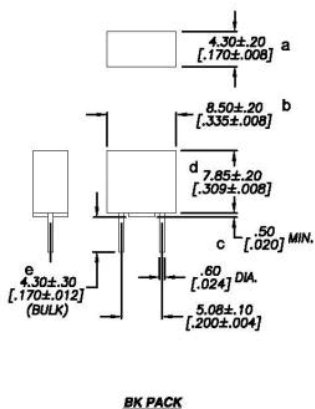

Time vs. current curve

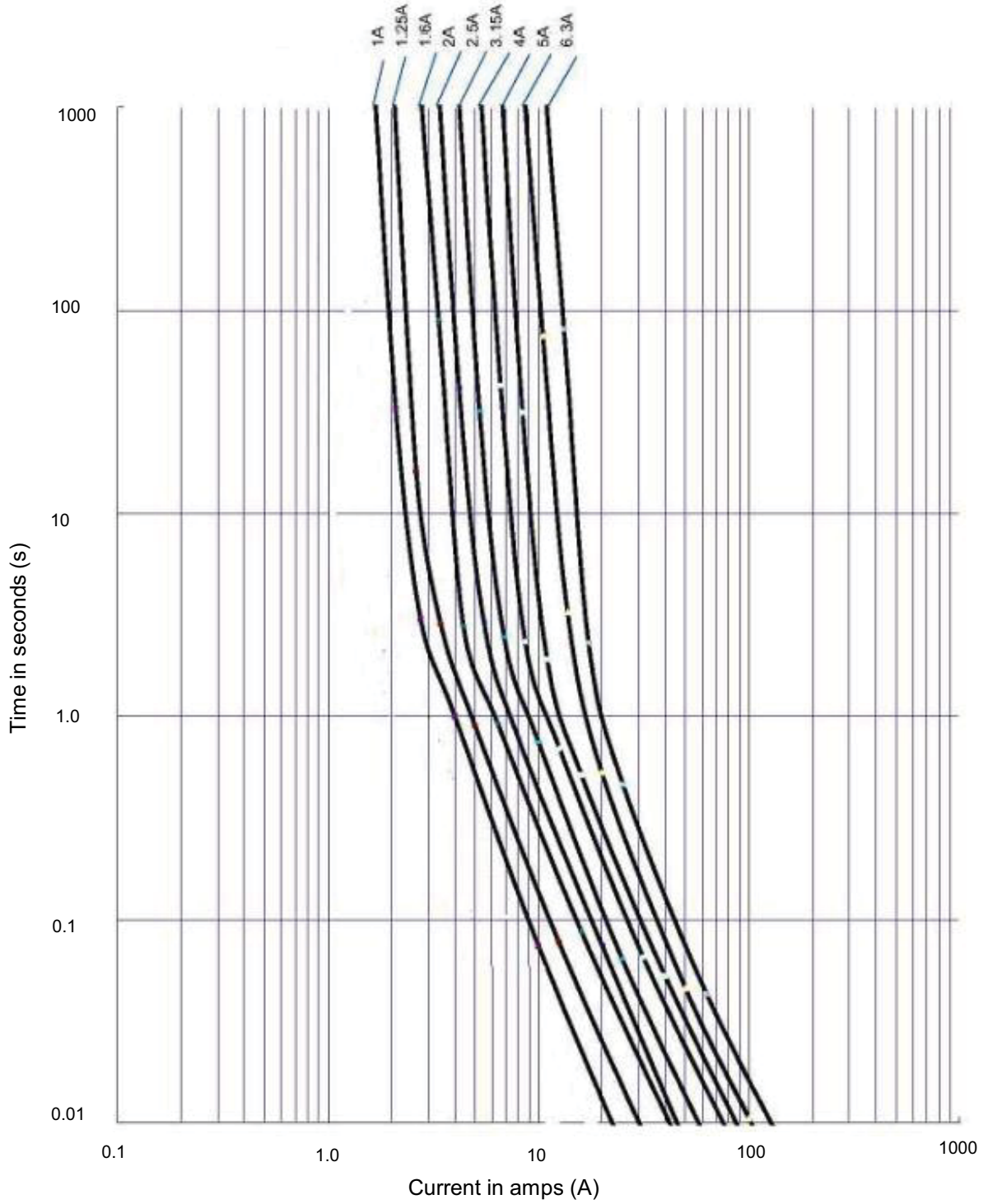

Temperature derating curve

Normal operating temperature: +25 °C±2 °C

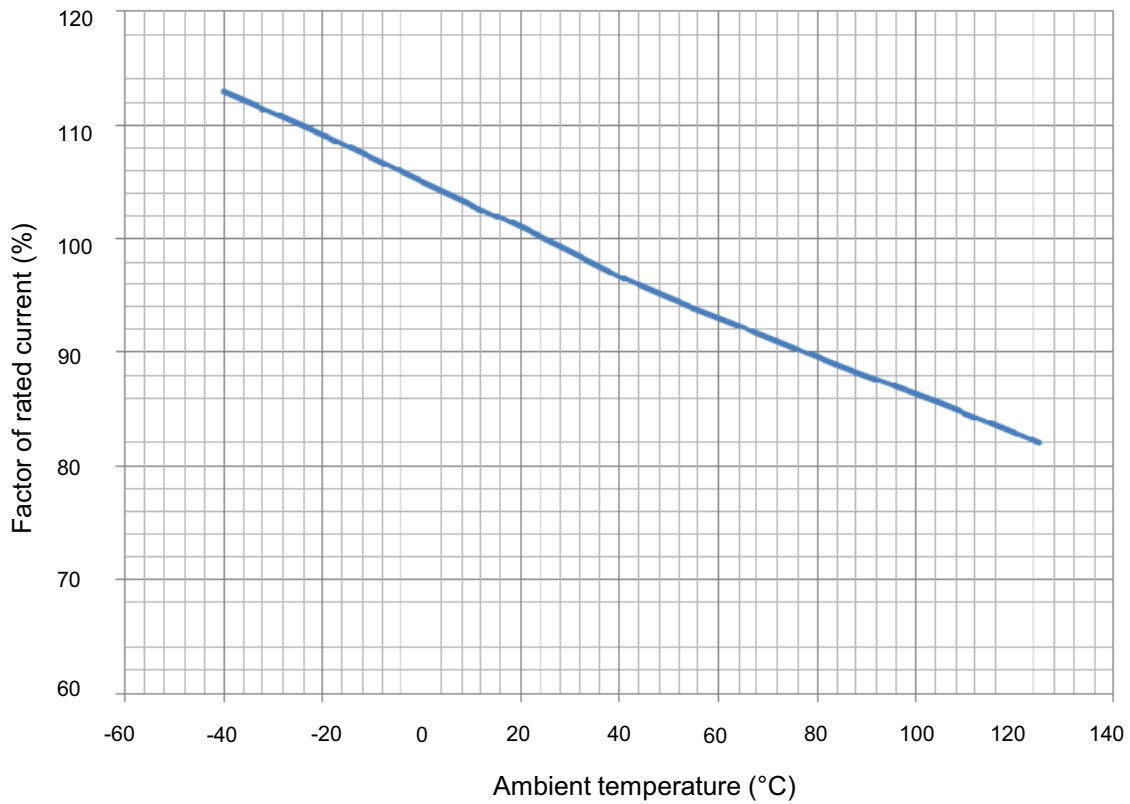

General specifications

Operating temperature -40 °C to +125 °C w ith proper correction factor applied

Storage temperature -10 °C to +40 °C

Solderability-EIA-186-9E Method 9

High Frequency Vibration Test-Withstands 10-55Hz per MIL-STD-202F, Method 201A

Endurance Test-IEC60127-3/4

Wave solder profile

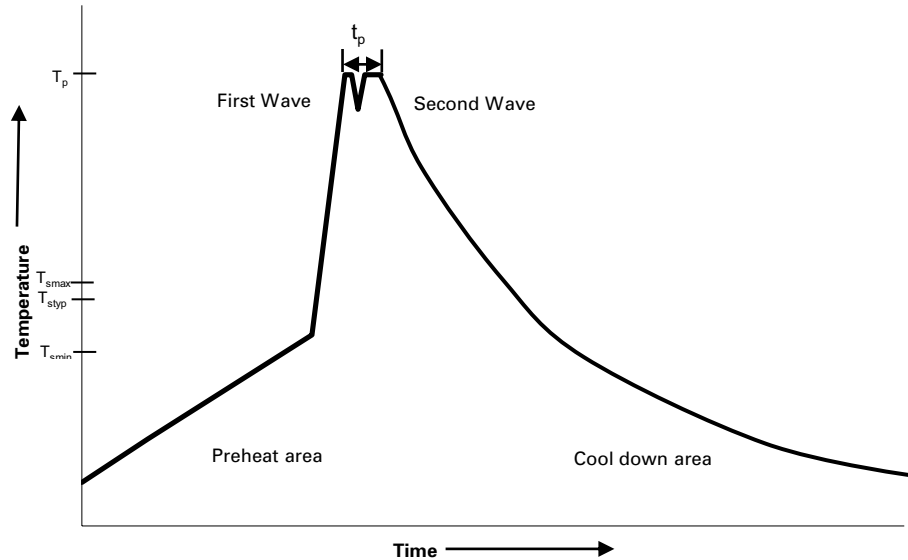

Reference EN 61760-1:2006

Profile feature	Standard SnPb solder	Lead (Pb) free solder
Preheat		
• Temperature min. (T_{smin})	100 °C	100 °C
• Temperature typ. (T_{styp})	120 °C	120 °C
• Temperature max. (T_{smax})	130 °C	130 °C
• Time (T_{smin} to T_{smax}) (t_s)	70 seconds	70 seconds
Δ preheat to max Temperature	150 °C max.	150 °C max.
Peak temperature (T_p)*	235 °C – 260 °C	250 °C – 260 °C
Time at peak temperature (t_p)	10 seconds max 5 seconds max each wave	10 seconds max 5 seconds max each wave
Ramp-down rate	~ 2 K/s min ~3.5 K/s typ ~5 K/s max	~ 2 K/s min ~3.5 K/s typ ~5 K/s max
Time 25 °C to 25 °C	4 minutes	4 minutes

Manual solder

+350 °C (4-5 seconds by soldering iron), generally manual/hand soldering is not recommended

Life Support Policy: Eaton does not authorize the use of any of its products for use in life support devices or systems without the express written approval of an officer of the Company. Life support systems are devices which support or sustain life, and whose failure to perform, when properly used in accordance with instructions for use provided in the labeling, can be reasonably expected to result in significant injury to the user.

Eaton reserves the right, without notice, to change design or construction of any products and to discontinue or limit distribution of any products. Eaton also reserves the right to change or update, without notice, any technical information contained in this bulletin.

Eaton
Electronics Division
1000 Eaton Boulevard
Cleveland, OH 44122
United States
Eaton.com/electronics

© 2021 Eaton
All Rights Reserved
Printed in USA
Publication No. 4416 PCN19017M
January 2021

Eaton is a registered trademark.

All other trademarks are property of their respective owners.

Follow us on social media to get the latest product and support information.



Looking for pricing, stock, or lifecycle information?

Click below to explore more details on WIN SOURCE:

 [View SS-5H-1A-APH on WIN SOURCE](#)

 [Eaton Bussmann Information](#)

Optimize Your Supply Chain with WIN SOURCE Solutions

-  Global Sourcing Solution
-  Obsolete Management
-  Cost Control Management
-  Shortage Management
-  Alternative Solution
-  Excess Inventory Management