

0.4mm Pitch

SERIES

6824

0.4mmピッチ Non-ZIF(LIF) RA SMT 両面接点

0.4mmPitch Non-ZIF(LIF) RA SMT Dual-sided contact

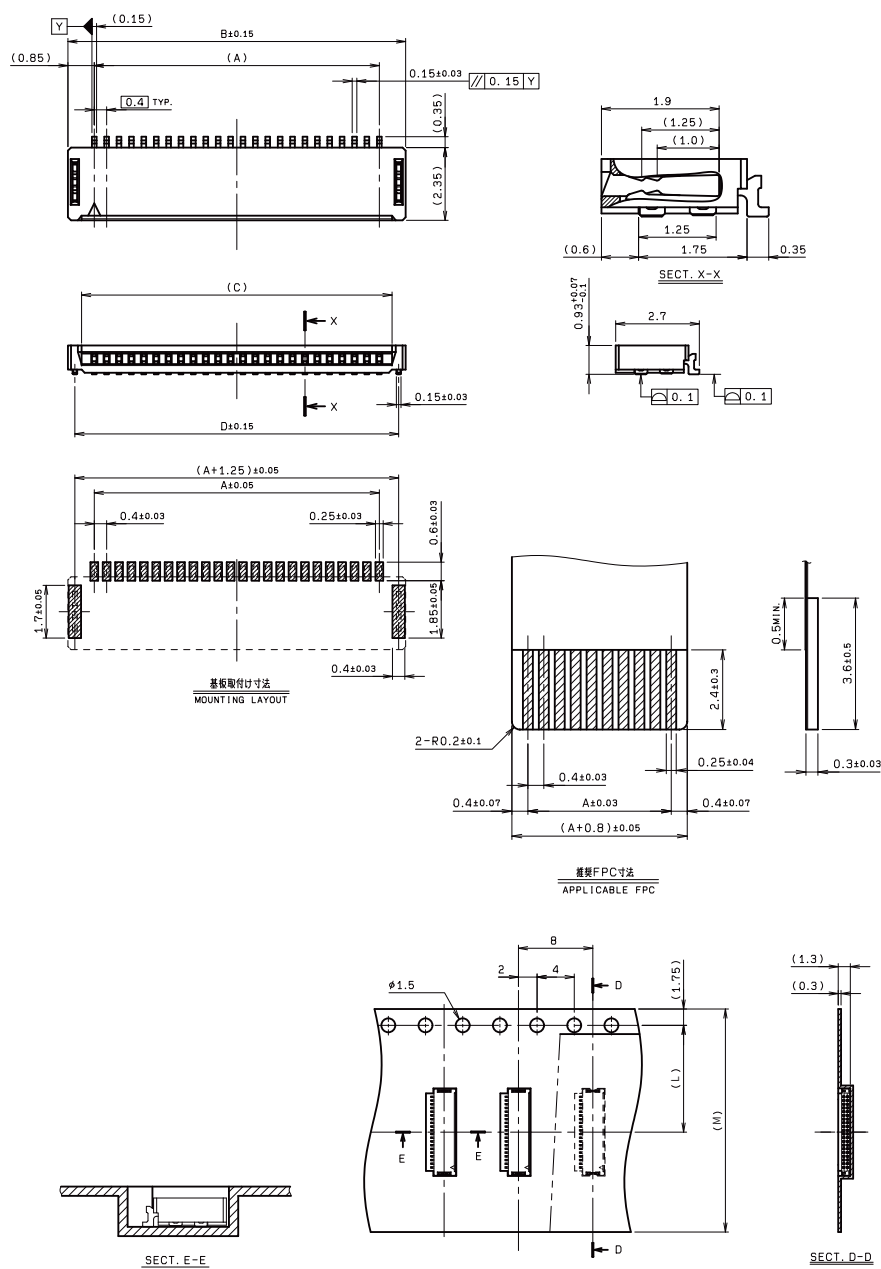

種数 NO. OF POS.	A	B	C	D
4	1.2	2.9	2.0	2.45
5	1.6	3.3	2.4	2.85
6	2.0	3.7	2.8	3.25
7	2.4	4.1	3.2	3.65
8	2.8	4.5	3.6	4.05
9	3.2	4.9	4.0	4.45
10	3.6	5.3	4.4	4.85
11	4.0	5.7	4.8	5.25
12	4.4	6.1	5.2	5.65
13	4.8	6.5	5.6	6.05
14	5.2	6.9	6.0	6.45
15	5.6	7.3	6.4	6.85
16	6.0	7.7	6.8	7.25
17	6.4	8.1	7.2	7.65
18	6.8	8.5	7.6	8.05
19	7.2	8.9	8.0	8.45
20	7.6	9.3	8.4	8.85
22	8.4	10.1	9.2	9.65

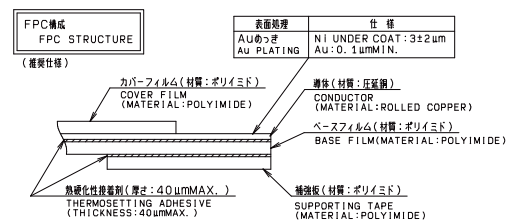

極数 NO. OF POS.	L	M
4	7.5	16.0
5	7.5	16.0
6	7.5	16.0
7	7.5	16.0
8	7.5	16.0
9	7.5	16.0
10	7.5	16.0
11	7.5	16.0
12	7.5	16.0
13	7.5	16.0
14	7.5	16.0
15	7.5	16.0
16	11.5	24.0
17	11.5	24.0
18	11.5	24.0
19	11.5	24.0
20	11.5	24.0
22	11.5	24.0

注文コード ORDERING CODE
04 6824 6XX 000 846 +

RoHS 対応品
RoHS Compliant Product

極数 NUMBER OF POSITIONS

生産対応可能極数については、営業部に
ご確認ください。

Feel free to contact our sales department
for available numbers of positions.







梱包数量 6000個/リール
PACKING QUANTITY : 6000/Reel

Looking for pricing, stock, or lifecycle information?

Click below to explore more details on WIN SOURCE:

-  [View 046824604000846+ on WIN SOURCE](#)
-  [AVX Corp/Kyocera Corp](#) Information

Optimize Your Supply Chain with WIN SOURCE Solutions

-  Global Sourcing Solution
-  Obsolete Management
-  Cost Control Management
-  Shortage Management
-  Alternative Solution
-  Excess Inventory Management