

0.5mm Pitch

SERIES

6806

0.5mmピッチ RA SMT 下接点

0.5mmPitch RA SMT Bottom contact

高速伝送対応
For High-speed Transmission

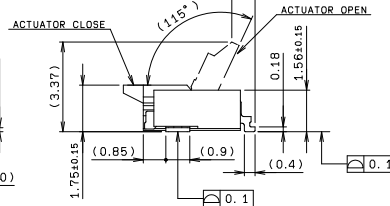
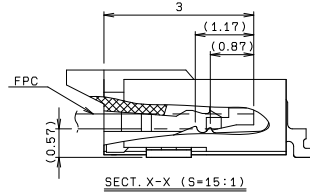
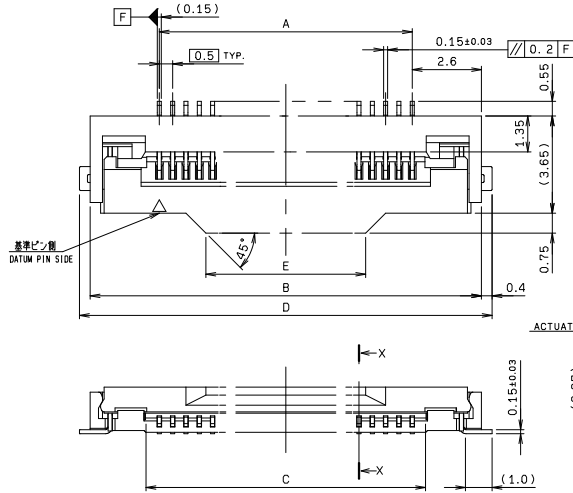

極数 NO. OF POS.	A	B	C	D	E
8	3.5	8.7	4.55	9.5	2.85
10	4.5	9.7	5.55	10.5	3.85
12	5.5	10.7	6.55	11.5	4.85
14	6.5	11.7	7.55	12.5	5.85
20	9.5	14.7	10.55	15.5	6.0
21	10.0	15.2	11.05	16.0	6.5
26	12.5	17.7	13.55	18.5	9.0
30	14.5	19.7	15.55	20.5	11.0
35	17.0	22.2	18.05	23.0	13.5
40	19.5	24.7	20.55	25.5	16.0
45	22.0	27.2	23.05	28.0	18.5
50	24.5	29.7	25.55	30.5	21.0
60	29.5	34.7	30.55	35.5	26.0
68	33.5	38.7	34.55	39.5	30.0
70	34.5	39.7	35.55	40.5	31.0
74	36.5	41.7	37.55	42.5	33.0
80	39.5	44.7	40.55	45.5	36.0

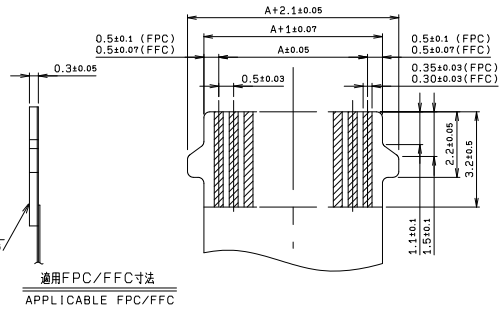
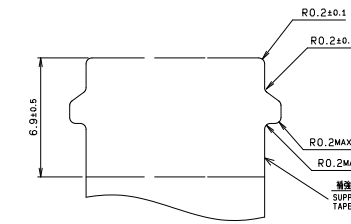
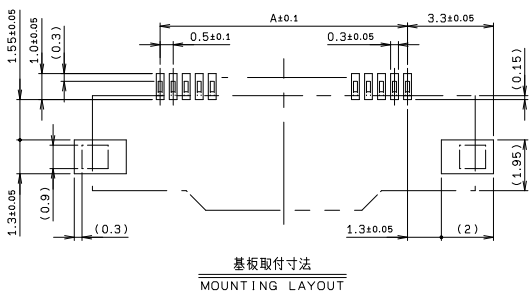

● Packaging

8 to 20 Pin

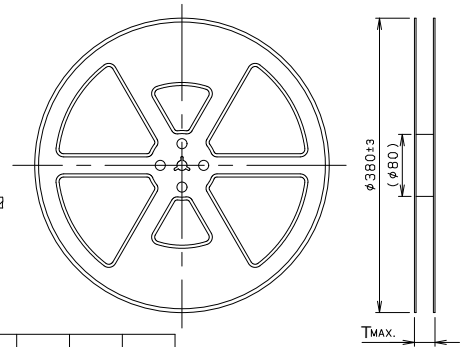
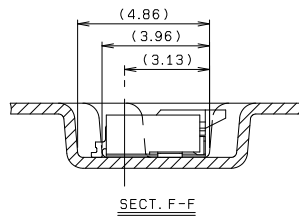
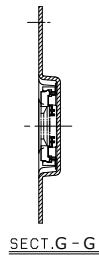
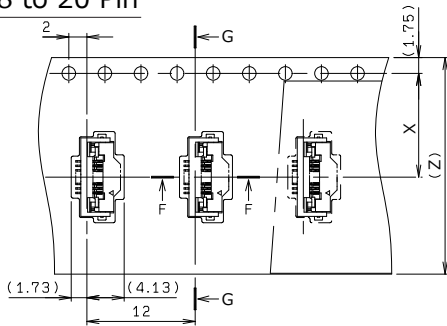

21 to 80 Pin

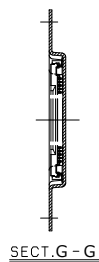
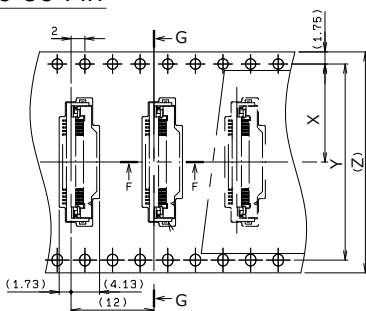

極数 NO. OF POS.	X	Y	Z	T
8	11.5	—	24.0	30.4
10	11.5	—	24.0	30.4
12	11.5	—	24.0	30.4
14	11.5	—	24.0	30.4
20	11.5	—	24.0	30.4
21	14.2	28.4	32.0	38.4
26	14.2	28.4	32.0	38.4
30	14.2	28.4	32.0	38.4
35	20.2	38.5	44.0	50.4
40	20.2	38.5	44.0	50.4
45	20.2	38.5	44.0	50.4
50	20.2	38.5	44.0	50.4
60	26.2	50.5	56.0	62.4
68	26.2	50.5	56.0	62.4
70	26.2	50.5	56.0	62.4
74	26.2	50.5	56.0	62.4
80	26.2	50.5	56.0	62.4

注文コード ORDERING CODE
04 6806 0XX 100 846+

極数
NUMBER OF POSITIONS

RoHS 対応品
RoHS Compliant Product

生産対応可能極数については、営業部にご確認願います。
Feel free to contact our sales department for available numbers of positions.
梱包数量 3000個/リール
PACKING QUANTITY : 3000/Reel

Looking for pricing, stock, or lifecycle information?

Click below to explore more details on WIN SOURCE:

- [View 046806020000846+ on WIN SOURCE](#)
- [AVX Corp/Kyocera Corp Information](#)

Optimize Your Supply Chain with WIN SOURCE Solutions

- ✓ Global Sourcing Solution
- ✓ Obsolete Management
- ✓ Cost Control Management
- ✓ Shortage Management
- ✓ Alternative Solution
- ✓ Excess Inventory Management