



THE DATASHEET OF GT32FS-4DP-HU



Product Specifications

Ratings	Current : 1A	Voltage : 30V AC
	Operating temperature range : -40°C to +105°C	Storage temperature range : -40°C to +105°C

Items	Specifications	Conditions
1. Contact resistance	Signal : 30mΩ max, External : 60mΩ max	Measured at 1A DC.
2. Insulation resistance	100MΩ min	Measured at 500V DC.
3. Withstanding voltage	There shall be no flashover or dielectric breakdown.	Apply 500V AC for one minute.
4. Vibration resistance	① There shall be no electrical discontinuity lasting for a minimum of 10μs. ② Contact resistance : Signal : 60mΩ max External : 120mΩ max ③ There shall be no damage, cracks or loosened parts.	Frequency : 20 to 200Hz, acceleration : 43.1m/s ² , 3 directions, 3 cycles each.
5. Humidity resistance in steady state	① Contact resistance : Signal : 60mΩ max External : 120mΩ max ② Insulation resistance : 100MΩ min ③ There shall be no damage, cracks or loosened parts.	Temperature : 60°C, relative humidity : 90 to 95%, leave 500 hours.
6. Thermal shock	① Contact resistance : Signal : 60mΩ max External : 120mΩ max ② Insulation resistance : 100MΩ min ③ There shall be no damage, cracks or loosened parts.	Temperature -40 → Room temperature → 85°C → Room temperature Time : 30 → 5 → 30 → 5 minutes 1000 cycles.
7. Repeated action	① Contact resistance : Signal : 60mΩ max External : 120mΩ max ② There shall be no damage, cracks or loosened parts.	30 mating cycles.

Product Number Structure

Refer to the chart below when determining the product specifications from the product number.
Please select from the product numbers listed in this catalog when placing orders.

●Female connector crimp contact, Male connector crimp contact

GT 32 – 2428 SCF

① ② ③ ④

① Series Name	GT	③ Applicable wire size	2428 : 24 to 28AWG
② Series No.	32 (used for Female connector crimp contact) 32A (used for Male connector crimp contact)	④ Form/Packaging /Packaging type	SCF : Female connector crimp contact/reel packaging products PCF : Male connector crimp contact/reel packaging products

●Female connector insulation case, Male connector insulation case

GT 32F – 4 D S – 1.5 C

① ② ③ ④ ⑤ ⑥ ⑦

① Series Name	GT	⑤ Connector type	S : Female connector P : Male connector
② Series No.	32F	⑥ Contact pitch	1.5 : 1.5mm pitch
③ Number of contacts	4	⑦ Part type	C : Insulation case
④ Number of columns	D : 2 columns		

●Female connector shell, Male connector shell

●Female connector shield cover, Male connector shield cover

●Female connector housing, Male connector housing

GT 32F S – 4 D S – 5CF

① ② ③ ④ ⑤ ⑥ ⑦

① Series Name	GT	⑤ Number of columns	D : 2 rows
② Series No.	32F	⑥ Connector type	S : Female connector P : Male connector
③ Shape	S : Straight	⑦ Part type	5CF : φ4.6 to 5.0 sheath crimp contact SC : Shield cover HU : Housing
④ Number of contacts	4		

Product configurations

Female connector

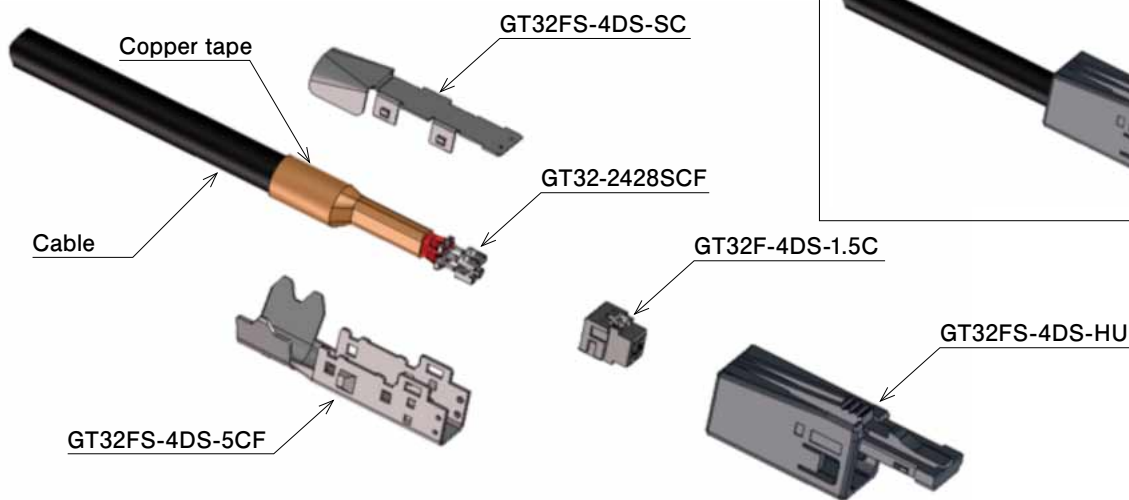

Female connector (complete)



Male connector

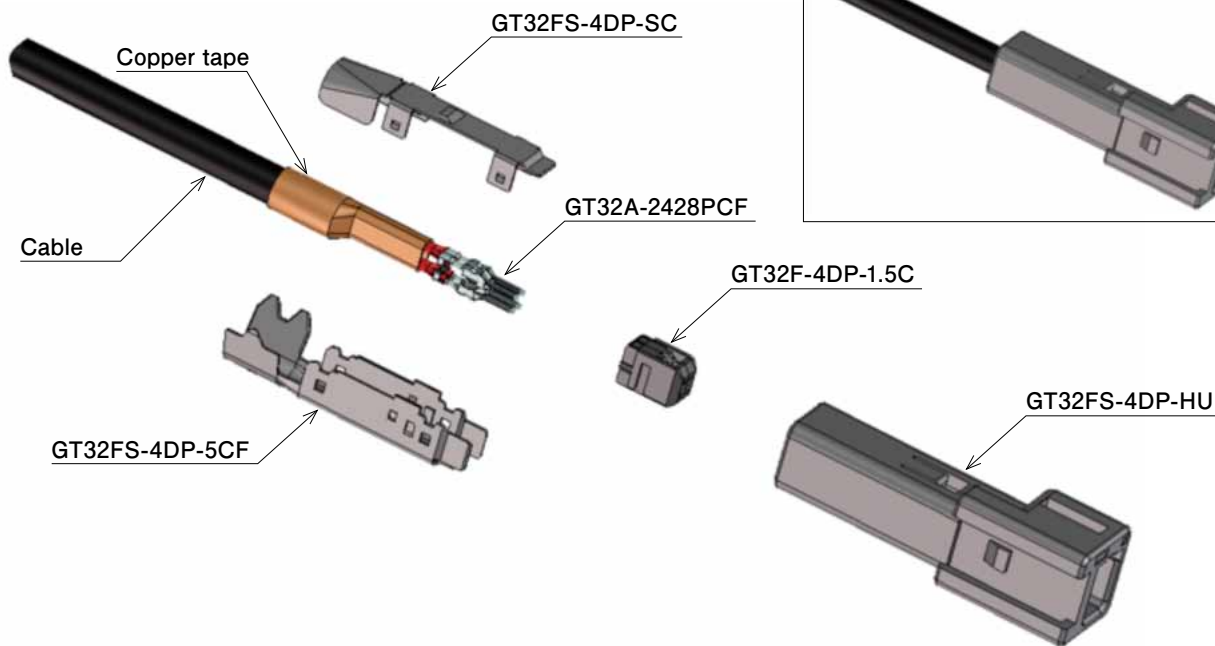

Male connector (complete)

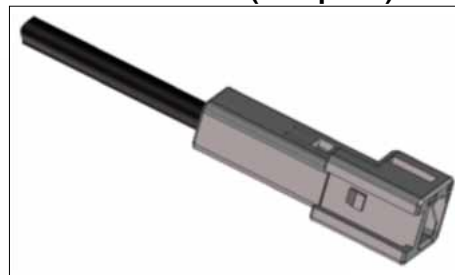

GT32 Series Mating table

Female connector		Male connector	
GT32F 4 cores Straight plug connector	Configuration product name	GT32F 4 cores In-line connector	Configuration product name
	GT32-2428SCF		GT32A-2428PCF
	GT32F-4DS-1.5C		GT32F-4DP-1.5C
	GT32FS-4DS-5CF		GT32FS-4DP-5CF
	GT32FS-4DS-SC		GT32FS-4DP-SC
	GT32FS-4DS-HU		GT32FS-4DP-HU

■ 4-core straight plug connector (Female connector)

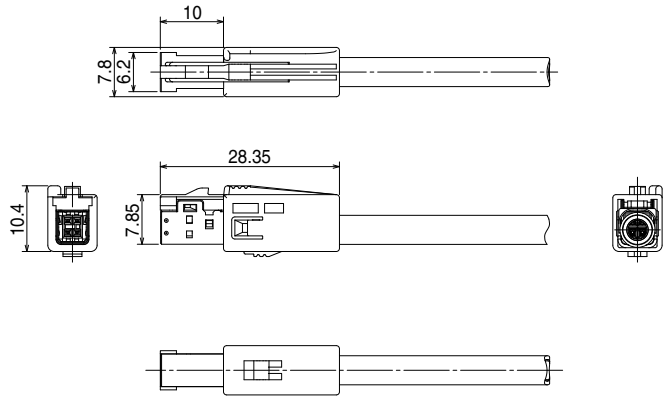

This product includes the following parts.

Crimp contact

Part No.	GT32-2428SCF
HRS No.	782-0007-8 00
Core cable size	24 to 28AWG
Material/finish, color	Copper alloy
Sales unit	10,000 pcs/reel
RoHS	○

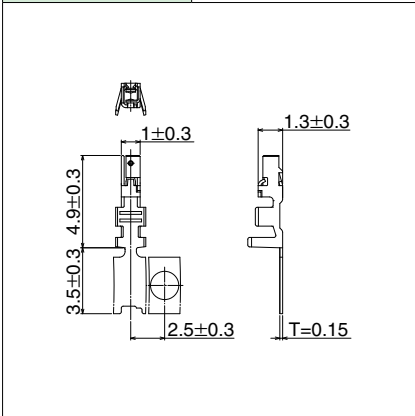

Insulation case

Part No.	GT32F-4DS-1.5C
HRS No.	782-0051-0 00
Material/finish, color	PBT/light gray
Sales unit	1 piece
RoHS	○

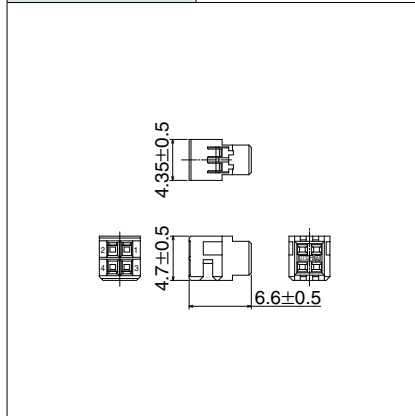

Shell

Part No.	GT32FS-4DS-5CF
HRS No.	782-0052-2 00
Cable size	φ4.6~5.0mm
Material/finish, color	Copper alloy, tin plating
Sales unit	1 piece
RoHS	○

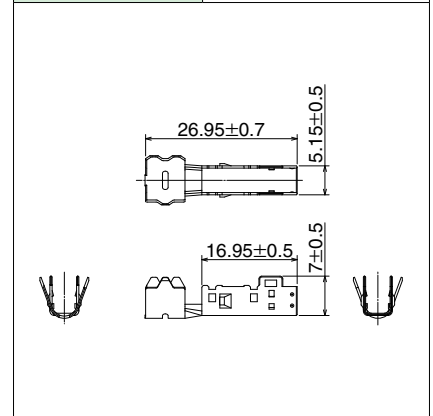

Shield cover

Part No.	GT32FS-4DS-SC
HRS No.	782-0053-5 00
Material/finish, color	Copper alloy, tin plating
Sales unit	1 piece
RoHS	○

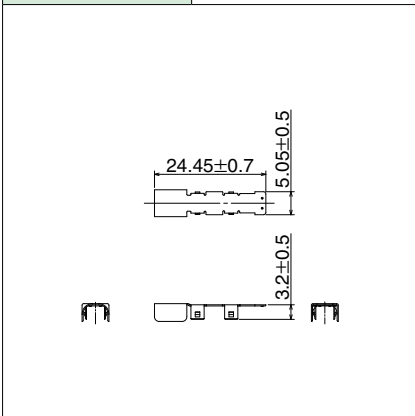

Housing

Part No.	GT32FS-4DS-HU
HRS No.	782-0054-8 00
Material/finish, color	PBT/dark gray
Sales unit	1 piece
RoHS	○

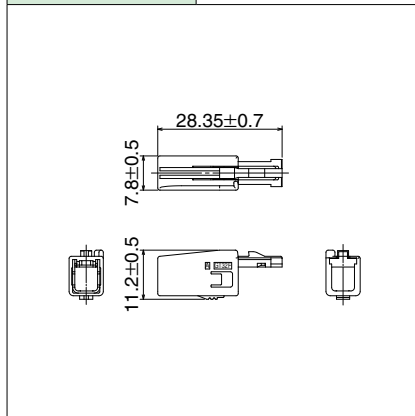

■ 4-core In-line connector (Male connector)

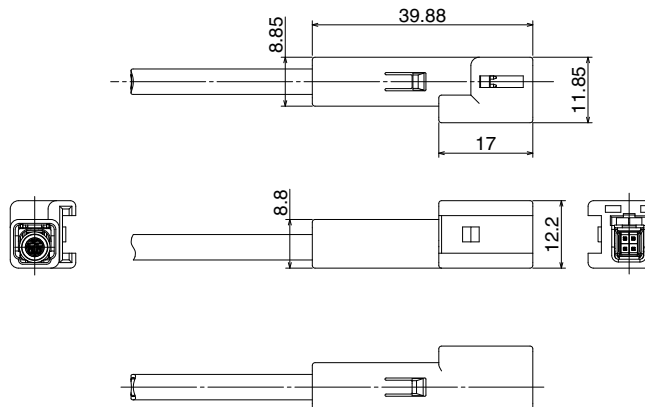

This product includes the following parts.

Crimp contact

Part No.	GT32A-2428PCF
HRS No.	782-0050-7 00
Core cable size	24 to 28AWG
Material/finish, color	Copper alloy
Sales unit	10,000 pcs/reel
RoHS	○

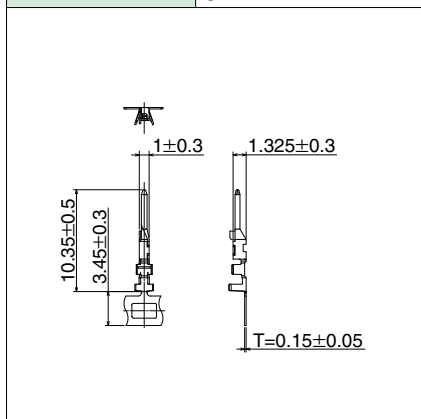

Insulation case

Part No.	GT32F-4DP-1.5C
HRS No.	782-0046-0 00
Material/finish, color	PBT/light gray
Sales unit	1 piece
RoHS	○

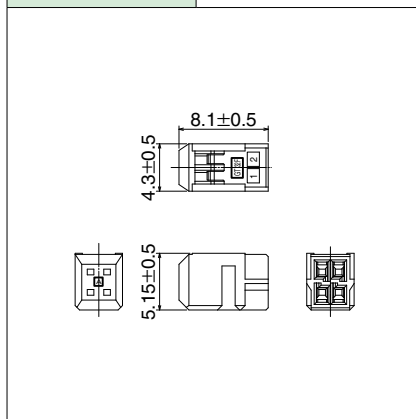

Shell

Part No.	GT32FS-4DP-5CF
HRS No.	782-0047-2 00
Cable size	φ4.6~5.0mm
Material/finish, color	Copper alloy, tin plating
Sales unit	1 piece
RoHS	○

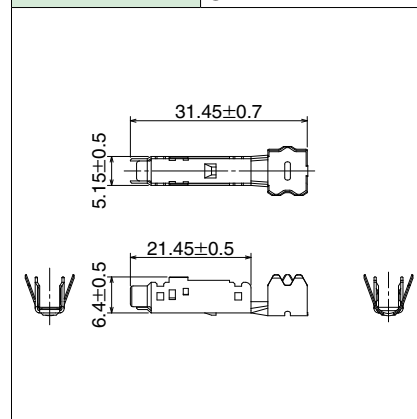

Shield cover

Part No.	GT32FS-4DP-SC
HRS No.	782-0048-5 00
Material/finish, color	Copper alloy, tin plating
Sales unit	1 piece
RoHS	○

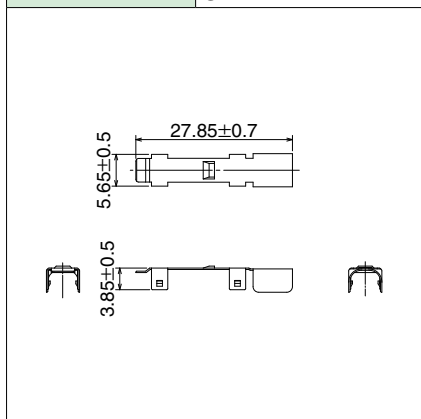

Housing

Part No.	GT32FS-4DP-HU
HRS No.	782-0049-8 00
Material/finish, color	PBT/dark gray
Sales unit	1 piece
RoHS	○

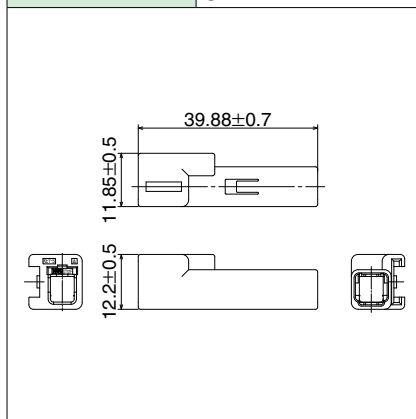

◆GT32F Series Female Connector Termination Method

- ① Strip the external sheath and wrap with copper tape.

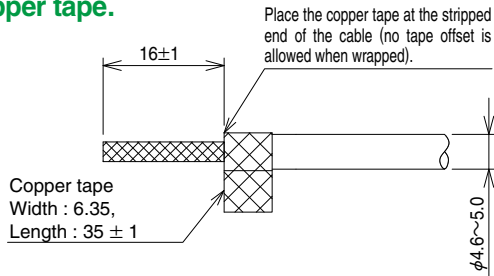

- ② Fold the shield wire.

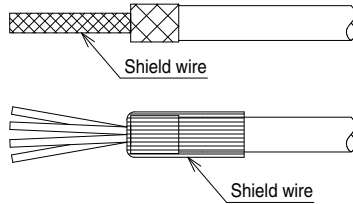

- ③ Strip the core cable to crimp a GT32-2428SCF contact.

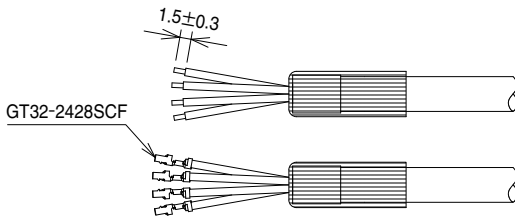

- ④ After crimped, insert the GT32-2428SCF contact into GT32F-4DS-1.5C.

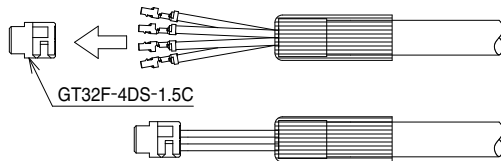

- ⑤ Wrap a piece of cloth adhesive tape onto the end of the GT32F-4DS-1.5C, and then cut the copper tape as shown below and wrap it around the cable.

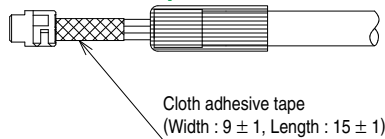

■ Shield adhesive tape cut dimension

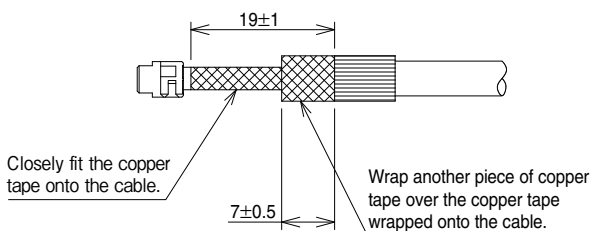

- ⑥ Cut an excess shield wire from the copper tape, and then insert the cable into GT32FS-4DS-5CF.

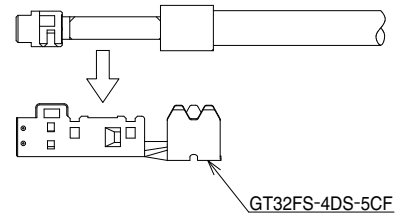

- ⑦ Crimp the GT32FS-4DS-5CF, and then cover it with GT32FS-4DS-SC.

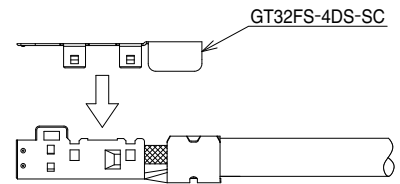

- ⑧ Assemble GT32FS-4DS-HU.

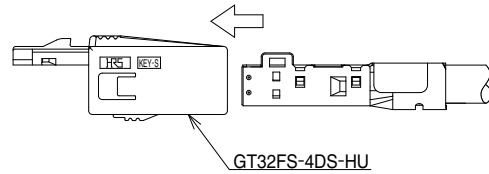

- ⑨ Completed assembly

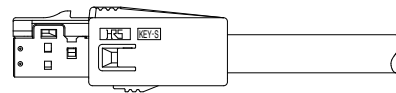

- Note 1 : The harness method may differ depending on the configuration and material of the cable.
- Note 2 : The crimp height must be set per cable. Follow the crimping condition table.

◆GT32F Series Male Connector Termination Method

① Strip the external sheath and wrap with copper tape.

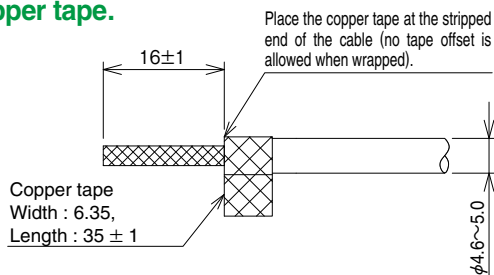

② Fold the shield wire.

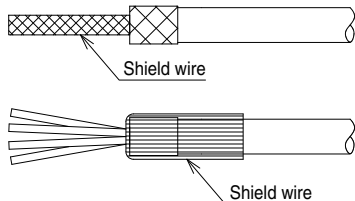

③ Strip the core cable to crimp a GT32A-2428PCF contact.

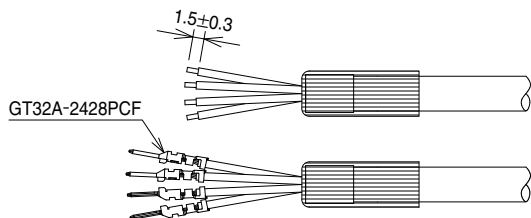

④ After crimped, insert the GT32A-2428PCF contact into GT32F-4DP-1.5C.

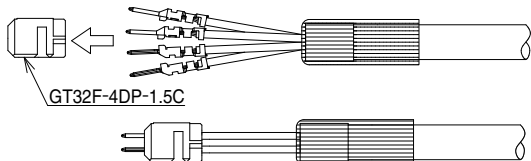

⑤ Wrap a piece of cloth adhesive tape onto the end of the GT32F-4DP-1.5C, and then cut the copper tape as shown below and wrap it around the cable.

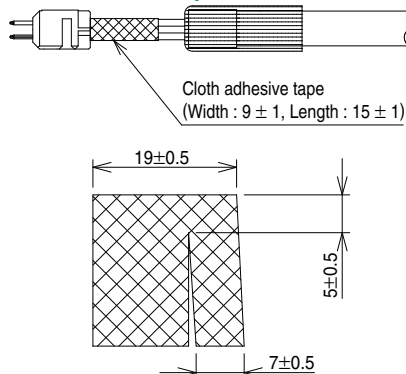

■Copper tape cut dimension

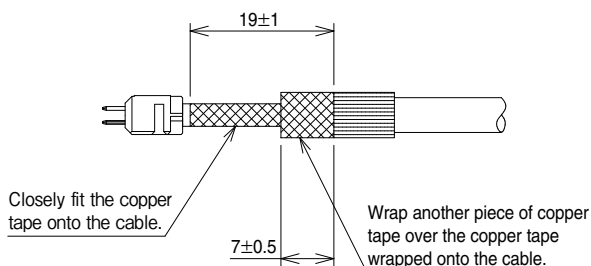

⑥ Cut an excess shield wire from the copper tape, and then insert the cable into GT32FS-4DP-5CF.

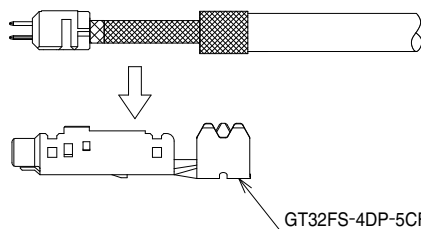

⑦ Crimp the GT32FS-4DP-5CF, and then cover it with GT32FS-4DP-SC.

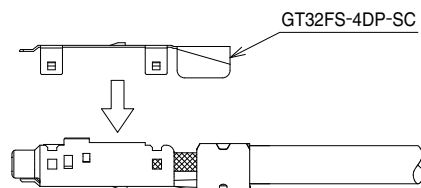

⑧ Assemble GT32FS-4DP-HU.

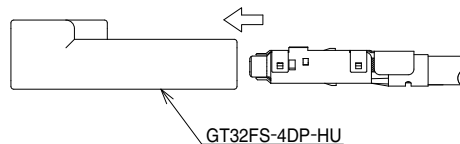

⑨ Completed assembly



Note 1 : The harness method may differ depending on the configuration and material of the cable.
 Note 2 : The crimp height must be set per cable. Follow the crimping condition table.

◆Crimping tools

User manuals are available. Please ask your Hirose Electric account representative.

●Automatic Crimping Machine



Specifications

Item	Specification	Remarks
Press capacity	1.5Ton	
Stroke	30mm	
Number of strokes	200spm (50Hz)	240spm (60Hz)
Weight	75kg	
Motor	0.2kw	AC 100V
Crimping speed	2000 to 4000 pcs. per hour	

Part No. CM-105C

Note : Please refer to the table below for applicator product numbers.

●Applicator (for use with the automatic crimping machine)

Terminal Part No.	Terminal HRS No.	Tool Part No.	Tool HRS No.
GT32-2428SCF	782-0007-8 00	AP105-GT32-2428S	901-5223-2 00
GT32A-2428PCF	782-0050-7 00	Under development	Under development

Note 1 : Crimp heights may differ depending on the cable specification, so please consult a HRS representative for assistance.

Note 2 : Before purchasing Hirose tooling, please make sure that your selected cable will work with the Hirose applicator.

Note 3 : Cables that are different from those specified by Hirose may not be suitable and may require modification to the applicator to obtain a proper crimp.

●Hand press



Part No. HOS-7

●Crimp tool for outer shield (Module for HOS-7)

Terminal Part No.	Terminal HRS No.	Tool Part No.	Tool HRS No.
GT32FS-4DS-5CF	782-0052-2 00	Under development	Under development
GT32FS-4DP-5CF	782-0047-2 00	Under development	Under development

Note 1 : (01) is set unit (HOS-7 and Crimp tool).

Note 2 : Crimp height sets for each cable. Please ask HRS sales in detail. Take time to define new crimp height.

Note 3 : Please ask Crimp height for your cable when you use HRS tool.

Note 4 : Applicable tool may be changed by specic cable.



HIROSE ELECTRIC CO.,LTD.

2-6-3,Nakagawa Chuoh,Tsuzuki-Ku,Yokohama-Shi 224-8540,JAPAN
 TEL: +81-45-620-3526 Fax: +81-45-591-3726
<http://www.hirose.com>
<http://www.hirose-connectors.com>

Looking for pricing, stock, or lifecycle information?

Click below to explore more details on WIN SOURCE:

-  [View GT32FS-4DP-HU on WIN SOURCE](#)
-  [Hirose Electric Co Ltd Information](#)

Optimize Your Supply Chain with WIN SOURCE Solutions

-  Global Sourcing Solution
-  Obsolete Management
-  Cost Control Management
-  Shortage Management
-  Alternative Solution
-  Excess Inventory Management