

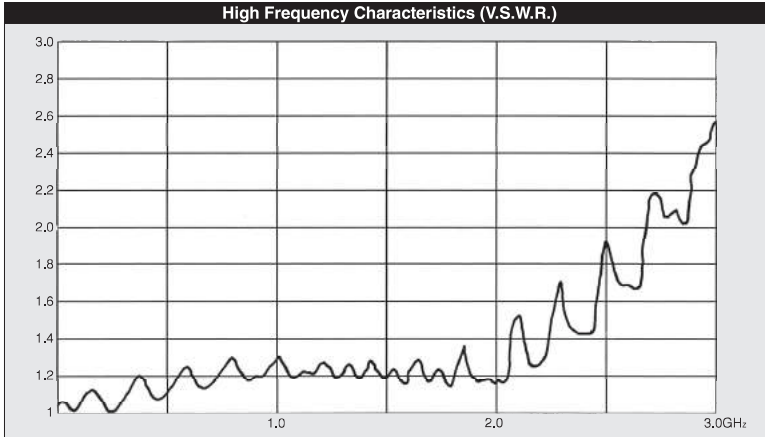

**THE DATASHEET OF
GT5-2S-HU**



◆ TEST DATA (using 1.5D-2V Type cable)



(Note) The above measurement data is for GT5-1S-HU and GT5-1PP-HU.

◆ Cable Assembly Instructions

1. Strip the cable.

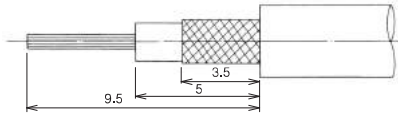

3. Insert the terminal into the housing. (Push it in until the housing lance latches.)

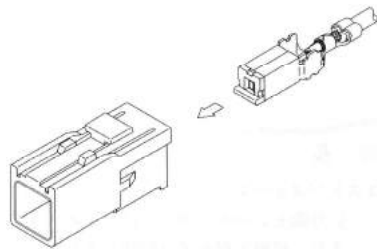

2. Crimp the cable to the terminal.

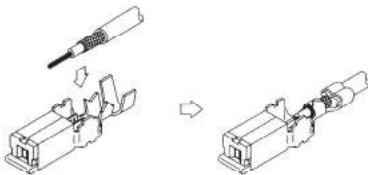

4. Attach the retainer (Push in the retainer until it locks.)

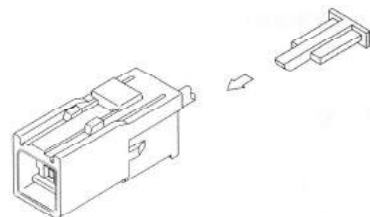

Terminal for Coaxial Cable

F Connector Terminals

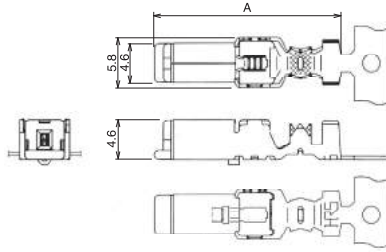

Part No.	HRS No.	Material / Finish or color	Conductor size	Insulator outer diameter	Jacket outer diameter	A	Sales unit	RoHS
GT5-30/0.7-1.5SCF(70)	755-0065-1 70	Insulator : PBT/Dark gray Center terminal : Phosphor bronze/Tin plating Outer terminal : Brass/Tin plating	AWG#30	φ0.6~0.9	φ1.4~1.8	22.7	1,300pcs/reel	○
GT5-2428/1.1-2.2SCF	755-0123-6		AWG#24~28	φ1.0~1.4	φ2.0~2.4	21.7		
GT5-2428/1.6-2.5SCF(70)	755-0078-3 70		AWG#30	φ1.5~2.0	φ2.3~2.7			
GT5-30/1.6-2.9SCF(70)	755-0022-9 70		AWG#24~28	φ2.0~2.5	φ3.3~3.7	22.7		
GT5-2428/1.6-2.9SCF(70)	755-0002-1 70		AWG#30	φ2.5~2.9	φ3.6~4.0			
GT5-2022/1.6-2.9SCF(70)	755-0071-4 70		AWG#20~22	φ2.5~2.9	φ4.6~5.0	22.7		
GT5-2022/F2.7-3.5SCF(70)	755-0077-0 70		AWG#24~28					
GT5-2022/F3.3-4.8SCF(70)	755-0054-5 70		AWG#30	φ3.0~3.6	AWG#20~22	1,100pcs/reel		
GT5-30/F3.3-5SCF(70)	755-0016-6 70		AWG#24~28					
GT5-2428/F3.3-5SCF(70)	755-0012-5 70		AWG#20~22	φ3.0~3.6	AWG#20~22	1,100pcs/reel		
GT5-2022/F3.3-5SCF(70)	755-0034-8 70	AWG#30						
GT5-30/F4-5SCF(70)	755-0020-3 70	AWG#24~28	φ3.0~3.6	AWG#20~22	1,100pcs/reel			
GT5-2428/F4-5SCF(70)	755-0024-4 70	AWG#20~22						
GT5-2022/F4-5SCF(70)	755-0036-3 70	AWG#20~22						

Note : Products marked with an asterisk (*) support insulators made of polyethylene foam.

M Connector Terminals

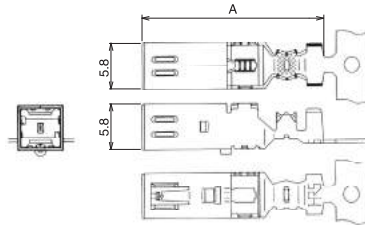

Part No.	HRS No.	Material / Finish or color	Conductor size	Insulator outer diameter	Jacket outer diameter	A	Sales unit	RoHS
GT5-30/0.7-1.5PCF(70)	755-0017-9 70	Insulator : PBT/Dark gray Center terminal : Brass/Tin plating Outer terminal : Brass/Tin plating	AWG#30	φ0.6~0.9	φ1.4~1.8	24.05	900pcs/reel	○
GT5-30/1.6-2.9PCF(70)	755-0021-6 70		AWG#24~28	φ1.5~2.0	φ2.6~3.4	23.05		
GT5-2428/1.6-2.9PCF(70)	755-0001-9 70		AWG#20~22	φ2.0~2.5	φ3.3~3.7			
GT5-2022/1.6-2.9PCF(70)	755-0094-0 70		AWG#30	φ2.5~2.9	φ3.6~4.0	24.05		
GT5-2022/F2.7-3.5PCF(70)	755-0076-8 70		AWG#24~28	φ2.5~2.9	φ4.6~5.0			
GT5-2022/F3.3-4.8PCF(70)	755-0053-2 70		AWG#30					
GT5-30/F3.3-5PCF(70)	755-0015-3 70		AWG#24~28	φ3.0~3.6	AWG#20~22	24.05		
GT5-2428/F3.3-5PCF(70)	755-0011-2 70		AWG#20~22					
GT5-2022/F3.3-5PCF(70)	755-0033-5 70		AWG#30	φ3.0~3.6	AWG#24~28	24.05		
GT5-30/F4-5PCF(70)	755-0019-4 70		AWG#20~22					
GT5-2428/F4-5PCF(70)	755-0023-1 70	AWG#24~28	φ3.0~3.6	AWG#20~22	24.05			
GT5-2022/F4-5PCF(70)	755-0035-0 70	AWG#20~22						

Note : Products marked with an asterisk (*) support insulators made of polyethylene foam.

Terminal for Low-insertion M Connector

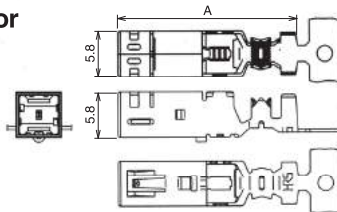

Part No.	HRS No.	Material / Finish or color	Conductor size	Insulator outer diameter	Jacket outer diameter	A	Sales unit	RoHS
GT5L30/0.7-1.5PCF(70)	755-0068-0 70	Insulator : PBT/Dark gray Center terminal : Brass/Tin plating Outer terminal : Brass/Tin plating	AWG#30	φ0.6~0.9	φ1.4~1.8	24.05	900pcs/reel	○
GT5L2428/1.6-2.5PCF(70)	755-0079-6 70		AWG#24~28	φ1.5~2.0	φ2.3~2.7	23.05		
GT5L30/1.6-2.9PCF(70)	755-0067-7 70		AWG#30	φ2.6~3.4	AWG#24~28			
GT5L2428/1.6-2.9PCF(70)	755-0066-4 70		AWG#24~28					

GT5
GT13
GT16
GT19
GT21
GT36
GT43
GT17
GT32
GT25
KM37
ZE05
ZG05J2
HM-200
ZE64W
T307U
FK26
DE40
DE40GL
FH28K
FH2K
FH65
FH40
FH63S
FH67

1 Pos. for Coaxial Cable

F Connector

● **Housing**



GT5-1S-HU

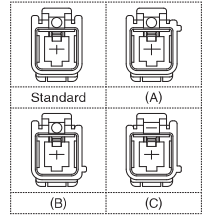
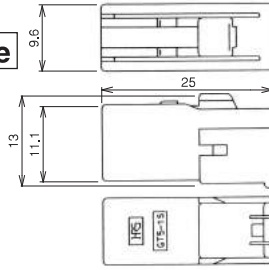

◆ **Shown with retainer inserted.**

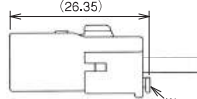

*Use together with separate retainer (GT5-1P/S-R) sold separately.

Part No.	HRS No.	Material	Color	Key position	Corresponding M Connector Housing	Corresponding M Connector Board-Mounting	Sales unit	RoHS
GT5-1S-HU	755-0004-7	PBT	Light gray	Standard	GT5-1PP-HU(70)	GT5-1P-DS(70)	1	○
GT5-1S-HU(A)	755-0037-6		Brown	(A)	GT5-1PP-HU(A)(70)	GT5-1P-DS(A)(70)		
GT5-1S-HU(B)	755-0038-9		Green	(B)	GT5-1PP-HU(B)(70)	GT5-1P-DS(B)(70)		
GT5-1S-HU(C)	755-0080-5		Blue	(C)	GT5-1PP-HU(C)(70)	GT5-1P-DS(C)(70)		

*M connector mating table (Use types with matching key positions as described above.)

● **Retainer (Used with: GT5-1S-HU, GT5-1PP-HU, GT5N-1PP-HU, GT5H-1PP-HU)**



Part No.	HRS No.	Material	Color	Sales unit	RoHS
GT5-1P/S-R	755-0006-2	PBT	Dark gray	1	○

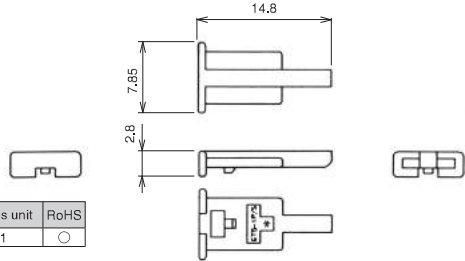

● **Housing (Retainer Not Required)**



GT5R-1S-HU

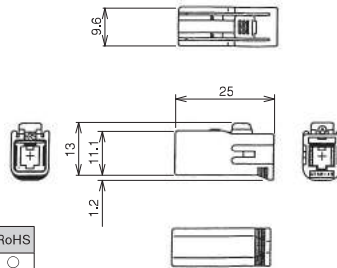

Part No.	HRS No.	Material	Color	Sales unit	RoHS
GT5R-1S-HU	755-0047-0	PBT	Light gray	1	○

Dec. 1, 2021, Copyright 2021 HIROSE ELECTRIC CO., LTD., All Rights Reserved. GT5 GT13 GT16 GT19 FH65 FH40 FH35 FH67

M Connector

● Housing

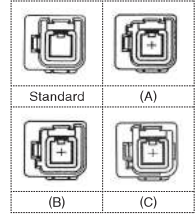
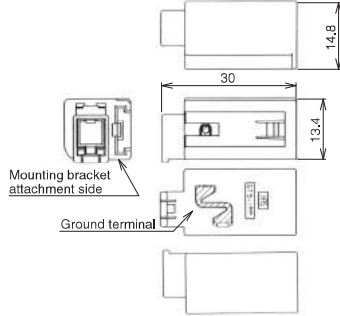

◆ Shown with retainer inserted.

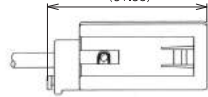

*Use together with separate retainer (GT5-1P/S-R) sold separately.

Part No.	HRS No.	Corresponding F Connector Housing	Material / Finish	Color	Key position	Sales unit	RoHS
GT5-1PP-HU(70)	755-0005-0 70	GT5-1S-HU	Housing: PBT	Light gray	Standard	1	○
GT5-1PP-HU(A)(70)	755-0039-1 70	GT5-1S-HU (A)	Ground terminal: Phosphor bronze/Tin plating	Brown	(A)		
GT5-1PP-HU(B)(70)	755-0040-0 70	GT5-1S-HU (B)		Green	(B)		
GT5-1PP-HU(C)(70)	755-0103-9 70	GT5-1S-HU (C)		Blue	(C)		

*See page 17 for panel mounting in-line bracket.

*Please use a corresponding F connector housing with a matching key type.

● Housing (H type bracket)

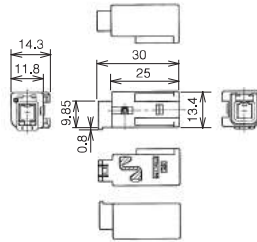

◆ Mated Connector

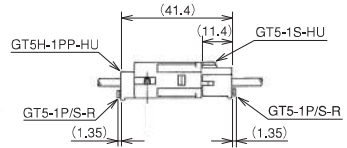

*Use together with separate retainer (GT5-1P/S-R) sold separately.

Part No.	HRS No.	Material	Color	Corresponding F Connector	Sales unit	RoHS
GT5H-1PP-HU(10)	755-0093-7 10	PBT	Light gray	GT5-1S-HU GT5R-1S-HU	1	○

● Housing (N type bracket)

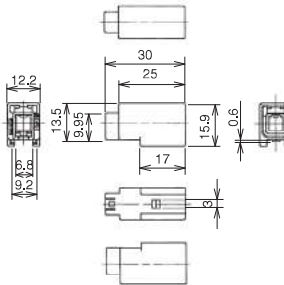
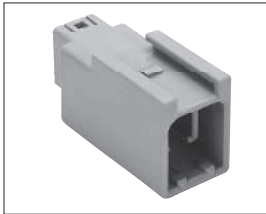

◆ Mated Connector

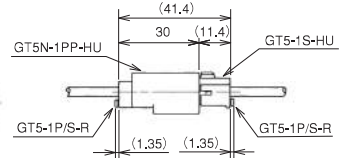

*Use together with separate retainer (GT5-1P/S-R) sold separately.

Part No.	HRS No.	Material	Color	Corresponding F Connector	Sales unit	RoHS
GT5N-1PP-HU	755-0090-9	PBT	Light gray	GT5-1S-HU GT5R-1S-HU	1	○

● Housing

〔 Panel Mount type
Enforced Shield type 〕

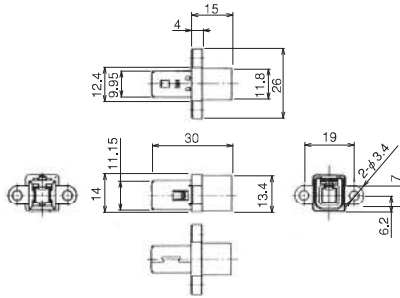

◆ Recommended Panel Dimensions

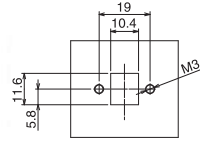

◆ Mated Connector

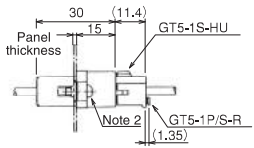

Part No.	HRS No.	Material / Finish or color	Corresponding F Connector	Sales unit	RoHS
GT5A-1PP-HU(70)	755-0025-7 70	Housing : PBT/ Light gray Ground terminal : Brass/Tin plating	GT5-1S-HU GT5R-1S-HU	1	○

Note 1 : This product does not require a retainer.

Note 2 : Use M3 screws listed in JIS B 1111 and 1101 M3 screws for mounting screws.

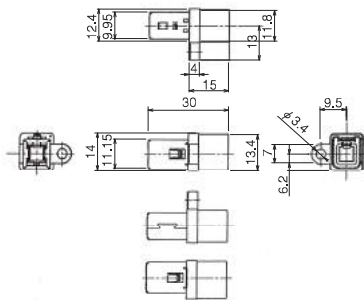

◆ Recommended Panel Dimensions

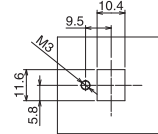

Part No.	HRS No.	Material / Finish or color	Corresponding F Connector	Sales unit	RoHS
GT5P-1PP-HU(70)	755-0030-7 70	Housing : PBT/ Light gray Ground terminal : Brass/Tin plating	GT5-1S-HU GT5R-1S-HU	1	○

Note 1 : This product does not require a retainer.

Note 2 : Use M3 screws listed in JIS B 1111 and 1101 M3 screws for mounting screws.

Dec. 1, 2021 Copyright 2021 HIROSE ELECTRIC CO., LTD., All Rights Reserved.

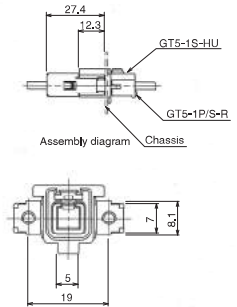
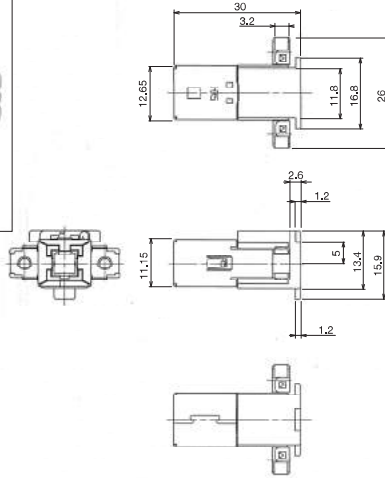
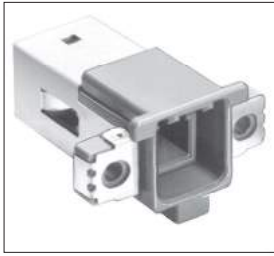

Part No.	HRS No.	Material / Finish or color	Corresponding F Connector	Sales unit	RoHS
GT5B-1PP-HU(70)	755-0051-7 70	Housing : PBT/ Light gray Ground terminal : Phosphor bronze/Tin plating	GT5-1S-HU GT5R-1S-HU	1	○

Note 1 : This product does not require a retainer.

Note 2 : Use JIS B 1115 and 1122 class 4, nominal diameter 3, length 6 screws for the mounting screws.

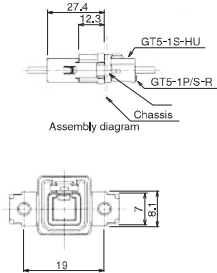
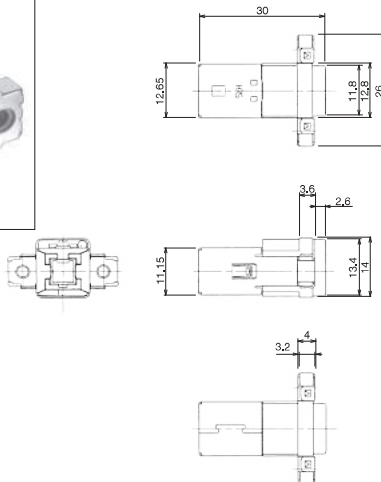

Part No.	HRS No.	Material / Finish or color	Corresponding F Connector	Sales unit	RoHS
GT5S-1PP-HU(70)	755-0050-4 70	Housing : PBT/ Light gray Ground terminal : Phosphor bronze/Tin plating	GT5-1S-HU GT5R-1S-HU	1	○

Note 1 : This product does not require a retainer.

Note 2 : Use JIS B 1115 and 1122 class 4, nominal diameter 3, length 6 screws for the mounting screws.

GT5
GT13
GT16
GT19
GT21
GT36
GT43
GT17
GT32
GT25
KM37
ZE05
Z09J2
HM-5-200
ZE64W
H207L
FX26
DE40
DE40GL
FH28K
FH2K
FH65
FH40
FH63
FH67

● Board Mount type

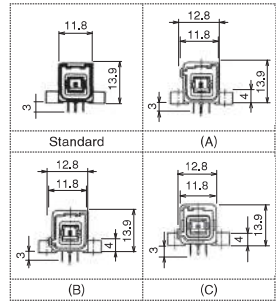
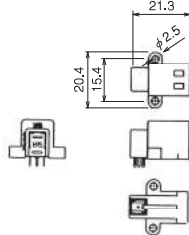

◆ Mated Connector

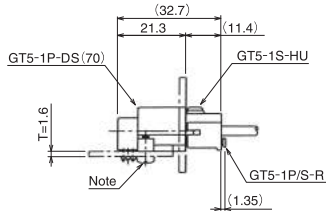

◆ Recommended Board Dimensions

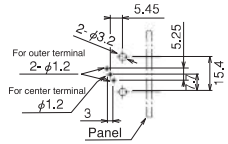

Part No.	HRS No.	Material / Finish or color	Color	Key position	Corresponding connector	Sales unit	RoHS
GT5-1P-DS(70)	755-0007-5 70	Housing: PBT	Light gray	Standard	GT5-1S-HU	1	○
GT5-1P-DS(A)(70)	755-0041-3 70	Center terminal: Brass/Tin plating	Brown	(A)	GT5-1S-HU(A)		
GT5-1P-DS(B)(70)	755-0042-6 70	Insulator: PBT/Dark gray	Green	(B)	GT5-1S-HU(B)		
GT5-1P-DS(C)(70)	755-0083-3 70	Outer terminal: Phosphor bronze/Tin plating	Blue	(C)	GT5-1S-HU(C)		

Note : Use JIS B 1115 and 1122 class 4, nominal diameter 3, length 6 screws (for a board thickness of 1.6 mm) for the mounting screws.
 *Six types of keys are available.
 Please use a corresponding F connector housing with a matching key type.

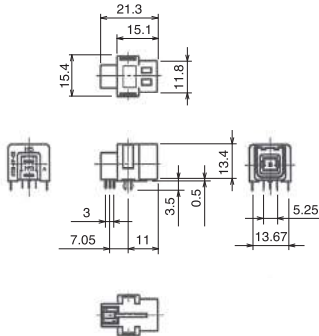

◆ Mated Connector

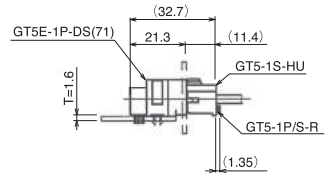

◆ Recommended Board Dimensions

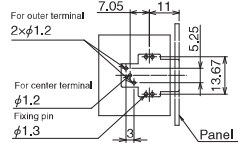

Part No.	HRS No.	Material / Finish or color	Corresponding connector	Sales unit	RoHS
GT5E-1P-DS(71)	755-0125-1 71	Housing: PA/ Natural Center terminal: Brass/Tin plating Insulator: PA/Black Outer terminal: Phosphor bronze/Tin plating Fixing pin: Brass/ Tin plating	GT5-1S-HU GT5R-1S-HU	1	○

1 Pos. for Coaxial Cable, Waterproof type

F Connector

● Housing

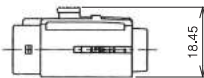
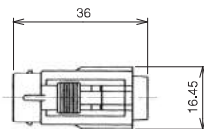

Part No.	HRS No.	Material	Color	Sales unit	RoHS
GT5W-1S-HU	755-0027-2	PBT	Light gray	1	○

Note : Use this product with a retainer that matches the cable.

● Retainer (Used with: GT5W-1PP-HU, GT5JW-1PP-HU, GT5W-1S-HU, GT5W-1P-HU)

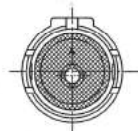
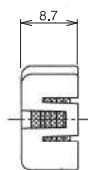
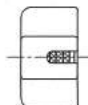
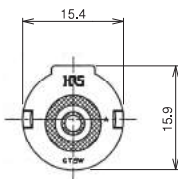

Part No.	HRS No.	Material / Finish or color	Sales unit	RoHS
GT5W-1P/S-R	755-0028-5	Retainer : PBT/Dark gray Rubber : Silicon rubber/Light blue	1	○

*This product supports cables with outer diameters of $\phi 2.9$ to $\phi 3.4$.
Waterproofness will depend on the cable. Please contact Hirose Electric if you intend to use cables other than those recommended.

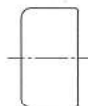

M Connector

Housing

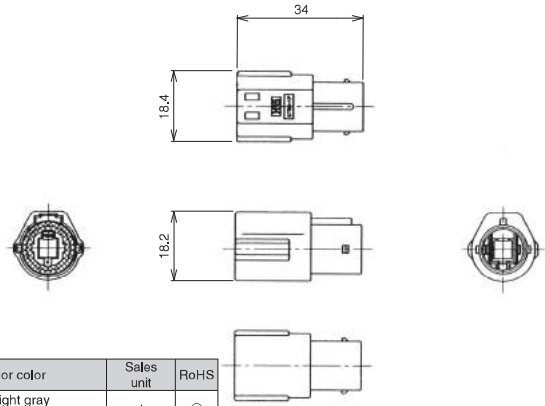

Part No.	HRS No.	Material / Finish or color	Sales unit	RoHS
GT5W-1P-HU	755-0026-0	Housing : PBT/ Light gray Connector seal : Silicon rubber/White	1	○

Note : Use this product with a retainer that matches the cable.

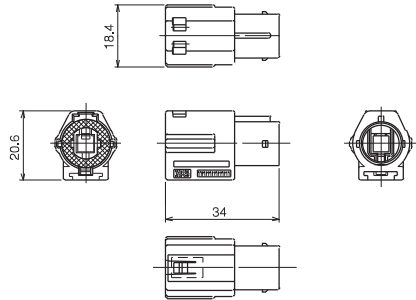

Recommended Bracket Dimensions (Used with GT5W-1PP-HU)

Please check with Hirose for information on the bracket for GT5JW-1PP-HU.

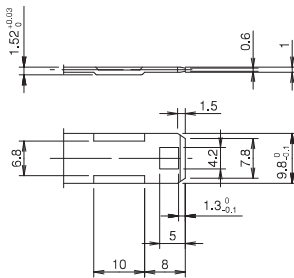

Mated Connector

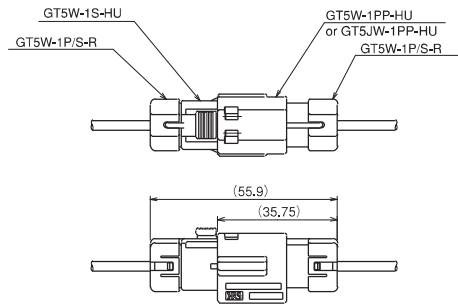

Part No.	HRS No.	Material / Finish or color	Sales unit	RoHS
GT5W-1PP-HU	755-0070-1	Housing : PBT/ Light gray Connector seal : Silicon rubber/White	1	○
GT5JW-1PP-HU	755-0069-2			

Note : Use this product with a retainer that matches the cable.

G Terminal

■ For Cable Termination Part

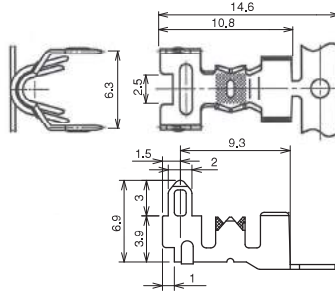
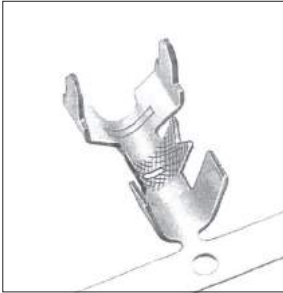

◆ Recommended Cable Assembly Diagram

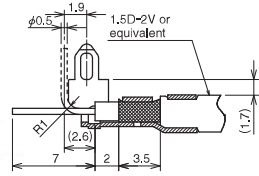

◆ Recommended Board Dimensions

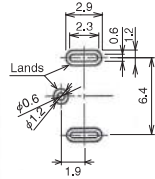

Part No.	HRS No.	Material	Finish	Sales unit	RoHS
GTA-1.6CF(70)	755-0032-2 70	Brass	Tin plating	1,500 pcs/reel	○

◆ Recommended Cable Assembly Diagram

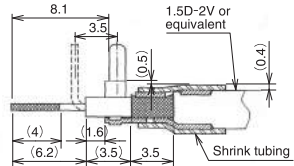
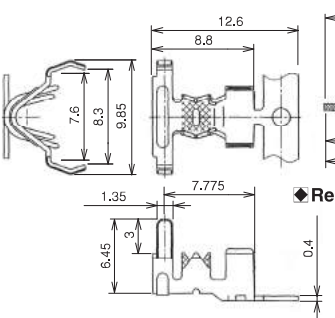
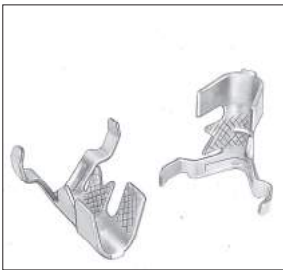

◆ Recommended Board Dimensions

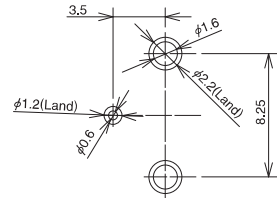

Part No.	HRS No.	Material	Finish	Sales unit	RoHS
GTB-1.6CF(70)	755-0049-5 70	Brass	Tin plating	1,500 pcs/reel	○

◆ Recommended Cable Assembly Diagram

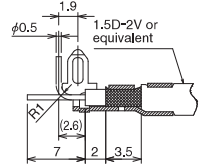
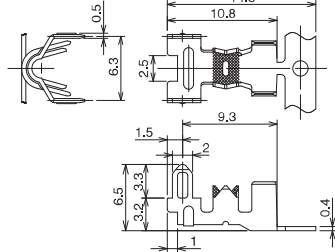

◆ Recommended Board Dimensions

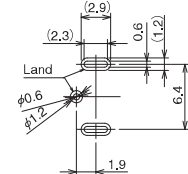

Part No.	HRS No.	Material	Finish	Sales unit	RoHS
GTG-1.6CF	755-0106-7	Brass	Tin plating	1,500 pcs/reel	○

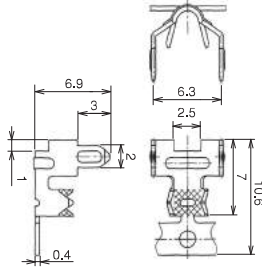
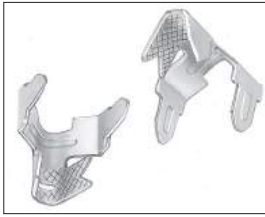

Part No.	HRS No.	Material	Finish	Sales unit	RoHS
G-1.6PCF(70)	755-0029-8 70	Brass	Tin plating	1,500 pcs/reel	○

Recommended Cable Assembly Diagram

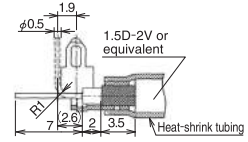

Recommended Board Dimensions

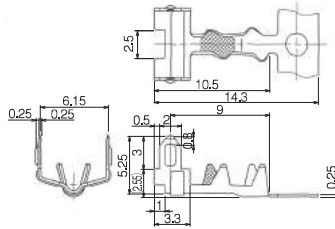
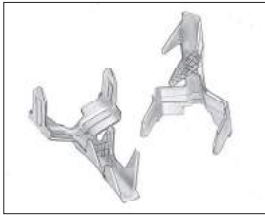
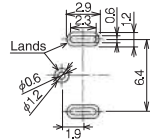

Part No.	HRS No.	Material	Finish	Sales unit	RoHS
GTA-0.7CF	755-0074-2	Brass	Tin plating	1,500 pcs/reel	○

Recommended Cable Assembly Diagram

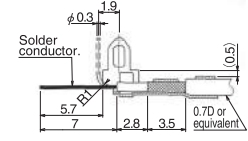

Recommended Board Dimensions

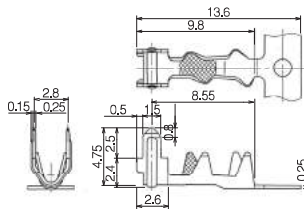
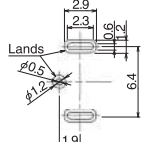

Part No.	HRS No.	Material	Finish	Sales unit	RoHS
GTB-0.7CF	755-0075-5	Brass	Tin plating	1,500 pcs/reel	○

Recommended Cable Assembly Diagram

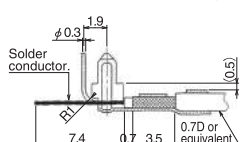

Recommended Board Dimensions

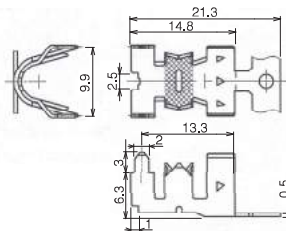
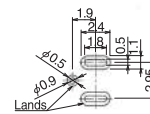

Part No.	HRS No.	Material	Finish	Sales unit	RoHS
GTE-3.7CF	755-0122-3	Brass	Tin plating	1,100 pcs/reel	○

Recommended Cable Assembly Diagram

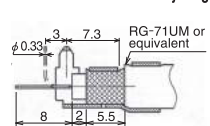

Recommended Board Dimensions

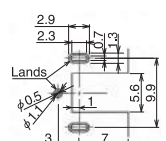

GT5 GT13 GT16 GT19 GT21
 Dec. 1, 2021 Copyright 2021 HIROSE ELECTRIC CO., LTD., All Rights Reserved.
 FH65 FH40 FH35 FH27

Shield Plate

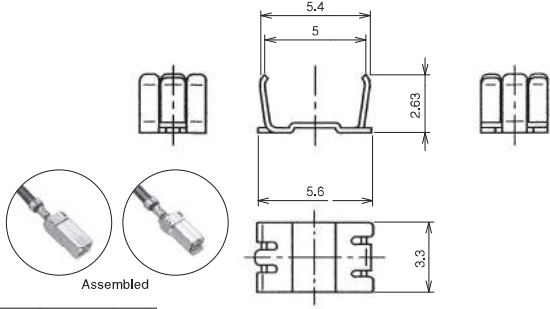

Part No.	HRS No.	Material	Finish	Sales unit	RoHS
GT5C-1P/S-CSB(70)	755-0048-2 70	Brass	Tin plating	1	○

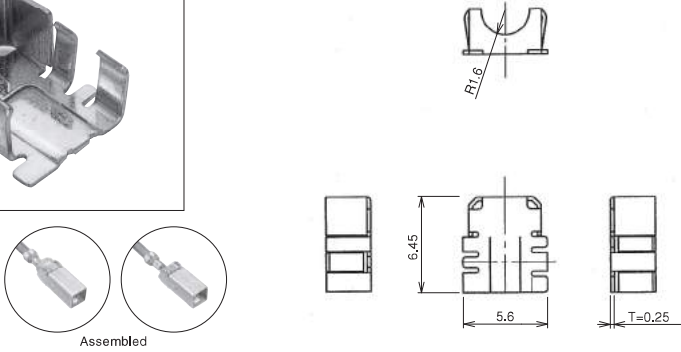
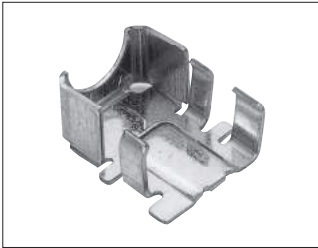

Part No.	HRS No.	Material	Finish	Sales unit	RoHS
GT5C-1P/S-CSB(70)	755-0088-7 70	Brass	Tin plating	1	○

Panel Mount In-line Bracket

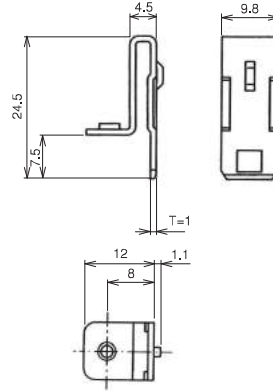

Part No.	HRS No.	Material	Finish	Used with connectors	Sales unit	RoHS
GT-BK(70)	751-0039-6 70	SPCC	Tin plating	GT5-1PP-HU(70), GT5-1PP-HU(A)(70), GT5-1PP-HU(B)(70) GT5-1PP-HU(C)(70), GT5-1PP-HU(D)(70) GT5-1PP-HU(E)(70), GT5-1PP-HU(F)(70) GT5-1PP-HU(G)(70), GT5-1PP-HU(H)(70) GT5-2/1PP-HU(70), GT5-2PP-HU(70) GT5-2PP-HU(A)(70), GT5-2PP-HU(B)(70) GT5-2PP-HU(C)(70)	1	○

Crimping Tools

Please ask your Hirose Electric account representative for a user manual.

Automatic Crimping Machine



Photo for reference only.
Subject to change.

Part No. CM-105C

Specifications

Item	Specifications	Remarks
Press capacity	1,5tons	
Stroke length	30mm	
Number of strokes	200spm (50Hz)	200spm (60Hz)
Weight	75kg	
Motor	0.2kW	AC100V
Crimping speed	2,000-4,000/H	

*Terminal crimp height setting tables are available for each cable type. Please contact your Hirose Electric account representative.

Please note that we will need to define new crimp heights for novel cables and this may take a few days.

● **Harness Tools**

Contact Product No.	Contact HRS No.	Tool No.	Tool HRS No.
GT5-30/0,7-1,5PCF(70)	755-0017-9 70	AP105-GT5-30/0.7-1.5P	901-5021-8
GT5-30/0,7-1,5SCF(70)	755-0065-1 70	AP105-GT5-30/0.7-1.5S	901-5080-7
GT5L-2428/1,6-2,5PCF(70)	755-0079-6 70	AP105-GT5-2428/1,6-2,5P	901-5100-2
GT5-2428/1,6-2,5SCF(70)	755-0078-3 70	AP105-GT5-2428/1,6-2,5S	901-5101-5
GT5-30/1,6-2,9PCF(70)	755-0021-6 70	AP105-GT5-30/1,6-2,9P-ID	901-5019-6
		AP105-GT5-30/1,6-2,9P	901-5017-0
GT5-30/1,6-2,9SCF(70)	755-0022-9 70	AP105-GT5-30/1,6-2,9S-ID	901-5020-5
		AP105-GT5-30/1,6-2,9S	901-5018-3
GT5-2428/1,6-2,9PCF(70)	755-0001-9 70	AP105-GT5-2428/1,6-2,9P	901-5029-0
		AP105-GT5-2428/1,6-2,9PWS	901-5031-3
		AP105-GT5-2428/1,6-2,9P-B	901-5103-0
GT5-2428/1,6-2,9SCF(70)	755-0002-1 70	AP105-GT5-2428/1,6-2,9S	901-5030-9
		AP105-GT5-2428/1,6-2,9SWS	901-5032-4
		AP105-GT5-2428/1,6-2,9S-B	901-5104-3
GT5-2022/1,6-2,9SCF(70)	755-0071-4 70	AP105-GT5-2022/1,6-2,9S	901-5088-9
GT5-2022/F2,7-3,5PCF(70)	755-0076-8 70	AP105-GT5-2022/F2,7-3,5P	901-5091-3
GT5-2022/F2,7-3,5SCF(70)	755-0077-0 70	AP105-GT5-2022/F2,7-3,5S	901-5092-6
GT5-2022/F3,3-3,8PCF(70)	755-0053-2 70	AP105-GT5-2022/F3,3-3,8P	901-5075-7
GT5-2022/F3,3-3,8SCF(70)	755-0054-5 70	AP105-GT5-2022/F3,3-3,8S	901-5076-0
GT5-2022/F3,3-5PCF(70)	755-0033-5 70	AP105-GT5-2022/F3,3-5P-ID	901-5058-8
		AP105-GT5-2022/F3,3-5P	901-5059-0
GT5-2022/F3,3-5SCF(70)	755-0034-8 70	AP105-GT5-2022/F3,3-5S-ID	901-5060-0
		AP105-GT5-2022/F3,3-5S	901-5061-2
GT5-30/F4-5PCF(70)	755-0019-4 70	AP105-GT5-30/F4-5P-ID	901-5033-7
GT5-30/F4-5SCF(70)	755-0020-3 70	AP105-GT5-30/F4-5S-ID	901-5034-0
GT5-2428/F4-5PCF(70)	755-0023-1 70	AP105-GT5-2428/F4-5P-ID	901-5035-2
		AP105-GT5-2428/F4-5P-3C2V	901-5056-2
GT5-2428/F4-5SCF(70)	755-0024-4 70	AP105-GT5-2428/F4-5S-ID	901-5036-5
		AP105-GT5-2428/F4-5S-3C2V	901-5057-5
GT5-2022/F4-5PCF(70)	755-0035-0 70	AP105-GT5-2022/F4-5P	901-5052-1
		AP105-GT5-2022/F4-5P-18ID	901-5121-2
GT5-2022/F4-5SCF(70)	755-0036-3 70	AP105-GT5-2022/F4-5S	901-5053-4
		AP105-GT5-2022/F4-5S-18ID	901-5102-8
G-1,6PCF(70)	755-0029-8 70	AP105-G-1,6P	901-5041-5
GTA-0,7CF	755-0074-2	AP105-GTA,B-0,7P	901-5141-0
GTB-0,7CF	755-0075-5	AP105-GTA,B-0,7P	901-5141-0
GTA-1,6CF(70)	755-0032-2 70	AP105-GTA,B-1,6P	901-5047-1
GTB-1,6CF(70)	755-0049-5 70	AP105-GTA,B-1,6P	901-5047-1
GTC-1,6CF	755-0106-7	AP105-GTA,B-1,6P	901-5047-1
GTE-3,7CF	755-0122-3	AP105-GTE-3,7	901-5151-3

Please refer to our cable termination procedure manual for performing terminations.

Dec. 1, 2021. Copyright 2021 HIROSE ELECTRIC CO., LTD. All Rights Reserved.

Mouser Electronics

Authorized Distributor



Click to View Pricing, Inventory, Delivery & Lifecycle Information:

[Hirose Electric:](#)





[GT5-1PP-HU\(70\)](#) [GT5-1PP-HU\(B\)\(70\)](#) [GT5-1S-HU\(A\)](#) [GT5-1S-HU\(B\)](#) [GT5-2P/S-R](#) [GT5-2S-HU](#) [GT5-4P/S-R](#) [GT5-4P-DS\(70\)](#) [GT5-2428/1.6-2.5SCF\(70\)](#) [GT5-2428/1.6-2.9SCF\(70\)](#) [GT5-1P-DS\(70\)](#) [GT5-1P-DS\(A\)\(70\)](#) [GT5-2428/1.6-2.9PCF\(70\)](#) [GT5-1P/S-R](#) [GT5-1S-HU](#) [GT5-2428/1.1-2.2SCF](#)

Looking for pricing, stock, or lifecycle information?

Click below to explore more details on WIN SOURCE:

-  [View GT5-2S-HU on WIN SOURCE](#)
-  [Hirose Electric Co Ltd Information](#)

Optimize Your Supply Chain with WIN SOURCE Solutions

-  Global Sourcing Solution
-  Obsolete Management
-  Cost Control Management
-  Shortage Management
-  Alternative Solution
-  Excess Inventory Management