



THE DATASHEET OF
SL4949



1. Overview

SL4949 is a low voltage drop LDO voltage regulator with the output voltage of 5V, integrated with the power on reset function and the input voltage monitoring function in the chip.

SL4949 can provide stable supply voltage for the control system of micro-processors, with typical output current as high as 100mA and transient input voltage of 42V, and is very suitable for applications in working environment of automotive electronics.

Supporting Reset output, it can be applied to logic control of micro-processors, in addition, it supports Sense monitoring, and can output the warning signal before the output of the reset signal. Reasonable use of the Sense monitoring function can make micro-processors conduct necessary treatment measures before the stop of micro-processors with Reset.

2. Characteristics

- Working voltage ranges: 5.5V~42V
- Extremely low quiescent current of 80uA in the standby ;
- High-accuracy standby output voltage: 5V±1%
- Typical output current of 100mA
- Voltage difference less than 0.4V
- It supports the Reset output function, and the reset delay time can be set;
- It supports the Sense voltage monitoring function
- Over-temperature protection and short circuit -limiting protection
- RoHS

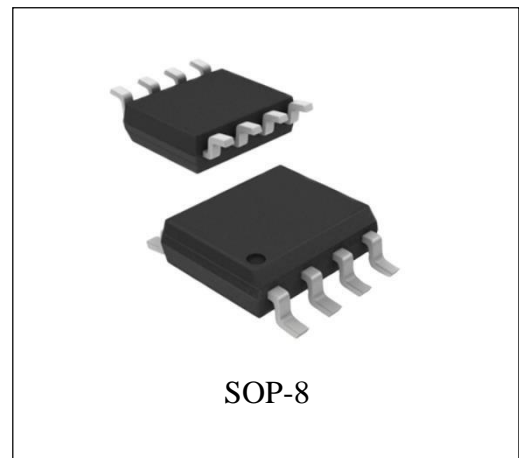

Application fields:

- Automobile electronics
- Personal computer
- White home appliances
- Industrial control products and electronic medical apparatus and instruments

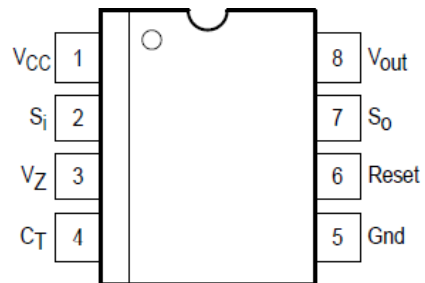
3.Description of pins

Top view

Figure 3-1 Distribution diagram of pins of SL4949

Pin	Symbol	Description
1	Vin	Power supply end
2	Sense	Voltage monitoring input end
3	Vz	Output end of the internal pre-treatment module
4	CT	Reset delay setting
5	GND	Ground
6	Reset	Reset output
7	So	Voltage monitoring output end
8	Vout	Voltage stabilization output end
Exposed Pad		Bottom cooling fin, with internal connection to GND

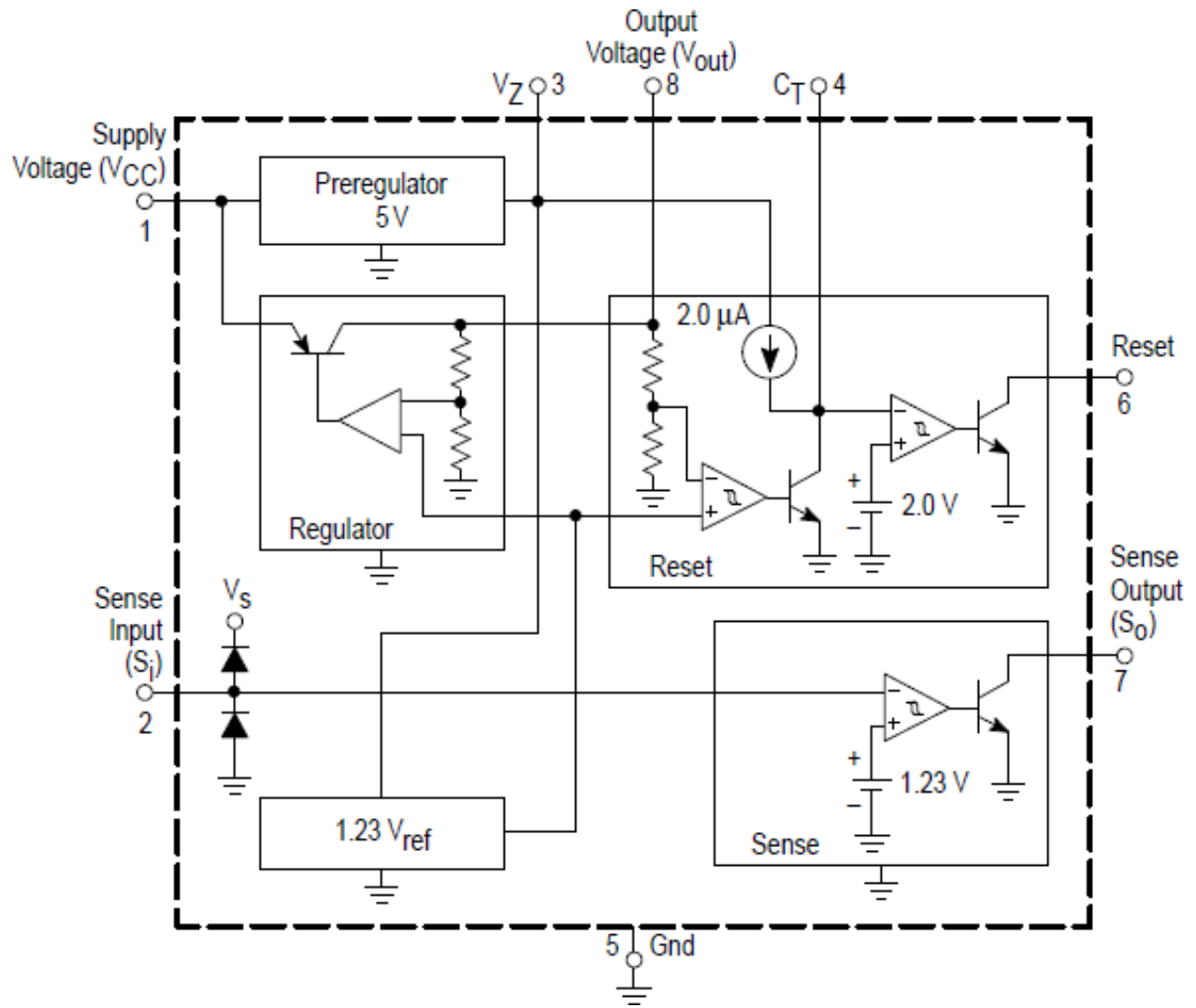

Figure 3-2 Internal schematic diagram of SL4949

4. Electrical parameters

Table 4.1 Max. rated ranges (TA=25°C)

Parameters	Symbols	Values			Units	Remark
		Min	Typ	Max		
Supply voltage	V _{CC}	-	-	42	V	
Output current	I _{out}			330	mA	Internal current limiting
Output voltage	V _{out}	4.95	5	5.05	V	
Sense input current	I _{SI}	-	±1	-	mA	
Sense input voltage	V _{SI}		V _{CC}			
Output voltage of the internal pre-treatment module	V _Z		5		V	
Output current of the internal pre-treatment module	I _Z		5		mA	
Maximum junction temperature	T _j	-	-	150	°C	
Storage temperature	T _{stg}	-40	-	150	°C	

Remarks: Long-term storage of devices in environments with temperature higher than the maximum rated value will lead to influences on reliability of the devices.

The maximum rated values mentioned above are the absolute values; permanent damages will be caused if any of the parameters exceeds the maximum value mentioned above.

Table 4.2 Thermal resistance (TA=25°C)

Parameters	Symbols	Values			Units	Remark
		Min	Typ	Max		
Thermal resistance	R _{thJS}	-	-	200	K/W	SL4949

**Table 4.3 Electrical characteristics
(VCC=13.5V, TA=25°C)**

Parameters	Symbols	Values			Units	Remark
		Min	Typ	Max		
Output voltage	V _{OUT}	4.95	5.0	5.05	V	I _{out} =1.0mA
Output voltage	V _{OUT}	4.9	5.0	5.1	V	6.0V<VCC<28V 1.0mA<I _{out} <50mA
Output voltage	V _{OUT}	4.9	5.0	5.1	V	VCC=35V, t<1.0S 1.0mA<I _{out} <50mA
Output current limiting	I _{OUT}	100	-	330	mA	
Voltage drop	V _{drop}	-	0.1	0.25	V	I _{out} =10mA
		-	0.2	0.40	V	I _{out} =50mA
		-	0.3	0.50	V	I _{out} =100mA
Input voltage regulation ratio	Reg _{line}	-	1.0	20	mV	6.0V<VCC<28V I _{out} =1.0mA
Load regulation ratio	Reg _{load}	-	8.0	30	mV	1.0mA<I _{out} <100mA
Current limiting value	I _{Lim}	105	-	330	mA	V _{out} =4.5V
		-	100	-	mA	V _{out} =0V
Quiescent current	I _{QSE}	-	80	100	uA	I _{out} =0.3mA, T _J <100°C
	I _Q		350	400	uA	I _{out} =100mA

Reset

Reset threshold voltage		V _{out} -0.7			V	
Reset threshold hysteresis	V _{Resth, hys}	50	100	200	mV	@T _J =25°C
		50	-	300	mV	@T _J =-40~150°C
Reset delay	t _{ResD}	55	100	180	ms	C _T =100nF, t _R ≥100us
Reset response time	t _{ResR}	-	5.0	30	us	C _T =100nF
Reset output low level	t _{ResL}	-	-	0.4	V	R _{Reset} =10kΩ VCC≥3.0V
Reset leakage current	t _{ResH}	-	-	1.0	uA	V _{Reset} =5.0V
Threshold voltage of delay comparator	V _{CTth}	-	2.0	-	V	

Threshold hysteresis of delay comparator	$V_{CTh. hys}$	-	100	-	mV	
--	----------------	---	-----	---	----	--

SENSE

Sense threshold value	V_{SOth}	1.16	1.23	1.35	V	$V_{SI}=1.5V\sim 1.0V$
Sense threshold hysteresis	$V_{SOth. hys}$	20	100	200	mV	
Sense output low level	V_{SOL}	-	-	0.4	V	$V_{SI}\leq 1.16V$ $V_{CC}\geq 3.0V$ $R_{SO}=10k\Omega$ to V_{out}
Sense output leakage current	I_{SOH}	-	-	1.0	μA	$V_{SO}=5.0V$ $V_{SI}\geq 1.5V$
Sense input current	I_{SI}	-1.0	0.1	1.0	μA	

PREREGULATOR

Output voltage of the internal pre-treatment module	V_Z	-	5.0	-	V	$I_Z=10\mu A$
---	-------	---	-----	---	---	---------------

5. Typical parameter curve

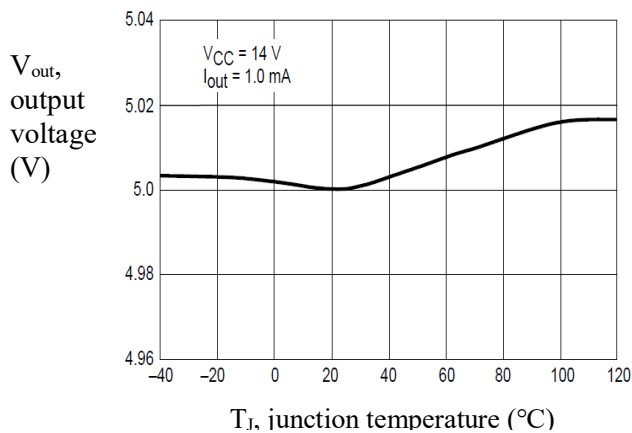

Figure 5-1 Relation scheme between output voltage and junction temperature

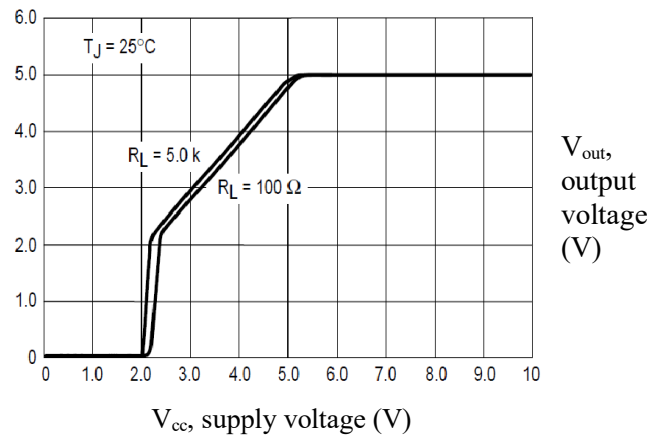

Figure 5-2 Relation scheme between output voltage and supply voltage

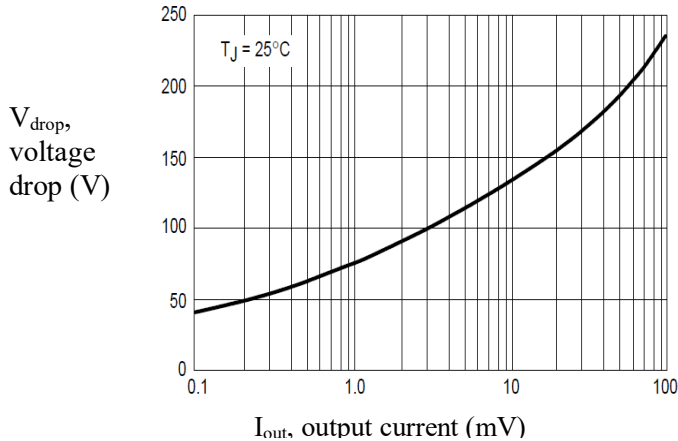

Figure 5-3 Relation scheme between voltage drop and output current

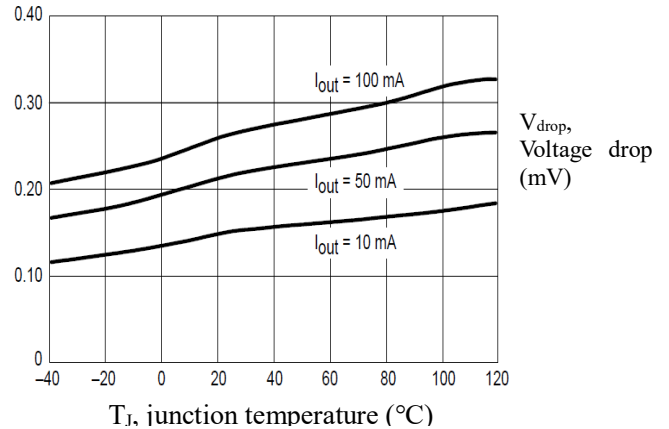

Figure 5-4 Relation scheme between voltage drop and junction temperature

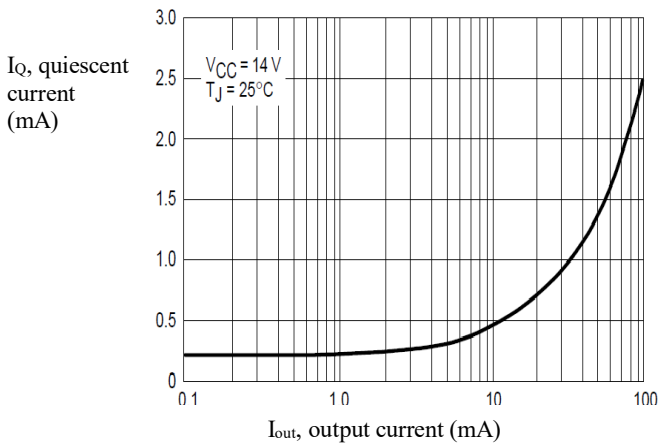

Figure 5-5 Relation scheme between quiescent current and output current

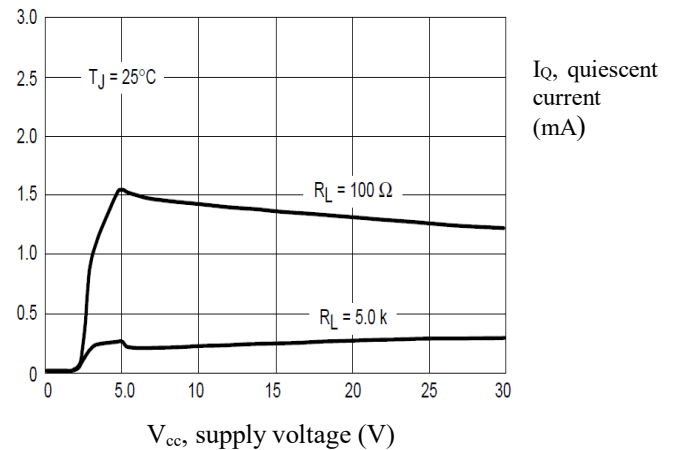

Figure 5-6 Relation scheme between quiescent current and input voltage

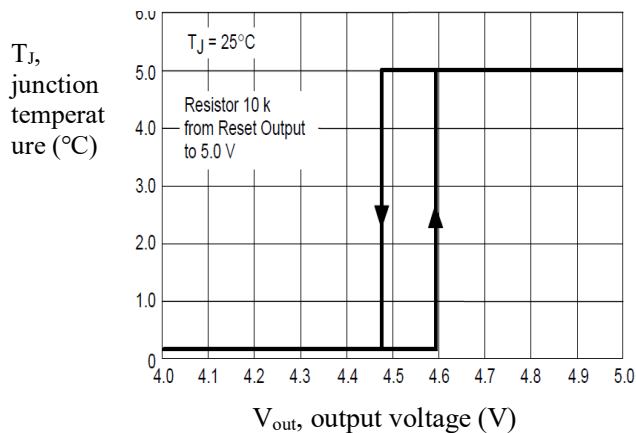

Figure 5-7 Relation scheme between Reset output voltage and output voltage

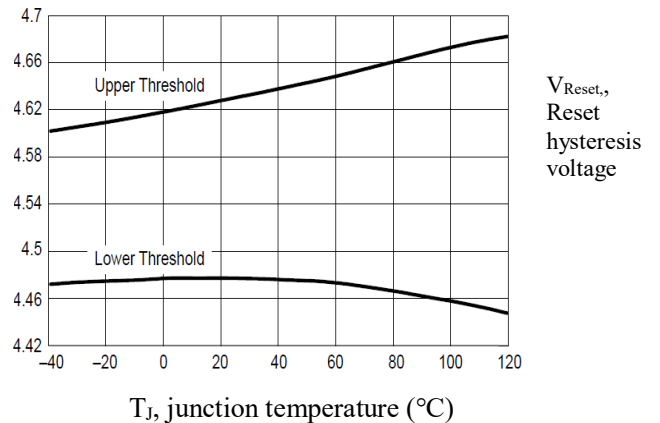

Figure 5-8 Relation scheme between Reset hysteresis voltage and junction temperature

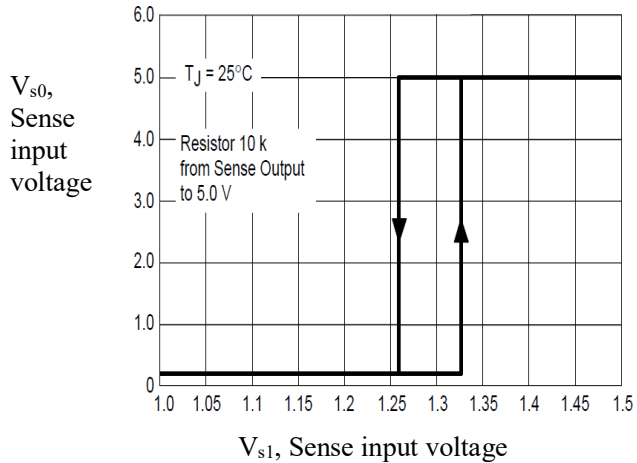

Figure 5-9 Relation scheme between Sense output voltage and Sense input voltage

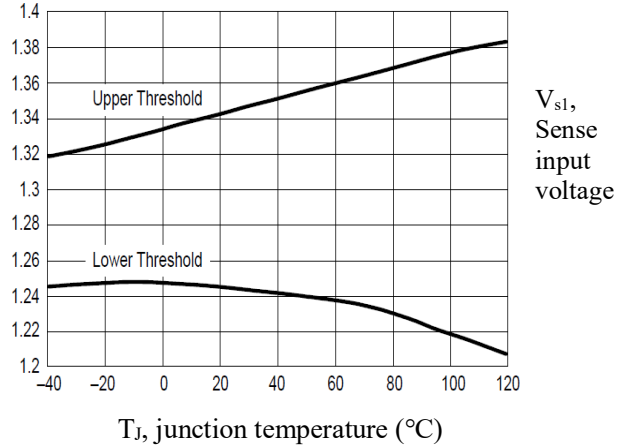
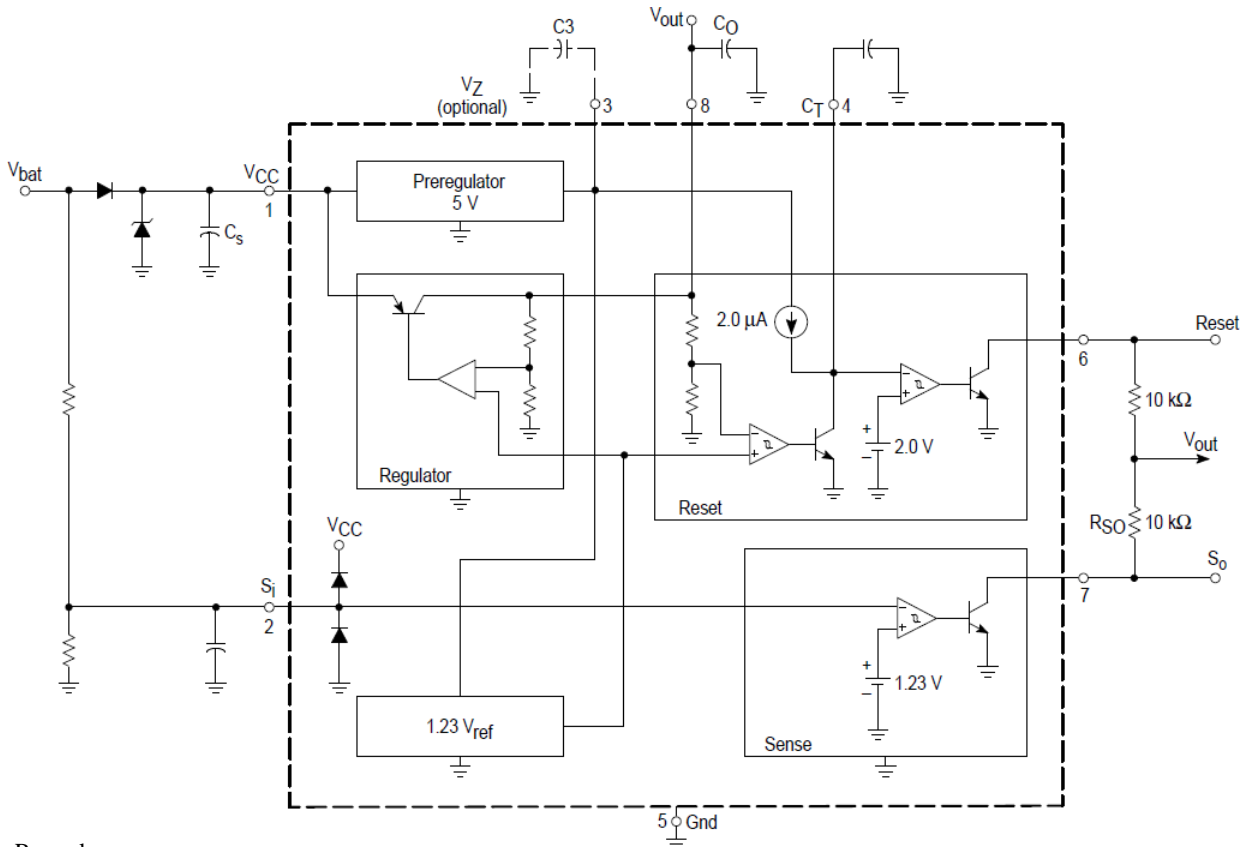

Figure 5-10 Relation scheme between Sense input voltage and junction temperature

6.Applications

Transient supply voltage

Transient changes in supply voltage may lead to mis-flip of the Reset output signal. When the supply voltage is higher than 8.0V and the transient change in supply voltage is higher than 100V/us, the chip has very strong anti-jamming capability, and the Reset output signal is stable. When the supply voltage is lower than 8.0V, and the transient change of the supply voltage is lower than 0.4V/us, the Reset output signal flip will be triggered. In order to improve the anti-jamming capability of the chip when the supply voltage is lower than 8.0V, connect a capacitor to Pin 3, which ($C3 \leq 1.0\mu\text{F}$) can also reduce output noises.



Remarks:

1. $C_s \geq 1.0 \mu F$, $C_o \geq 4.7 \mu F$, $ESR < 10 \Omega$;
2. It is suggested to make $C_o = C_s = 10 \mu F$

Figure 6-1 Typical application drawing

SL4949 is a low voltage drop LDO voltage regulator with the output voltage of 5V, which can meet requirements on power supply by micro-processor systems in automobiles, at the same time, **SL4949** is applicable to other fields. The modularized design is adopted for the chip, so that all functions can work separately.

6.1 Voltage regulator

An independent vertical PNP is taken as the output device of the voltage regulator. This structure is adopted with the following advantage: When the output current achieves 100mA, the voltage drop on the output end is very small. When the input voltage is lower than 40V, the output voltage is stable, and **SL4949** will not stop working due to overvoltage pulse.

The output voltage of SL4949 changes with the change of the supply voltage, as shown in Figure 6-2.

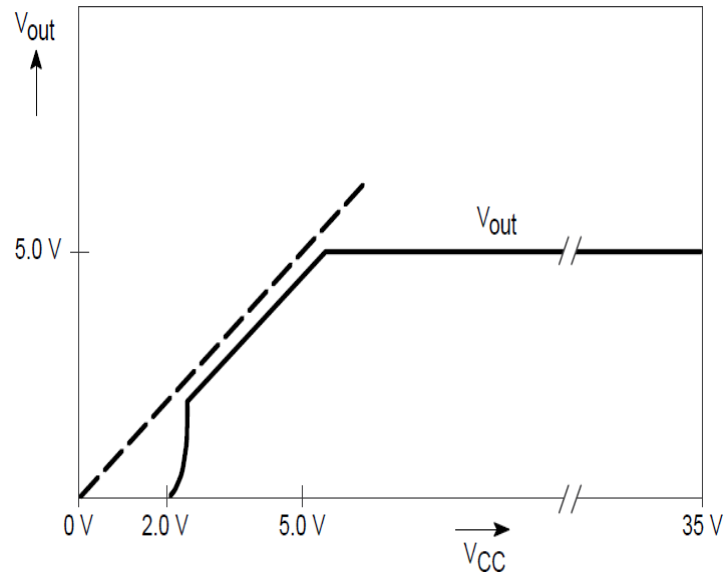

Figure 6-2 Relation scheme between output voltage and input voltage

The quiescent current of SL4949 is smaller than 100uA. When the load disconnects, with the rise in the input voltage, SL4949 keeps almost unchanged, with the typical value of 80uA.

Short circuit protection: There is a current limiting module in SL4949, with the current limiting value of 330mA.

6.2 Internal preprocessing module

In order to improve the transient anti-jamming capability of the chip, there is a preprocessing module in SL4949, which provides a stable 5V internal power supply for other modules. The internal supply voltage is led out of the chip through Pin 3 (Vz). Considering of limited driving capacity of the internal supply voltage, it is suggested to not take Vz as an output end.

When the supply voltage is lower than 8V, in order to improve the transient anti-jamming capability of the chip, it is needed to add a capacitor between Pin 3 and the ground (100nF~1.0uF); in other conditions, it is suggested to make Pin 3 suspended in midair.

6.3 Reset circuit

The schematic diagram of the Reset circuit is as shown in Figure 6-3.

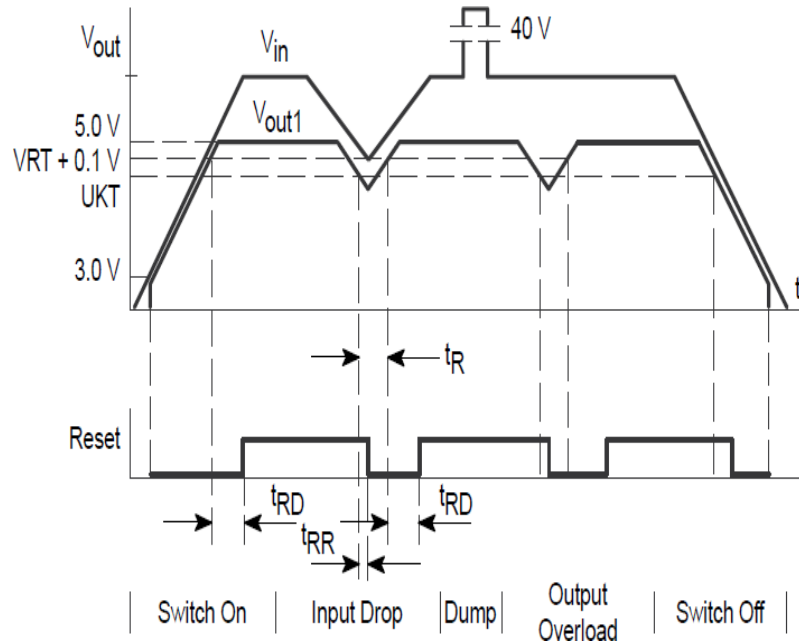

Figure 6-4 Typical Reset output waveform

6.4 Sense comparator circuit

The Sense comparator circuit is utilized to monitor the supply voltage. The use of the external voltage divider makes the application of the Sense comparator more flexible.

Before or after the enabling of the protective diode in the chip, reasonable use the Sense monitoring input voltage to provide additional information for micro-processor of the system, such as low voltage warning.

7.Package Specifications

SOP-8 package dimension

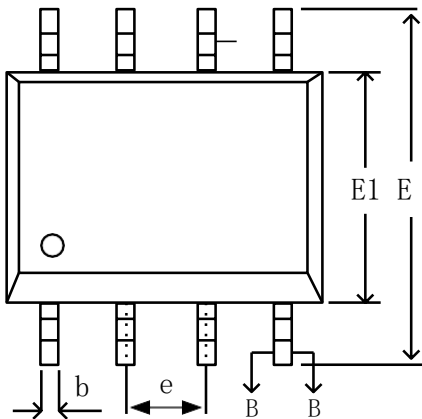
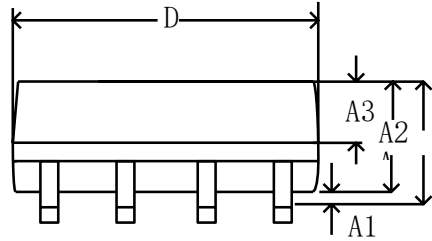

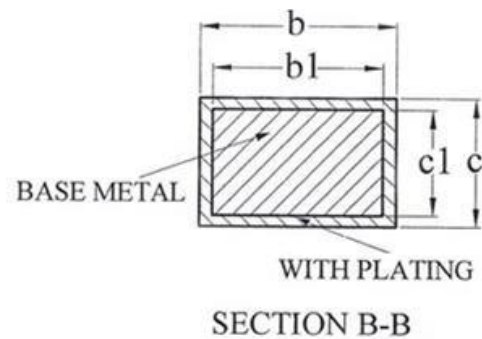
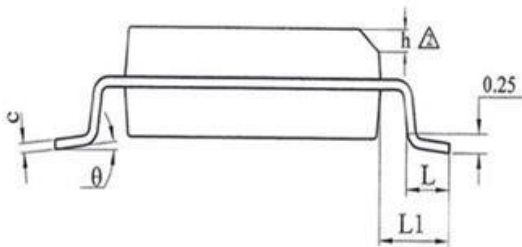

SYMBOL	MILLIMETER		
	MIN	NOM	MAX
A	—	-	1.75
A1	0.10	-	0.225
A2	1.30	1.40	1.50
A3	0.60	0.65	0.70
b	0.39	-	0.48
b1	0.38	0.41	0.43
c	0.21	-	0.26
c1	0.19	0.20	0.21
D	4.70	4.90	5.10
E	5.80	6.00	6.20
E1	3.70	3.90	4.10
e	1.27 BSC		
h	0.25	—	0.50
L	0.50	—	0.80
L1	1.05 BSC		
⌀	0	—	8
L/F carrier dimension (mil)	80*80	90*90	95*130



Looking for pricing, stock, or lifecycle information?

Click below to explore more details on WIN SOURCE:

-  [View SL4949 on WIN SOURCE](#)
-  [ShenZhen SikorMicro Semicon Co. Ltd Information](#)

Optimize Your Supply Chain with WIN SOURCE Solutions

-  Global Sourcing Solution
-  Obsolete Management
-  Cost Control Management
-  Shortage Management
-  Alternative Solution
-  Excess Inventory Management