



**THE DATASHEET OF
CDRH125L125NP-330MC**



SMD Power Inductor CDRH125/L125



Description

- Ferrite drum core construction.
- Magnetically shielded.
- L × W × H: 12.3 × 12.3 × 6.0 mm Max.
- Product weight: 3.0g(Ref.)
- Moisture Sensitivity Level: 1
- RoHS compliance.
- Qualified to AEC-Q200.

Environmental Data

- Operating temperature range: -40°C ~ +125°C (including coil's self temperature rise)
- Storage temperature range: -40°C ~ +125°C
- Solder reflow temperature: 260 °C peak.

Packaging

- Carrier tape and reel packaging
- 13.0" diameter reel
- 500pcs per reel

Applications

- Automotive.

Dimension - [mm]

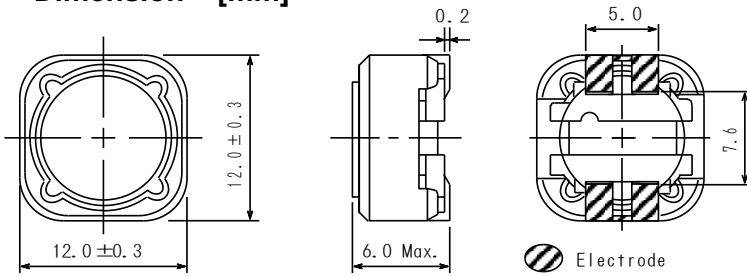

Land pattern and Schematics - [mm]

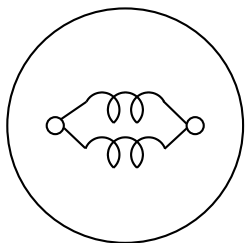
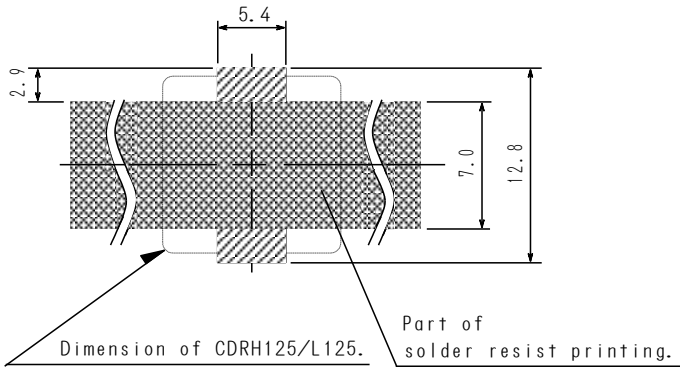

(1.2µH~47µH)

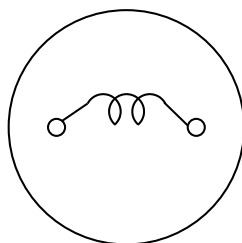

(68µH~1.0mH)



Electrical Characteristics

Part Name	Stamp	Inductance (μ H) ※1	D.C.R.(Ω) Max.(Typ.) (at 20°C)	Saturation Current (A) ※2		Temperature Rise Current (A) ※3
				at 20°C	at 125°C	
CDRH125L125NP-1R2NC	1R2	1.2 \pm 30%	8.5m(6.8m)	14.20	11.60	9.00
CDRH125L125NP-1R8NC	1R8	1.8 \pm 30%	10.6m(8.5m)	12.60	10.10	8.00
CDRH125L125NP-2R7NC	2R7	2.7 \pm 30%	12.8m(10.2m)	10.20	8.20	7.40
CDRH125L125NP-3R9NC	3R9	3.9 \pm 30%	15.0m(12.0m)	8.20	6.70	6.80
CDRH125L125NP-5R1NC	5R1	5.1 \pm 30%	17.5m(14.0m)	7.20	5.90	6.50
CDRH125L125NP-6R8NC	6R8	6.8 \pm 30%	20.0m(16.0m)	6.20	4.90	5.90
CDRH125L125NP-100MC	100	10 \pm 20%	25.0m(20.0m)	5.20	4.10	5.30
CDRH125L125NP-150MC	150	15 \pm 20%	33.8m(27.0m)	4.40	3.50	4.50
CDRH125L125NP-220MC	220	22 \pm 20%	39.5m(31.5m)	3.50	2.81	3.70
CDRH125L125NP-330MC	330	33 \pm 20%	59.0m(47.0m)	2.93	2.38	3.00
CDRH125L125NP-470MC	470	47 \pm 20%	93.0m(74.0m)	2.44	2.00	2.42
CDRH125L125NP-680MC	680	68 \pm 20%	131m(105m)	2.02	1.65	2.05
CDRH125L125NP-101MC	101	100 \pm 20%	166m(133m)	1.70	1.37	1.82
CDRH125L125NP-151MC	151	150 \pm 20%	271m(217m)	1.36	1.11	1.40
CDRH125L125NP-221MC	221	220 \pm 20%	394m(315m)	1.12	0.90	1.15
CDRH125L125NP-331MC	331	330 \pm 20%	674m(539m)	0.90	0.73	0.90
CDRH125L125NP-471MC	471	470 \pm 20%	858m(686m)	0.75	0.61	0.81
CDRH125L125NP-681MC	681	680 \pm 20%	1.22(1.02)	0.62	0.50	0.65
CDRH125L125NP-102MC	102	1000 \pm 20%	1.90(1.58)	0.52	0.42	0.50

※1. Measuring condition: at 100kHz.

※2. Saturation current: The value of D.C. current when the inductance decreases to 65% of it's nominal value.

※3. Temperature rise current: The value of D.C. current when the temperature rise is $\Delta t=40^{\circ}\text{C}$ ($T_a=20^{\circ}\text{C}$).

SMD Power Inductor CDRH125/L125



Saturation Current & Temperature Rise Graph

— L (20°C) — L (125°C) — ΔT

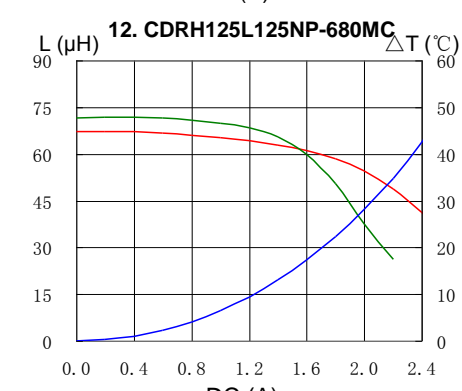
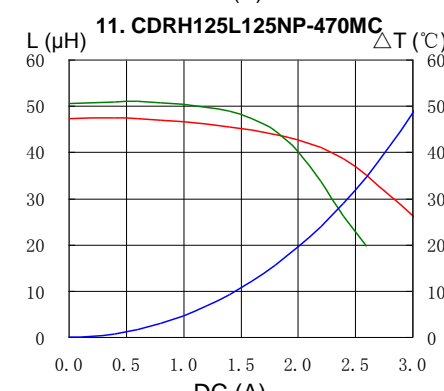
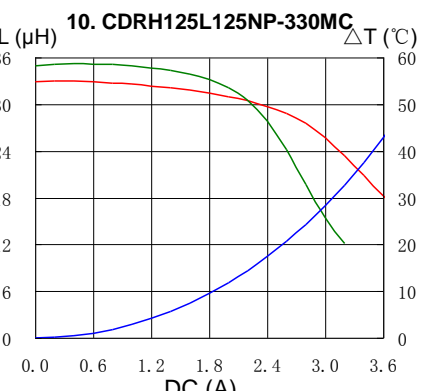
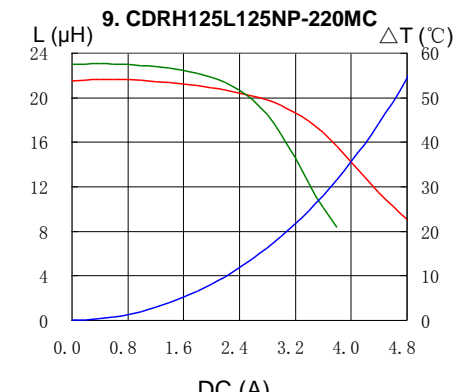
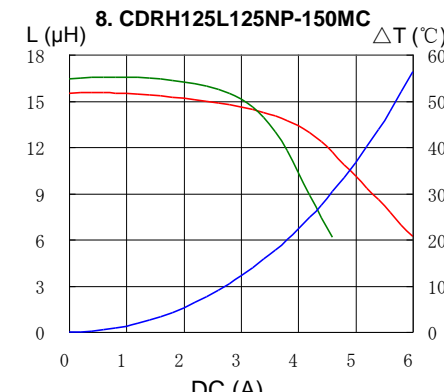
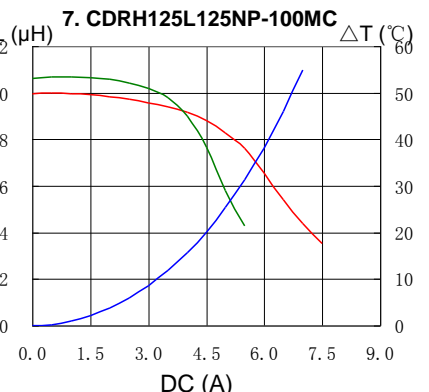
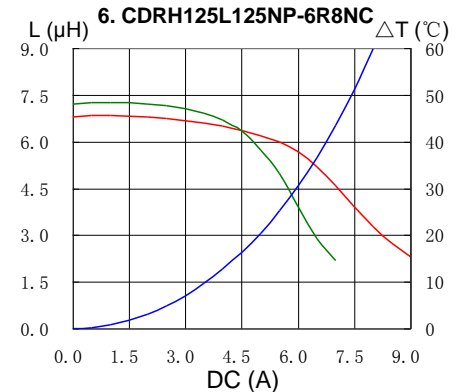
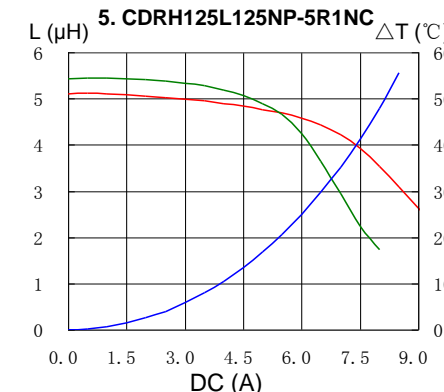
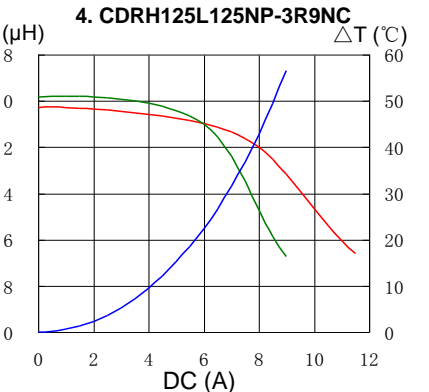
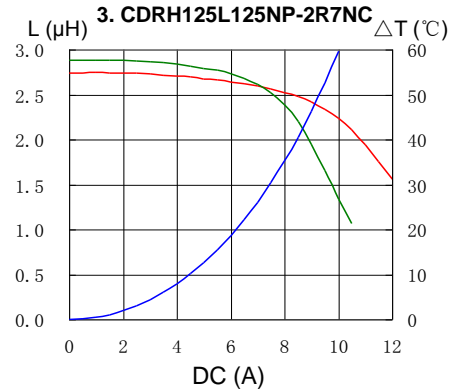
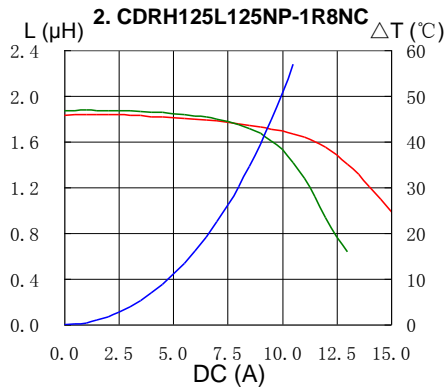
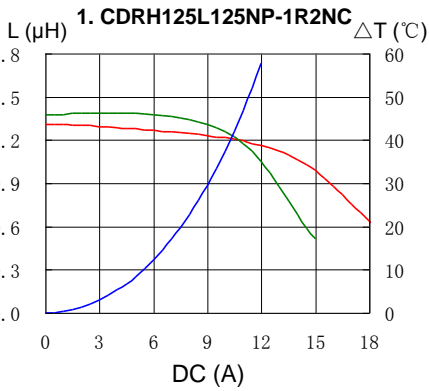

SMD Power Inductor

CDRH125/L125



— L (20°C) — L (125°C) — ΔT

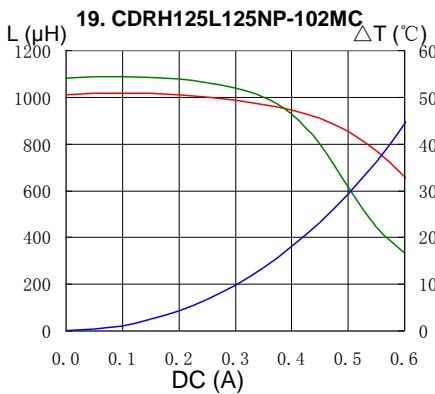
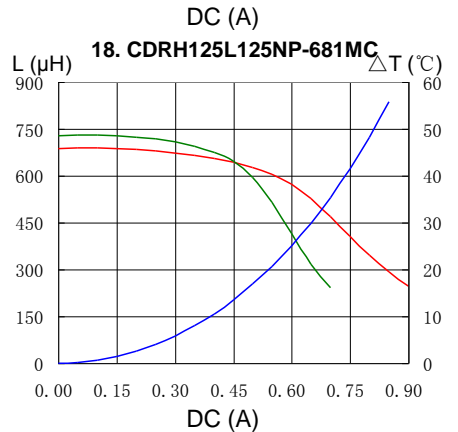
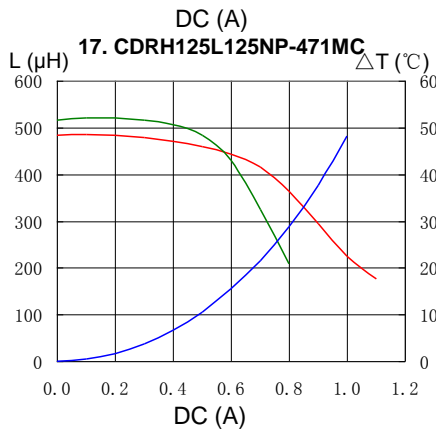
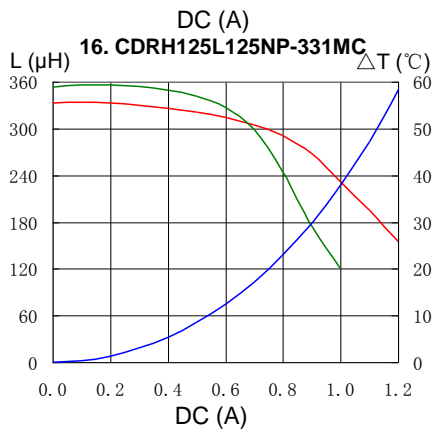
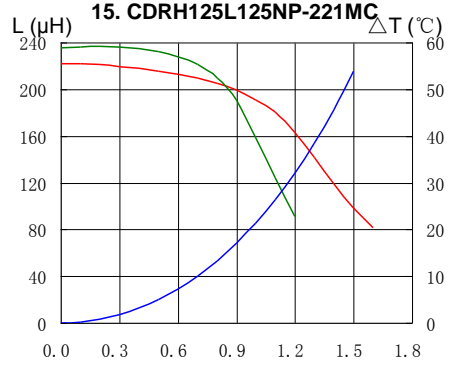
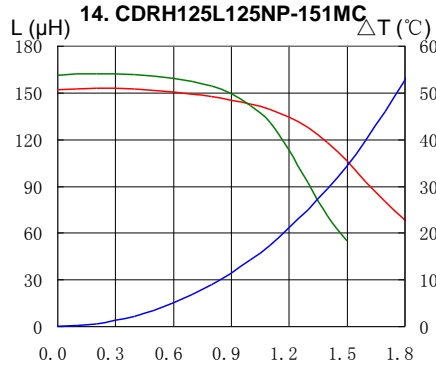
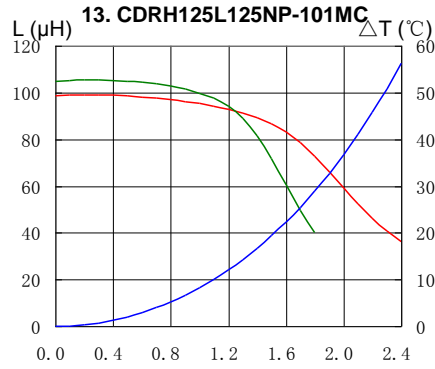

SMD Power Inductor CDRH125/L125



Solder Reflow Condition

Heat Endurance

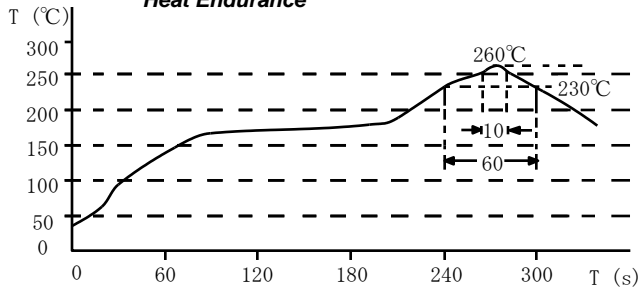

Temperature Chart



Please refer to the sales offices on our website - <http://www.sumida.com>

Hong Kong

Tel. +852-2880-6781
FAX. +852-2565-9600
sales@hk.sumida.com

Saitama(Japan)

Tel. +81-48-691-7300
FAX. +81-48-691-7340
sales@jp.sumida.com

Chicago

Tel. +1-847-545-6700
FAX. +1-847-545-6720
sales@us.sumida.com

Shanghai

Tel. +86-21-5836-3299
FAX. +86-21-5836-3266
shanghai.sales@cn.sumida.com

Seoul

Tel. +82-2-6237-0777
FAX. +82-2-6237-0778
sales@kr.sumida.com

Obernzell

Tel. +49-8591-937-0
FAX. +49-8591-937-103
contact@eu.sumida.com

Shenzhen

Tel. +86-755-8291-0228
FAX. +86-755-8291-0338
shenzhen.sales@cn.sumida.com

Singapore

Tel. +65-6296-3388
FAX. +65-6841-4426
sales@sg.sumida.com

Neumarkt

Tel. +49-9181-4509-110
FAX. +49-9181-4509-310
infocomp@eu.sumida.com

Taipei

Tel. +886-2-8751-2737
FAX. +886-2-8751-2738
sales@tw.sumida.com

San Jose

Tel. +1-408-321-9660
FAX. +1-408-321-9308
sales@us.sumida.com

Looking for pricing, stock, or lifecycle information?

Click below to explore more details on WIN SOURCE:

- ⊖ [View CDRH125L125NP-330MC on WIN SOURCE](#)
- ⊖ [Sumida America Components Inc. Information](#)

Optimize Your Supply Chain with WIN SOURCE Solutions

- ✓ Global Sourcing Solution
- ✓ Obsolete Management
- ✓ Cost Control Management
- ✓ Shortage Management
- ✓ Alternative Solution
- ✓ Excess Inventory Management