



**THE DATASHEET OF
CFR-25JT-52-1K2**



DATA SHEET

CARBON FILM RESISTORS

General Purpose

CFR Series

$\pm 2\%$, $\pm 5\%$

1/6W to 3W

RoHS compliant & Halogen Free



DIMENSIONS

Unit: mm

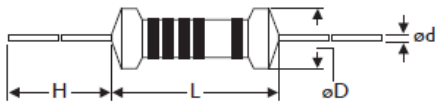

	Normal	Miniature	L	ψD	H	ψd
CFR-12	CFR 25S		3.4 ± 0.3	1.9 ± 0.2	28 ± 2.0	0.45 ± 0.05
CFR -25	CFR 50S		6.3 ± 0.5	2.4 ± 0.2	28 ± 2.0	0.55 ± 0.05
CFR -50	CFR 1WS		9.0 ± 0.5	3.3 ± 0.3	26 ± 2.0	0.55 ± 0.05
CFR 100	CFR 2WS		11.5 ± 1.0	4.5 ± 0.5	35 ± 2.0	0.8 ± 0.05
CFR 200	CFR 3WS		15.5 ± 1.0	5.0 ± 0.5	33 ± 2.0	0.8 ± 0.05

DERATING CURVE

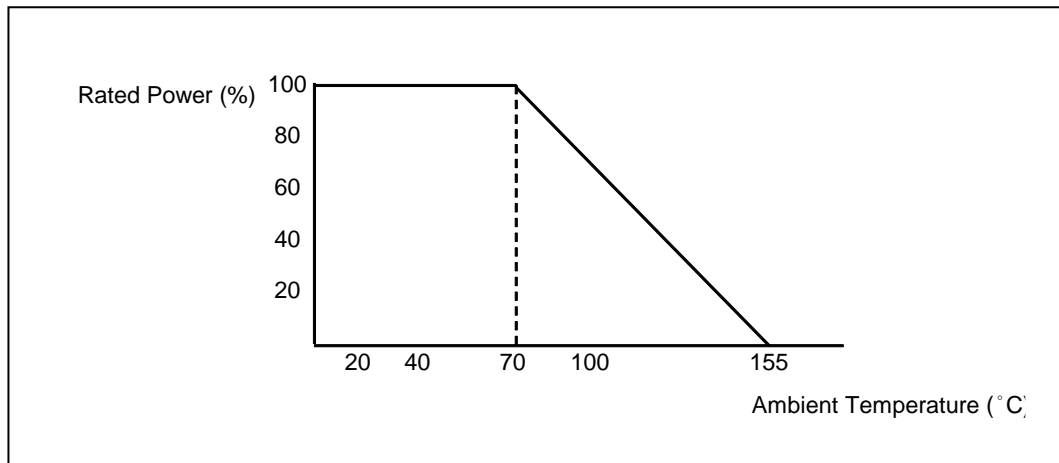

ELECTRICAL CHARACTERISTICS

TABLE 1

CHARACTERISTICS	CFR -12	CFR 25S	CFR -25	CFR 50S	CFR -50	CFR 1WS	CFR 100	CFR 2WS	CFR 200	CFR 3WS
Power Rating at 70 °C	1/6W	1/4W	1/4W	1/2W	1/2W	1W	1W	2W	2W	3W
Maximum Working Voltage	150V	200V	250V	300V	350V	400V	500V	500V	500V	500V
Maximum Overload Voltage	300V	400V	500V	600V	700V	800V	1000V	1000V	1000V	1000V
Voltage Proof on Insulation	300V	400V	500V	500V	500V	700V	1000V	1000V	1000V	1000V
Resistance Range	1Ω ~ 10MΩ for E24 series value									
Operating Temp. Range	- 55°C to +155°C									
Temperature Coefficient	see Table 2									

Note: For resistance value out of above range is by request.

TABLE 2 TEMPERATURE COEFFICIENT

TYPE	Temp. Coefficient ppm/°C		
	Under 100KΩ	100K ~ 1MΩ	1M ~ 10MΩ
CFR100, CFR200, CFR2WS CFR3WS	± 350	-500~0	-1500~0
CFR-12 , CFR-25 , CFR-50 CFR25S , CFR50S , CFR1WS	- 500 ~ +350	-700~0	-1500~0

TEST AND REQUIRMENTS

TEST	TEST METHOD	PROCEDURE	APPRAISE
Short Time Overload	IEC 60115-1 4.13	2.5 times RCWV for 5 sec.(Not more than maximum overload voltage)	±0.75%+0.05Ω
Voltage Proof on Insulation	IEC 60115-1 4.7	In V-Block for 60 sec. test voltage as above table	No Breakdown
Temperature Coefficient	IEC 60115-1 4.8	Between -55°C to +155°C	By Type
Insulation Resistance	IEC 60115-1 4.6	In V-Block for 60 sec.	>1,000MΩ
Solderability	IEC 60115-1 4.17	245±5°C for 3±0.5 Sec.	95% Min. coverage
Solvent Resistance of Marking	IEC 60115-1 4.30	IPA for 5±0.5 Min. with ultrasonic	No deterioration of coatings and markings
Robustness of Terminations	IEC 60115-1 4.16	Direct load for 10 Sec. in the direction of the terminal leads	≥2.5Kg(24.5N)
Periodic-pulse Overload	IEC 60115-1 4.39	4 times RCWV(or Umax., whichever less) 10,000 cycles (1 Sec. on, 25 Sec.off)	±1.0%+0.05Ω
Damp Heat Steady State	IEC 60115-1 4.24	40±2°C,90-95% RH for 56 days, loaded with 0.1 times RCWV (or Umax., whichever less)	±3.0%+0.05Ω
Endurance at 70°C	IEC 60115-1 4.25	70±2°C at RCWV(or Umax., whichever less) for 1,000 Hr.(1.5 Hr.on,0.5 Hr. off)	±3.0%+0.05Ω
Temperature Cycling	IEC 60115-1 4.19	-55°C → Room Temp. → +155°C → Room Temp.(5 cycles)	±1.0%+0.05Ω
Resistance to Soldering Heat	IEC 60115-1 4.18	260±3°C for 10±1 Sec., immersed to a point 3±0.5mm from the body	±1.0%+0.05Ω

Note:

RCWV (Rated Continuous Working Voltage):

The DC or AC (rms) continuous working voltage corresponding to the rated power is determined by the following formula:

$$V = \sqrt{P \times R}$$

or max. working voltage whichever is less

Where

V=Continuous rated DC or
AC (rms) working voltage (V)

P=Rated power (W)

R=Resistance value (Ω)

PULSE DIAGRAMS

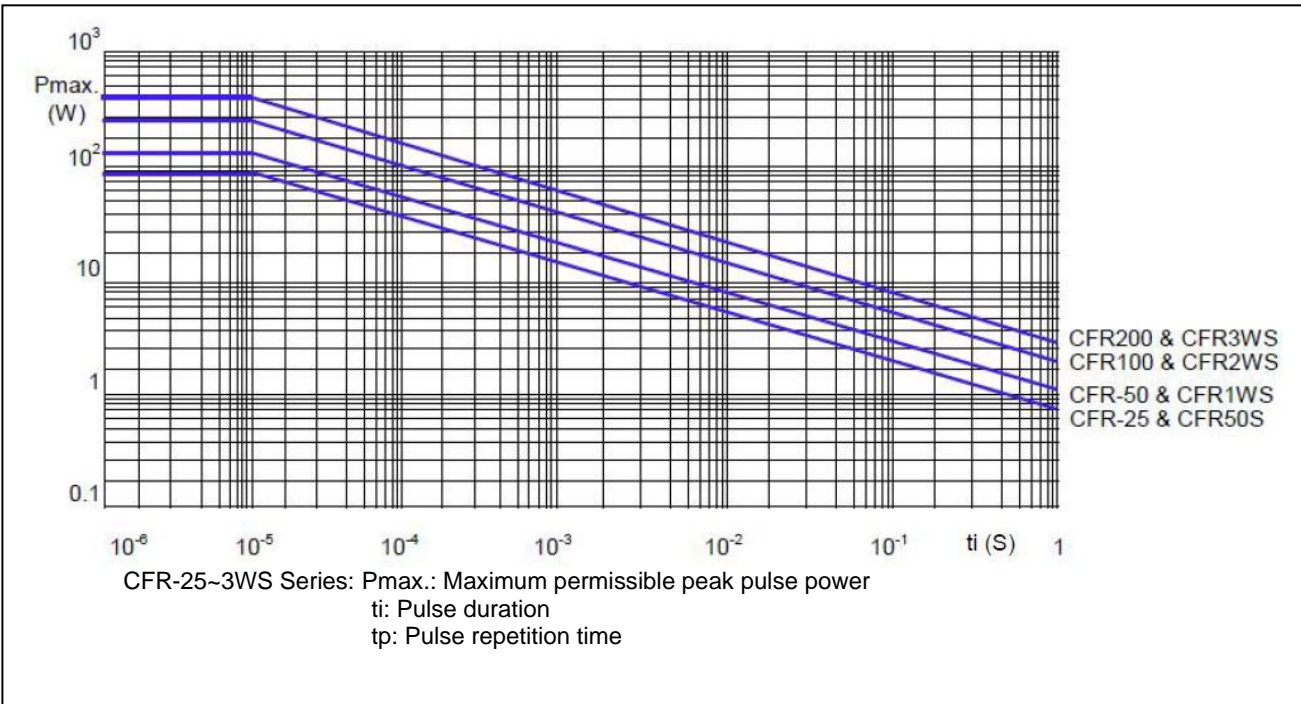

AXIAL / REEL TAPE SPECIFICATION

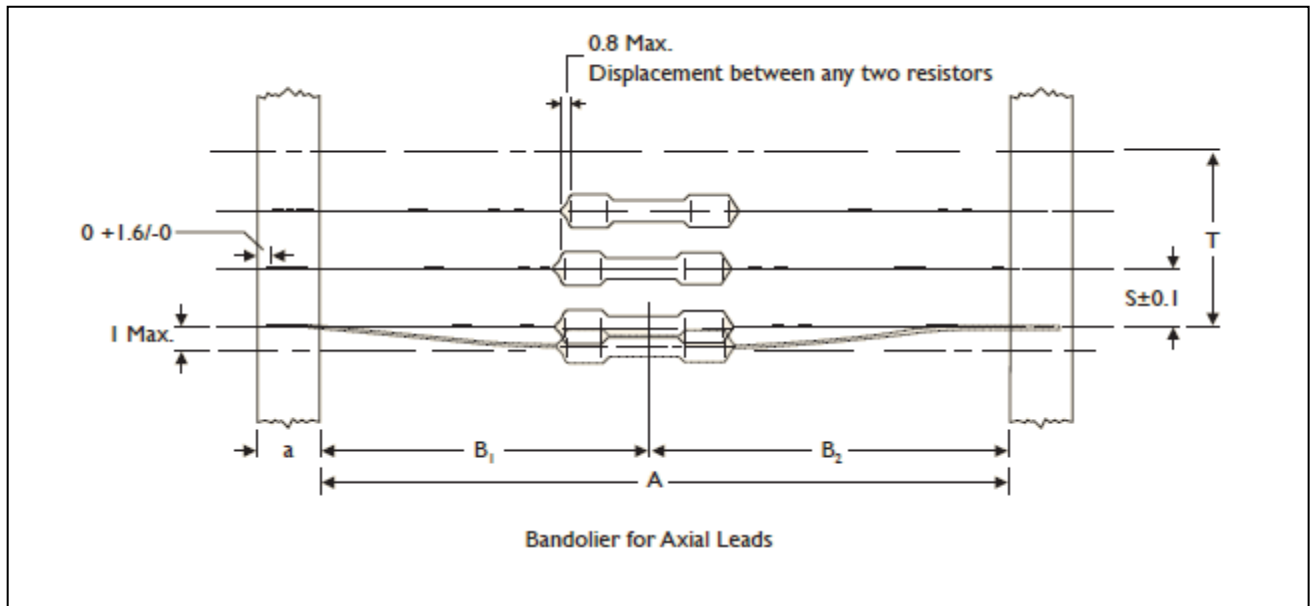

Unit: mm

Normal	Miniature	a	A	B1-B2 (Max.)	S (spacing)	T (max. deviation of spacing)
CFR-12	CFR25S	6 ± 0.5	52.4 ± 1.5	1.2	5	1 mm per 10 spacing, 0.5 mm per 5 spacing
			26.0 ± 1.5	1.0		
CFR-25	CFR50S	6 ± 0.5	52.4 ± 1.5	1.2	5	
			26.0 ± 1.5	1.0		
CFR-50	CFR1WS	6 ± 0.5	52.4 ± 1.5	1.2	5	
CFR100	CFR2WS	6 ± 0.5	73.0 ± 1.5	1.5	5	
			52.4 ± 1.5	1.2		
CFR200	CFR3WS	6 ± 0.5	73.0 ± 1.5	1.5	10	
			52.4 ± 1.5	1.2		

TAPE ON REEL PACKING

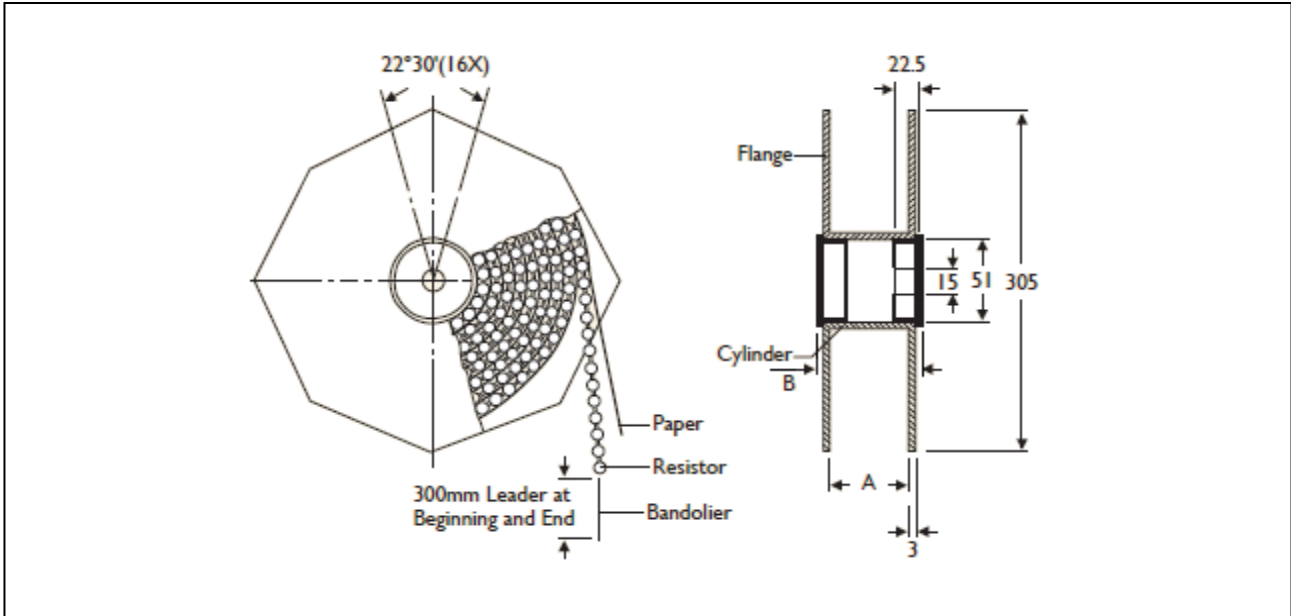

Unit: mm/piece

TYPE	Normal	Miniature	Across Flange(A)	B	Quantity Per Reel
CFR-12		CFR25S	66.5	75.5	5,000
CFR-25		CFR50S	66.5	75.5	5,000
CFR-50		CFR1WS	66.5	75.5	2,500
CFR100		CFR2WS	87	96	2,000
CFR200		CFR3WS	87	96	1,000

TAPE ON BOX PACKING

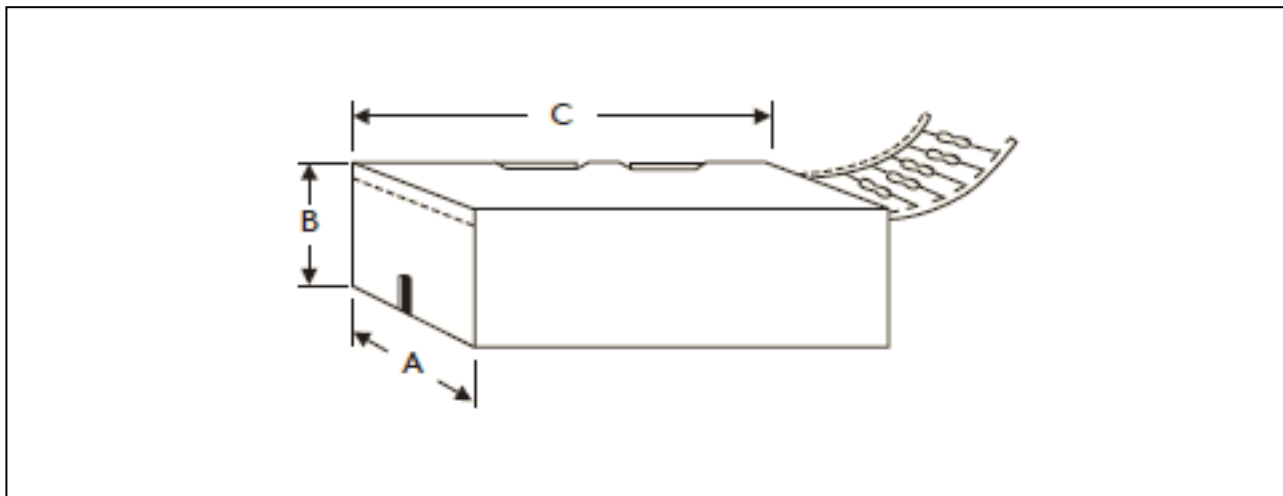

TYPE		DIMENSIONS			Unit: mm/piece
Normal	Miniature	A	B	C	Quantity Per Box
CFR-12	CFR25S	48	102	255	5,000
CFR-12	CFR25S	81	70	260	5,000
CFR-25	CFR50S	48	102	255	5,000
CFR-25	CFR50S	81	104	260	5,000
CFR-50	CFR1WS	73	45	258	1,000
CFR100	CFR2WS	81	91	260	1,000
CFR100	CFR2WS	103	78	260	1,000
CFR200	CFR3WS	81	91	260	1,000
CFR200	CFR3WS	103	94	260	1,000

BULK PACKING

Normal	Miniature	Piece/Per Inner Box	Bag/Per Inner Box	Piece Per Bag
CFR-12	CFR25S	10,000	10	1,000
CFR-25	CFR50S	10,000	10	1,000
CFR-50	CFR1WS	5,000	5	1,000
CFR-100	CFR2WS	2,000	4	500
CFR200	CFR3WS	1,000	2	500

FORMING

M TYPE

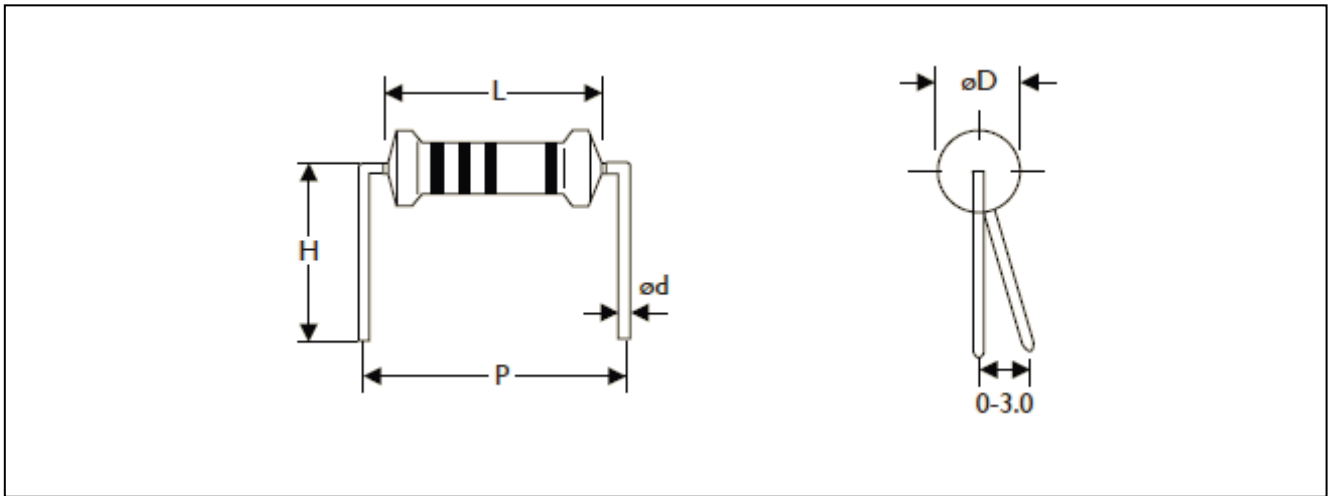

TYPE		DIMENSIONS					Unit: mm	
Normal	Miniature	L	ψD	ψd	P	H		
CFR-12	CFR25S	3.4 ± 0.3	1.9 ± 0.2	0.45 ± 0.05	6.0 ± 1	10.0 ± 1		
CFR-25	CFR50S	6.3 ± 0.5	2.4 ± 0.2	0.55 ± 0.05	10.0 ± 1	10.0 ± 1		
CFR-50	CFR1WS	9.0 ± 0.5	3.3 ± 0.3	0.55 ± 0.05	12.5 ± 1	10.0 ± 1		
CFR100	CFR2WS	11.5 ± 1.0	4.5 ± 0.5	0.8 ± 0.05	15.0 ± 1	12.5 ± 1		
CFR200	CFR3WS	15.5 ± 1.0	5.0 ± 0.5	0.8 ± 0.05	20.0 ± 1	15.0 ± 1		

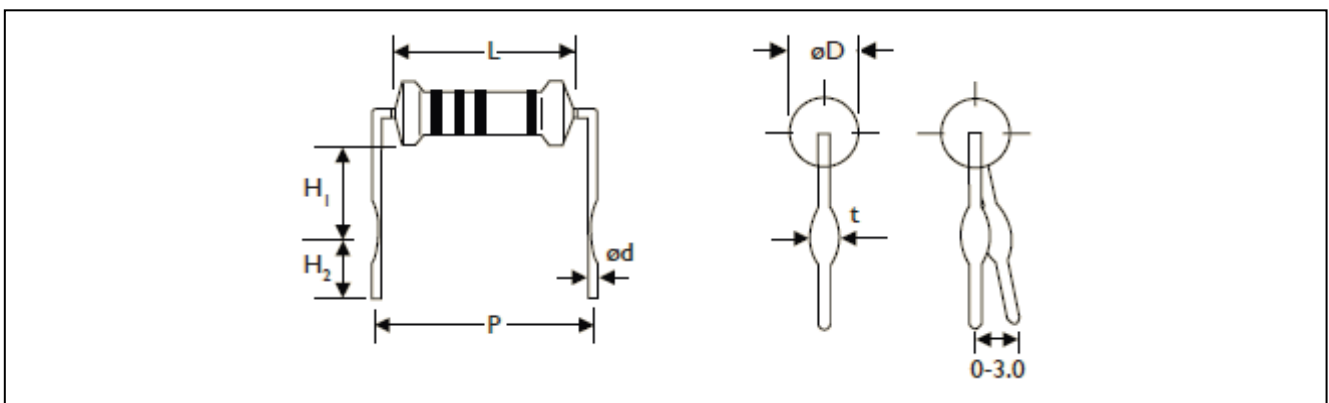

MB TYPE

TYPE		DIMENSIONS							Unit: mm	
Normal	Miniature	L	ψD	ψd	P	H1	H2	t		
CFR-25	CFR50S	6.3 ± 0.5	2.4 ± 0.2	0.55 ± 0.05	10.0 ± 1	6.0 ± 1	5.0 ± 1	1.2 ± 0.2		
CFR-50	-	9.0 ± 0.5	3.3 ± 0.3	0.55 ± 0.05	12.5 ± 1	6.0 ± 1	5.0 ± 1	1.2 ± 0.2		
-	CFR1WS	9.0 ± 0.5	3.3 ± 0.3	0.8 ± 0.05	12.5 ± 1	6.0 ± 1	5.0 ± 1	1.4 ± 0.2		
CFR100	CFR2WS	11.5 ± 1.0	4.5 ± 0.5	0.8 ± 0.05	15.0 ± 1	6.0 ± 1	5.0 ± 1	1.4 ± 0.2		
CFR200	CFR3WS	15.5 ± 1.0	5.0 ± 0.5	0.8 ± 0.05	20.0 ± 1	10.0 ± 1	5.0 ± 1	1.4 ± 0.2		

MHA TYPE

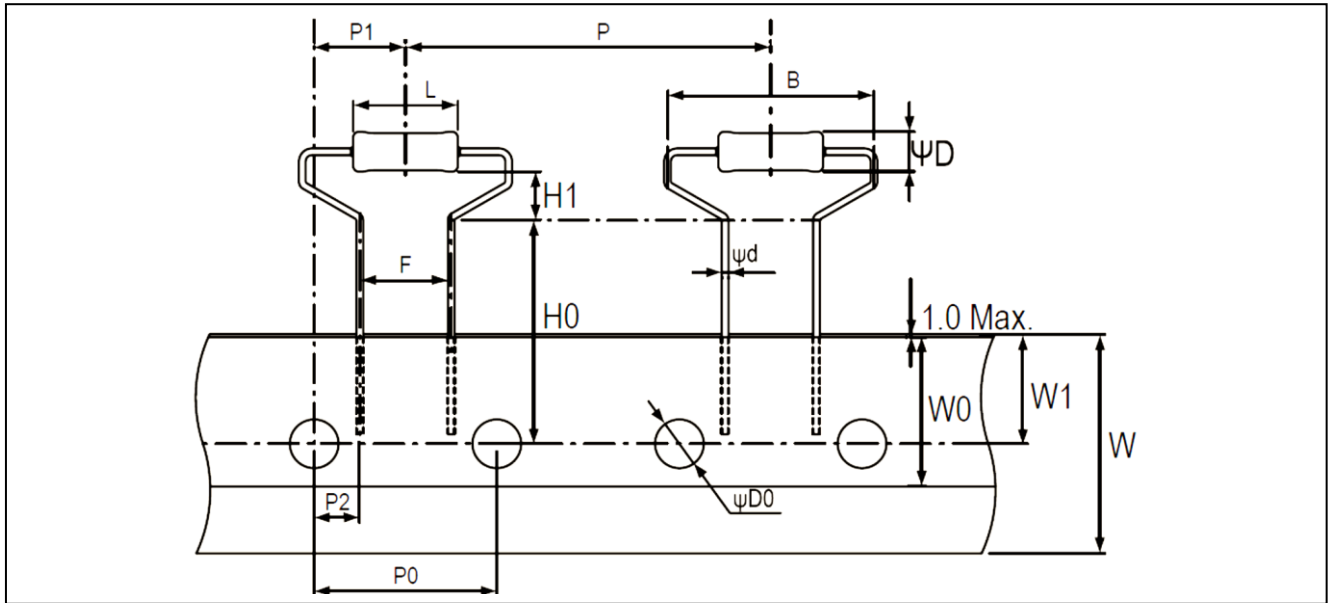

TYPE		DIMENSIONS								Unit: mm
Normal	Miniature	L	ψD	ψd	B	H0	H1	P	P0	
		9.0±0.5	3.3±0.3	0.55±0.05	17.5Max	19.0±1.0	4.0±1.0	30.0±1.0	15.0±0.3	
CFR-50	CFR1WS	P1	P2	F	W	W0	W1	$\psi D0$		
		7.5±1.0	3.75±0.5	7.5±0.5	18.0±0.5	5.0Min	9.0±0.5	4.0±0.2		

MHB TYPE

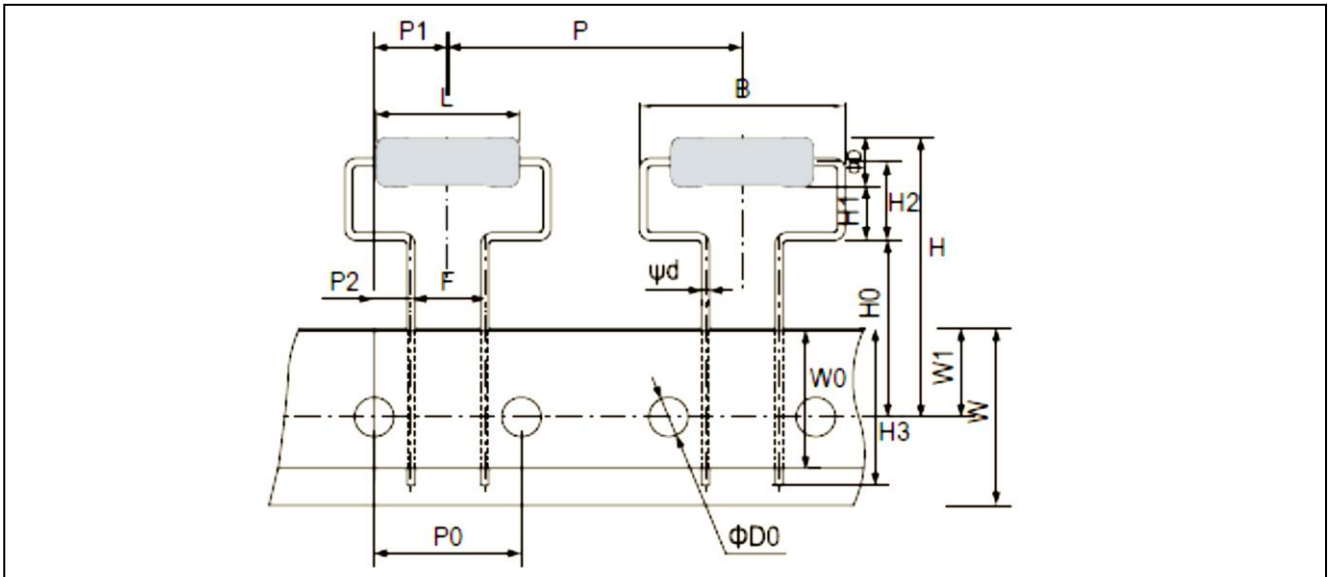

TYPE		DIMENSIONS								Unit: mm
Normal	Miniature	L	ψD	ψd	B	H	H0	H1	H2	H3
		15.5±1.0	5.0±0.5	0.8±0.05	21.0Max.	30Max.	18.0±1.0	5.5(Ref.)	8.0±1.5	16Max.
CFR200	CFR3WS	P	P0	P1	P2	F	W	W0	W1	ψD0
		30.0±1.0	15.0±0.3	7.5±1.0	3.75±0.8	7.5±0.5	18.0±0.5	5.0Min.	9.0±0.5	4.0±0.3

MHC TYPE

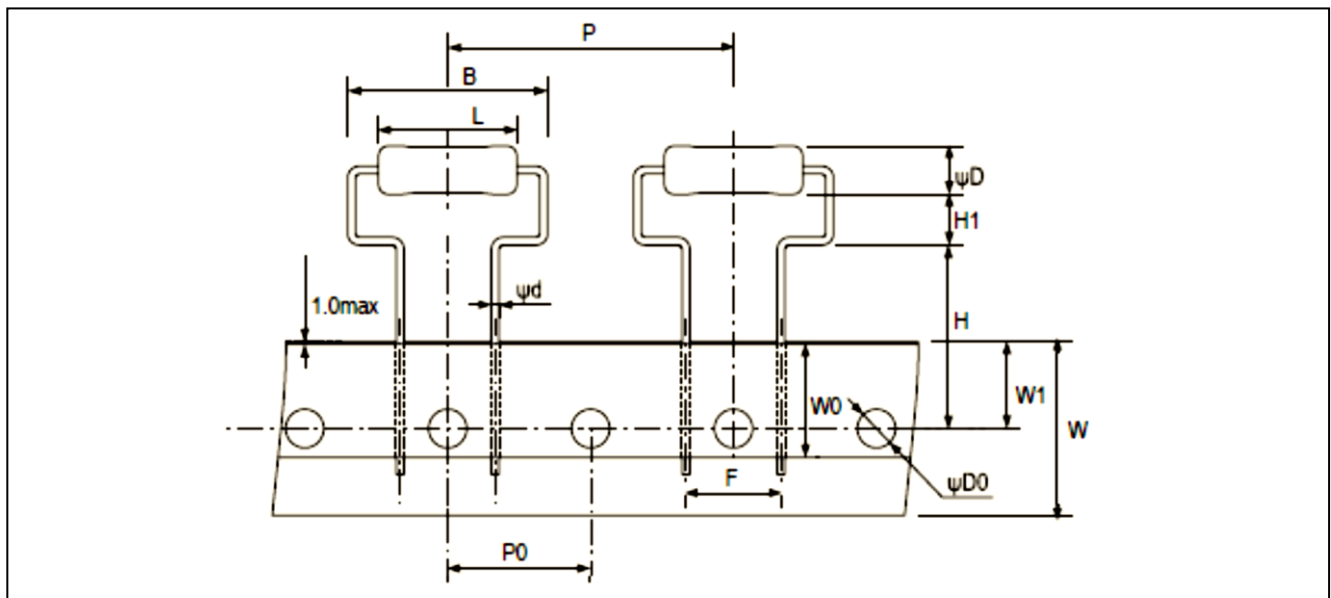

TYPE		DIMENSIONS								Unit: mm
Normal	Miniature	L	ψD	ψd	B	H	H1	P	P0	
		15.5±1.0	5.0±0.5	0.8±0.05	21.0Max.	19.0±1.0	5.25±1.0	30.0±1.0	15.0±0.3	
CFR200	CFR3WS	F	W	W0	W1	ψD0				
		10.0±0.5	18.0±0.5	5.0Min.	9.0±0.5	4.0±0.2				

F TYPE

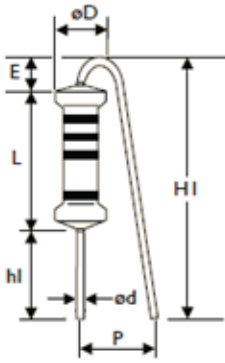

FK TYPE

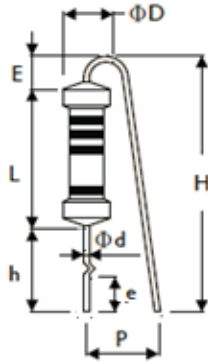

FFK TYPE

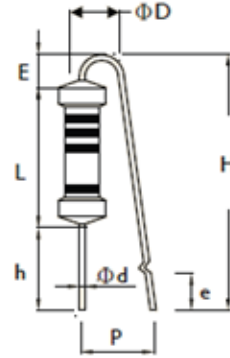

FFK TYPE

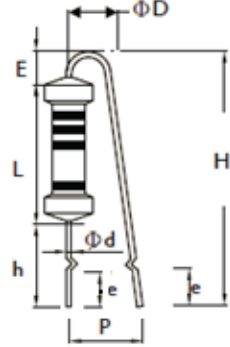

TYPE		DIMENSIONS										Unit: mm
Normal	Miniature	L	ψD	ψd	P	h	H Max.	hI	HI Max.	E Max.	e	
CFR-50	CFR1WS	9.0±0.5	3.3±0.3	0.55±0.05	6±1	8±1	22	5±1	18.5	3.5	3.5±1	
CFR100	CFR2WS	11.5±1	4.5±0.5	0.8±0.05	6±1	8±1	24	5±1	20	3.5	3.5±1	
CFR200	CFR3WS	15.5±1	5.0±0.5	0.8±0.05	8±1	8±1	28	5±1	25	3.5	3.5±1	

FB- TYPE (for -25&50S)

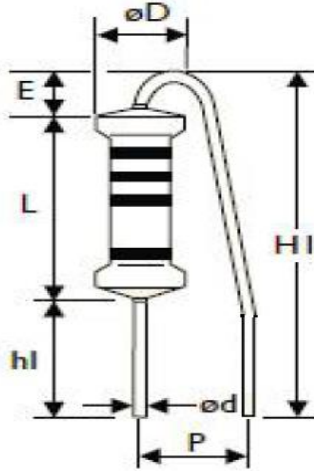

TYPE		DIMENSIONS							Unit: mm
Normal	Miniature	L	ψD	ψd	P	hI	HI	E Max.	
CFR-25	CFR50S	6.3 ± 0.5	2.4 ± 0.2	0.55 ± 0.05	6±1	5.5±0.5	13.5±0.5	3.5	

FT TYPE (Taping Pack)

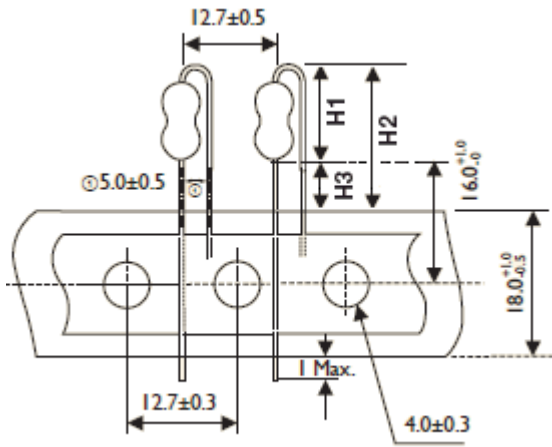

MT TYPE (Taping Pack)

Rated Watts : 1/6W,1/4WS

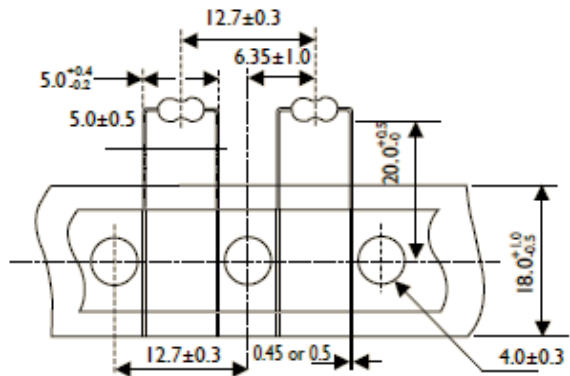

TYPE		DIMENSIONS			Unit: mm
Normal	Miniature	H1 Max.	H2 Max.	H3 Max.	
CFR-25	CFR50S	10	18.5	8.5	
CFR-50	CFR1WS	13	21.5	8.5	
CFR100	CFR2WS	16	24.5	8.5	

PN TYPE (Taping Pack)

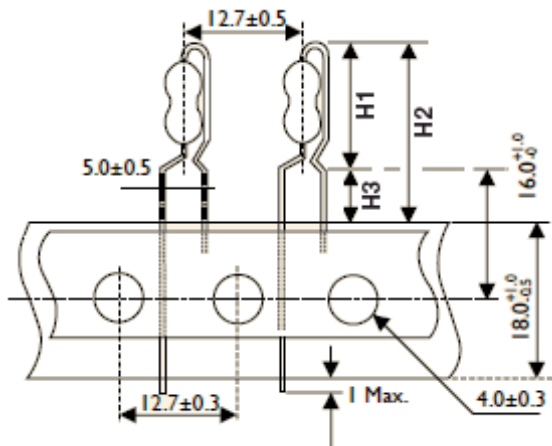

AV TYPE (Taping Pack)

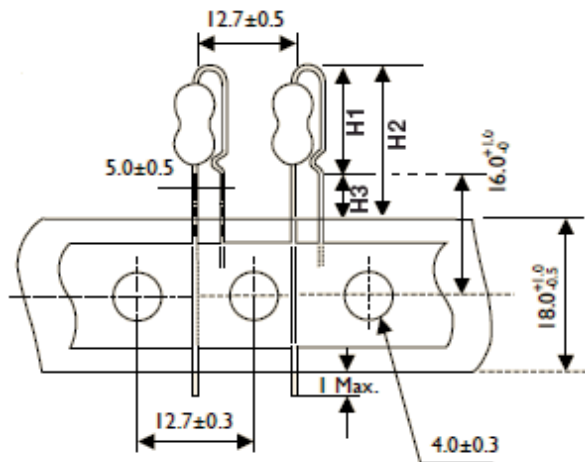

TYPE		DIMENSIONS			Unit: mm
Normal	Miniature	H1 Max.	H2 Max.	H3 Max.	
CFR-25	CFR50S	13	21.5	8.5	
CFR-50	CFR1WS	17	25.5	8.5	
CFR100	CFR2WS	19	27.5	8.5	

TYPE		DIMENSIONS			Unit: mm
Normal	Miniature	H1 Max.	H2 Max.	H3 Max.	
CFR-25	CFR50S	11.5	20	8.5	
CFR-50	CFR1WS	14.5	23	8.5	
CFR100	CFR2WS	17.5	26	8.5	

MARKING



COLOR	1st BAND	2nd BAND	3rd BAND	MULTIPLIER	TOLERANCE
BLACK	0	0	0	1Ω	
BROWN	1	1	1	10Ω	
RED	2	2	2	100Ω	± 2% (G)
ORANGE	3	3	3	1KΩ	
YELLOW	4	4	4	10KΩ	
GREEN	5	5	5	100K	
BLUE	6	6	6	1MΩ	
VIOLET	7	7	7	10MΩ	
GREY	8	8	8	0.001Ω	
WHITE	9	9	9	0.0001Ω	
GOLD				0.1Ω	± 5 % (J)
SILVER				0.01Ω	

REVISION HISTORY

REVISION	DATE	CHANGE NOTIFICATION	DESCRIPTION
Version 3	Apr.2, 2024	-	- Added forming code description for part number
Version 2	Aug.31, 2023	-	- Updated legal disclaimer and footer versions numbers
Version 1	Aug.31, 2021	-	- Add FB- forming code to -25&50S
Version 0	Aug.2, 2021	-	- First issue of this specification

“ Yageo reserves all the rights for revising the content of this datasheet without further notification, as long as the products itse lf are unchanged. Any product change will be announced by PCN.”

LEGAL DISCLAIMER

YAGEO, its distributors and agents (collectively, "YAGEO"), hereby disclaims any and all liabilities for any errors, inaccuracies or incompleteness contained in any product related information, including but not limited to product specifications, datasheets, pictures and/or graphics. YAGEO may make changes, modifications and/or improvements to product related information at any time and without notice.

YAGEO makes no representation, warranty, and/or guarantee about the fitness of its products for any particular purpose or the continuing production of any of its products. To the maximum extent permitted by law, YAGEO disclaims (i) any and all liability arising out of the application or use of any YAGEO product, (ii) any and all liability, including without limitation special, consequential or incidental damages, and (iii) any and all implied warranties, including warranties of fitness for a particular purpose, non-infringement and merchantability.

YAGEO products are designed for general purpose applications under normal operation and usage conditions. Please contact YAGEO for the applications listed below which require especially high reliability for the prevention of defects which might directly cause damage to the third party's life, body or property: Aerospace equipment (artificial satellite, rocket, etc.), Atomic energy-related equipment, Aviation equipment, Disaster prevention equipment, crime prevention equipment, Electric heating apparatus, burning equipment, Highly public information network equipment, data-processing equipment, Medical devices, Military equipment, Power generation control equipment, Safety equipment, Traffic signal equipment, Transportation equipment and Undersea equipment, or for any other application or use in which the failure of YAGEO products could result in personal injury or death, or serious property damage. Particularly **YAGEO Corporation and its affiliates do not recommend the use of commercial or automotive grade products for high reliability applications or manned space flight.**







Information provided here is intended to indicate product specifications only. YAGEO reserves all the rights for revising this content without further notification, as long as products are unchanged. Any product change will be announced by PCN.

Looking for pricing, stock, or lifecycle information?

Click below to explore more details on WIN SOURCE:

-  [View CFR-25JT-52-1K2 on WIN SOURCE](#)
-  [Yageo Information](#)

Optimize Your Supply Chain with WIN SOURCE Solutions

-  Global Sourcing Solution
-  Obsolete Management
-  Cost Control Management
-  Shortage Management
-  Alternative Solution
-  Excess Inventory Management