



THE DATASHEET OF HMC424A-SX



FEATURES

Attenuation range: 0.5 dB (LSB) steps to 31.5 dB

±0.5 dB typical step error

Low insertion loss: 2.8 dB typical at 4.0 GHz

High linearity at $V_{EE} = -5$ V

Input P0.1dB: 25 dBm typical

Input IP3: 45 dBm typical

High RF input power handling: 25 dBm maximum

Low relative phase: 30° at 6.0 GHz

Single-supply operation: -3 V to -5 V

Die size: 1.390 mm × 0.770 mm × 0.102 mm

APPLICATIONS

Cellular infrastructure

Microwave radios and very small aperture terminals (VSATs)

Test equipment and sensors

Intermediate frequency (IF) and RF designs

Military and space

GENERAL DESCRIPTION

The HMC424ACHIPS is a broadband, 6-bit, gallium arsenide (GaAs), digital attenuator monolithic microwave integrated circuit (MMIC) chip with a 31.5 dB attenuation control range in 0.5 dB steps.

The HMC424ACHIPS offers excellent attenuation accuracy of $\pm(0.2 \text{ dB} + 3\% \text{ of attenuation state})$ and high input linearity over the specified frequency range from 0.1 GHz to 13.0 GHz with a typical insertion loss of ≤ 4.2 dB. The attenuator bit values are 0.5 dB (LSB), 1 dB, 2 dB, 4 dB, 8 dB, and 16 dB for a total attenuation of 31.5 dB with a ± 0.5 dB of typical step error.

FUNCTIONAL BLOCK DIAGRAM

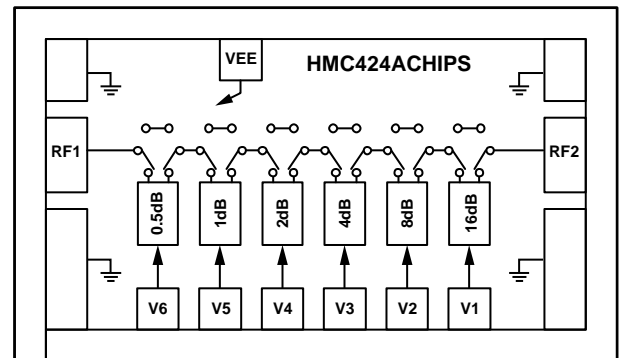

Figure 1.

13870-001

The device allows a user to program the attenuation state via six parallel control inputs toggled between 0 V and V_{EE} .

The HMC424ACHIPS operates with a single negative supply voltage from -3 V to -5 V, and requires an external driver to interface with a CMOS/transistor to transistor logic (TTL) interface.

The HMC424ACHIPS comes in a RoHS compliant, 9-pad bare die.

TABLE OF CONTENTS

Features 1
 Applications..... 1
 Functional Block Diagram 1
 General Description 1
 Revision History 2
 Specifications..... 3
 Absolute Maximum Ratings..... 4
 Thermal Resistance 4
 ESD Caution..... 4
 Pin Configuration and Function Descriptions..... 5
 Interface Schematics..... 5
 Typical Performance Characteristics 6

Insertion Loss, Return Loss, State Error, Step Error, and
 Relative Phase6
 Input Power Compression and Third-Order Intercept.....8
 Theory of Operation9
 Power Supply.....9
 RF Input and Output9
 Applications Information 10
 Mounting and Bonding Techniques 10
 Assembly Diagram 10
 Outline Dimensions 11
 Ordering Guide 11

REVISION HISTORY

3/2020—Rev. 01.1115 to Rev. B

This Hittite Microwave Products data sheet has been reformatted to meet the styles and standards of Analog Devices, Inc.

Changes to Title, Features Section, Applications Section, and
 General Description Section 1
 Changes to Table 1 3
 Added Table 2, Figure 2, Thermal Resistance Section, and
 Table 3; Renumbered Sequentially 4
 Changes to Table 2 4
 Deleted Bias Voltage & Current Table and Control Voltage
 Table; Renumbered Sequentially 5
 Added Figure 3, Table 4, and Figure 4 5
 Changes to Figure 5 5
 Added Insertion Loss, Return Loss, State Error, Step Error, and
 Relative Phase Section, Figure 8, Figure 9, and Figure 12 6
 Changes to Figure 7, Figure 10, and Figure 11 6
 Added Figure 13, Figure 14, and Figure 16 7
 Changes to Figure 15 7

Deleted Handling Precautions Section, Mounting Section, and
 Wire Bonding Section7
 Added Input Power Compression and Third-Order Intercept
 Section, Figure 18 to Figure 20, and Figure 228
 Changes to Figure 17 and Figure 218
 Added Theory of Operation Section, Power Supply Section, and
 RF Input and Output Section.....9
 Changes to Figure 23.....9
 Added Applications Information Section 10
 Changed Mounting & Bonding Techniques for Millimeterwave
 GaAs MMICs Section to Mounting and Bonding Techniques
 Section..... 10
 Changes to Mounting and Bonding Techniques Section,
 Figure 24, and Figure 25 10
 Updated Outline Dimensions 11
 Changes to Ordering Guide 11

SPECIFICATIONS

Supply voltage (V_{EE}) = -3 V to -5 V, control input voltage (V_{CTL}) = 0 V or V_{EE} , T_{CASE} = 25°C, 50 Ω system, unless otherwise noted.

Table 1.

Parameter	Symbol	Test Conditions/Comments	Min	Typ	Max	Unit
FREQUENCY RANGE			0.1		13.0	GHz
INSERTION LOSS	IL	0.1 GHz to 4.0 GHz 4.0 GHz to 8.0 GHz 8.0 GHz to 13.0 GHz		2.8 3.4 4.2	3.3 4.0 4.6	dB dB dB
ATTENUATION		0.1 GHz to 13.0 GHz				
Range		Between minimum and maximum attenuation states		31.5		dB
Step Size		Between any successive attenuation states		0.5		dB
Step Error		Between any successive attenuation states		± 0.5		dB
State Error		All attenuation states, referenced to insertion loss state				
		0.1 GHz to 8.0 GHz	$-(0.2 + 3\%$ of attenuation state)		$+(0.2 + 3\%$ of attenuation state)	dB
		8.0 GHz to 13.0 GHz	$-(0.2 + 4\%$ of attenuation state)		$+(0.2 + 4\%$ of attenuation state)	dB
RETURN LOSS (RF1 AND RF2)		All attenuation states, 0.1 GHz to 13.0 GHz		12		dB
RELATIVE PHASE		Between minimum and maximum attenuation states				
		0.1 GHz to 6.0 GHz		30		Degrees
		6.0 GHz to 13.0 GHz		70		Degrees
SWITCHING CHARACTERISTICS		Between all attenuation states				
Rise and Fall Time	t_{RISE}, t_{FALL}	10% to 90% of RF output		30		ns
On and Off Time	t_{ON}, t_{OFF}	50% V_{CTL} to 90% of RF output		50		ns
INPUT LINEARITY ¹		All attenuation states, 500 MHz to 6.0 GHz				
0.1 dB Compression	P0.1dB	$V_{EE} = -3$ V $V_{EE} = -5$ V		23 25		dBm dBm
Third-Order Intercept	IP3	$V_{EE} = -5$ V, 10 dBm per tone, 1 MHz spacing $V_{EE} = -3$ V, 10 dBm per tone, 1 MHz spacing		45 35		dBm dBm
SUPPLY CURRENT	I_{DD}	$V_{EE} = -3$ V to -5 V		2	5	mA
DIGITAL CONTROL INPUTS		V1 to V6				
Voltage						
Low	V_{INL}	$V_{EE} = -3$ V $V_{EE} = -5$ V	-1.0 -3.0		0 0	V V
High	V_{INH}	$V_{EE} = -3$ V $V_{EE} = -5$ V	-3.0 -5.0		-2.2 -4.2	V V
Current		$V_{EE} = -3$ V to -5 V				
Low	I_{INL}			35		μ A
High	I_{INH}			1		μ A

¹ Input linearity performance degrades at frequencies less than 250 MHz; see Figure 17, Figure 21, and Figure 22.

ABSOLUTE MAXIMUM RATINGS

Table 2.

Parameter	Rating
Supply Voltage, V_{EE}	-7 V
Digital Control Input Voltage	$V_{EE} - 0.5$ V
RF Input Power ¹ (All Attenuation States, f = 0.8 to 13.0 GHz, $T_{CASE} = 85^{\circ}\text{C}$, $V_{EE} = -3$ V to -5 V)	25 dBm
Continuous Power Dissipation, P_{DISS} ($T_{CASE} = 85^{\circ}\text{C}$)	0.56 W
Temperature	
Junction, T_J	150°C
Storage	-65°C to +150°C
ESD Sensitivity, Human Body Model (HBM)	250 V (Class 1A)

¹ For power derating at frequencies less than 800 MHz, see Figure 2.

Stresses at or above those listed under Absolute Maximum Ratings may cause permanent damage to the product. This is a stress rating only; functional operation of the product at these or any other conditions above those indicated in the operational section of this specification is not implied. Operation beyond the maximum operating conditions for extended periods may affect product reliability.

Only one absolute maximum rating can be applied at any one time.

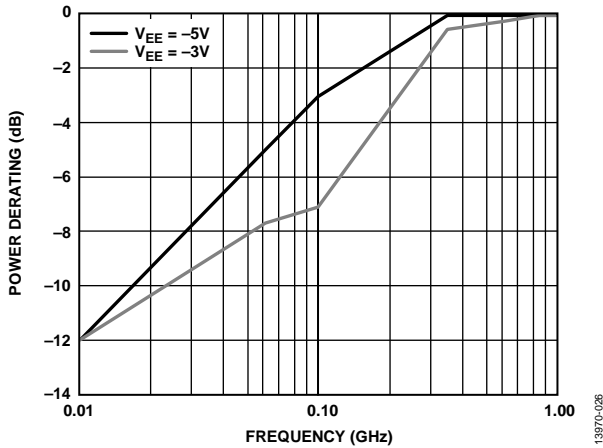

Figure 2. Power Derating at Frequencies Less than 0.8 GHz

THERMAL RESISTANCE

Thermal performance is directly linked to printed circuit board (PCB) design and operating environment. Careful attention to PCB thermal design is required.

θ_{JC} is the junction to case thermal resistance.

Table 3. Thermal Resistance

Package Type	θ_{JC}	Unit
C-9-2 ¹	330	°C/W

¹ Thermal impedance simulated values are based on a JEDEC 2S2P thermal test board with nine thermal vias. See JEDEC JESD51.

ESD CAUTION



ESD (electrostatic discharge) sensitive device.

Charged devices and circuit boards can discharge without detection. Although this product features patented or proprietary protection circuitry, damage may occur on devices subjected to high energy ESD. Therefore, proper ESD precautions should be taken to avoid performance degradation or loss of functionality.

PIN CONFIGURATION AND FUNCTION DESCRIPTIONS

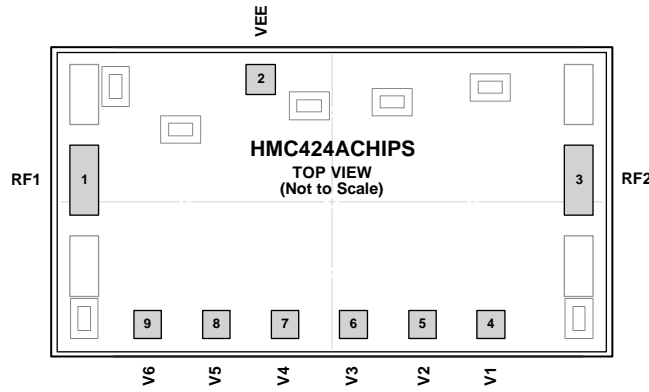

Figure 3. Pin Configuration

Table 4. Pin Function Descriptions

Pad No.	Mnemonic	Description
1	RF1	Attenuator RF Input. This pin is dc-coupled and ac matched to 50 Ω. An external dc blocking capacitor is required if the RF line potential is not equal to 0 V.
2	VEE	Power Supply.
3	RF2	Attenuator RF Output. This pin is dc-coupled and ac matched to 50 Ω. An external dc blocking capacitor is required if the RF line potential is not equal to 0 V.
4 to 9	V1 to V6	Parallel Control Voltage Inputs. These pins select the required attenuation (see Table 5). There is an internal pull-down resistor on these pins to V _{EE} .

INTERFACE SCHEMATICS

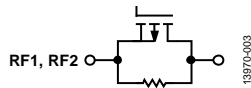

Figure 4. RF1 and RF2 Interface Schematic

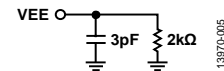

Figure 6. VEE Interface Schematic

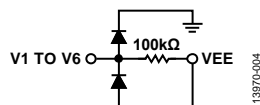

Figure 5. V1 to V6 Interface Schematic

TYPICAL PERFORMANCE CHARACTERISTICS

INSERTION LOSS, RETURN LOSS, STATE ERROR, STEP ERROR, AND RELATIVE PHASE

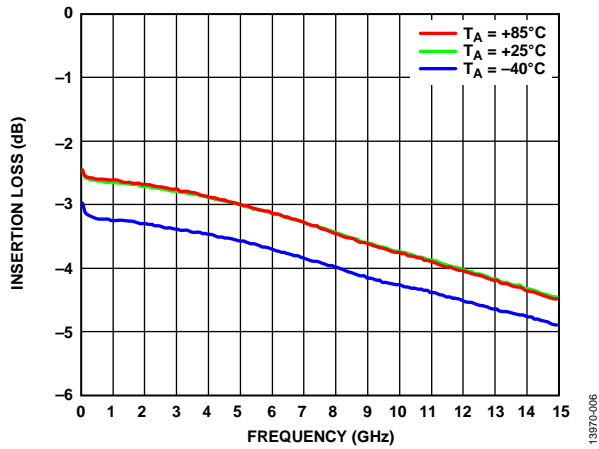

Figure 7. Insertion Loss vs. Frequency over Temperature

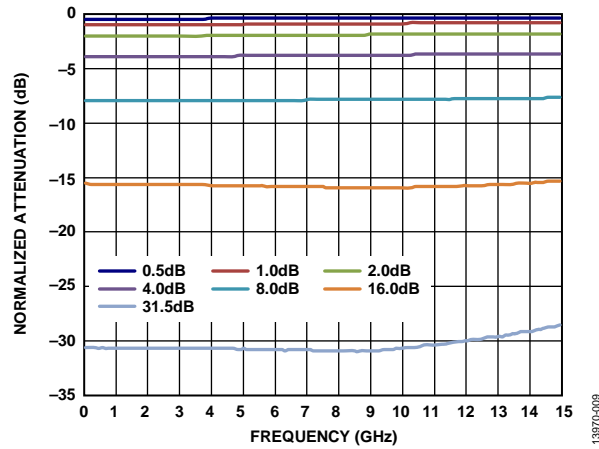

Figure 10. Normalized Attenuation vs. Frequency over Major Attenuation States

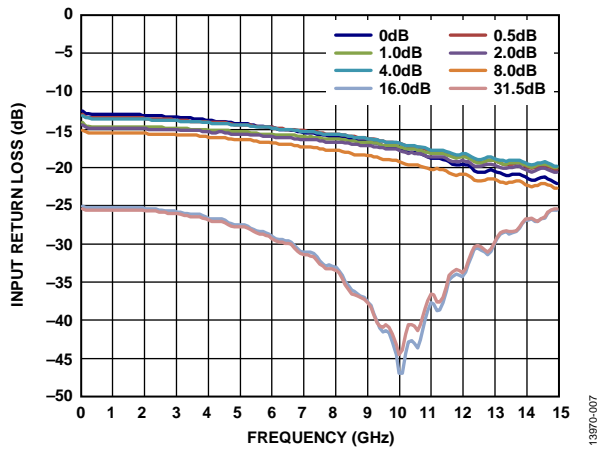

Figure 8. Input Return Loss vs. Frequency over Major Attenuation States

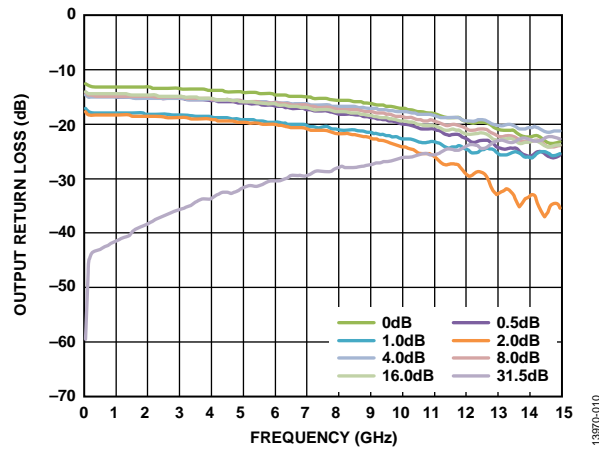

Figure 11. Output Return Loss vs. Frequency over Major Attenuation States

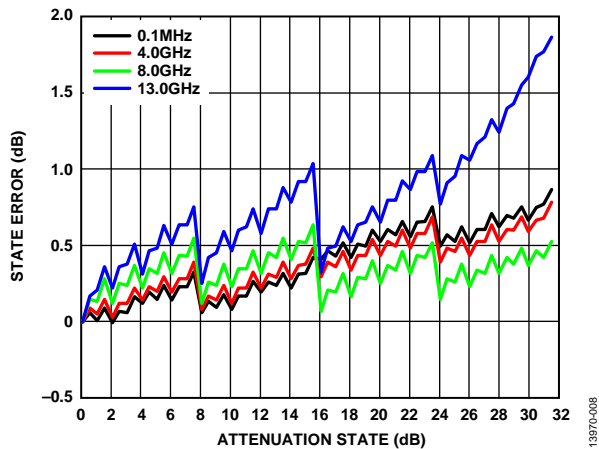

Figure 9. State Error vs. Attenuation State over Frequency

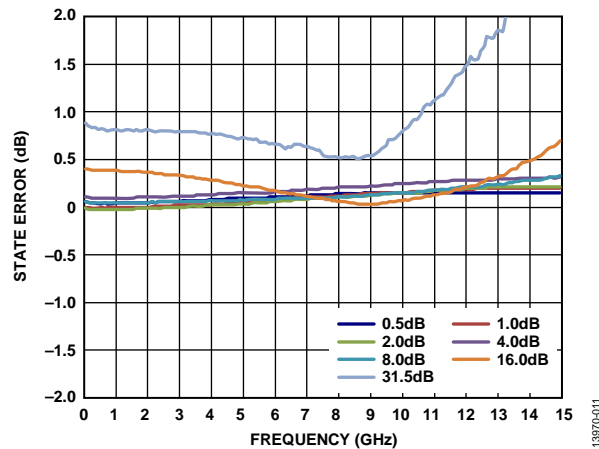

Figure 12. State Error vs. Frequency over Major Attenuation States

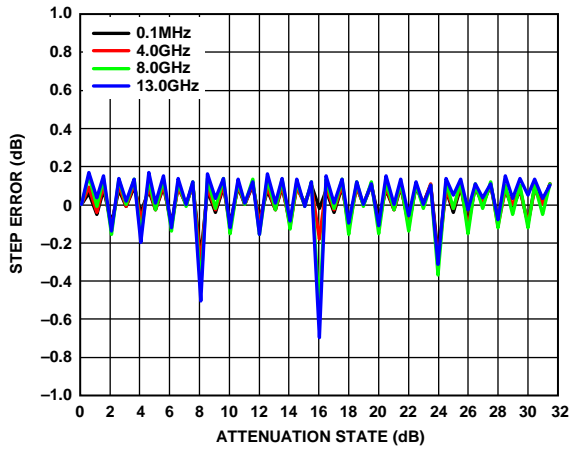

Figure 13. Step Error vs. Attenuation State over Frequency

13970-012

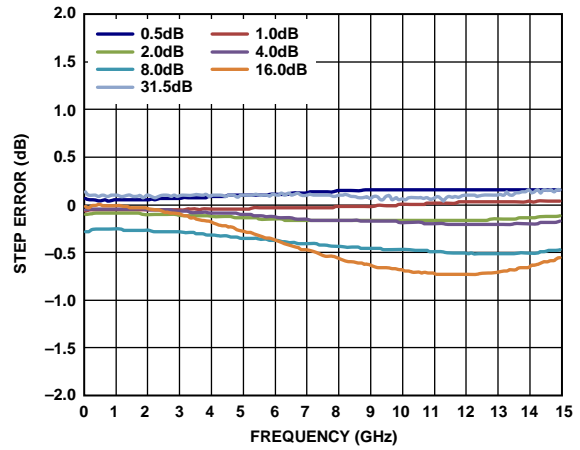

Figure 15. Step Error vs. Frequency over Major Attenuation States

13970-014

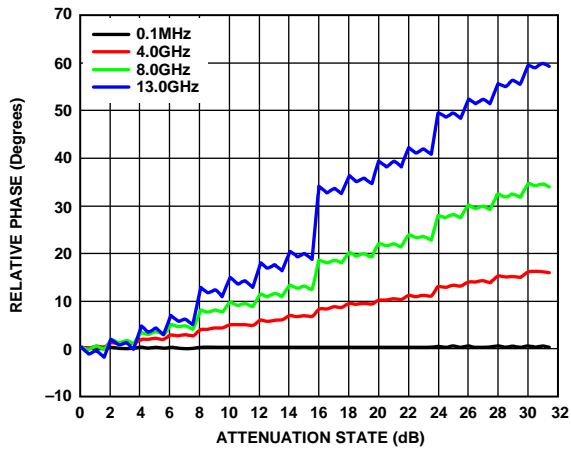

Figure 14. Relative Phase vs. Attenuation State over Frequency

13970-013

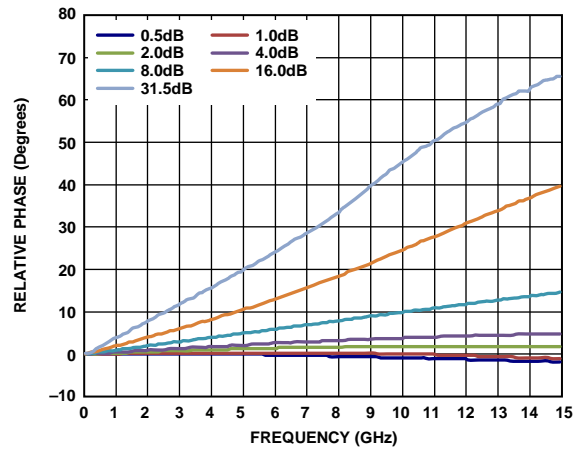

Figure 16. Relative Phase vs. Frequency over Major Attenuation States

13970-015

INPUT POWER COMPRESSION AND THIRD-ORDER INTERCEPT

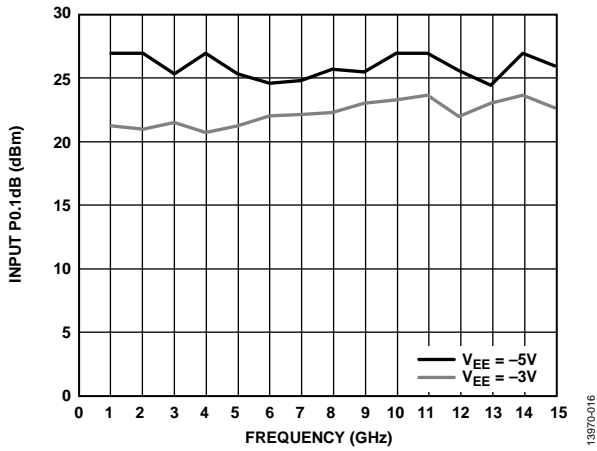

Figure 17. Input P0.1dB vs. Frequency at Minimum Attenuation State over $V_{EE} = -5V$ and $V_{EE} = -3V$

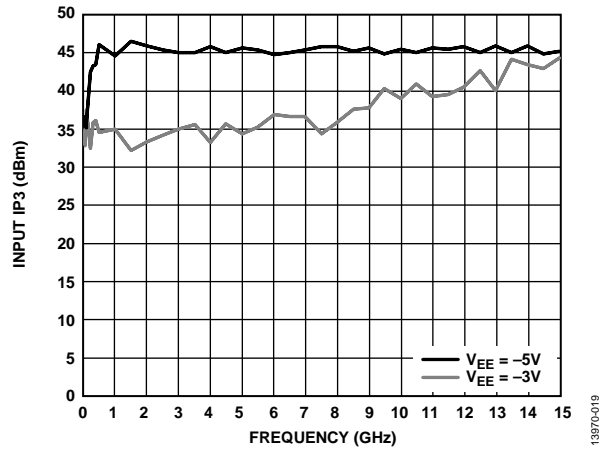

Figure 20. Input IP3 vs. Frequency at Minimum Attenuation State over $V_{EE} = -5V$ and $V_{EE} = -3V$

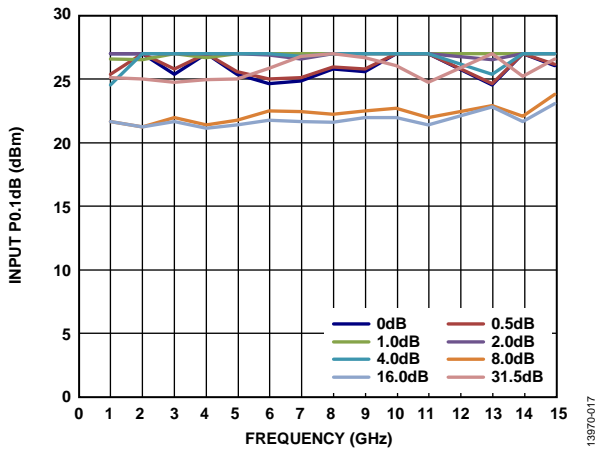

Figure 18. Input P0.1dB vs. Frequency over Major Attenuation States, $V_{EE} = -5V$

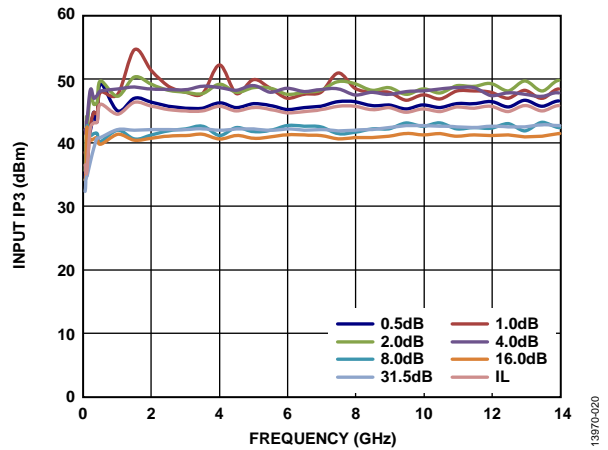

Figure 21. Input IP3 vs. Frequency over Major Attenuation States, $V_{EE} = -5V$

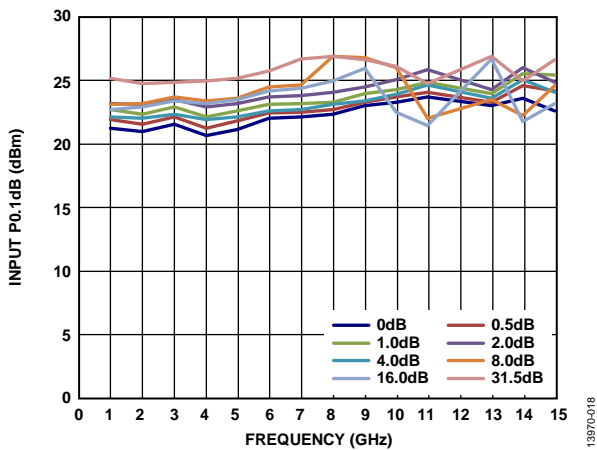

Figure 19. Input P0.1dB vs. Frequency over Major Attenuation States, $V_{EE} = -3V$

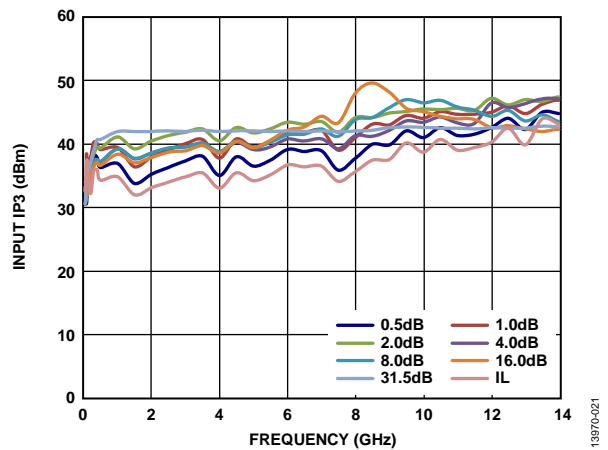

Figure 22. Input IP3 vs. Frequency over Major Attenuation States, $V_{EE} = -3V$

THEORY OF OPERATION

The HMC424ACHIPS incorporates a 6-bit attenuator die that offers an attenuation range of 31.5 dB in 0.5 dB steps. The attenuation state is changed by the parallel control voltage inputs (V1 to V6) directly (see Table 5).

The HMC424ACHIPS allows the user to program the attenuation state via six parallel control inputs toggled between 0 V and V_{EE} . When interfacing with a TTL/CMOS interface, an external level shifter is required. An example simple driver using standard logic ICs provides fast switching while using minimum dc current. The series resistance is recommended to suppress unwanted RF signals at the input of the V1 to V6 control lines.

POWER SUPPLY

The HMC424ACHIPS requires a single dc voltage applied to the VEE pin. The ideal power-up sequence is as follows:

1. Connect the ground reference.
2. Apply a supply voltage to the VEE pin.
3. Power up the digital control inputs. The relative order of the digital control inputs is not important.
4. Apply an RF input signal to RF1.

The power-down sequence is the reverse of the power-up sequence.

RF INPUT AND OUTPUT

The attenuator in the HMC424ACHIPS is bidirectional. The RF1 and RF2 pins are interchangeable as the RF input and output ports. The attenuator is internally matched to 50 Ω at both the input and the output. Therefore, no external matching components are required.

The RF input and output pins of the HMC424ACHIPS are internally dc biased to 0 V. Therefore, they require external dc blocking capacitors if the RF line potential is not equal to 0 V. Select the value of these dc blocking capacitors based on the minimum operating frequency. Use larger value capacitors to extend the operation to lower frequencies.

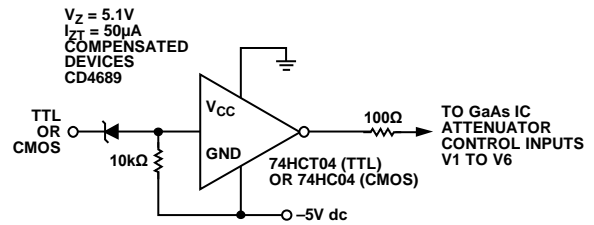

NOTE
CD4689 IS A ZENER DIODE. V_Z IS THE ZENER VOLTAGE, AND I_{ZT} IS THE ZENER TEST CURRENT.

Figure 23. Suggested Driver Circuit

13870-022

Table 5. V1 to V6 Truth Table

Control Voltage Input						Attenuation State, RF1 to RF2
V1 (16 dB)	V2 (8 dB)	V3 (4 dB)	V4 (2 dB)	V5 (1 dB)	V6 (0.5 dB)	
Low	Low	Low	Low	Low	Low	Reference insertion loss
Low	Low	Low	Low	Low	High	0.5 dB
Low	Low	Low	Low	High	Low	1 dB
Low	Low	Low	High	Low	Low	2 dB
Low	Low	High	Low	Low	Low	4 dB
Low	High	Low	Low	Low	Low	8 dB
High	Low	Low	Low	Low	Low	16 dB
High	High	High	High	High	High	31.5 dB

¹ Any combination of the control voltage input states shown in Table 5 provides an attenuation equal to the sum of the bits selected.

APPLICATIONS INFORMATION

MOUNTING AND BONDING TECHNIQUES

The HMC424ACHIPS is back metallized and must be attached directly to the ground plane with gold tin (AuSn) eutectic preforms or with electrically conductive epoxy.

The die thickness is 0.102 mm (4 mil). The 50 Ω microstrip transmission lines on 0.127 mm (5 mil) thick alumina thin film substrates are recommended for bringing RF to and from the HMC424ACHIPS (see Figure 24).

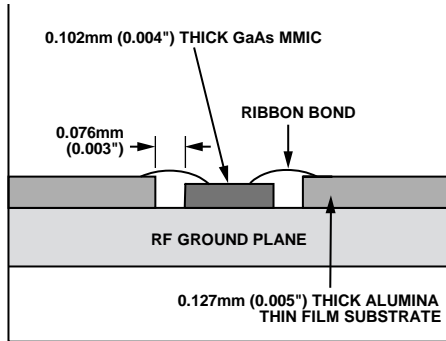

Figure 24. Bonding RF Pads to 5 mil Substrate

When using 0.254 mm (10 mil) thick alumina thin film substrates, the HMC424ACHIPS must be raised 0.150 mm (6 mil) so that the surface of the HMC424ACHIPS is coplanar with the surface of the substrate. One way to accomplish this is by attaching the 0.102 mm

(4 mil) thick die to a 0.150 mm (6 mil) thick molybdenum heat spreader (moly tab), which is then attached to the ground plane (see Figure 25).

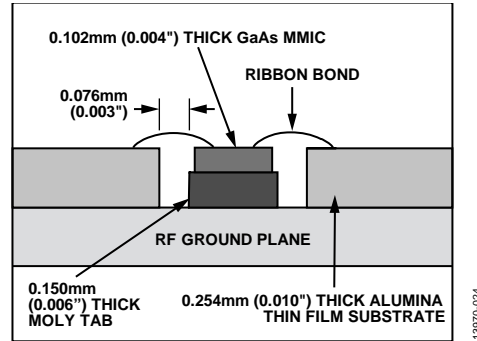

Figure 25. Bonding RF Pads to 10 mil Substrate

Microstrip substrates are placed as close to the HMC424ACHIPS as possible to minimize bond length. Typical die to substrate spacing is 0.076 mm (3 mil).

RF bonds made with 3 mil × 5 mil ribbon are recommended. DC bonds made with 1 mil diameter wire are recommended. All bonds must be as short as possible.

ASSEMBLY DIAGRAM

An assembly diagram of the HMC424ACHIPS is shown in Figure 26.

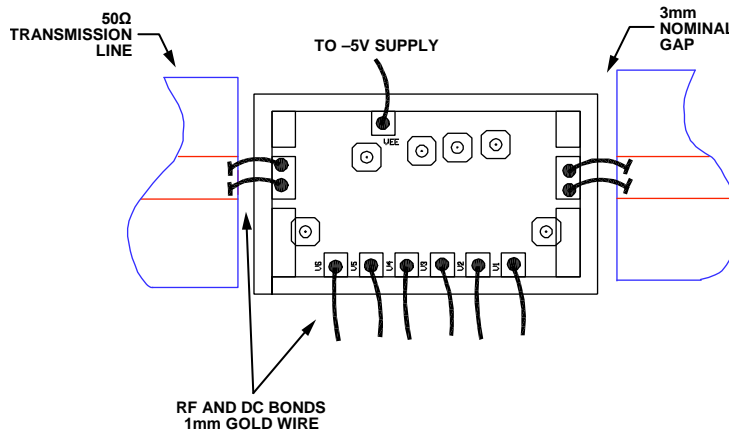

Figure 26. Assembly Diagram

OUTLINE DIMENSIONS

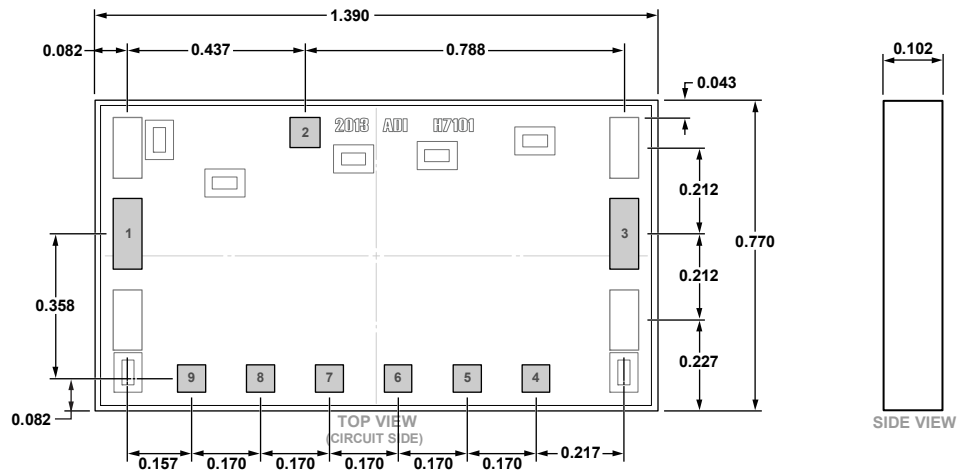

Figure 27. 9-Pad Bare Die [CHIP]
(C-9-2)
Dimensions shown in millimeters

07-19-2019-A

ORDERING GUIDE

Model ¹	Temperature Range	Package Description	Package Option	Marking Code ²
HMC424A	-40°C to +85°C	9-Pad Bare Die [CHIP]	C-9-2	H424A XXXX
HMC424A-SX	-40°C to +85°C	9-Pad Bare Die [CHIP]	C-9-2	H424A XXXX

¹ All models are RoHS compliant.
² XXXX is the 4-digit lot number.

Looking for pricing, stock, or lifecycle information?

Click below to explore more details on WIN SOURCE:

 [View HMC424A-SX on WIN SOURCE](#)

 [Analog Devices Inc. Information](#)

Optimize Your Supply Chain with WIN SOURCE Solutions

-  Global Sourcing Solution
-  Obsolete Management
-  Cost Control Management
-  Shortage Management
-  Alternative Solution
-  Excess Inventory Management