



**THE DATASHEET OF  
EXB-V4V333JV**



DIGI-KEY CORPORATION

Issue No. : 151EXB008056

Date of Issue : November 26.2008

Classification :  New  Changed

## PRODUCT SPECIFICATION FOR APPROVAL

Product Description : Chip Resistor Array (RoHS Compliance)

Product Part Number : EXBV4V \* \* \* □ V

Country of Origin : JAPAN, CHINA, MALAYSIA

Applications : Standard electronic equipment

\*If you approve this specification, please fill in and sign the below and return 1 copy to us.

Approval No	:	
Approval Date	:	
Executed by	:	
		_____
		(signature)
Title	:	
Dept.	:	

Circuit Components Business Unit  
Panasonic Electronic Devices Co., Ltd.

401 Sadamasa-cho,  
Fukui City 910-8502 Japan

Phone : +81-776-56-8034

Fax : +81-776-56-3114

Prepared by : Engineering Section

Contact Person :

Signature

*H. Yabukoshi*

Name(Print)

H.Yabukoshi

Title :

Authorized by :

Signature

*T. Watanabe*

Name(Print)

T.Watanabe

Title :

Manager of Engineering

**Panasonic**

Subject Chip Resistor Array PRODUCT SPECIFICATION FOR INFORMATION	Spec. No. 151-EXB-V4V01LE
Part No. <b>EXBV4V</b>	9-1

### 1. Dimension

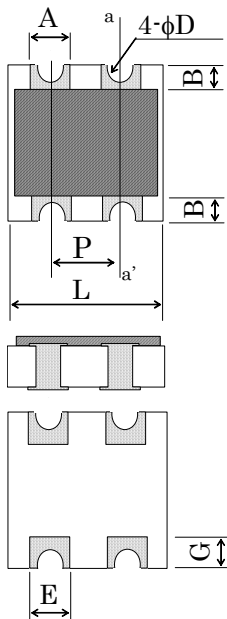

(1)Substrate	(2)Protective coating	(3)Resistive element
Alumina	Resin	Ruthenium oxide
(4)Termination (Inner)	(5)Termination (Between)	(6) Termination (Outer)
Ag or Ag/Pd	Ni Plating	Sn Plating

a-a' sectional plan

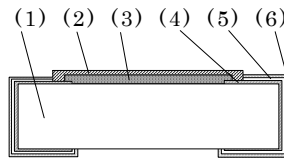

	L	W	T	A	B
Dimension(mm)	1.60 $\begin{smallmatrix} +0.20 \\ -0.10 \end{smallmatrix}$	1.60 $\begin{smallmatrix} +0.20 \\ -0.10 \end{smallmatrix}$	0.60±0.10	0.60±0.10	0.30±0.15

	D	P	E	G
Dimension(mm)	(0.30)	(0.80)	0.45±0.10	0.45±0.15

( ):Reference

### 2. Power derating curve

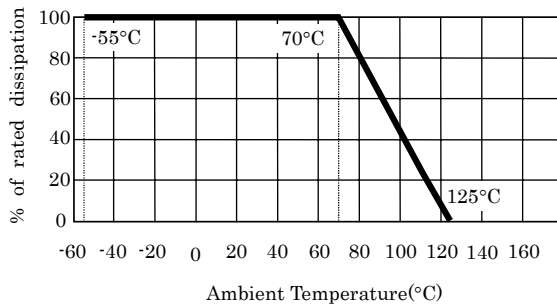

Category temperature range

-55°C~+125°C

Fig. 1

### 3. Ratings

Item	Rated Value	Explanation
Rated Dissipation	0.063 W / element	When used at ambient temperature over 70 °C, the rated dissipation should be reduced as shown in Fig.1
	Chip jumper : Rated current 1 A (Resistance is less than 50 mΩ)	
Rated voltage & Rated Continuous Working Voltage (RCWV)	The rated voltage of each resistor should be calculated from the equation below, and when the rated voltage exceeds the limiting element voltage, the limiting element voltage should be the maximum working voltage. $E = \sqrt{P \times R}$ Limiting element voltage : 50 V E: Rated voltage(V), P: Rated dissipation(W), R: Rated resistance(Ω)	

Subject Chip Resistor Array PRODUCT SPECIFICATION FOR INFORMATION	Spec. No. 151-EXB-V4V01LE
Part No. <b>EXBV4V</b>	9-2

Item	Rated Value	Explanation	
Maximum overload voltage	Voltage should be $2.5 \times E$ . When the voltage exceeds the maximum overload voltage, the value shown below should be the maximum overload voltage. Maximum overload voltage: 100V Chip jumper: Max. overload current 2A		
Resistance tolerance	sign	Tolerance for resistance	
	J	$\pm 5\%$	
	0	Chip Jumper	
Range of rated resistance for manufacture	Tolerance	Resistance range	Series
	J	1.0 $\Omega$ to 1.0 M $\Omega$	E-24
	0	Less than 50 m $\Omega$	-

#### 4. Explanation of part number

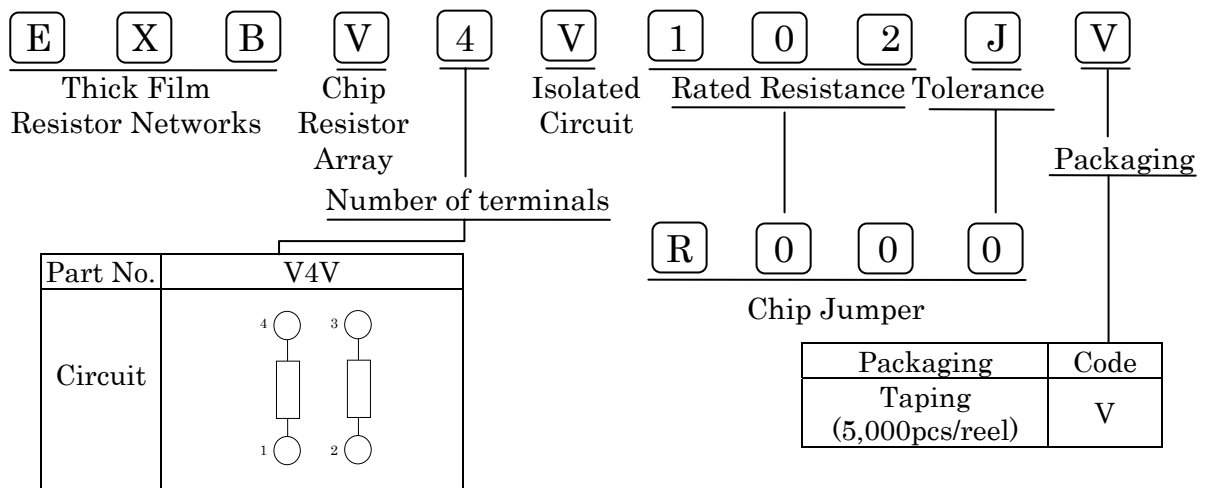

#### 5. Appearance & Construction

Item	Specifications	Explanation
Appearance & Construction	<ol style="list-style-type: none"> <li>The resistive element should be covered with protective coating that do not fade easily. The surface of coating should avoid unevenness, flaw, pinhole and discoloration.</li> <li>The electrode should be printed uniformly, as shown in the dimensions. The plating should not fade easily, and should avoid unevenness, flaw, pinhole, projection and discoloration.</li> <li>The electrode should be connected electrically, mechanically to resistive element.</li> <li>Substrate should not have chipping, flaw, flash and crack. Details of appearance criteria shall be as described in attached sheet</li> </ol>	

Subject	Chip Resistor Array PRODUCT SPECIFICATION FOR INFORMATION	Spec. No.	151-EXB-V4V01LE
Part No.	<b>EXBV4V</b>		9-3

As far as there shall be not designation especially, the following test and measurement shall be operated under normal temperature(5 °C to 35 °C), normal humidity(45 %RH to 85 %RH), normal atmospheric pressure(86 kPa to 106 kPa).

### 6. Performance Specification

Item	Specification		Test methods						
	Resistor	Jumper							
DC resistance	DC resistance value shall be within the specified tolerance	Less than 50 mΩ	Measuring voltage: refer to JIS-C5201-1 At 20 °C, 65 %RH						
Temperature coefficient	<table border="1" style="width: 100%;"> <tr> <th>Resistance</th> <th>TCR</th> </tr> <tr> <td>&lt;10Ω</td> <td><math>\begin{matrix} +600 \\ -100 \end{matrix} \times 10^{-6} / ^\circ\text{C}</math></td> </tr> <tr> <td>10Ω to 1MΩ</td> <td><math>\pm 200 \times 10^{-6} / ^\circ\text{C}</math></td> </tr> </table> <p>Chip jumper : Less than 50 mΩ</p>	Resistance	TCR	<10Ω	$\begin{matrix} +600 \\ -100 \end{matrix} \times 10^{-6} / ^\circ\text{C}$	10Ω to 1MΩ	$\pm 200 \times 10^{-6} / ^\circ\text{C}$		Natural resistance change per temperature degree centigrade. $\text{TCR} = \frac{R_2 - R_1}{R_1 \times (t_2 - t_1)}$ R <sub>1</sub> : Resistance value at reference temperature(t <sub>1</sub> ) R <sub>2</sub> : Resistance value at test temperature(t <sub>2</sub> ) t <sub>2</sub> - t <sub>1</sub> = 100 °C, t <sub>1</sub> = 25 °C
Resistance	TCR								
<10Ω	$\begin{matrix} +600 \\ -100 \end{matrix} \times 10^{-6} / ^\circ\text{C}$								
10Ω to 1MΩ	$\pm 200 \times 10^{-6} / ^\circ\text{C}$								
Overload	±(2 %+0.1 Ω)	Less than 50 mΩ	Resistors shall be applied 2.5 times the rated voltage for 5 seconds. Maximum over load voltage shall be 100 V.						
Intermittent Overload	±(5 %+0.1 Ω)	Less than 50 mΩ	Resistors shall be subjected to 10000 cycles of 2.5 times the rated voltage applied for 1 second with pause of 25 seconds between tests. Maximum over load voltage shall be 100 V						
Dielectric Withstanding	No evidence of flashover, mechanical damage, arcing or insulation breakdown.		AC 100V between substrate and termination for 1 minute.						
Insulation Resistance	Min. 1,000 MΩ		Insulation resistance between substrate and termination shall be measured at DC 100V.						

### 7. Mechanical characteristic

Item	Specification		Test methods
	Resistor	Jumper	
Bend strength of the face plating	No mechanical damage		Substrate: Glass epoxy(t = 1.6 mm) Span: 90 mm Bending distance: 3 mm (10 seconds)
	±(1 %+0.05 Ω)	Less than 50 mΩ	
Solderability	Termination should be covered uniformly with solder. (min. 95 % coverage)		Resistors shall be dipped in the melted solder bath at 230 °C ± 5 °C for 3 s ± 0.5 s. Flux shall be removed from the surface of termination with clean organic solvent.

Subject Chip Resistor Array PRODUCT SPECIFICATION FOR INFORMATION	Spec. No. 151-EXB-V4V01LE
Part No. <b>EXBV4V</b>	9-4

Item	Specification		Test methods
	Resistor	Jumper	
Resistance to soldering heat	$\pm(1\%+0.05\ \Omega)$	Less than 50 m $\Omega$	Resistors shall be dipped in the melted solder bath at 270 °C $\pm$ 5 °C for 10s $\pm$ 1s.
Vibration	$\pm(1\%+0.05\ \Omega)$	Less than 50 m $\Omega$	Resistors shall be subjected to a single vibration having as double amplitude of 1.5 mm for 2 hours in each three mutually perpendicular directions for total 6 hours. The vibration frequency shall be varied uniformly 10 Hz to 55 Hz and return to 10 Hz traversing for 1 minute.
Solvent resistance	Without distinct deformation in appearance		Solvent solution: Isopropyl alcohol (1) Dipping 10 hours $\pm$ 1 hour, dry in room condition for 30 min $\pm$ 10 min. (2) Ultrasonic wave washing: 5 min $\pm$ 1 min (0.3 W/cm <sup>2</sup> , 28 kHz) Dry in room condition for 30 min $\pm$ 10 min.
	$\pm(0.5\%+0.05\ \Omega)$	Less than 50 m $\Omega$	

## 8. Environmental Test

Item	Specification		Test methods
	Resistor	Jumper	
Low temperature exposure	$\pm(1\%+0.05\ \Omega)$	Less than 50 m $\Omega$	Resistors shall be exposed at -55 °C $\pm$ 3 °C for 1000 hours $\begin{smallmatrix} +48 \\ 0 \end{smallmatrix}$ hours
Endurance at upper category temperature	$\pm(1\%+0.05\ \Omega)$	Less than 50 m $\Omega$	Resistors shall be exposed at +125 °C $\pm$ 3 °C for 1000 hours $\begin{smallmatrix} +48 \\ 0 \end{smallmatrix}$ hours.
Temperature cycling	$\pm(1\%+0.05\ \Omega)$	Less than 50 m $\Omega$	-55 °C $\pm$ 3 °C, 30 minutes $\uparrow\downarrow$ Nominal temp., 30minutes 25cycles $\uparrow\downarrow$ +125 °C $\pm$ 3 °C, 30minutes
Humidity (Steady state)	$\pm(1\%+0.05\ \Omega)$	Less than 50 m $\Omega$	Resistors shall be exposed at 60 °C $\pm$ 2 °C and 90 % to 95 % relative humidity in a humidity test chamber for 1000 hours $\begin{smallmatrix} +48 \\ 0 \end{smallmatrix}$ hours.
Endurance at 70 °C	$\pm(3\%+0.1\ \Omega)$	Less than 50 m $\Omega$	Resistors shall be exposed at 70 °C $\pm$ 2 °C for 1000 hours $\begin{smallmatrix} +48 \\ 0 \end{smallmatrix}$ hours. During this time, the rated voltage shall be applied intermittently for 1.5 hours ON, 0.5 hour OFF.
Load life in Humidity	$\pm(3\%+0.1\ \Omega)$	Less than 50 m $\Omega$	Resistor shall be exposed at 60 °C $\pm$ 2 °C and 90 % to 95 % relative humidity for 1000 hours $\begin{smallmatrix} +48 \\ 0 \end{smallmatrix}$ hours. During this time, the rated voltage shall be applied intermittently for 1.5 hours ON, 0.5 hour OFF.

Subject	Chip Resistor Array PRODUCT SPECIFICATION FOR INFORMATION	Spec. No.	151-EXB-V4V01LE
Part No.	<b>EXBV4V</b>		9-5

## 9. Resistance value marking

Express resistance value on resin side with three digits.

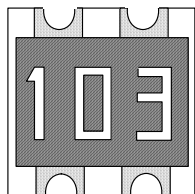

(Example)

103 → 10 kΩ The first two digits should be significant figures of resistance for E-24 series and the third one denotes number of zeros in ohms.

000 → Chip jumper

Subject	Spec. No.
Chip Resistor Array PRODUCT SPECIFICATION FOR INFORMATION	151-EXB-V4V01LE
Part No.	
<b>EXBV4V</b>	<b>9-6</b>

## 10. Notice for use

### Notice for use

- (1) This specification shows the quality and performance of the product in a unit component. Before adoption, be sure to evaluate and verify the product mounting it in your product.
- (2) We take no responsibility for troubles caused by the product usage that is not specified in this specification.
- (3) In traffic transportation equipment (trains, cars, traffic signal equipment, etc.), medical equipment, aerospace equipment, electric heating appliances, combustion and gas equipment, rotating equipment, disaster and crime preventive equipment, etc. in cases where it is forecast that the failure of this product gives serious damage to human life and others, use fail-safe design and ensure safety by studying the following items to
  - ◆ Ensure safety as the system by setting protective circuits and protective equipment.
  - ◆ Ensure safety as the system by setting such redundant circuits as do not cause danger by a single failure.
- (4) When a dogma shall be occurred about safety for this product, be sure to inform us rapidly, operate your technical examination.
- (5) The product is designed to use in general standard applications of general electric equipment (AV products, household electric appliances, office equipment, information and communication equipment, etc.); hence, it do not take the use under the following special environments into consideration.  
Accordingly, the use in the following special environments, and such environmental conditions may affect the performance of the product; prior to use, verify the performance, reliability, etc. thoroughly.
  - 1) Use in liquids such as water, oil, chemical, and organic solvent.
  - 2) Where the product is close to a heating component, or where an inflammable such as a polyvinyl chloride wire is arranged close to the product.
  - 3) Where the product is sealed or coated with resin, etc.
  - 4) Where water or a water-soluble detergent is used in cleaning free soldering (Pay particular attention to soluble flux.)
  - 5) Use in such a place where the product is wetted due to dew condensation.
  - 6) Use in places full of corrosive gases such as sea breeze, Cl<sub>2</sub>, H<sub>2</sub>S, NH<sub>3</sub>, SO<sub>2</sub>, and NO<sub>x</sub>.
  - 7) Use under direct sunlight, in outdoor or in dusty atmospheres.
  - 8) Use in environment with large static electricity or strong electromagnetic waves.
- (6) If transient load (heavy load in a short time) like pulse is expected to be applied, carry out evaluation and confirmation test with resistors actually mounted on your own board. When the load of more than rated power is applied under the load condition at steady state, it may impair performance and/or reliability of resistor. Never exceed the rated power.  
When the product shall be used under special condition, be sure to ask us in advance.
- (7) Halogen type (chlorine type, bromine type, etc.) or other high-activity flux is not recommended as the residue may affect performance or reliability of resistors.
- (8) When soldering with soldering iron, never touch the body of the chip resistor with a tip of the soldering iron. When using a soldering iron with a tip at high temperature, solder for a time as short as possible. (Three seconds or less up to 350 °C)
- (9) Avoid physical shock to the resistor and nipping of the resistor with hard tool (a pair of pliers or tweezers) as it may damage protective film or the body of resistor and may affect resistor's performance.
- (10) Reflow soldering method shall apply to this product in principle.

Subject	Spec. No.
Chip Resistor Array PRODUCT SPECIFICATION FOR INFORMATION	151-EXB-V4V01LE
Part No.	
<b>EXBV4V</b>	9-7

### 11. Storage method

If the product is stored in the following environments and conditions, the performance and solderability may be badly affected. Avoid the storage in the following environments.

- (1) Storage in places full of corrosive gases such as sea breeze, Cl<sub>2</sub>, H<sub>2</sub>S, NH<sub>3</sub>, SO<sub>2</sub>, and NO<sub>x</sub>.
- (2) Storage in places exposed to direct sunlight.
- (3) Storage in places outside the temperature range of 5 °C to 35 °C and humidity range of 45 %RH to 85 %RH.
- (4) Storage over a year after our delivery (This item also applies to the case where the storage method specified in item (1) to (3) has been followed.).

### 12. Laws and Regulations

- (1) No ODCs or other ozone-depleting substances that are subject to regulation under the Montreal Protocol are used in our manufacturing processes, including in the manufacture of this product.
- (2) This product complies with the RoHS Directive (Restriction of the use of certain Hazardous Substances in electrical and electronic equipment (DIRECTIVE 2002/95/EC)).
- (3) All materials used in this product are existing chemical substances recognized under "laws on examination of chemical substances and regulations of manufacturing and others."
- (4) None of the materials used in this product contain the designated incombustible bromic substances, PBBOs and PBBs.
- (5) Please contact us to obtain a notice as to whether this product has passed inspection under review criteria primarily based on Foreign Exchange and Foreign Trade Control Laws, and appended table in the Export Control Laws.

### 13. Production Place

Production Country : Japan

Production Plant : Panasonic Electronic Devices Japan Co., Ltd.

Production Country : China

Production Plant : Panasonic Electronic Devices (Tianjin) Co., Ltd. (PEDTJ)

Production Country : Malaysia

Production Plant : Panasonic Electronic Devices Malaysia Sdn. Bhd. (PEDMA)

Subject	Chip Resistor Array PRODUCT SPECIFICATION FOR INFORMATION	Spec. No.	151-EXB-V4V01LE
Part No.	<b>EXBV4V</b>		9-8

## 14. Tape and Reel Package

### 14-1. Physical Dimensions

Structure and reel dimensions shall be as shown in the figure below.

In accordance with EIAJ ET-7200.

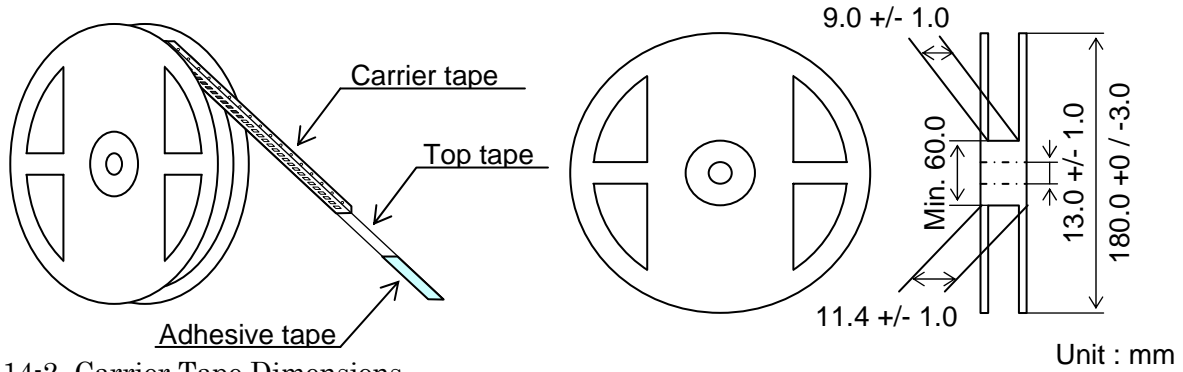

### 14-2. Carrier Tape Dimensions

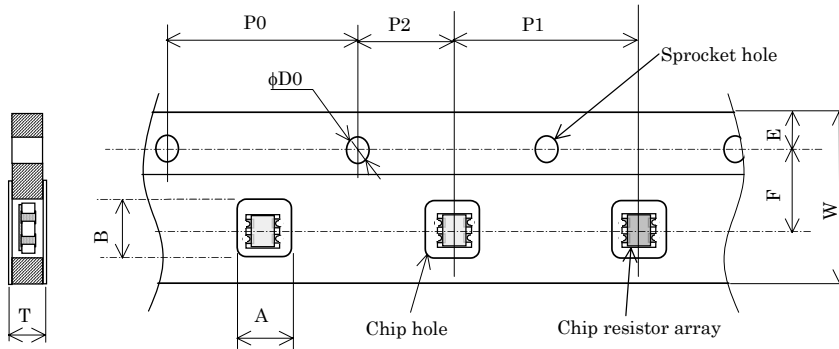

	A	B	W	F	E
(mm)	1.95±0.15	1.95±0.20	8.00±0.20	3.50±0.05	1.75±0.10

	P1	P2	P0	T	φD0
(mm)	4.00±0.10	2.00±0.05	4.00±0.10	0.84±0.05	1.50 <sup>+0.10</sup> <sub>0</sub>

### 14-3. Specification

#### 14-3-1. Taping

(1) When the test shall be operated with the below conditions, peel strength should be 0.049N

to 0.49N, should not have flash and tear after peeling.

<Test Method>

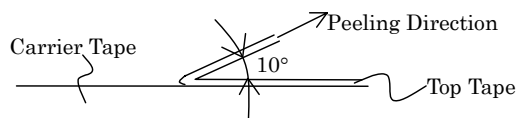

#### (2) Minimum Bending Radius

When carrier tape shall be bent by minimum bending radius (15 mm), no deflection of chip and no break of carrier tape. However minimum bending radius shall be tested for 1 times.

Subject	Spec. No.
Chip Resistor Array PRODUCT SPECIFICATION FOR INFORMATION	151-EXB-V4V01LE
Part No.	
<b>EXBV4V</b>	9-9

(3) Resistance to climate

When resistors shall be exposed at  $60\text{ }^{\circ}\text{C} \pm 2\text{ }^{\circ}\text{C}$ , 90 %RH to 95 %RH for 120 hours, no deflection of chip and no break off carrier tape.

When the top tape shall be peeled, tape should not have flash and tear.

14-3-2. Quantity in Taping: 5,000 pcs. / reel

14-3-3. Tape packaging

(1) Resistor side shall be facing upward.

(2) Chip resistor shall not be sticking to top tape and bottom tape.

(3) Chip resistors shall be easy to take out from carrier tape and chip hole or sprocket hole shall not have flash and break.

14-4. Outer Packaging

Quantity: 20 reels(Max.100,000 pcs.)

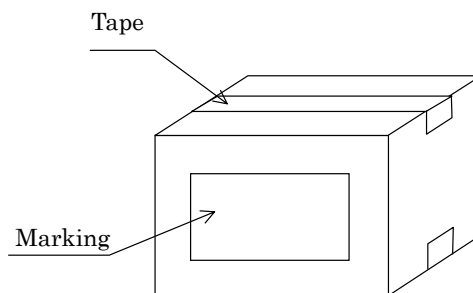

(1) When packaging quantity does not reach max quantity, the remaining empty space shall be buried with buffer material.

(2) When quantity shall be few, alternative packaging methods may used. No problem must occur during the exportation of the product..

14-5. Marking

At last, production country is displayed in English.

- Side of reel (Marking shall be on one side.)

(1)Part name (2)Part number (3)Quantity (4)Lot number (5)Maker name  
(6)Production country

- Packaging box

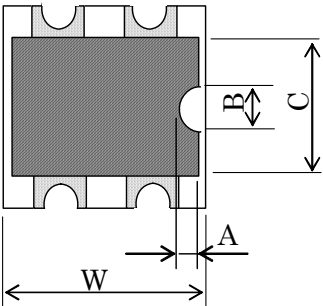
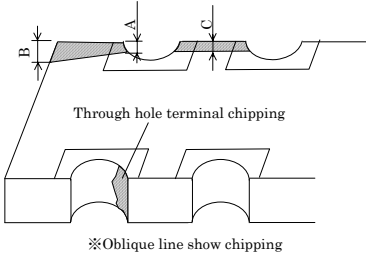
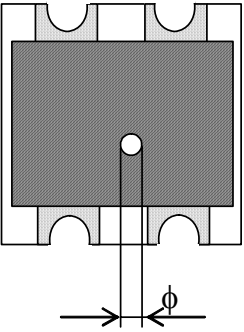
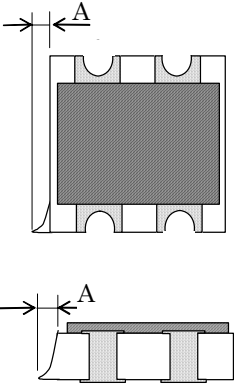

(1)Customer name (2)Part name (3)Part number (4)Customer part number  
(5)Quantity (6)Maker name (7) Production country

<b>APPEARANCE QUALITY CRITERIA</b>	1-1
------------------------------------	-----

Item	Defect Criteria	Appearance Criteria	Remark
Resin Chipping		$A \leq W/8$ $B \leq C/2$	Both side chipping shall be judged defect
Terminal Chipping	 <p style="font-size: small;">※Oblique line show chipping</p>	$A \leq 1/2$ of radius $B \leq$ Top terminal width $D \geq 1/2$ of radius  Through hole's chipping area is within 1/4 of through hole's area.	
Pin Hole		One pin hole / chip resistor $\phi \leq 0.2$ mm	This item is applied to pin holes which reach to the resistive materials
Flash		$A \leq 100$ $\mu$ m	

## Looking for pricing, stock, or lifecycle information?

Click below to explore more details on WIN SOURCE:

-  [View EXB-V4V333JV](#) on WIN SOURCE
-  [Panasonic](#) Information

## Optimize Your Supply Chain with WIN SOURCE Solutions

-  Global Sourcing Solution
-  Obsolete Management
-  Cost Control Management
-  Shortage Management
-  Alternative Solution
-  Excess Inventory Management