



**THE DATASHEET OF
LTC3896IFE**



Bipolar, Bidirectional DC-to-DC Supply Sources and Sinks Current from 5 V to 24 V Input

Victor Khasiev, Senior Applications Engineer

Introduction

Most electronic systems depend on power voltage rails that are either positive or negative, but a few applications require individual rails that can be both. In these situations, positive or negative power is supplied by the same terminal—that is, the output voltage of the supply can be adjusted through its entire voltage range, smoothly transitioning across polarity. For instance, some automotive and audio applications require, in addition to traditional voltage sources, power supplies that can function as a load and sinking current from the output terminals. Regenerative braking in automotive systems is one example. Single terminal, bipolar power supplies are documented, but solutions that can operate during input voltage drops, such as cold crank conditions, while continuing to provide bidirectional functionality are not. This article presents a solution immune to input voltage changes while generating power and enabling reverse current flow, that is, from output to input.

The low-pass filter C_F , R_F alleviates sharp changes in control voltage. The power train includes two MOSFETs, N-channel QN1, and P-channel QP1; two discrete inductors, L1 and L2; and an output filter. The choice of two discrete inductors instead of a single coupled inductor extends the range of suitable magnetics and allows the use of previously approved and tested chokes. The output filter is composed exclusively of ceramic capacitors because of the dual polarity nature of the output.

The input voltage range of the full 2-stage converter is 5 V to 24 V, to cover cold cranking voltage drops in automotive electronics and brownouts in industrial applications. The boost converter (stage 1), based on controller U2, maintains the voltage of the intermediate bus at or above 12 V whenever the converter is enabled. The power train of the boost converter includes inductor L3 and MOSFETs Q1 and Q2. The 2-stage arrangement allows normal operation of the downstream 4-quadrant converter to deliver ± 10 V to the load at all operational conditions.

Bipolar, Bidirectional Power Supply Circuit

Figure 1 shows a 2-stage power supply, which centers around a 4-quadrant controller (stage 2), U1. This 4-quadrant converter is fed by an intermediate bus converter, V_{INTER} (stage 1), supplying an output voltage in a min-max range of 12 V to 24 V, nominally 12 V to 16 V, matching the nominal voltage range of the standard automotive battery rail. The output of the complete 2-stage converter is ± 10 V delivering a 3 A current to the load. The output voltage is controlled by the voltage source CONTROL signal at the CTRL pin of controller U1.

How It Works when the Bipolar Supply Sources Current

The oscillogram in Figure 2 shows the circuit of Figure 1 in action. When an input voltage is applied at V_{IN} , the boost converter regulates its output, V_{INTER} , to 12 V if the input falls below this level. If V_{IN} exceeds the 12 V typical for a nominal 12 V automotive rail, then the boost converter enters Pass-Thru™ mode or wire mode. In this mode, the top MOSFET Q1 is enhanced at 100% duty cycle, always on operation, so no switching occurs—the voltage, V_{INTER} , applied to a 4-quadrant converter remains relatively stable at a level equal to V_{IN} .

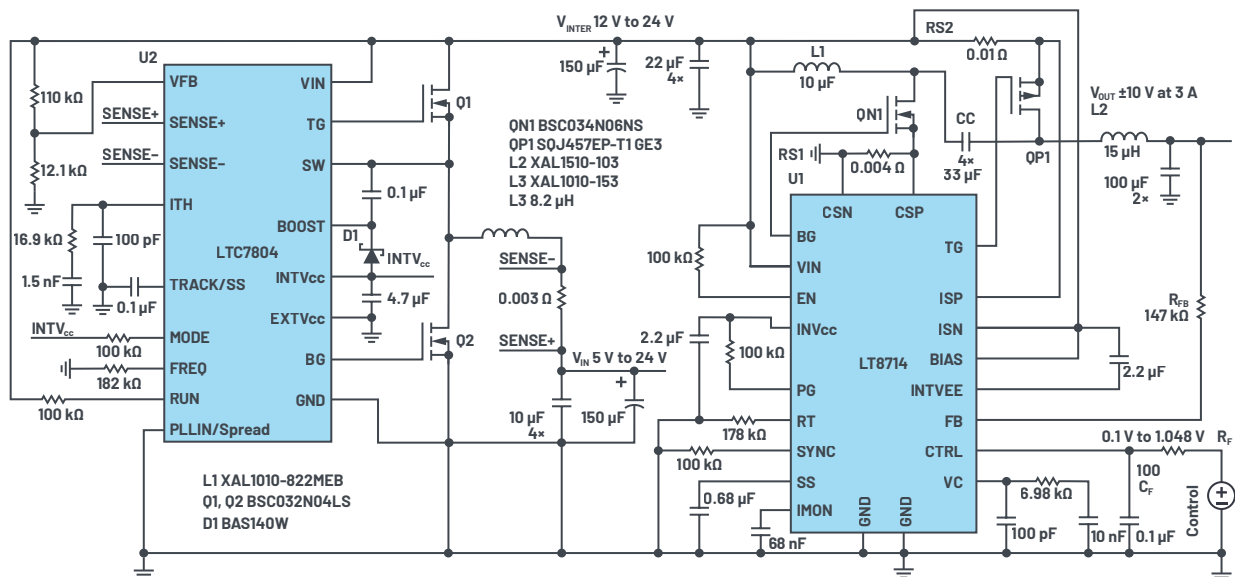

Figure 1. Electrical schematic of bipolar, bidirectional, 2-terminal power supply: $V_{IN} = 5$ V to 24 V, $V_{OUT} = \pm 10$ V at 3 A.

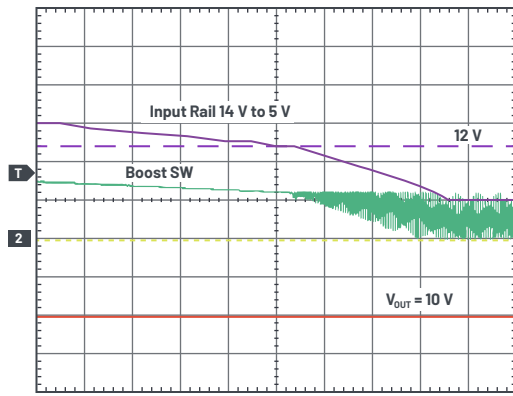

Figure 2. Waveforms showing V_{IN} dropping from 14 V to 5 V. $V_{IN} = 5$ V/div, $V_{OUT} = 5$ V/div, boost SW = 10 V/div, and the time scale is 200 μ s/div.

This approach greatly increases system efficiency over a typical 2-stage device (namely, a boost converter followed by buck/inverting). This is because efficiency in Pass-Thru mode, where the system will spend most of its time, can be near 100%, essentially turning the power system into a single-stage converter. If the input voltage drops below the 12 V level—for example, during a cold cranking event—then the boost converter resumes switching to regulate V_{INTER} to 12 V. This approach allows the 4-quadrant converter to deliver ± 10 V, even when facing sharp drops of the input voltage.

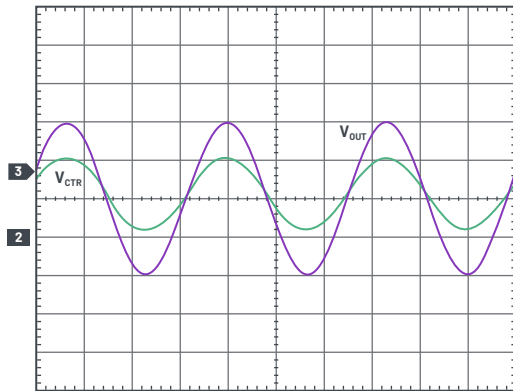

Figure 3. Waveforms of sine wave output as function of the sine control signal. $V_{CTRL} = 0.5$ V/div, $V_{OUT} = 5$ V/div, and the time scale is 5 ms/div.

When the control voltage is at its maximum—in this case, 1.048 V—the converter output is +10 V. If the control voltage is at its minimum (100 mV), the converter output is -10 V. Control voltage vs. output voltage is shown in Figure 3, where the control voltage is a 60 Hz sinusoidal signal frequency with a peak-to-peak amplitude of 0.9048 V. The resulting converter output is a correspondingly 60 Hz sine wave with a peak-to-peak amplitude of 20 V. The output smoothly changes from -10 V to +10 V.

In this mode of operation, the 4-quadrant converter regulates the output voltage. The output voltage is sensed by U1 through the resistor R_{FB} at its FB pin. The voltage at that pin is compared to the control voltage, and from that comparison, the converter's duty cycle—that is, the gate signal on QN1—is adjusted to keep the output voltage in regulation. If V_{INTER} , CONTROL, or V_{OUT} changes, the duty cycle is modulated to regulate the output accordingly. MOSFET QP1 switches in sync with QN1 for synchronous rectification to further maximize efficiency, as shown in Figure 4.

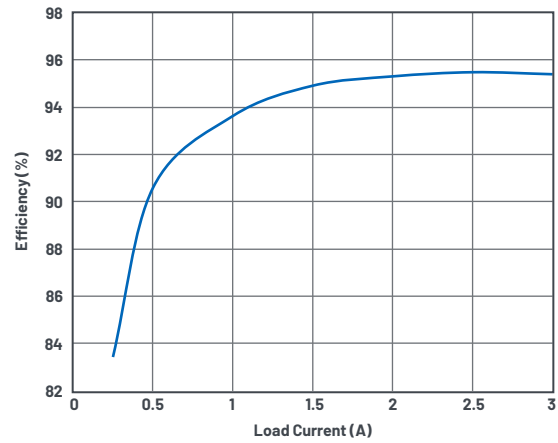

Figure 4. Efficiency vs. load current.

How It Works when the Bipolar Supply Becomes the Load: It Sinks Current

This 2-stage regulator can operate as a current source or a current sink. In current sink mode, current and power flow in reverse from the output, V_{OUT} , to the input, V_{IN} . This is important for automotive electronics and some audio systems. For the purposes of settling on verbiage when describing this mode, V_{OUT} will now be referred to as the input and V_{IN} will now be referred to as the output. Furthermore, this article only considers applications where V_{INTER} bus voltage is equal to or greater than the minimum 12 V.

During reverse current flow, the 4-quadrant converter regulates output current that passes from V_{OUT} to V_{IN} ; the converter does not regulate voltage in this mode. The 4-quadrant controller senses output current as the voltage drop across the sense resistor, RS2 in Figure 1, and regulates its duty cycle to keep this voltage drop at a set value, 50 mV, for this solution.

As a 4-quadrant converter generates voltage on the V_{INTER} bus that exceeds the specified minimum, the boost converter enters Pass-Thru mode with top MOSFET Q1 always on and delivers the preset value of the output current to V_{IN} (load) terminals with the smallest losses possible.

This mode of operation was benchtop verified and tested. To do so, the V_{OUT} of the circuit in Figure 1 was connected to a lab power supply set to 12.5 V and the V_{IN} to an electronic load, with the current through the converter set to 4.5 A. The thermal image of the 4-quadrant converter is shown in Figure 5.



Figure 5. Thermal image of the 4-quadrant converter power train in load (reverse current) mode. A 4.5 A current flows from V_{OUT} terminals to V_{IN} from a 12.5 V source at V_{OUT} .

Figure 6 shows a photo of the converter itself, composed of two demo circuits from ADI soldered together: namely an off-the-shelf DC2846A boost converter demonstration circuit and the DC2240A 4-quadrant converter demo circuit.

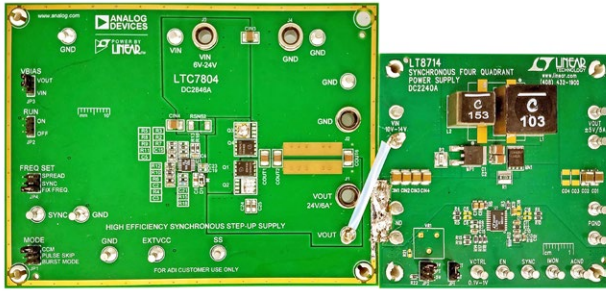

Figure 6. Photo of the test fixture produced by soldering together two off-the-shelf demo boards from ADI. On the left, LTC7804 (DC2846A). On the right, LT8714 (DC2240A).

Component Selection and Power Train Calculations

The two controllers selected for this application were chosen for high performance, efficiency, and ease of use in their relatively specialized functions. The Power by Linear™ LT8714 is an easy to use 4-quadrant controller, featuring high efficiency synchronous rectification. The LTC7804 synchronous boost converter includes an internal charge pump, providing an efficient, switching free, Pass-Thru, 100% duty cycle mode of operation.

What follows is a formulaic analysis of stresses on the power train component and preliminary components selection. For deeper understanding and details of functionality, please refer to the LTspice® models for these devices.

Table 1. 4-Quadrant Converter Power Train Calculations

Power Train Calculations	
$V_{INTER} = 1.2 \times V_{OUT} $	Set minimum V_{INTER} value
$D_{4Q} = \frac{V_{INTER} + V_{OUT}}{2 \times V_{INTER} + V_{OUT}}$	4-quadrant duty cycle
$I_{AVG} = I_{OUT} \times \frac{D_{4Q}}{\eta \times (1 - D_{4Q})}$	Average L1 current η = efficiency
$I_{L1} = I_{AVG} + \frac{\Delta I}{2}$	Peak current in L1
$I_{L2} = I_{OUT} + \frac{\Delta I}{2}$	Peak current in L2
$V_Q = 2 \times V_{INTER} + V_{OUT}$	Q1 and QP1 voltage stress

Table 2. 4-Quadrant Converter Control Circuit Calculations

Control Circuit Calculations	
$V_{CTRN} = 0.1 \text{ V}$	Control voltage for minimum negative V_{OUT}
$R_{FB} = \frac{[7.25 \text{ k}\Omega \times (-V_{OUT} - V_{CTRN})]}{(V_{CTRN} - 0.6065 \text{ V})}$	Set feedback resistor R_{FB} ; select nearest standard value of R_{FB}
$V_{CTRP} = \frac{+V_{OUT} + 83.7 \mu\text{A} \times R_{FB}}{1 + \frac{R_{FB}}{7.25 \text{ k}\Omega}}$	Control voltage for maximum positive V_{OUT}

Table 3. Boost Converter Calculations*

$D_{BOOST} = \frac{V_{INTER} - V_{IN}}{V_{INTER}}$	Boost duty cycle, for $V_{IN} < V_{INTER}$
--	--

*Q1, Q2 voltage stress is defined by the maximum value V_{INTER} or V_{IN} .

Numerical Example

Here is a numerical example, using the previous formulas applied to a converter generating $\pm 10 \text{ V}$ at 3 A, 200 kHz switching frequency, and 90% efficiency:

$$V_{INTER} = 12 \text{ V}$$

$$D_{4Q} = 0.647 \text{ V}$$

Based on the max current limit vs. the duty cycle plot in the LT8714 data sheet, $V_{CSP} = 57 \text{ mV}$ for given D_{4Q} .

$$R_{S1} = 0.63 \times V_{CSP} / I_{OUT} \times (1 - D_{4Q}) = 0.004 \Omega$$

$$R_{S2} = (50 \text{ mV} / 1.5) \times I_{OUT} = 0.01 \Omega$$

L1 is selected as 10 μH and L2 as 15 μH

$$I_{L1} = 6.1 \text{ A}; \quad I_{L2} = 4.3 \text{ A}$$

$$V_Q = 58 \text{ V (at maximum } V_{IN} \text{ of } 24 \text{ V)}$$

$$V_{CTRN} = 0.1 \text{ V}$$

$$V_{CTRP} = 1.048 \text{ V}$$

$$R_{FB} = 147 \text{ k}\Omega$$

Q1, Q2 voltage stress is 24 V

Conclusion

The converter presented in this article is a high performance solution for a bipolar, bidirectional power supply. A few specific features contribute to the performance of the overall solution: synchronous rectification yields high efficiency, and the simple, dedicated control scheme makes for an easy interface to any type of host processor and external control circuitry. This particular solution solves the problem of unstable input voltages, including fast transients, and guarantees stable output voltage in all operating conditions. The devices chosen for the solution maximize efficiency and ease of design. The LT8714, for instance, enables easy design of bipolar, bidirectional power supplies. The LTC7804 enables near-100% efficiency operation as an intermediate supply in automotive and industrial environments.

About the Author

Victor Khasiev is a senior applications engineer at ADI with extensive experience in power electronics both in ac-to-dc and dc-to-dc conversion. He holds two patents and has written multiple articles. These articles relate to the use of ADI semiconductors in automotive and industrial applications. They cover step-up, step-down, SEPIC, positive-to-negative, negative-to-negative, flyback, forward converters, and bidirectional backup supplies. His patents include efficient power factor correction solutions and advanced gate drivers. Victor enjoys supporting ADI customers: answering questions about ADI products, design and verification of power supply schematics, layout of the print circuit boards, troubleshooting, and participating in testing final systems. He can be reached at victor.khasiev@analog.com.

Engage with the ADI technology experts in our online support community. Ask your tough design questions, browse FAQs, or join a conversation.



Visit ez.analog.com



AHEAD OF WHAT'S POSSIBLE™

For regional headquarters, sales, and distributors or to contact customer service and technical support, visit analog.com/contact.

Ask our ADI technology experts tough questions, browse FAQs, or join a conversation at the EngineerZone Online Support Community. Visit ez.analog.com.



©2020 Analog Devices, Inc. All rights reserved. Trademarks and registered trademarks are the property of their respective owners.

TA21952-4/20



VISIT ANALOG.COM

Looking for pricing, stock, or lifecycle information?

Click below to explore more details on WIN SOURCE:

-  [View LTC3896IFE on WIN SOURCE](#)
-  [Analog Devices Inc. Information](#)

Optimize Your Supply Chain with WIN SOURCE Solutions

-  Global Sourcing Solution
-  Obsolete Management
-  Cost Control Management
-  Shortage Management
-  Alternative Solution
-  Excess Inventory Management