



**THE DATASHEET OF
FXP70.07.0053A**





TAOGLAS®

Datasheet

Freedom

Part No:
FXP70.07.0053A

Description:

2.4GHz Freedom Flexible PCB Antenna
with 53mm 1.13 Cable and IPEX MHFI (U.FL) Connector

Features:

- Low profile antenna
- High performance magnetic field antenna
- Flexible PCB Antenna with 3M adhesive
- Dimensions: 27*25*0.2mm
- Cable: 53mm 1.13
- Connector: IPEX MHFI (U.FL)
- RoHS & Reach Compliant

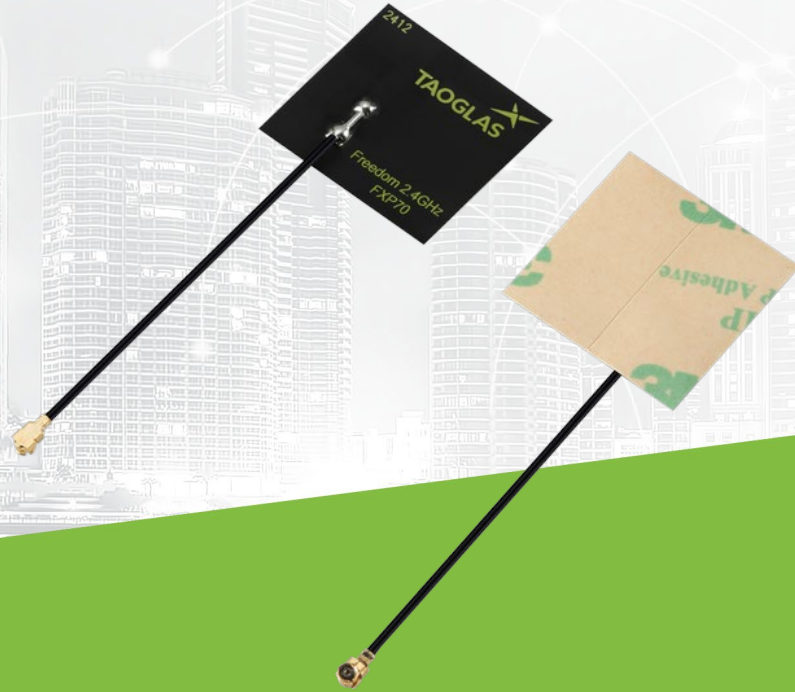

1. Introduction	3
2. Specifications	4
3. Antenna Characteristics	5
4. Radiation Patterns	7
5. Mechanical Drawing	9
6. Packaging	10
<hr/>	
Changelog	11

Taoglas makes no warranties based on the accuracy or completeness of the contents of this document and reserves the right to make changes to specifications and product descriptions at any time without notice. Taoglas reserves all rights to this document and the information contained herein. Reproduction, use or disclosure to third parties without express permission is strictly prohibited.

Ireland & USA
ISO 9001:2015
Certified



Taiwan
ISO 9001:2015
Certified



046



IATF16949



1. Introduction



The FXP70 Freedom 2.4GHz Antenna works on Wi-Fi®, ZigBee®, Bluetooth® and ISM band at 2.4GHz. This antenna has been designed as a general solution to cover the current market applications, with easy installation through a cable connection. The antenna has been designed to work on different plastics material and thickness. We have selected a piece of ABS plastic with 2mm of thickness as a baseline for testing.

Many module manufacturers specify peak gain limits for any antennas that are to be connected to that module. Those peak gain limits are based on free-space conditions. In practice, the peak gain of an antenna tested in free-space can degrade by at least 1 or 2dBi when put inside a device. So ideally you should go for a slightly higher peak gain antenna than mentioned on the module specification to compensate for this effect, giving you better performance.

Upon testing of any of our antennas with your device and a selection of appropriate layout, integration technique, or cable, Taoglas can make sure any of our antennas' peak gain will be below the peak gain limits. Taoglas can then issue a specification and/or report for the selected antenna in your device that will clearly show it complying with the peak gain limits, so you can be assured you are meeting regulatory requirements for that module.

For example, a module manufacturer may state that the antenna must have less than 2dBi peak gain, but you don't need to select an embedded antenna that has a peak gain of less than 2dBi in free-space. This will give you a less optimized solution. It is better to go for a slightly higher free-space peak gain of 3dBi or more if available. Once that antenna gets integrated into your device, performance will degrade below this 2dBi peak gain due to the effects of GND plane, surrounding components, and device housing. If you want to be absolutely sure, contact Taoglas and we will test. Choosing a Taoglas antenna with a higher peak gain than what is specified by the module manufacturer and enlisting our help will ensure you are getting the best performance possible without exceeding the peak gain limits.

The cable and connector are fully customizable, for more information please contact your regional Taoglas customer support team.

2. Specifications

Wi-Fi MIMO	
Frequency (MHz)	2400~2500
Efficiency (%)	
2mm ABS	63.7
Free Space	30.5
Average Gain (dB)	
2mm ABS	-2
Free Space	-5.2
Peak Gain (dBi)	
2mm ABS	1.1
Free Space	-1.9
Impedance	50 Ω
Polarization	Linear
Radiation Pattern	Omni
VSWR	$\leq 1.5:1$
Max. input power	5W

Mechanical	
Dimensions	27 X 25 X 0.08 mm
Weight	1.2 g
Connector	MHFI (U.FL Compatible)
Cable	53mm of Mini-Coax 1.13 mm
Adhesive	3M 467
Environmental	
Temperature Range	-40°C to 85°C
Humidity	Non-condensing 65°C 95% RH

3. Antenna Characteristics

3.1 Return Loss

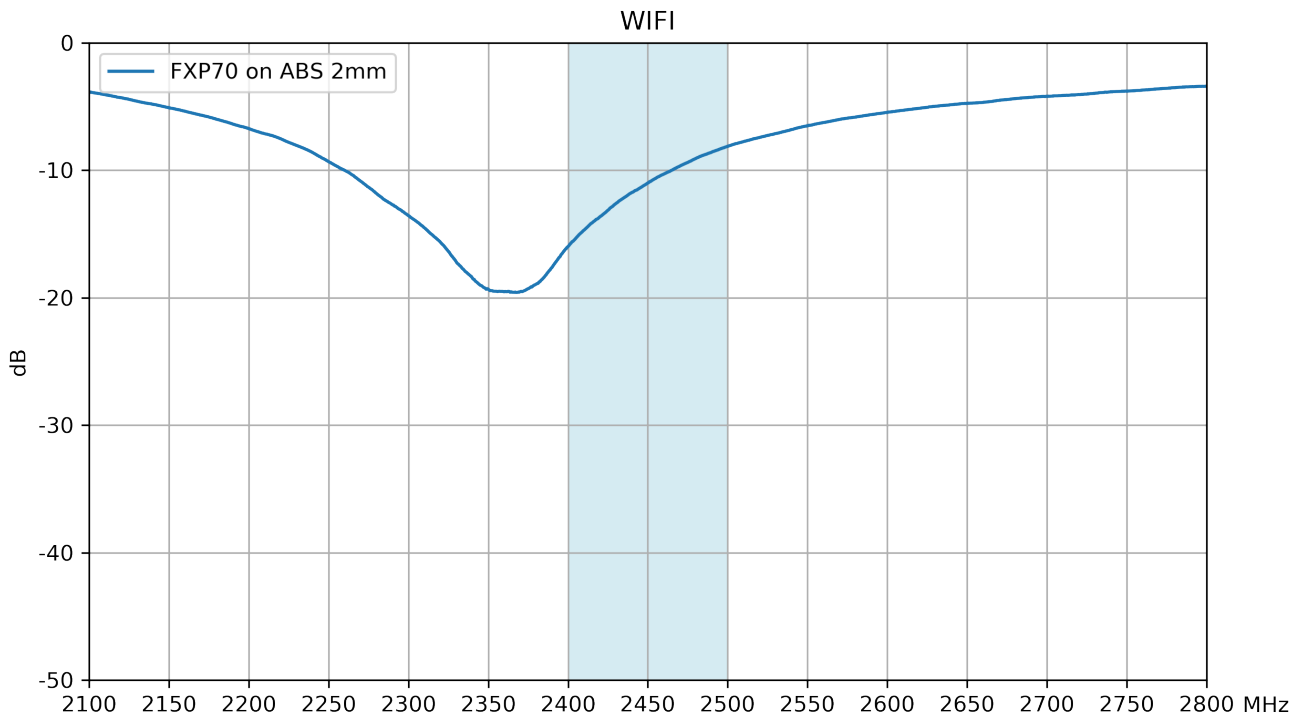

3.2 Efficiency

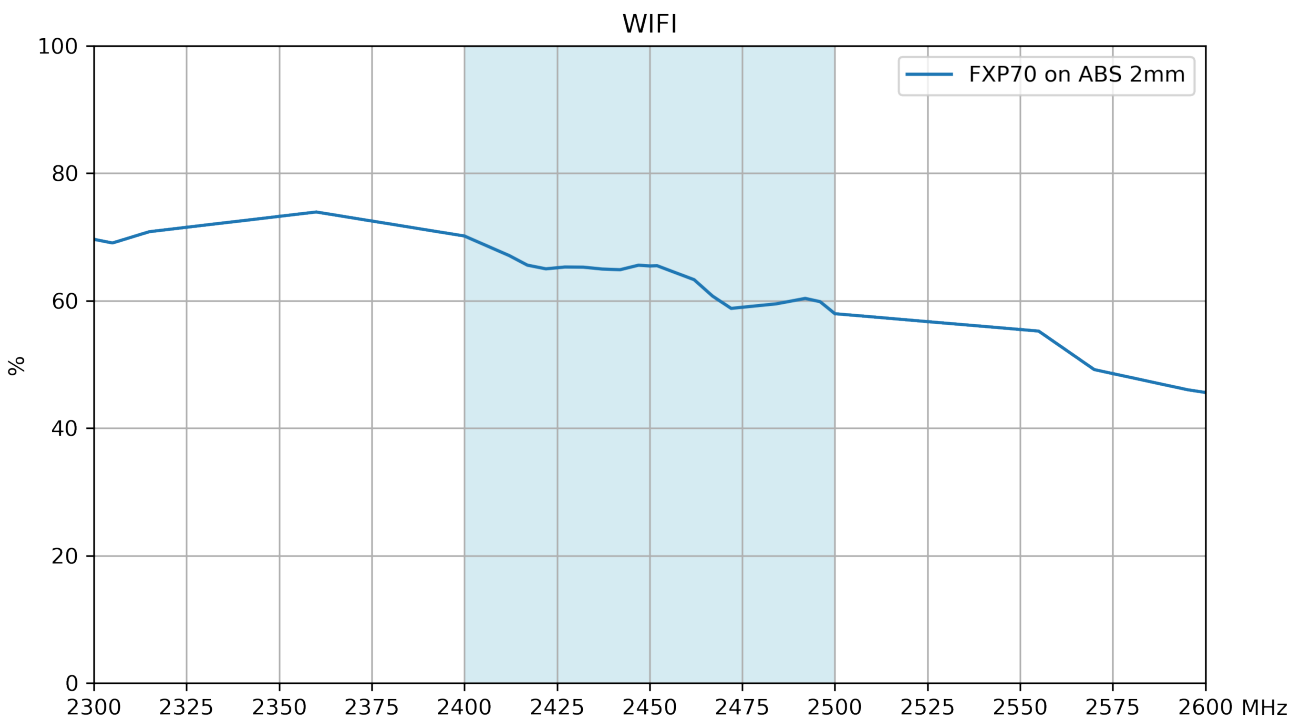

3.3 Average Gain

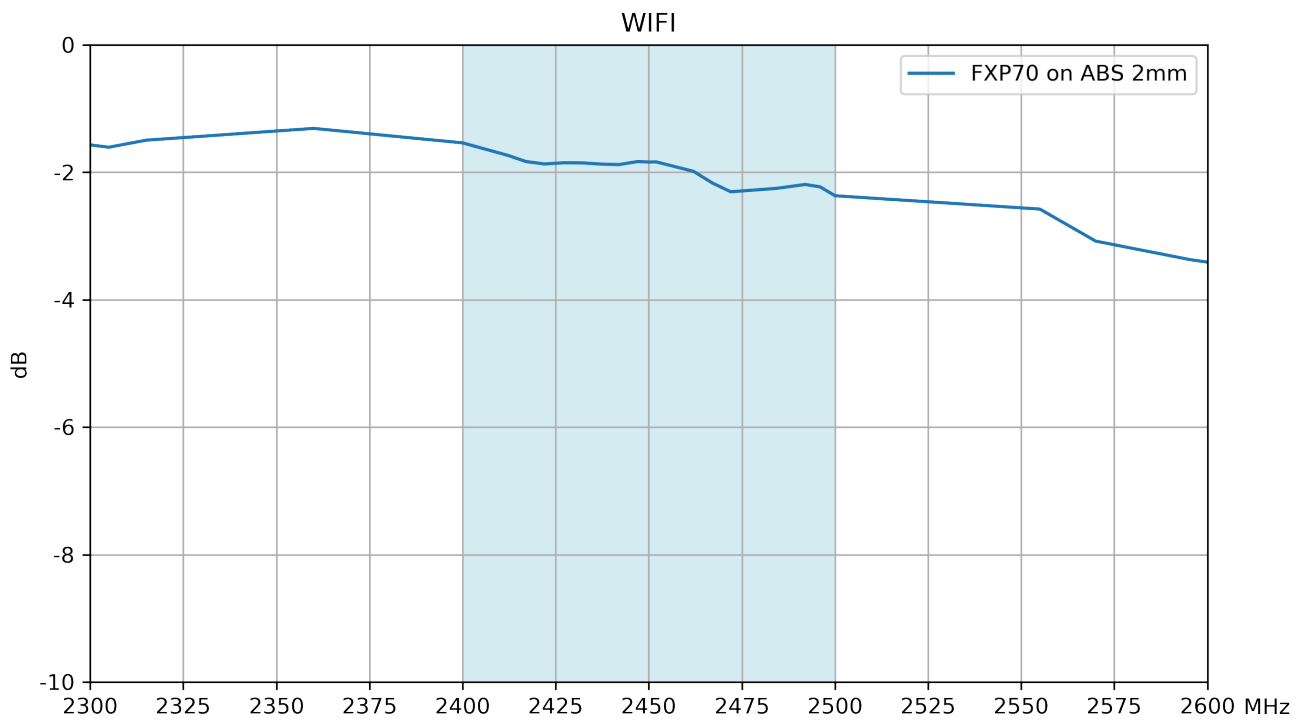

3.4 Peak Gain

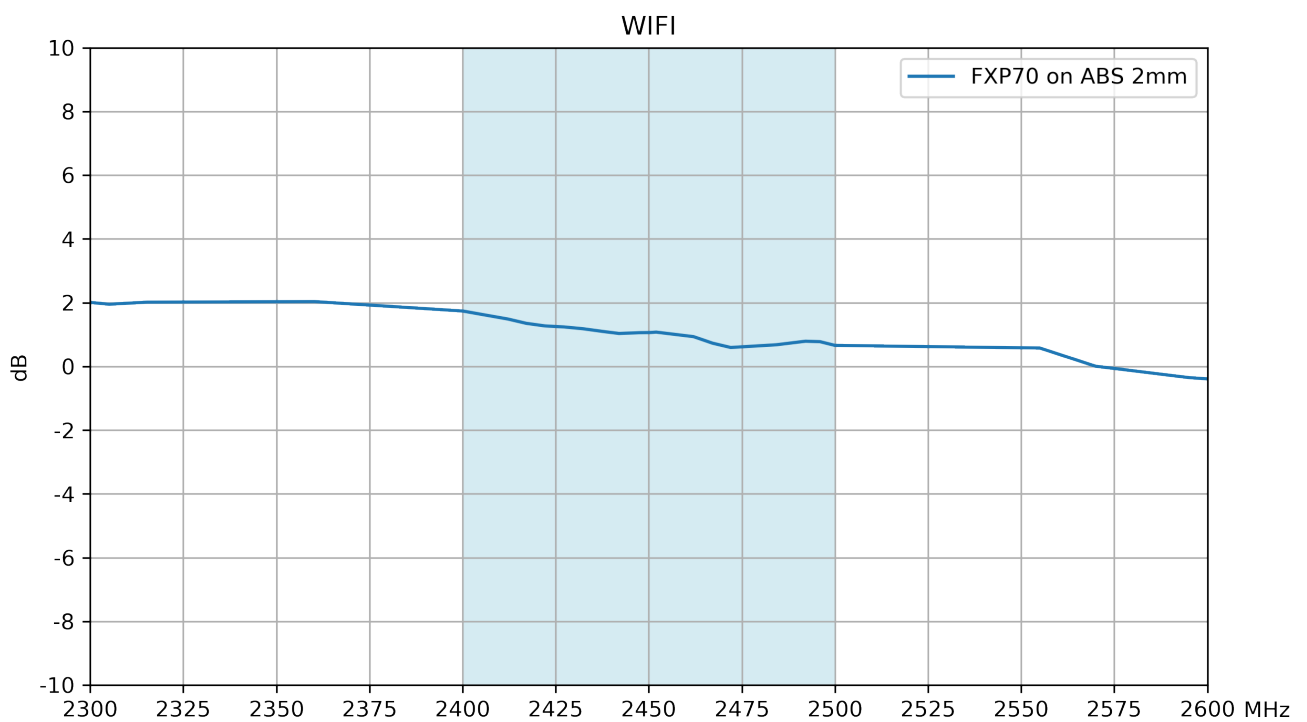

4. Radiation Patterns

4.1 Test Setup

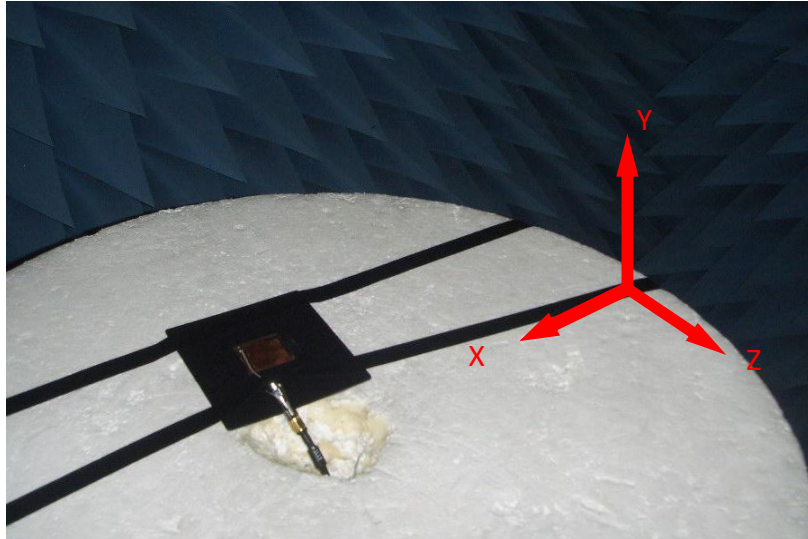

4.2 2450MHz 3D and 2D Radiation Patterns

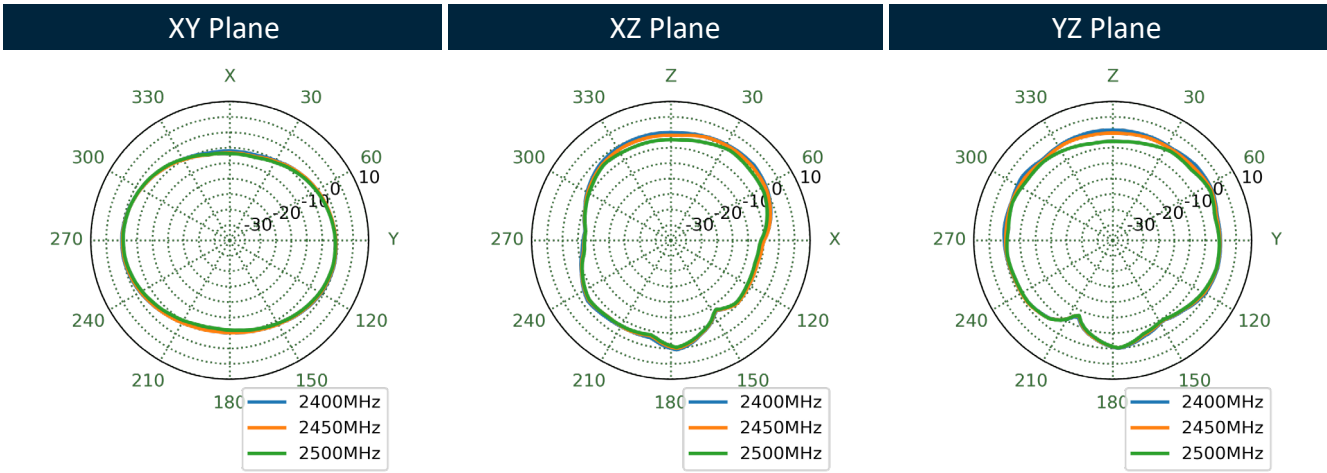
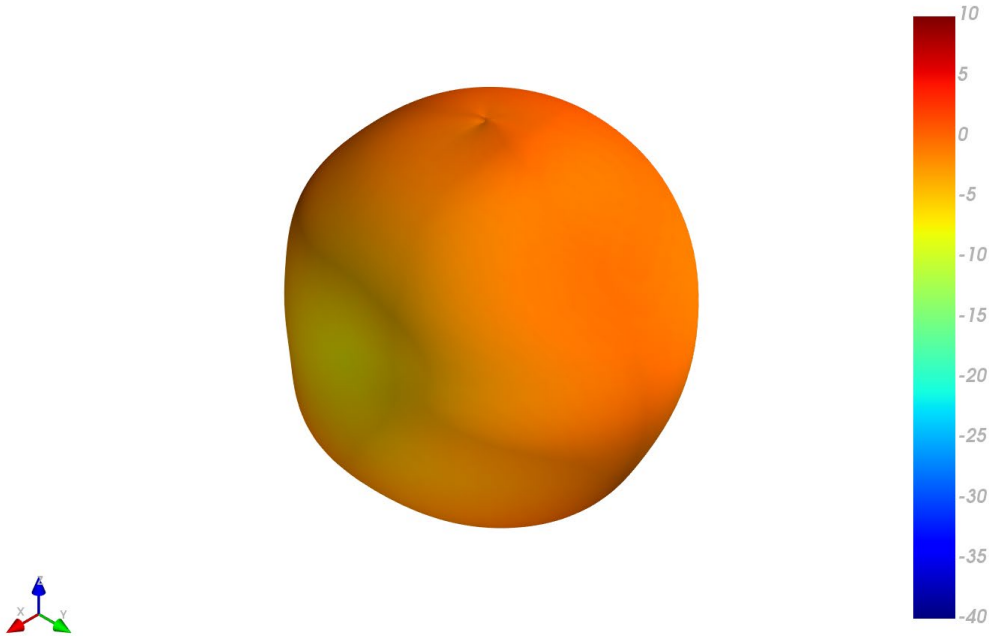

6. Packaging

100pcs FXP70.07.0053A per PE Bag
 Dimensions - 180*100mm
 Weight - 130g

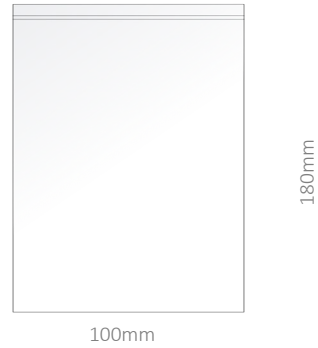

1000pcs FXP70.07.0053A per Large PE Bag
 Dimensions - 280*450mm
 Weight - 1.4Kg



6000pcs FXP70.07.0053A per carton
 Dimensions - 320*250*230mm
 Weight - 8.5Kg

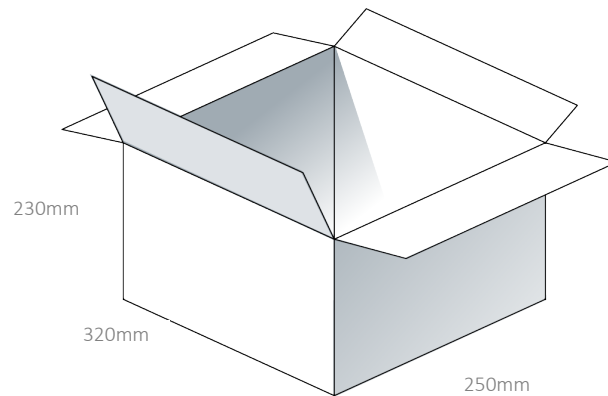

Changelog for the datasheet

SPE-12-8-013 - FXP70.07.0053A

Revision: G (Current Version)

Date:	2024-09-30
Changes:	Updated with new product image.
Changes Made by:	Conor McGrath

Previous Revisions

Revision: F

Date:	2019-12-13
Changes:	Updated with new data
Changes Made by:	Jack Conroy

Revision: A (Original First Release)

Date:	2012-06-02
Notes:	
Author:	Aine Doyle

Revision: E

Date:	2016-08-23
Changes:	Drawing updated
Changes Made by:	Andy Mahoney

Revision: D

Date:	2015-08-20
Changes:	Added note on Gain
Changes Made by:	Aine Doyle

Revision: C

Date:	2015-01-14
Changes:	Updated Intro
Changes Made by:	Andy Mahoney

Revision: B

Date:	2015-01-13
Changes:	Packaging Details Updated
Changes Made by:	Andy Mahoney



TAOGLAS®

www.taoglas.com



Looking for pricing, stock, or lifecycle information?

Click below to explore more details on WIN SOURCE:

- ⊖ [View FXP70.07.0053A on WIN SOURCE](#)
- ⊖ [Taoglas Limited Information](#)

Optimize Your Supply Chain with WIN SOURCE Solutions

- ✓ Global Sourcing Solution
- ✓ Obsolete Management
- ✓ Cost Control Management
- ✓ Shortage Management
- ✓ Alternative Solution
- ✓ Excess Inventory Management