

**HLMP-1600, HLMP-1601, HLMP-1620, HLMP-1621,  
HLMP-1640, HLMP-1641, HLMP-3600, HLMP-3601,  
HLMP-3650, HLMP-3651, HLMP-3680, HLMP-3681  
T-1 $\frac{3}{4}$  (5-mm), T-1 (3-mm), 5V, 12V, Integrated Resistor  
LED Lamps**



---

## Overview

The Broadcom<sup>®</sup> 5V and 12V series lamps contain an integral current limiting resistor in series with the LED. This allows the lamp to be driven from a 5V/12V source without an external current limiter.

The diffused lamps provide a wide off-axis viewing angle.

The T-1 $\frac{3}{4}$  lamps are provided with sturdy leads suitable for wire wrap applications. The T-1 $\frac{3}{4}$  lamps may be front panel mounted by using the HLMP-0103 clip and ring.

## Features

- Integral current limiting resistor
- TTL compatible
  - Requires no external current limiter with 5V/12V supply
- Cost effective
  - Saves space and resistor cost
- Wide viewing angle
- Available in all colors
  - Red, Yellow, and Green in T-1 and T-1 $\frac{3}{4}$  packages
- AllnGaP LED technology

# Package Dimensions

Figure 1: T-1 Package

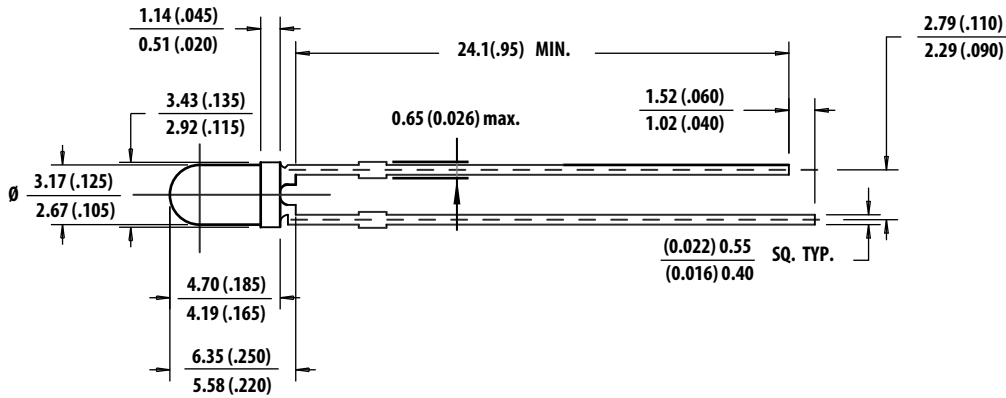
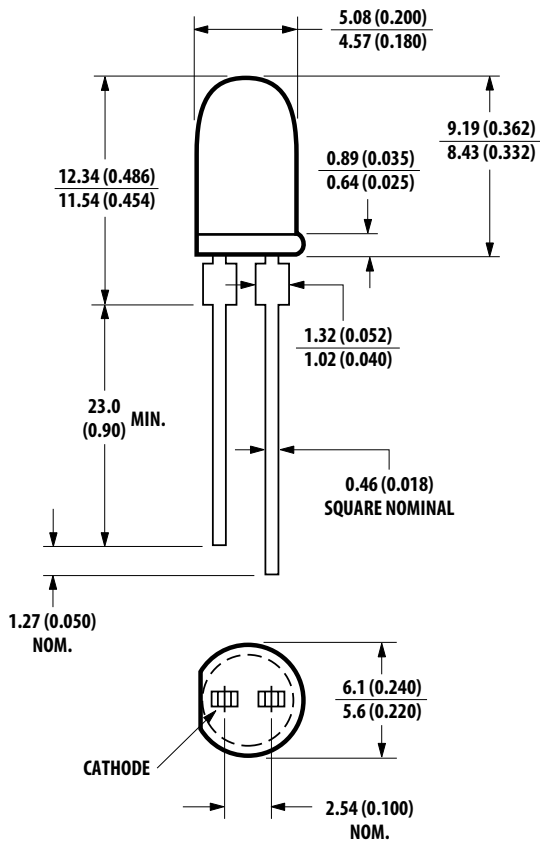

Figure 2: T-1¼ Package



**NOTE:**

1. All dimensions are in millimeters (inches).
2. An epoxy meniscus can extend about 1 mm (0.040 in.) down the leads.
3. For PCB hole recommendations, see the [Precautions](#) section.

## Device Selection Guide

Color	Package Description	Package Outline	$2\theta^{1/2}$ <sup>a</sup>	Operating Voltage (V)	Part Number HLMP-	Luminous Intensity $I_V$ (mcd)	
						Min.	Max.
Red	T-1 Tinted Diffused	Figure 1	60	5	1600	2.1	—
					1600-D00xx	2.1	—
			60	12	1601	2.1	—
	T-1¼ Tinted Diffused	Figure 2	60	5	3600	2.1	—
					3600-D00xx	2.1	—
			60	12	3601	2.1	—
Yellow	T-1 Tinted Diffused	Figure 1	60	5	1620	2.2	—
					1620-C00xx	2.2	—
			60	12	1621	2.2	—
	T-1¼ Tinted Diffused	Figure 2	60	5	3650	2.2	—
					3650-C00xx	2.2	—
			60	12	3651	2.2	—
Green	T-1 Tinted Diffused	Figure 1	60	5	1640	1.6	—
					1640-B00xx	1.6	—
			1640-FH0xx	10.6	54.6		
	T-1¼ Tinted Diffused	Figure 2	60	5	3680	1.6	—
					3680-B00xx	1.6	—
			60	12	3681	1.6	—
					3681-B00xx	1.6	—

a.  $\theta^{1/2}$  is the off-axis angle at which the luminous intensity is  $1/2$  the axial luminous intensity.

## Absolute Maximum Ratings

Parameter	Red/Yellow 5V Lamps	Red/Yellow 12V Lamps	Green 5V Lamps	Green 12V Lamps
DC Forward Voltage ( $T_A = 25^\circ\text{C}$ )	7.5V <sup>a</sup>	15V <sup>b</sup>	7.5V <sup>a</sup>	15V <sup>b</sup>
Reverse Voltage ( $I_R = 100 \mu\text{A}$ )	5V	5V	5V	5V
Operating Temperature Range	-40°C to +85°C		-20°C to +85°C	
Storage Temperature Range	-40°C to +100°C		-40°C to +100°C	

a. Derate from  $T_A = 50^\circ\text{C}$  at 0.071 V/°C; see Figure 6.

b. Derate from  $T_A = 50^\circ\text{C}$  at 0.086 V/°C; see Figure 7.

## Optical and Electrical Characteristics at $T_A = 25^\circ\text{C}$

Parameter	Symbol	Color	Min.	Typ.	Max.	Units	Test Conditions
Peak Wavelength	$\lambda_{\text{PEAK}}$	Red	—	632	—	nm	
		Yellow	—	590	—		
		Green	—	570	—		
Dominant Wavelength <sup>a</sup>	$\lambda_d$	Red	—	626	—	nm	
		Yellow	—	589	—		
		Green	—	569	—		
Spectrum Line Halfwidth	$\Delta\lambda_{1/2}$	Red	—	14	—	nm	
		Yellow	—	12	—		
		Green	—	13	—		
Thermal Resistance <sup>b</sup>	$R_{\theta\text{J-PIN}}$	Red	—	290	—	°C/W	Junction to Cathode Lead
		Yellow	—	290	—		
		Green	—	290	—		
Thermal Resistance <sup>c</sup>	$R_{\theta\text{J-PIN}}$	Red	—	210	—	°C/W	Junction to Cathode Lead
		Yellow	—	210	—		
		Green	—	210	—		
Forward Current, 12V Devices	$I_F$	Red	—	13	20	mA	$V_F = 12\text{V}$
		Yellow	—	13	20		
		Green	—	13	20		
Forward Current, 5V Devices	$I_F$	Red	—	10	15	mA	$V_F = 5\text{V}$
		Yellow	—	10	15		
		Green	—	10	15		
Luminous Efficacy <sup>d</sup>	$\eta_V$	Red	—	180	—	Lumen/ Watt	
		Yellow	—	500	—		
		Green	—	640	—		
Reverse Breakdown Voltage	$V_R$	Red	5	—	—	V	$I_R = 100\ \mu\text{A}$
		Yellow	5	—	—		
		Green	5	—	—		

- The dominant wavelength,  $\lambda_d$ , is derived from the Chromaticity diagram and represents the color of the lamp.
- For [Figure 1, T-1 Package](#), package type.
- For [Figure 2, T-1¼ Package](#), package type.
- Radiant intensity,  $I_e$ , in watts/steradian, can be found from the equation  $I_e = I_v / \eta_V$ , where  $I_v$  is the luminous intensity in candelas and  $\eta_V$  is the luminous efficacy in lumens/watt.

## Part Numbering System

H L M P - x<sub>1</sub> 6 x<sub>2</sub> x<sub>3</sub> - x<sub>4</sub> x<sub>5</sub> x<sub>6</sub> x<sub>7</sub> x<sub>8</sub>

Code	Description	Option	
x <sub>1</sub>	Package Type	1	T-1 (3 mm)
		3	T-1¼ (5 mm)
x <sub>2</sub>	Color	0	Red
		2, 5	Yellow
		4, 8	Green
x <sub>3</sub>	Operating Voltage	0	5V
		1	12V
x <sub>4</sub>	Minimum Intensity Bin	See the <a href="#">Intensity Bin Limits</a> table.	
x <sub>5</sub>	Maximum Intensity Bin	0	Open bins (no maximum I <sub>V</sub> bin limit)
x <sub>6</sub>	Color Bin Option	0	Full distribution
x <sub>7</sub> x <sub>8</sub>	Packaging Option	00	Bulk (loose forms packaging)
		A1, B1	Right angle housing, uneven leads
		A2, B2	Right angle housing, even leads

## Bin Information

### Intensity Bin Limits

Color	Bin	Intensity Range (mcd)	
		Min.	Max.
Red	D	2.4	3.8
	E	3.8	6.1
	F	6.1	9.7
	G	9.7	15.5
	H	15.5	24.8
	I	24.8	39.6
	J	39.6	63.4
	K	63.4	101.5
	L	101.5	162.4
	M	162.4	234.6
	N	234.6	340.0
	O	340.0	540.0
	P	540.0	850.0
	Q	850.0	1200.0
	R	1200.0	1700.0
	S	1700.0	2400.0
	T	2400.0	3400.0
	U	3400.0	4900.0
	V	4900.0	7100.0
	W	7100.0	10200.0
	X	10200.0	14800.0
Y	14800.0	21400.0	
Z	21400.0	30900.0	
Yellow	C	2.5	4.0
	D	4.0	6.5
	E	6.5	10.3
	F	10.3	16.6
	G	16.6	26.5
	H	26.5	42.3
	I	42.3	67.7
	J	67.7	108.2
	K	108.2	173.2
	L	173.2	250.0
	M	250.0	360.0
	N	360.0	510.0
	O	510.0	800.0
	P	800.0	1250.0
	Q	1250.0	1800.0
	R	1800.0	2900.0
	S	2900.0	4700.0
T	4700.0	7200.0	
U	7200.0	11700.0	
V	11700.0	18000.0	

Color	Bin	Intensity Range (mcd)	
		Min.	Max.
Yellow (cont.)	W	18000.0	27000.0
Green	B	1.8	2.9
	C	2.9	4.7
	D	4.7	7.6
	E	7.6	12.0
	F	12.0	19.1
	G	19.1	30.7
	H	30.7	49.1
	I	49.1	78.5
	J	78.5	125.7
	K	125.7	201.1
	L	201.1	289.0
	M	289.0	417.0
	N	417.0	680.0
	O	680.0	1100.0
	P	1100.0	1800.0
	Q	1800.0	2700.0
	R	2700.0	4300.0
	S	4300.0	6800.0
	T	6800.0	10800.0
	U	10800.0	16000.0
V	16000.0	25000.0	
W	25000.0	40000.0	

Maximum tolerance for each bin limit is  $\pm 18\%$ .

### Color Categories

Color	Category #	Lambda (nm)	
		Min.	Max.
Green	6	561.5	564.5
	5	564.5	567.5
	4	567.5	570.5
	3	570.5	573.5
	2	573.5	576.5
Yellow	1	582.0	584.5
	3	584.5	587.0
	2	587.0	589.5
	4	589.5	592.0
	5	592.0	593.0

Tolerance for each bin limit is  $\pm 0.5$  nm.

# Packaging Option Matrix

Packaging Option Code	Definition
00	Bulk Packaging, minimum increment 500 pieces/bag
A1	T-1, Right Angle Housing, uneven leads, minimum increment 500 pieces/bag
A2	T-1, Right Angle Housing, even leads, minimum increment 500 pieces/bag
B1	T-1¼ Right Angle Housing, uneven lead, minimum increment 500 pieces/bag
B2	T-1¼ Right Angle Housing, even leads, minimum increment 500 pieces/bag

**NOTE:** All categories are established for classification of products. Products might not be available in all categories. Contact your local Broadcom representative for further clarification or information.

**Figure 3: Relative Intensity vs. Wavelength**

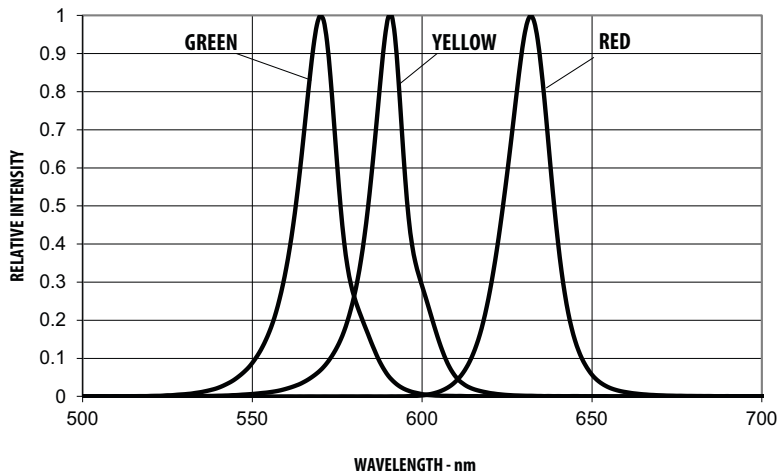

**Figure 4: Forward Current vs. Applied Forward Voltage, 5V Devices**

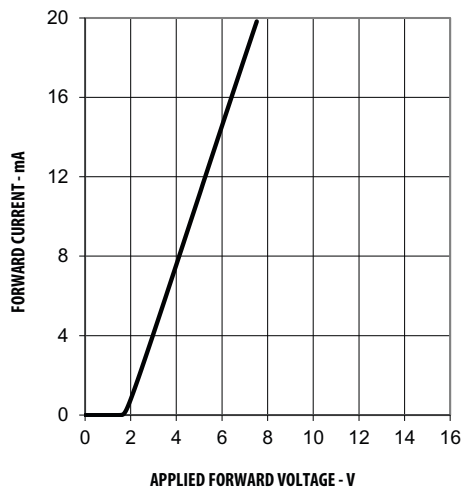

**Figure 5: Forward Current vs. Applied Forward Voltage, 12V Devices**

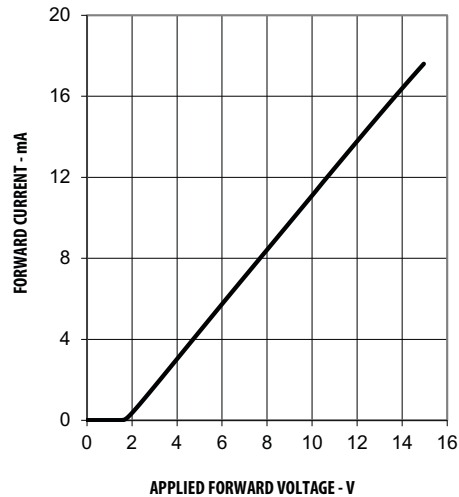

**Figure 6: Maximum Allowed Applied Forward Voltage vs. Ambient Temperature  $R\theta_{JA} = 175^{\circ}\text{C/W}$ , 5V Devices**

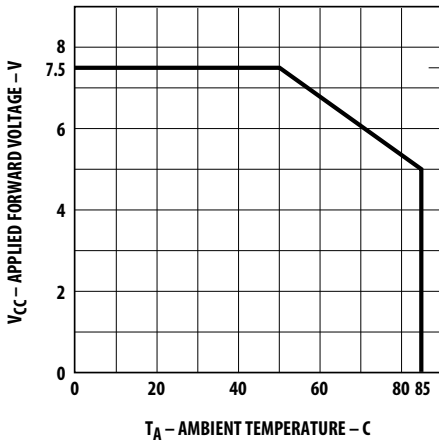

**Figure 7: Maximum Allowed Applied Forward Voltage vs. Ambient Temperature  $R\theta_{JA} = 175^{\circ}\text{C/W}$ , 12V Devices**

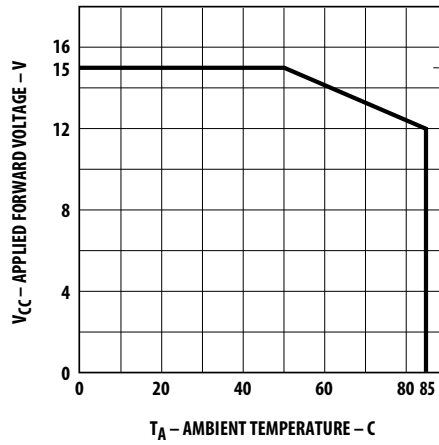

**Figure 8: Relative Luminous Intensity vs. Angular Displacement for T-1 Package**

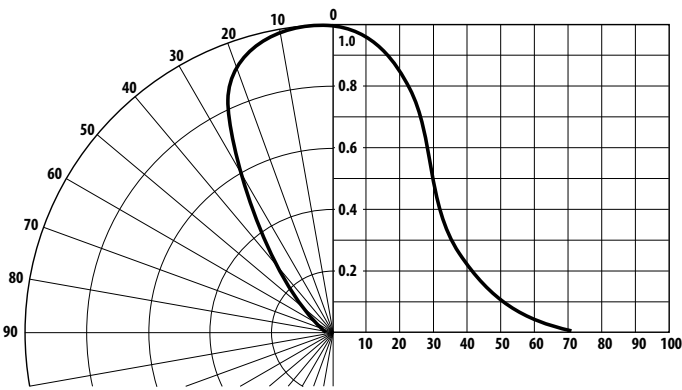

**Figure 9: Relative Luminous Intensity vs. Angular Displacement for T-1¼ Package**

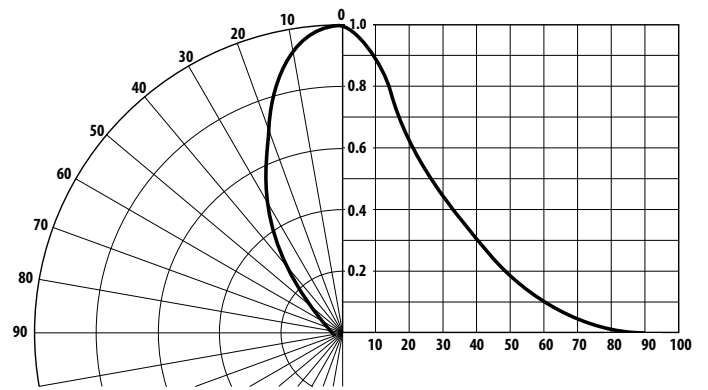

**Figure 10: Relative Luminous Intensity vs. Applied Forward Voltage, 5V Devices**

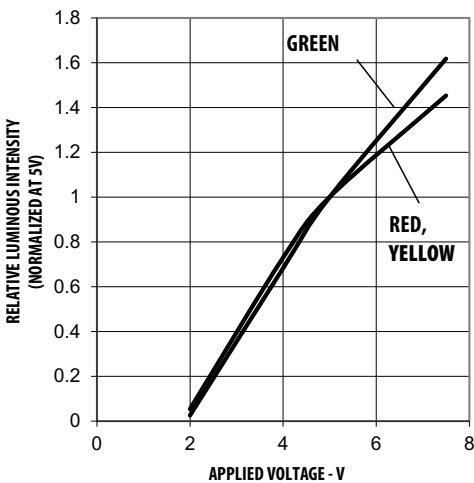

**Figure 11: Relative Luminous Intensity vs. Applied Forward Voltage, 12V Devices**

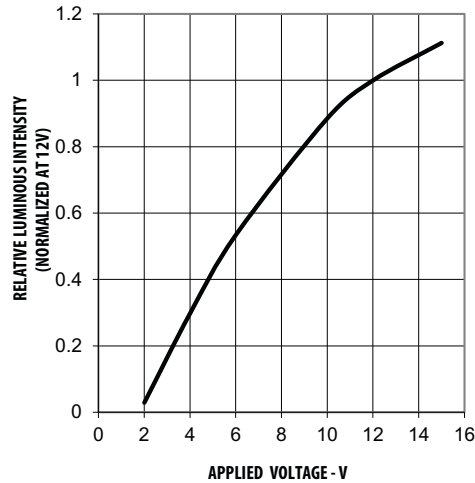

## Precautions

### Lead Forming

- The leads of an LED lamp may be preformed or cut to length prior to insertion and soldering on PC board.
- For better control, use the proper tool to precisely form and cut the leads to applicable length rather than doing it manually.
- If manual lead cutting is necessary, cut the leads after the soldering process. The solder connection forms a mechanical ground that prevents mechanical stress due to lead cutting from traveling into the LED package. Use this method for the hand soldering operation, because the excess lead length also acts as small heat sink.

### Soldering and Handling

- Take care during the PCB assembly and soldering process to prevent damage to the LED component.
- The LED component may be effectively hand soldered to the PCB. However, do this under unavoidable circumstances, such as rework. The closest manual soldering distance of the soldering heat source (soldering iron's tip) to the body is 1.59 mm. Soldering the LED using soldering iron tip closer than 1.59 mm might damage the LED.

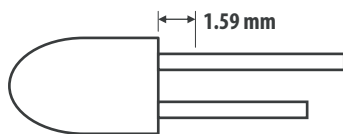

- Apply ESD precautions on the soldering station and personnel to prevent ESD damage to the LED component that is ESD sensitive. Refer to Broadcom application note AN 1142 for details. The soldering iron used must have a grounded tip to ensure electrostatic charge is properly grounded.
- Recommended soldering conditions:

	Wave Soldering <sup>a, b</sup>	Manual Solder Dipping
Pre-heat Temperature	105°C max.	—
Pre-heat Time	60s max.	—
Peak Temperature	250°C max.	260°C max.
Dwell Time	3s max.	5s max.

- The preceding conditions refer to measurement with a thermocouple mounted at the bottom of the PCB.
- Use only bottom pre-heaters to reduce thermal stress experienced by LED.

- Set and maintain wave soldering parameters according to the recommended temperature and dwell time. Perform daily checks on the soldering profile to ensure that it always conforms to the recommended soldering conditions.

#### NOTE:

- PCBs with different size and design (component density) will have a different heat mass (heat capacity). This might cause a change in temperature experienced by the board if the same wave soldering setting is used. Therefore, recalibrate the soldering profile again before loading a new type of PCB.
  - Take extra precautions during wave soldering to ensure that the maximum wave temperature does not exceed 250°C and the solder contact time does not exceed 3s. Overstressing the LED during the soldering process might cause premature failure to the LED due to delamination.
- Loosely fit any alignment fixture that is being applied during wave soldering and do not apply weight or force on the LED. Use non-metal material because it will absorb less heat during the wave soldering process.
  - At elevated temperature, the LED is more susceptible to mechanical stress. Therefore, allow the PCB to cool down to room temperature prior to handling, which includes removal of alignment fixture or pallet.
  - If the PCB board contains both through-hole (TH) LED and other surface-mount components, solder surface-mount components on the top side of the PCB. If the surface mount must be on the bottom side, solder these components using reflow soldering prior to the insertion of the TH LED.
  - The recommended PC board plated through holes (PTH) size for LED component leads follows:

	LED Component Lead Size	Diagonal	Plated Through-Hole Diameter
Lead size (typ.)	0.45 × 0.45 mm (0.018 × 0.018 in.)	0.636 mm (0.025 in.)	0.98 to 1.08 mm (0.039 to 0.043 in.)
Dambar shear-off area (max.)	0.65 mm (0.026 in.)	0.919 mm (0.036 in.)	
Lead size (typ.)	0.50 × 0.50 mm (0.020 × 0.020 in.)	0.707 mm (0.028 in.)	1.05 to 1.15 mm (0.041 to 0.045 in.)
Dambar shear-off area (max.)	0.70 mm (0.028 in.)	0.99 mm (0.039 in.)	

- Oversizing the PTH can lead to a twisted LED after clinching. On the other hand, undersizing the PTH can cause difficulty inserting the TH LED.

Refer to application note AN1027 for more information about soldering and handling of TH LED lamps.

Figure 12: Recommended Wave Soldering Profile

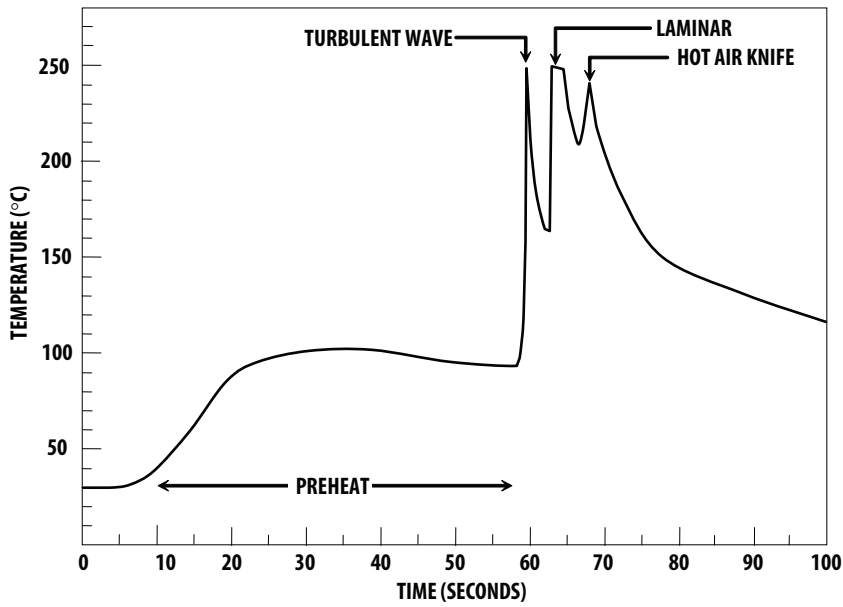

Recommended solder:  
Sn63 (Leaded solder alloy)  
SAC305 (Lead-free solder alloy)

Flux: Rosin flux

Solder bath temperature:  
245°C ± 5 °C (maximum peak temperature = 250°C)

Dwell time: 1.5s – 3.0s (maximum = 3 seconds)

Note: Allow for board to be sufficiently cooled to room temperature before you exert mechanical force.

## Disclaimer

Broadcom's products and software are not specifically designed, manufactured, or authorized for sale as parts, components, or assemblies for the planning, construction, maintenance, or direct operation of a nuclear facility or for use in medical devices or applications. The customer is solely responsible, and waives all rights to make claims against Broadcom or its suppliers, for all loss, damage, expense, or liability in connection with such use.

Copyright © 2015-2022 Broadcom. All Rights Reserved. The term "Broadcom" refers to Broadcom Inc. and/or its subsidiaries. For more information, go to [www.broadcom.com](http://www.broadcom.com). All trademarks, trade names, service marks, and logos referenced herein belong to their respective companies.

Broadcom reserves the right to make changes without further notice to any products or data herein to improve reliability, function, or design. Information furnished by Broadcom is believed to be accurate and reliable. However, Broadcom does not assume any liability arising out of the application or use of this information, nor the application or use of any product or circuit described herein, neither does it convey any license under its patent rights nor the rights of others.



Lead (Pb) Free  
RoHS Compliant

## Looking for pricing, stock, or lifecycle information?

Click below to explore more details on WIN SOURCE:

- [⊖ View HLMP-1640-B00A1 on WIN SOURCE](#)
- [⊖ Broadcom Limited Information](#)

## Optimize Your Supply Chain with WIN SOURCE Solutions

- ✓ Global Sourcing Solution
- ✓ Obsolete Management
- ✓ Cost Control Management
- ✓ Shortage Management
- ✓ Alternative Solution
- ✓ Excess Inventory Management