



**THE DATASHEET OF  
HFCW-8400+**





CERAMIC

# High Pass Filter

## HFCW-8400+

50Ω 9200 to 18000 MHz

### THE BIG DEAL

- Low loss, 0.9 dB typ.
- Return loss, 11 dB typ.
- Stop Band Rejection, 36 dB typ.
- Small size 0603 (0.063" x 0.032" x 0.024")



Generic photo used for illustration purposes only

CASE STYLE: JC0603C

#### +RoHS Compliant

The +Suffix identifies RoHS Compliance. See our web site for RoHS Compliance methodologies and qualifications

### APPLICATIONS

- Test and measurements
- Military applications
- Telecommunications and broadband wireless systems

### PRODUCT OVERVIEW

HFCW-8400+ is a high pass filter with passband from 9200 MHz to 18000 MHz supporting a variety of applications. This model provides good insertion loss over a wide band due to strategically constructed layout. Housed in a tiny 0603 ceramic form factor with wraparound terminations, the filter is ideal for dense PCB layouts.

### KEY FEATURES

Feature	Advantages
Wide passband	This filter has a very wide passband from 9.2 GHz to 18 GHz.
LTCC Construction	Provides repeatable performance in a rugged, ceramic package well suited for tough environments such as high humidity and temperature extremes.
Small size, 0603 (0.063" X 0.032" X 0.024")	Saves space in dense circuit board layouts and minimizes the effects of parasitics.
Wrap-around terminations	Provides excellent solderability and easy visual inspection.

REV. OR  
ECO-015161  
HFCW-8400+  
EDU4353  
URJ  
220924





CERAMIC

# High Pass Filter

## HFCW-8400+

### ELECTRICAL SPECIFICATIONS<sup>1,2</sup> AT 25°C

Parameter		F#	Frequency (MHz)	Min.	Typ.	Max.	Units
Stopband	Rejection Loss	DC-F1	DC - 5200	29	36	—	dB
		F1-F2	5200 - 6500	23	37	—	dB
	Freq. Cut-Off	F3*	8400	—	3	—	dB
Passband	Insertion Loss	F4-F5	9200 - 11500	—	1.8	—	dB
		F5-F6	11500 - 17000	—	0.9	1.6	dB
		F6-F7	17000 - 18000	—	1.8	—	dB
	Return Loss	F4-F5	9200 - 11500	—	11	—	dB
		F5-F6	11500 - 17000	—	11	—	dB
		F6-F7	17000 - 18000	—	8	—	dB

1 This component should not be employed as a DC-block. DC de-coupling capacitors are required in Applications where DC voltage and/or current is present at either input or output ports. Please contact Mini-Circuits for further support.

2 Measured on Mini-Circuits Characterization Test Board TB-HFCW-8400+

\* Typically, a ±5% frequency deviation from the stated value may occur on a unit-to-unit basis.

### MAXIMUM RATINGS

Parameter	Ratings
Operating temperature	-55°C to 125°C
Storage temperature	-55°C to 125°C
RF Power Input*	2.5W @25°C

\*Passband rating, derate linearly to 0.6W at 125°C ambient  
Permanent damage may occur if any of these limits are exceeded.

### TYPICAL FREQUENCY RESPONSE

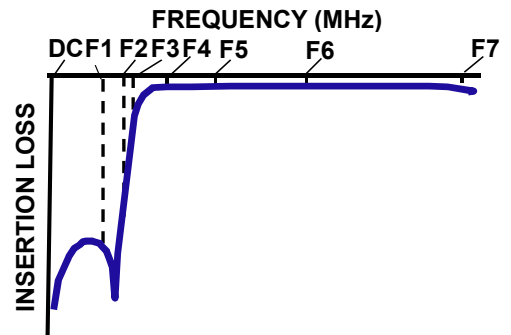

### FUNCTIONAL SCHEMATIC

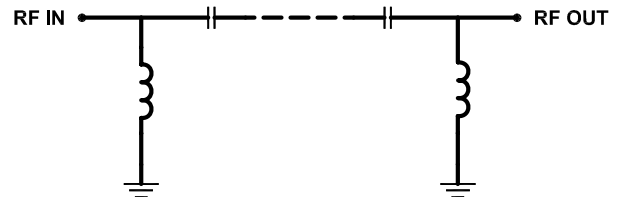



CERAMIC

# High Pass Filter

HFCW-8400+

### PAD CONNECTIONS

INPUT	1
OUTPUT	3
GROUND	2,4,5,6

PRODUCT MARKING: VB

DEMO BOARD MCL P/N: TB-HFCW-8400+  
SUGGESTED PCB LAYOUT (PL-704)

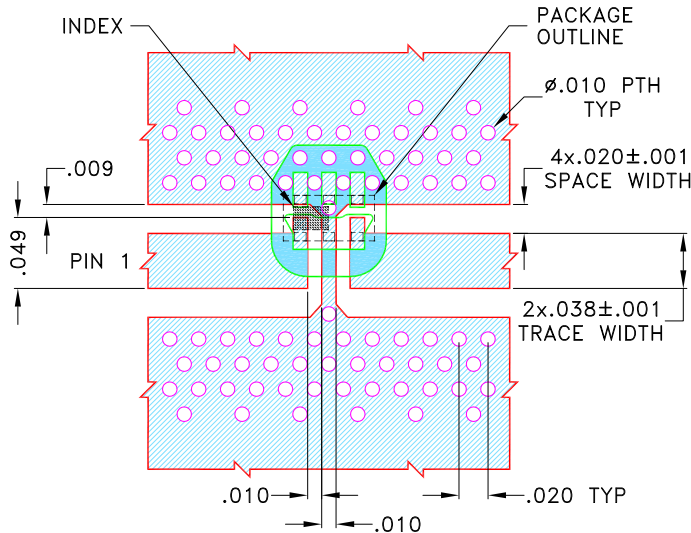

NOTES:

1. COPLANAR WAVEGUIDE PARAMETERS ARE SHOWN FOR ROGERS (R03003) WITH DIELECTRIC THICKNESS .020±.001 COPPER: 1/2 Oz. EACH SIDE. FOR OTHER MATERIALS TRACE WIDTH AND GAP MAY NEED TO BE MODIFIED.
  2. BOTTOM SIDE OF THE PCB IS CONTINUOUS GROUND PLANE.
- DENOTES PCB COPPER PATTERN WITH SMOBC (SOLDER MASK OVER BARE COPPER)  
 DENOTES PCB COPPER PATTERN FREE OF SOLDERMASK

### OUTLINE DRAWING

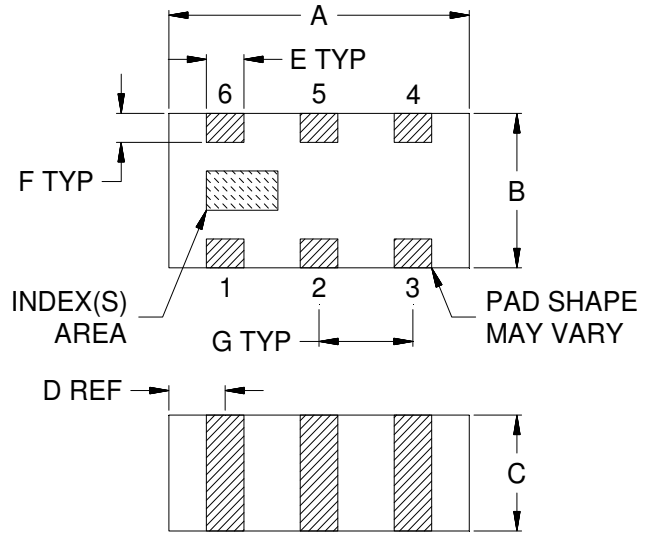

### OUTLINE DIMENSIONS (Inches/mm)

A	B	C	D	E	F	G	Wt.
.063	.032	.024	.012	.008	.006	.020	grams
1.60	0.80	0.60	0.30	0.20	0.15	0.50	.005

Note: Please refer to case style drawing for details



CERAMIC

# High Pass Filter

## HFCW-8400+

### TYPICAL PERFORMANCE DATA AT 25°C

Frequency (MHz)	Insertion Loss (dB)	Return Loss (dB)
10	76.70	0.06
100	61.42	0.07
3000	36.55	0.04
5200	38.35	0.09
6500	39.32	0.33
6800	31.38	0.45
7300	21.22	0.78
7900	9.82	2.29
8400	2.97	9.72
9200	1.16	24.73
10000	0.82	32.13
11500	0.60	22.24
15000	0.56	20.93
17000	0.48	22.24
18000	0.48	21.80

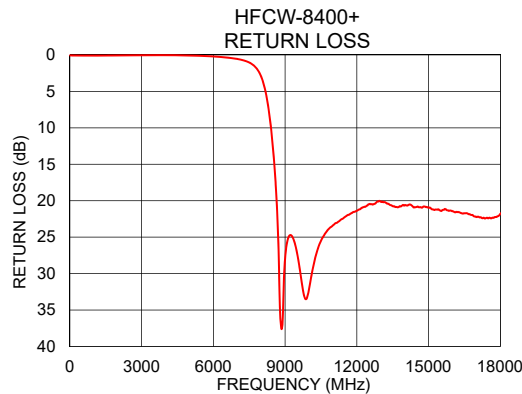
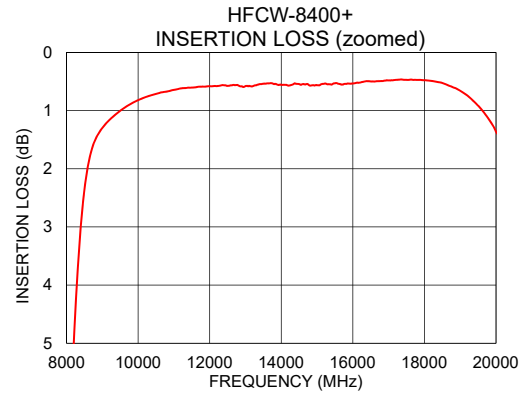
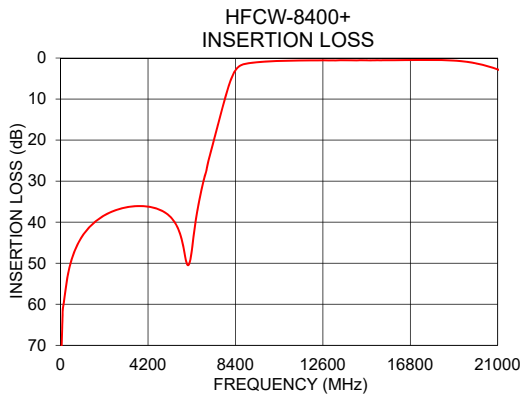



#### NOTES

- A. Performance and quality attributes and conditions not expressly stated in this specification document are intended to be excluded and do not form a part of this specification document.
- B. Electrical specifications and performance data contained in this specification document are based on Mini-Circuit's applicable established test performance criteria and measurement instructions.
- C. The parts covered by this specification document are subject to Mini-Circuits standard limited warranty and terms and conditions (collectively, "Standard Terms"); Purchasers of this part are entitled to the rights and benefits contained therein. For a full statement of the standard. Terms and the exclusive rights and remedies thereunder, please visit Mini-Circuits' website at [www.minicircuits.com/MCLStore/terms.jsp](http://www.minicircuits.com/MCLStore/terms.jsp)



## Looking for pricing, stock, or lifecycle information?

Click below to explore more details on WIN SOURCE:

-  [View HFCW-8400+ on WIN SOURCE](#)
-  [Mini-Circuits Information](#)

## Optimize Your Supply Chain with WIN SOURCE Solutions

-  Global Sourcing Solution
-  Obsolete Management
-  Cost Control Management
-  Shortage Management
-  Alternative Solution
-  Excess Inventory Management