



**THE DATASHEET OF
FDC6320C**



ON Semiconductor

Is Now

onsemi™

To learn more about onsemi™, please visit our website at
www.onsemi.com

onsemi and **onsemi** and other names, marks, and brands are registered and/or common law trademarks of Semiconductor Components Industries, LLC dba "**onsemi**" or its affiliates and/or subsidiaries in the United States and/or other countries. **onsemi** owns the rights to a number of patents, trademarks, copyrights, trade secrets, and other intellectual property. A listing of **onsemi** product/patent coverage may be accessed at www.onsemi.com/site/pdf/Patent-Marking.pdf. **onsemi** reserves the right to make changes at any time to any products or information herein, without notice. The information herein is provided "as-is" and **onsemi** makes no warranty, representation or guarantee regarding the accuracy of the information, product features, availability, functionality, or suitability of its products for any particular purpose, nor does **onsemi** assume any liability arising out of the application or use of any product or circuit, and specifically disclaims any and all liability, including without limitation special, consequential or incidental damages. Buyer is responsible for its products and applications using **onsemi** products, including compliance with all laws, regulations and safety requirements or standards, regardless of any support or applications information provided by **onsemi**. "Typical" parameters which may be provided in **onsemi** data sheets and/or specifications can and do vary in different applications and actual performance may vary over time. All operating parameters, including "Typicals" must be validated for each customer application by customer's technical experts. **onsemi** does not convey any license under any of its intellectual property rights nor the rights of others. **onsemi** products are not designed, intended, or authorized for use as a critical component in life support systems or any FDA Class 3 medical devices or medical devices with a same or similar classification in a foreign jurisdiction or any devices intended for implantation in the human body. Should Buyer purchase or use **onsemi** products for any such unintended or unauthorized application, Buyer shall indemnify and hold **onsemi** and its officers, employees, subsidiaries, affiliates, and distributors harmless against all claims, costs, damages, and expenses, and reasonable attorney fees arising out of, directly or indirectly, any claim of personal injury or death associated with such unintended or unauthorized use, even if such claim alleges that **onsemi** was negligent regarding the design or manufacture of the part. **onsemi** is an Equal Opportunity/Affirmative Action Employer. This literature is subject to all applicable copyright laws and is not for resale in any manner. Other names and brands may be claimed as the property of others.



ON Semiconductor®

FDC6320C

Dual N & P Channel , Digital FET

General Description

These dual N & P Channel logic level enhancement mode field effect transistors are produced using ON Semiconductor's proprietary, high cell density, DMOS technology. This very high density process is especially tailored to minimize on-state resistance. The device is an improved design especially for low voltage applications as a replacement for bipolar digital transistors in load switching applications. Since bias resistors are not required, this dual digital FET can replace several digital transistors with difference bias resistors.

Features

- N-Ch 25 V, 0.22 A, $R_{DS(ON)} = 5 \Omega @ V_{GS} = 2.7 V$.
- P-Ch 25 V, -0.12 A, $R_{DS(ON)} = 13 \Omega @ V_{GS} = -2.7 V$.
- Very low level gate drive requirements allowing direct operation in 3 V circuits. $V_{GS(th)} < 1.5 V$.
- Gate-Source Zener for ESD ruggedness. >6kV Human Body Model
- Replace NPN & PNP digital transistors.

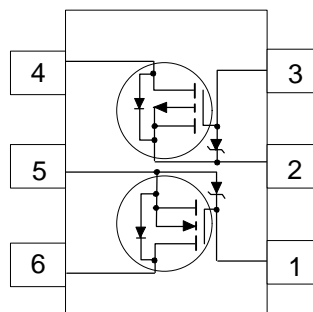
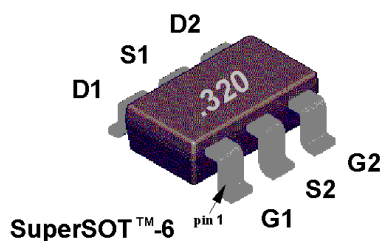

Absolute Maximum Ratings $T_A = 25^\circ\text{C}$ unless other wise noted

Symbol	Parameter	N-Channel	P-Channel	Units
V_{DSS}, V_{CC}	Drain-Source Voltage, Power Supply Voltage	25	-25	V
V_{GSS}, V_{IN}	Gate-Source Voltage,	8	-8	V
I_D, I_O	Drain/Output Current	- Continuous	-0.12	A
		- Pulsed	-0.5	
P_D	Maximum Power Dissipation	(Note 1a)	0.9	W
		(Note 1b)	0.7	
T_J, T_{STG}	Operating and Storage Temperature Ranger	-55 to 150		$^\circ\text{C}$
ESD	Electrostatic Discharge Rating MIL-STD-883D Human Body Model (100pf / 1500 Ohm)	6		kV

THERMAL CHARACTERISTICS

Symbol	Parameter	Units
$R_{\theta JA}$	Thermal Resistance, Junction-to-Ambient (Note 1a)	$140 \text{ }^\circ\text{C/W}$
$R_{\theta JC}$	Thermal Resistance, Junction-to-Case (Note 1)	$60 \text{ }^\circ\text{C/W}$

DMOS Electrical Characteristics ($T_A = 25\text{ }^\circ\text{C}$ unless otherwise noted)

Symbol	Parameter	Conditions	Type	Min	Typ	Max	Units
OFF CHARACTERISTICS							
BV_{DSS}	Drain-Source Breakdown Voltage	$V_{GS} = 0\text{ V}, I_D = 250\text{ }\mu\text{A}$	N-Ch	25			V
		$V_{GS} = 0\text{ V}, I_D = -250\text{ }\mu\text{A}$	P-Ch	-25			
$\Delta BV_{DSS}/\Delta T_J$	Breakdown Voltage Temp. Coefficient	$I_D = 250\text{ }\mu\text{A}$, Referenced to $25\text{ }^\circ\text{C}$	N-Ch		25		$\text{mV}/^\circ\text{C}$
		$I_D = -250\text{ }\mu\text{A}$, Referenced to $25\text{ }^\circ\text{C}$	P-Ch		-20		
I_{DSS}	Zero Gate Voltage Drain Current	$V_{DS} = 20\text{ V}, V_{GS} = 0\text{ V}$, $T_J = 55\text{ }^\circ\text{C}$	N-Ch			1 10	μA
		$V_{DS} = -20\text{ V}, V_{GS} = 0\text{ V}$, $T_J = 55\text{ }^\circ\text{C}$	P-Ch			-1 -10	
I_{GSS}	Gate - Body Leakage Current	$V_{GS} = 8\text{ V}, V_{DS} = 0\text{ V}$	N-Ch			100	nA
		$V_{GS} = -8\text{ V}, V_{DS} = 0\text{ V}$	P-Ch			-100	nA
ON CHARACTERISTICS (Note 2)							
$\Delta V_{GS(th)}/\Delta T_J$	Gate Threshold Voltage Temp. Coefficient	$I_D = 250\text{ }\mu\text{A}$, Referenced to $25\text{ }^\circ\text{C}$	N-Ch		-2.1		$\text{mV}/^\circ\text{C}$
		$I_D = -250\text{ }\mu\text{A}$, Referenced to $25\text{ }^\circ\text{C}$	P-Ch		1.9		
$V_{GS(th)}$	Gate Threshold Voltage	$V_{DS} = V_{GS}, I_D = 250\text{ }\mu\text{A}$	N-Ch	0.65	0.85	1.5	V
		$V_{DS} = V_{GS}, I_D = -250\text{ }\mu\text{A}$	P-Ch	-0.65	-1	-1.5	
$R_{DS(on)}$	Static Drain-Source On-Resistance	$V_{GS} = 2.7\text{ V}, I_D = 0.2\text{ A}$, $T_J = 125\text{ }^\circ\text{C}$	N-Ch		3.8	5	Ω
		$V_{GS} = 4.5\text{ V}, I_D = 0.4\text{ A}$			6.3	9	
		$V_{GS} = -2.7\text{ V}, I_D = -0.05\text{ A}$, $T_J = 125\text{ }^\circ\text{C}$		P-Ch		10.6	
		$V_{GS} = -4.5\text{ V}, I_D = -0.2\text{ A}$			15	21	
					7.9	10	
$I_{D(on)}$	On-State Drain Current	$V_{GS} = 2.7\text{ V}, V_{DS} = 5\text{ V}$	N-Ch	0.2			A
		$V_{GS} = -2.7\text{ V}, V_{DS} = -5\text{ V}$	P-Ch	-0.05			
g_{FS}	Forward Transconductance	$V_{DS} = 5\text{ V}, I_D = 0.4\text{ A}$	N-Ch		0.2		S
		$V_{DS} = -5\text{ V}, I_D = -0.2\text{ A}$	P-Ch		0.135		
DYNAMIC CHARACTERISTICS							
C_{iss}	Input Capacitance	N-Channel $V_{DS} = 10\text{ V}, V_{GS} = 0\text{ V}$, $f = 1.0\text{ MHz}$	N-Ch		9.5		pF
			P-Ch		11		
C_{oss}	Output Capacitance	P-Channel $V_{DS} = -10\text{ V}, V_{GS} = 0\text{ V}$, $f = 1.0\text{ MHz}$	N-Ch		6		pF
			P-Ch		7		
C_{rss}	Reverse Transfer Capacitance		N-Ch		1.3		pF
			P-Ch		1.4		

DMOS Electrical Characteristics ($T_A = 25\text{ }^\circ\text{C}$ unless otherwise noted)

Symbol	Parameter	Conditions	Type	Min	Typ	Max	Units
SWITCHING CHARACTERISTICS (Note 2)							
$t_{D(on)}$	Turn - On Delay Time	N-Channel $V_{DD} = 6\text{ V}, I_D = 0.5\text{ A},$ $V_{GS} = 4.5\text{ V}, R_{GEN} = 50\text{ }\Omega$	N-Ch		5	11	nS
			P-Ch		6	12	
t_r	Turn - On Rise Time		N-Ch		4.5	10	nS
			P-Ch		6	12	
$t_{D(off)}$	Turn - Off Delay Time	P-Channel $V_{DD} = -6\text{ V}, I_D = -0.5\text{ A},$ $V_{GEN} = -4.5\text{ V}, R_{GEN} = 50\text{ }\Omega$	N-Ch		4	10	nS
			P-Ch		7.4	15	
t_f	Turn - Off Fall Time		N-Ch		3.2	8	nS
			P-Ch		4	10	
Q_g	Total Gate Charge	N-Channel $V_{DS} = 5\text{ V},$ $I_D = 0.2\text{ A}, V_{GS} = 4.5\text{ V}$	N-Ch		0.29	0.4	nC
			P-Ch		0.23	0.32	
Q_{gs}	Gate-Source Charge	P-Channel $V_{DS} = -5\text{ V},$ $I_D = -0.2\text{ A}, V_{GS} = -4.5\text{ V}$	N-Ch		0.105		nC
			P-Ch		0.12		
Q_{gd}	Gate-Drain Charge		N-Ch		0.045		nC
			P-Ch		0.03		
DRAIN-SOURCE DIODE CHARACTERISTICS AND MAXIMUM RATINGS							
I_S	Maximum Continuous Drain-Source Diode Forward Current		N-Ch			0.5	A
			P-Ch			-0.5	
V_{SD}	Drain-Source Diode Forward Voltage	$V_{GS} = 0\text{ V}, I_S = 0.5\text{ A}$ (Note 2)	N-Ch		0.97	1.3	V
		$V_{GS} = 0\text{ V}, I_S = -0.5\text{ A}$ (Note 2)	P-Ch		-1	-1.3	

Notes:

- $R_{\theta JA}$ is the sum of the junction-to-case and case-to-ambient thermal resistance where the case thermal reference is defined as the solder mounting surface of the drain pins. $R_{\theta JC}$ is guaranteed by design while $R_{\theta CA}$ is determined by the user's board design.

Typical $R_{\theta JA}$ using the board layouts shown below on FR-4 PCB in a still air environment:

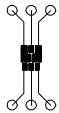

a. 140°C/W on a 0.125 in^2 pad of 2oz copper.

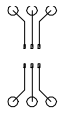

b. 180°C/W on a 0.005 in^2 pad of 2oz copper.

Scale 1 : 1 on letter size paper

- Pulse Test: Pulse Width $\leq 300\mu\text{s}$, Duty Cycle $\leq 2.0\%$.

Typical Electrical Characteristics: N-Channel

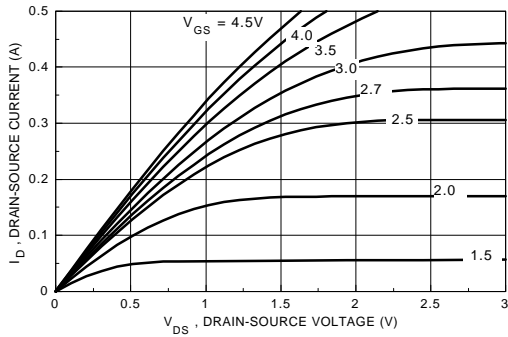

Figure 1. On-Region Characteristics.

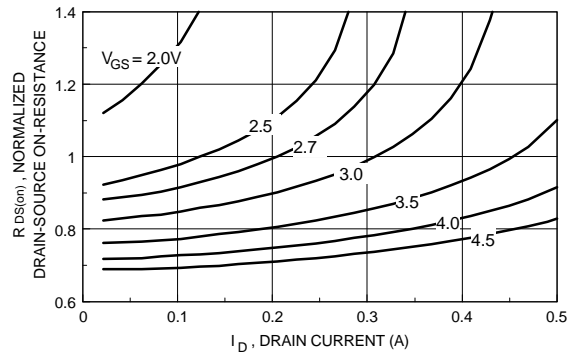

Figure 2. On-Resistance Variation with Drain Current and Gate Voltage.

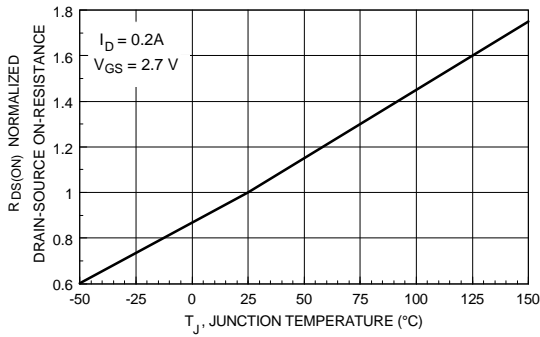

Figure 3. On-Resistance Variation with Temperature.

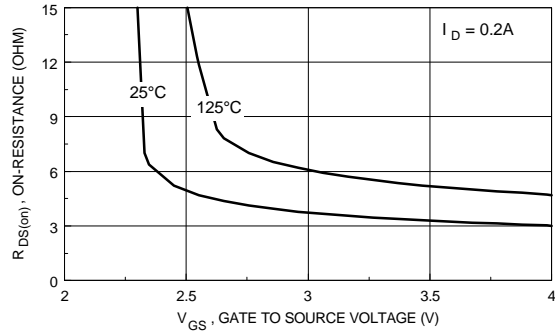

Figure 4. On Resistance Variation with Gate-To-Source Voltage.

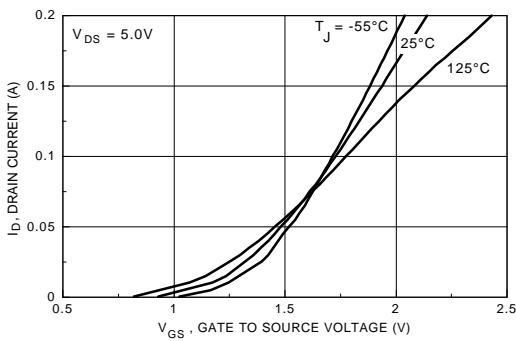

Figure 5. Transfer Characteristics.

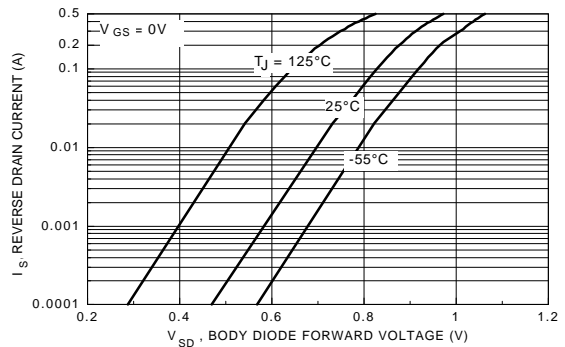

Figure 6. Body Diode Forward Voltage Variation with Source Current and Temperature.

Typical Electrical Characteristics: N-Channel (continued)

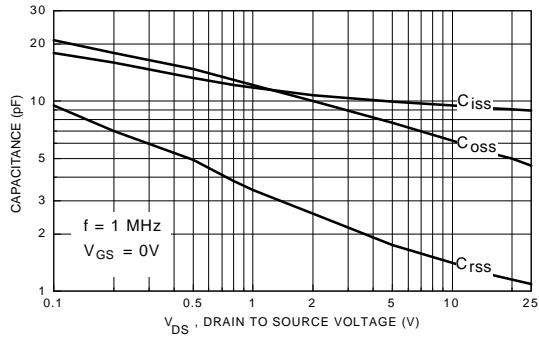

Figure 7. Capacitance Characteristics.

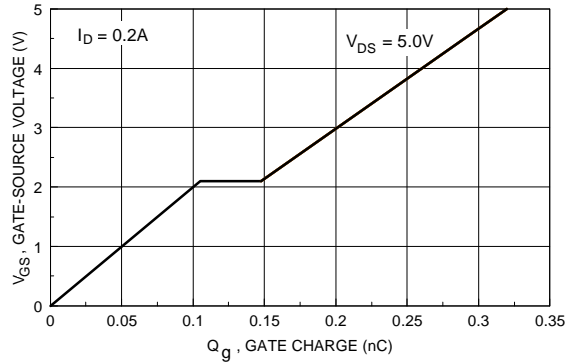

Figure 8. Gate Charge Characteristics.

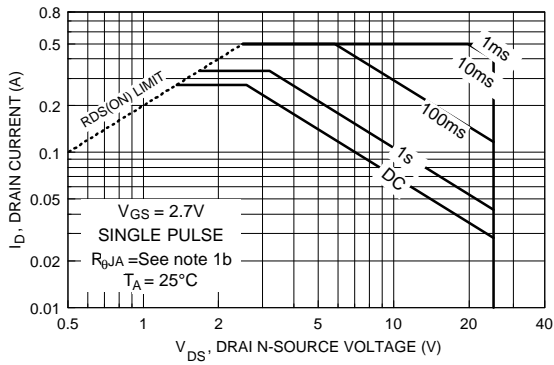

Figure 9. Maximum Safe Operating Area.

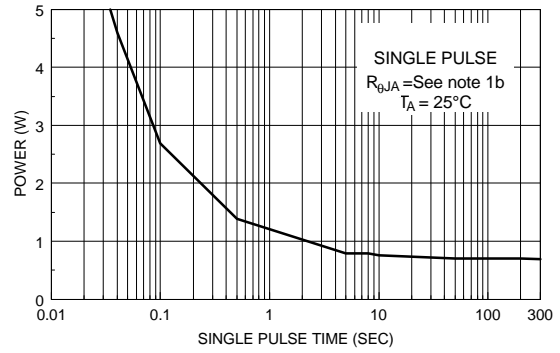

Figure 10. Single Pulse Maximum Power Dissipation.

Typical Electrical Characteristics: P-Channel

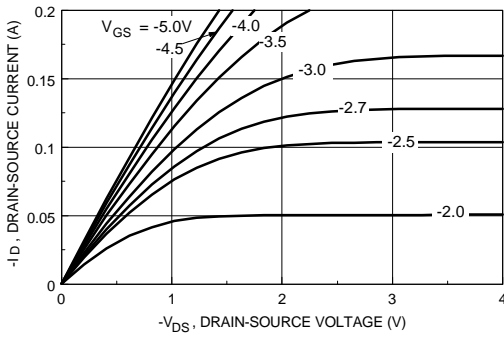

Figure 11. On-Region Characteristics.

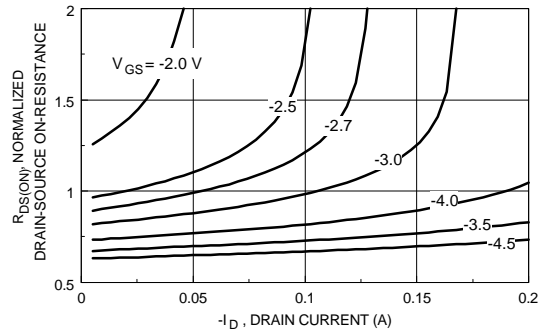

Figure 12. On-Resistance Variation with Drain Current and Gate Voltage.

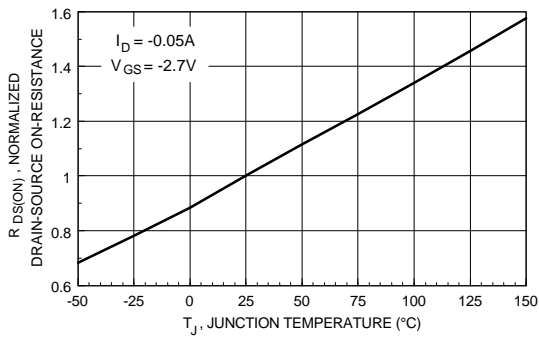

Figure 13. On-Resistance Variation with Temperature.

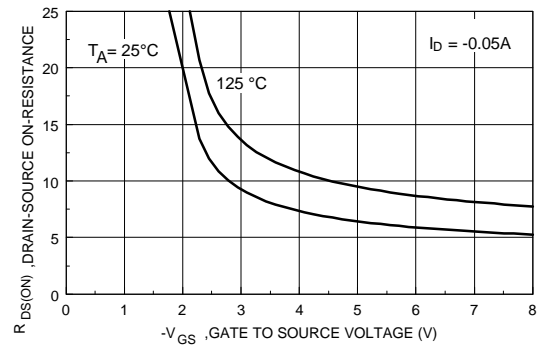

Figure 14. On Resistance Variation with Gate-To- Source Voltage.

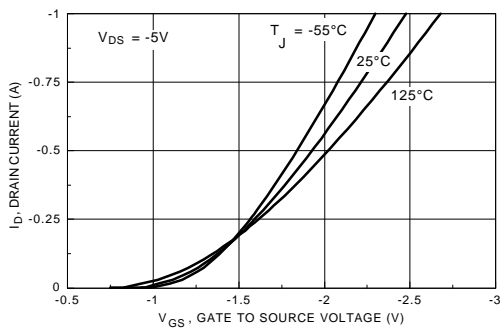

Figure 15. Transfer Characteristics.

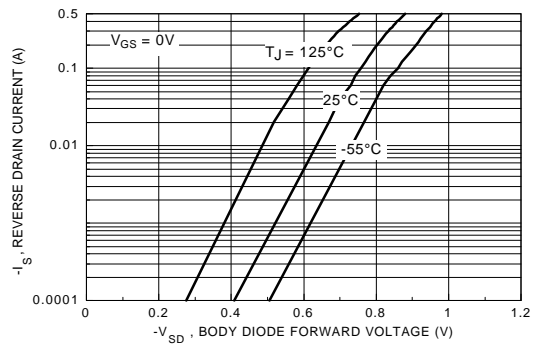

Figure 16. Body Diode Forward Voltage Variation with Source Current and Temperature.

Typical Electrical Characteristics: P-Channel (continued)

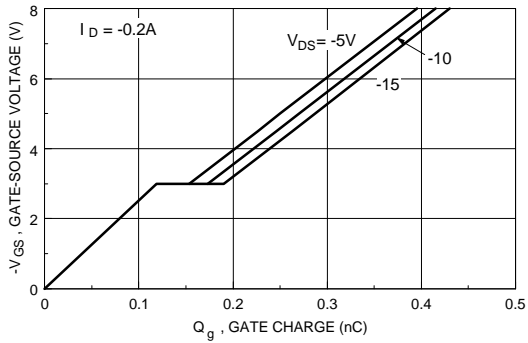

Figure 17. Gate Charge Characteristics.

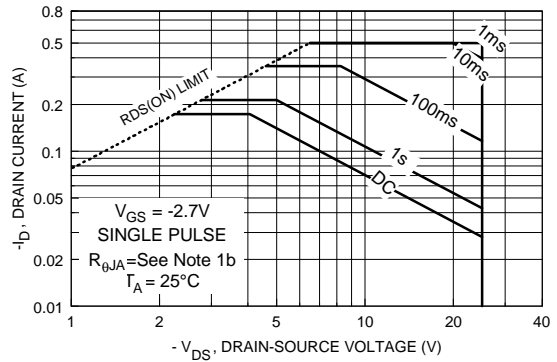

Figure 18. Maximum Safe Operating Area.

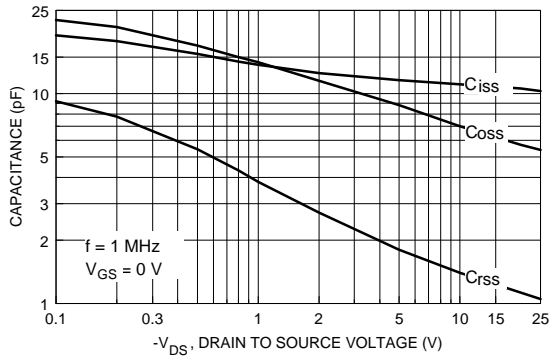

Figure 19. Capacitance Characteristics.

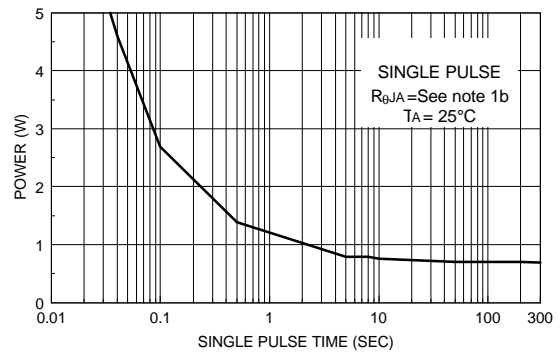

Figure 20. Single Pulse Maximum Power Dissipation.

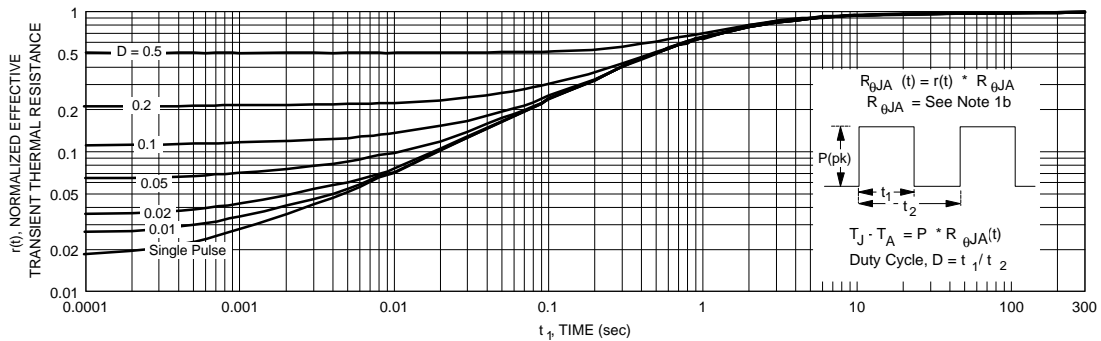

Figure 21. Transient Thermal Response Curve.

Note: Thermal characterization performed using the conditions described in note 1b. Transient thermal response will change depending on the circuit board design.

ON Semiconductor and  are trademarks of Semiconductor Components Industries, LLC dba ON Semiconductor or its subsidiaries in the United States and/or other countries. ON Semiconductor owns the rights to a number of patents, trademarks, copyrights, trade secrets, and other intellectual property. A listing of ON Semiconductor's product/patent coverage may be accessed at www.onsemi.com/site/pdf/Patent-Marking.pdf. ON Semiconductor reserves the right to make changes without further notice to any products herein. ON Semiconductor makes no warranty, representation or guarantee regarding the suitability of its products for any particular purpose, nor does ON Semiconductor assume any liability arising out of the application or use of any product or circuit, and specifically disclaims any and all liability, including without limitation special, consequential or incidental damages. Buyer is responsible for its products and applications using ON Semiconductor products, including compliance with all laws, regulations and safety requirements or standards, regardless of any support or applications information provided by ON Semiconductor. "Typical" parameters which may be provided in ON Semiconductor data sheets and/or specifications can and do vary in different applications and actual performance may vary over time. All operating parameters, including "Typicals" must be validated for each customer application by customer's technical experts. ON Semiconductor does not convey any license under its patent rights nor the rights of others. ON Semiconductor products are not designed, intended, or authorized for use as a critical component in life support systems or any FDA Class 3 medical devices or medical devices with a same or similar classification in a foreign jurisdiction or any devices intended for implantation in the human body. Should Buyer purchase or use ON Semiconductor products for any such unintended or unauthorized application, Buyer shall indemnify and hold ON Semiconductor and its officers, employees, subsidiaries, affiliates, and distributors harmless against all claims, costs, damages, and expenses, and reasonable attorney fees arising out of, directly or indirectly, any claim of personal injury or death associated with such unintended or unauthorized use, even if such claim alleges that ON Semiconductor was negligent regarding the design or manufacture of the part. ON Semiconductor is an Equal Opportunity/Affirmative Action Employer. This literature is subject to all applicable copyright laws and is not for resale in any manner.

PUBLICATION ORDERING INFORMATION

LITERATURE FULFILLMENT:

Literature Distribution Center for ON Semiconductor
19521 E. 32nd Pkwy, Aurora, Colorado 80011 USA
Phone: 303-675-2175 or 800-344-3860 Toll Free USA/Canada
Fax: 303-675-2176 or 800-344-3867 Toll Free USA/Canada
Email: orderlit@onsemi.com

N. American Technical Support: 800-282-9855 Toll Free
USA/Canada
Europe, Middle East and Africa Technical Support:
Phone: 421 33 790 2910
Japan Customer Focus Center
Phone: 81-3-5817-1050

ON Semiconductor Website: www.onsemi.com
Order Literature: <http://www.onsemi.com/orderlit>
For additional information, please contact your local
Sales Representative

Looking for pricing, stock, or lifecycle information?

Click below to explore more details on WIN SOURCE:

- ⊖ [View FDC6320C on WIN SOURCE](#)
- ⊖ [Fairchild/ON Semiconductor Information](#)

Optimize Your Supply Chain with WIN SOURCE Solutions

- ✓ Global Sourcing Solution
- ✓ Obsolete Management
- ✓ Cost Control Management
- ✓ Shortage Management
- ✓ Alternative Solution
- ✓ Excess Inventory Management