



**THE DATASHEET OF  
FDJ1028N**



# FDJ1028N

## N-Channel 2.5 Vgs Specified PowerTrench® MOSFET

### Features

- 3.2 A, 20 V.  $R_{DS(ON)} = 90\text{ m}\Omega @ V_{GS} = 4.5\text{ V}$   
 $R_{DS(ON)} = 130\text{ m}\Omega @ V_{GS} = 2.5\text{ V}$
- Low gate charge
- High performance trench technology for extremely low  $R_{DS(ON)}$
- FLMP SC75 package: Enhanced thermal performance in industry-standard package size

### Applications

- Battery management

### General Description

This dual N-Channel 2.5V specified MOSFET uses Fairchild's advanced low voltage PowerTrench process. Packaged in FLMP SC75, the  $R_{DS(ON)}$  and thermal properties of the device are optimized for battery power management applications.

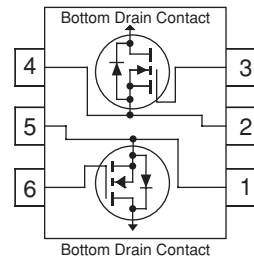
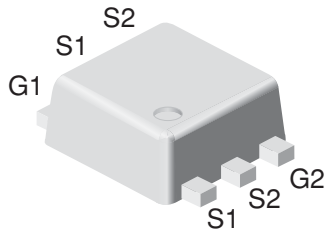

### Absolute Maximum Ratings $T_A = 25^\circ\text{C}$ unless otherwise noted

Symbol	Parameter	Ratings	Units
$V_{DSS}$	Drain-Source Voltage	20	V
$V_{GSS}$	Gate-Source Voltage	$\pm 12$	V
$I_D$	Drain Current – Continuous (Note 1a)	3.2	A
		– Pulsed	
$P_D$	Power Dissipation for single Operation (Note 1a)	1.5	W
$T_J, T_{STG}$	Operating and Storage Junction Temperature Range	$-55$ to $+150$	$^\circ\text{C}$
<b>Thermal Characteristics</b>			
$R_{\theta JA}$	Thermal Resistance, Junction-to-Ambient (Note 1a)	80	$^\circ\text{C/W}$
$R_{\theta JC}$	Thermal Resistance, Junction-to-Case	5	

### Package Marking and Ordering Information

Device Marking	Device	Reel Size	Tape width	Quantity
.F	FDJ1028N	7"	8mm	3000 units

**Electrical Characteristics**  $T_A = 25^\circ\text{C}$  unless otherwise noted

Symbol	Parameter	Test Conditions	Min	Typ	Max	Units
<b>Off Characteristics</b>						
$BV_{DSS}$	Drain-Source Breakdown Voltage	$V_{GS} = 0\text{ V}, I_D = 250\ \mu\text{A}$	20			V
$\frac{\Delta BV_{DSS}}{\Delta T_J}$	Breakdown Voltage Temperature Coefficient	$I_D = 250\ \mu\text{A}$ , Referenced to $25^\circ\text{C}$		13		$\text{mV}/^\circ\text{C}$
$I_{DSS}$	Zero Gate Voltage Drain Current	$V_{DS} = 16\text{ V}, V_{GS} = 0\text{ V}$			1	$\mu\text{A}$
$I_{GSS}$	Gate-Body Leakage	$V_{GS} = \pm 12\text{ V}, V_{DS} = 0\text{ V}$			$\pm 100$	nA
<b>On Characteristics (Note 2)</b>						
$V_{GS(th)}$	Gate Threshold Voltage	$V_{DS} = V_{GS}, I_D = 250\ \mu\text{A}$	0.6	1.0	1.5	V
$\frac{\Delta V_{GS(th)}}{\Delta T_J}$	Gate Threshold Voltage Temperature Coefficient	$I_D = 250\ \mu\text{A}$ , Referenced to $25^\circ\text{C}$		-3		$\text{mV}/^\circ\text{C}$
$R_{DS(on)}$	Static Drain-Source On-Resistance	$V_{GS} = 4.5\text{ V}, I_D = 3.2\text{ A}$ $V_{GS} = 2.5\text{ V}, I_D = 2.7\text{ A}$ $V_{GS} = 4.5\text{ V}, I_D = 3.2\text{ A}, T_J = 125^\circ\text{C}$		70 100 83	90 130 132	$\text{m}\Omega$
$g_{FS}$	Forward Transconductance	$V_{DS} = 5\text{ V}, I_D = 3.2\text{ A}$		7.5		S
<b>Dynamic Characteristics</b>						
$C_{iss}$	Input Capacitance	$V_{DS} = 10\text{ V}, V_{GS} = 0\text{ V},$ $f = 1.0\text{ MHz}$		200		pF
$C_{oss}$	Output Capacitance			50		pF
$C_{rss}$	Reverse Transfer Capacitance			30		pF
$R_G$	Gate Resistance	$f = 1.0\text{ MHz}$		3		$\Omega$
<b>Switching Characteristics (Note 2)</b>						
$t_{d(on)}$	Turn-On Delay Time	$V_{DD} = 10\text{ V}, I_D = 1\text{ A},$ $V_{GS} = 4.5\text{ V}, R_{GEN} = 6\ \Omega$		7	14	ns
$t_r$	Turn-On Rise Time			8	16	ns
$t_{d(off)}$	Turn-Off Delay Time			11	20	ns
$t_f$	Turn-Off Fall Time			2	4	ns
$Q_g$	Total Gate Charge	$V_{DS} = 10\text{ V}, I_D = 3.2\text{ A},$ $V_{GS} = 4.5\text{ V}$		2	3	nC
$Q_{gs}$	Gate-Source Charge			0.4		nC
$Q_{gd}$	Gate-Drain Charge			1.0		nC
<b>Drain-Source Diode Characteristics and Maximum Ratings</b>						
$I_S$	Maximum Continuous Drain-Source Diode Forward Current				1.25	A
$V_{SD}$	Drain-Source Diode Forward Voltage	$V_{GS} = 0\text{ V}, I_S = 1.25\text{ A}$ (Note 2)		0.8	1.2	V
$t_{rr}$	Diode Reverse Recovery Time	$I_F = 3.2\text{ A},$ $d_I/d_t = 100\text{ A}/\mu\text{s}$		11		nS
$Q_{rr}$	Diode Reverse Recovery Charge			2.5		nC

**Notes:**

- $R_{\theta JA}$  is the sum of the junction-to-case and case-to-ambient thermal resistance where the case thermal reference is defined as the solder mounting surface of the drain pins.  $R_{\theta JC}$  is guaranteed by design while  $R_{\theta CA}$  is determined by the user's board design.



a)  $80^\circ\text{C}/\text{W}$  when mounted on a  $1\text{ in}^2$  pad of 2 oz copper (Single Operation).

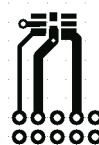

b)  $140^\circ\text{C}/\text{W}$  when mounted on a minimum pad of 2 oz copper (Single Operation).

Scale 1 : 1 on letter size paper

2. Pulse Test: Pulse Width < 300 $\mu\text{s}$ , Duty Cycle < 2.0%

### Typical Characteristics

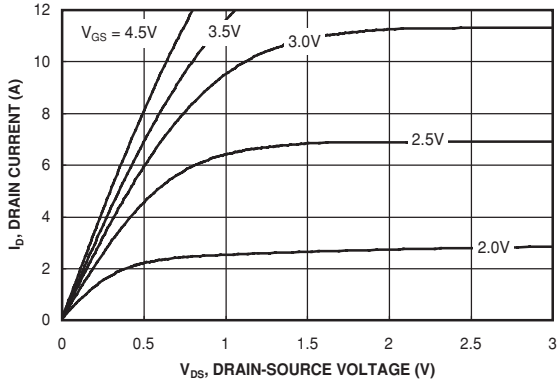

**Figure 1. On-Region Characteristics.**

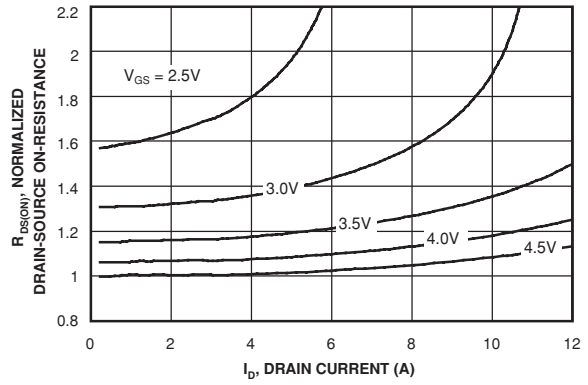

**Figure 2. On-Resistance Variation with Drain Current and Gate Voltage.**

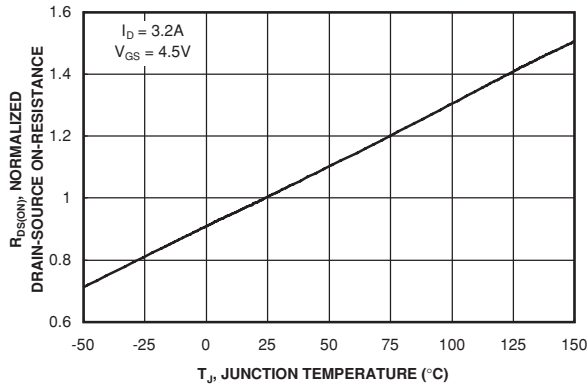

**Figure 3. On-Resistance Variation with Temperature.**

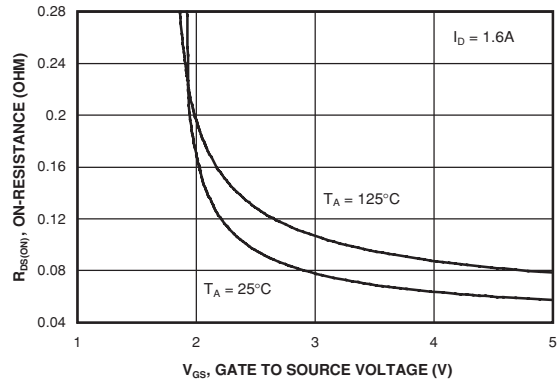

**Figure 4. On-Resistance Variation with Gate-to-Source Voltage.**

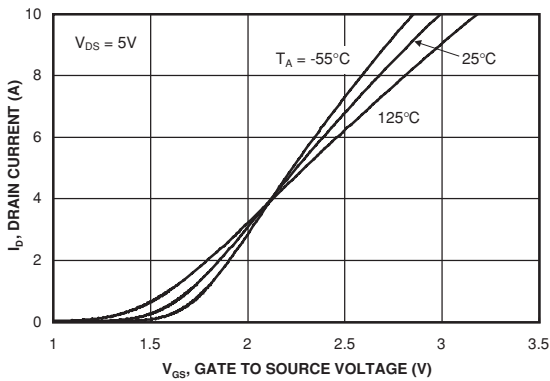

**Figure 5. Transfer Characteristics.**

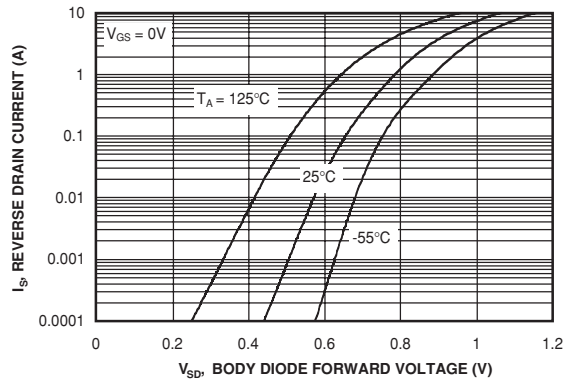

**Figure 6. Body Diode Forward Voltage Variation with Source Current and Temperature.**

### Typical Characteristics

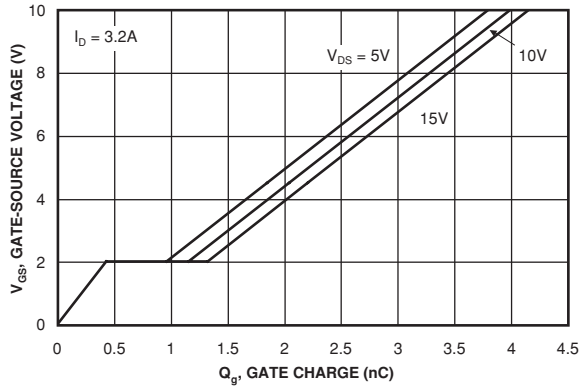

Figure 7. Gate Charge Characteristics.

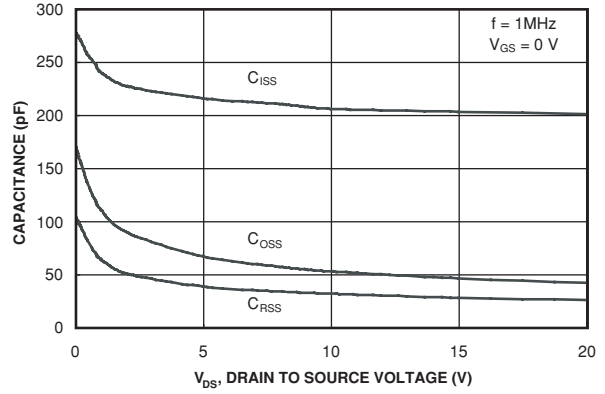

Figure 8. Capacitance Characteristics.

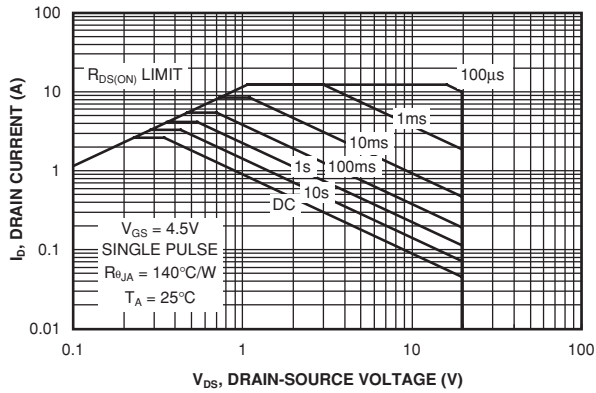

Figure 9. Maximum Safe Operating Area.

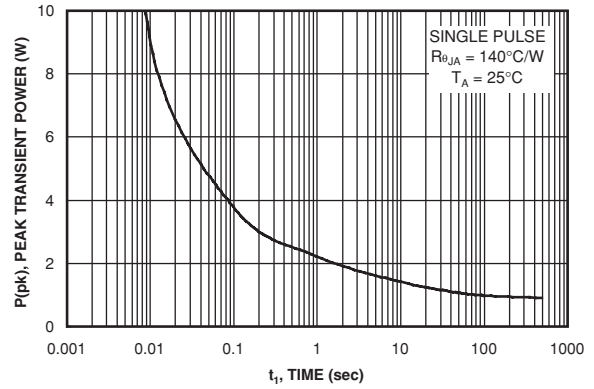

Figure 10. Single Pulse Maximum Power Dissipation.

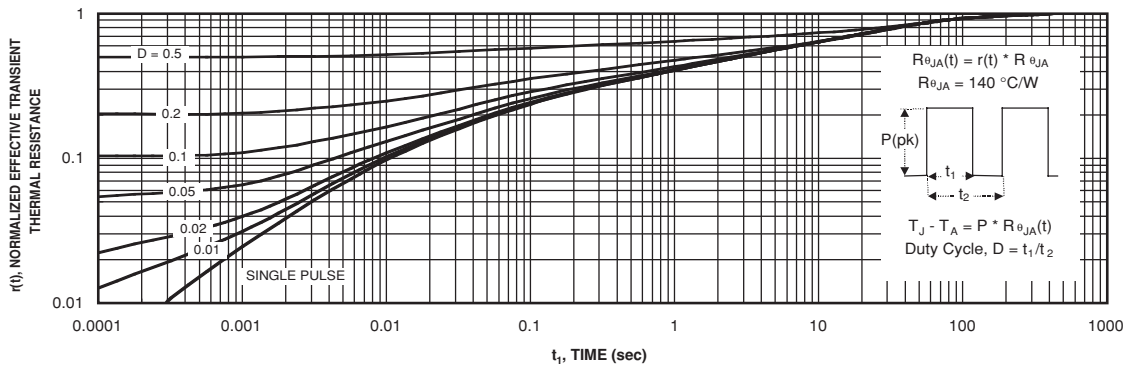
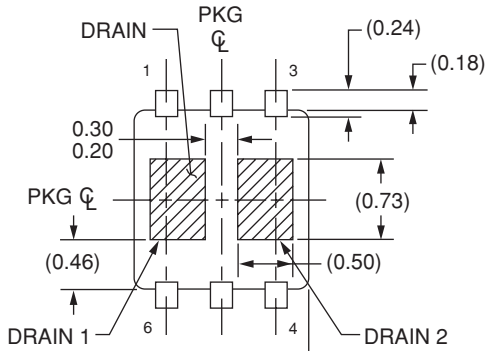

Figure 11. Transient Thermal Response Curve.

Thermal characterization performed using the conditions described in Note 1b. Transient thermal response will change depending on the circuit board design.

### Dimensional Outline and Pad Layout



**Bottom View**

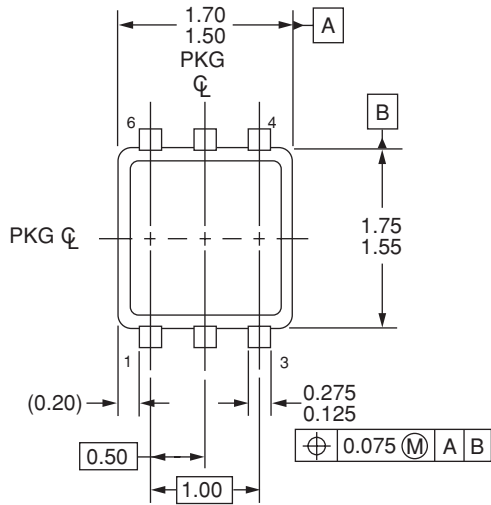

**Top View**

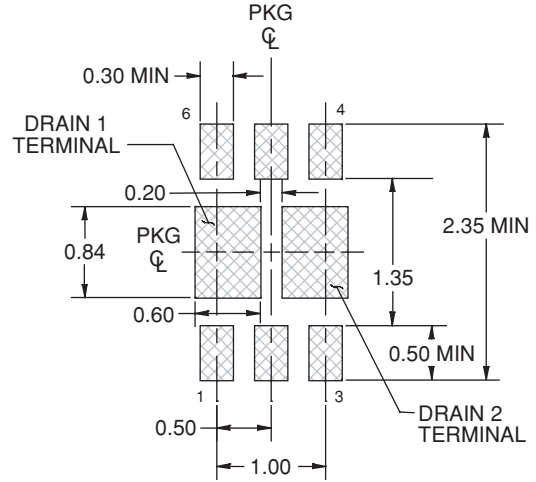
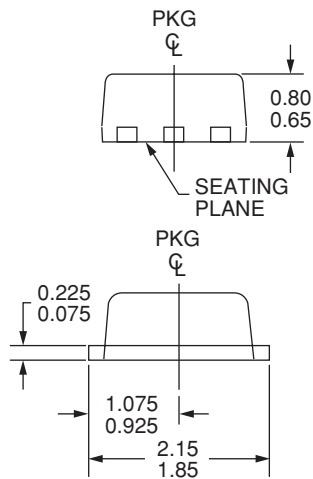

**Recommended Landing Pattern**

## TRADEMARKS

The following are registered and unregistered trademarks Fairchild Semiconductor owns or is authorized to use and is not intended to be an exhaustive list of all such trademarks.

ACE <sup>x</sup> <sup>TM</sup>	FACT Quiet Series <sup>TM</sup>	OCX <sup>TM</sup>	SILENT SWITCHER <sup>®</sup>	UniFET <sup>TM</sup>
ActiveArray <sup>TM</sup>	GlobalOptoisolator <sup>TM</sup>	OCXPro <sup>TM</sup>	SMART START <sup>TM</sup>	UltraFET <sup>®</sup>
Bottomless <sup>TM</sup>	GTO <sup>TM</sup>	OPTOLOGIC <sup>®</sup>	SPM <sup>TM</sup>	VCX <sup>TM</sup>
Build it Now <sup>TM</sup>	HiSeC <sup>TM</sup>	OPTOPLANAR <sup>TM</sup>	Stealth <sup>TM</sup>	Wire <sup>TM</sup>
CoolFET <sup>TM</sup>	I <sup>2</sup> C <sup>TM</sup>	PACMAN <sup>TM</sup>	SuperFET <sup>TM</sup>	
CROSSVOLT <sup>TM</sup>	<i>i-Lo</i> <sup>TM</sup>	POP <sup>TM</sup>	SuperSOT <sup>TM</sup> -3	
DOMET <sup>TM</sup>	ImpliedDisconnect <sup>TM</sup>	Power247 <sup>TM</sup>	SuperSOT <sup>TM</sup> -6	
EcoSPARK <sup>TM</sup>	IntelliMAX <sup>TM</sup>	PowerEdge <sup>TM</sup>	SuperSOT <sup>TM</sup> -8	
E <sup>2</sup> CMOS <sup>TM</sup>	ISOPLANAR <sup>TM</sup>	PowerSaver <sup>TM</sup>	SyncFET <sup>TM</sup>	
EnSigna <sup>TM</sup>	LittleFET <sup>TM</sup>	PowerTrench <sup>®</sup>	TCM <sup>TM</sup>	
FACT <sup>TM</sup>	MICROCOUPLER <sup>TM</sup>	QFET <sup>®</sup>	TinyBoost <sup>TM</sup>	
FAST <sup>®</sup>	MicroFET <sup>TM</sup>	QS <sup>TM</sup>	TinyBuck <sup>TM</sup>	
FAST <sub>r</sub> <sup>TM</sup>	MicroPak <sup>TM</sup>	QT Optoelectronics <sup>TM</sup>	TinyPWM <sup>TM</sup>	
FPS <sup>TM</sup>	MICROWIRE <sup>TM</sup>	Quiet Series <sup>TM</sup>	TinyPower <sup>TM</sup>	
FRFET <sup>TM</sup>	MSX <sup>TM</sup>	RapidConfigure <sup>TM</sup>	TinyLogic <sup>®</sup>	
	MSXPro <sup>TM</sup>	RapidConnect <sup>TM</sup>	TINYOPTO <sup>TM</sup>	
Across the board. Around the world. <sup>TM</sup>		μSerDes <sup>TM</sup>	TruTranslation <sup>TM</sup>	
The Power Franchise <sup>®</sup>		ScalarPump <sup>TM</sup>	UHC <sup>TM</sup>	
Programmable Active Droop <sup>TM</sup>				

## DISCLAIMER

FAIRCHILD SEMICONDUCTOR RESERVES THE RIGHT TO MAKE CHANGES WITHOUT FURTHER NOTICE TO ANY PRODUCTS HEREIN TO IMPROVE RELIABILITY, FUNCTION, OR DESIGN. FAIRCHILD DOES NOT ASSUME ANY LIABILITY ARISING OUT OF THE APPLICATION OR USE OF ANY PRODUCT OR CIRCUIT DESCRIBED HEREIN; NEITHER DOES IT CONVEY ANY LICENSE UNDER ITS PATENT RIGHTS, NOR THE RIGHTS OF OTHERS. THESE SPECIFICATIONS DO NOT EXPAND THE TERMS OF FAIRCHILD'S WORLDWIDE TERMS AND CONDITIONS, SPECIFICALLY THE WARRANTY THEREIN, WHICH COVERS THESE PRODUCTS.

## LIFE SUPPORT POLICY

FAIRCHILD'S PRODUCTS ARE NOT AUTHORIZED FOR USE AS CRITICAL COMPONENTS IN LIFE SUPPORT DEVICES OR SYSTEMS WITHOUT THE EXPRESS WRITTEN APPROVAL OF FAIRCHILD SEMICONDUCTOR CORPORATION.

As used herein:

- Life support devices or systems are devices or systems which, (a) are intended for surgical implant into the body, or (b) support or sustain life, or (c) whose failure to perform when properly used in accordance with instructions for use provided in the labeling, can be reasonably expected to result in significant injury to the user.
- A critical component is any component of a life support device or system whose failure to perform can be reasonably expected to cause the failure of the life support device or system, or to affect its safety or effectiveness.



## PRODUCT STATUS DEFINITIONS

### Definition of Terms

Datasheet Identification	Product Status	Definition
Advance Information	Formative or In Design	This datasheet contains the design specifications for product development. Specifications may change in any manner without notice.
Preliminary	First Production	This datasheet contains preliminary data, and supplementary data will be published at a later date. Fairchild Semiconductor reserves the right to make changes at any time without notice to improve design.
No Identification Needed	Full Production	This datasheet contains final specifications. Fairchild Semiconductor reserves the right to make changes at any time without notice to improve design.
Obsolete	Not In Production	This datasheet contains specifications on a product that has been discontinued by Fairchild semiconductor. The datasheet is printed for reference information only.

## Looking for pricing, stock, or lifecycle information?

Click below to explore more details on WIN SOURCE:

-  [View FDJ1028N on WIN SOURCE](#)
-  [Fairchild/ON Semiconductor Information](#)

## Optimize Your Supply Chain with WIN SOURCE Solutions

-  Global Sourcing Solution
-  Obsolete Management
-  Cost Control Management
-  Shortage Management
-  Alternative Solution
-  Excess Inventory Management