



**THE DATASHEET OF  
FMS3818KRC**



# FMS3818

## Triple Video D/A Converters

### 3 x 8 bit, 180 Ms/s

#### Features

- $\pm 2.5\%$  gain matching
- $\pm 0.5$  LSB linearity error
- Internal bandgap voltage reference
- Low glitch energy
- Single 3.3 Volt power supply

#### Applications

- PC Graphics
- Video signal conversion
  - RGB
  - YCBCR
  - Composite, Y, C

#### Description

The FMS3818 is a low-cost triple D/A converter, tailored to fit graphics and video applications where speed is critical.

CMOS-level inputs are converted to analog current outputs that can drive  $25\text{--}37.5\Omega$  loads corresponding to doubly-terminated  $50\text{--}75\Omega$  loads. A sync current following SYNC input timing is added to the IOG output. BLANK will override RGB inputs, setting IOG, IOB and IOR currents to zero when BLANK = L. Although appropriate for many applications the internal 1.25V reference voltage can be overridden by the VREF input.

Few external components are required, just the current reference resistor, current output load resistors, bypass capacitors and decoupling capacitors.

Package is a 48-lead LQFP. Fabrication technology is CMOS. Performance is guaranteed from 0 to 70°C.

#### Block Diagram

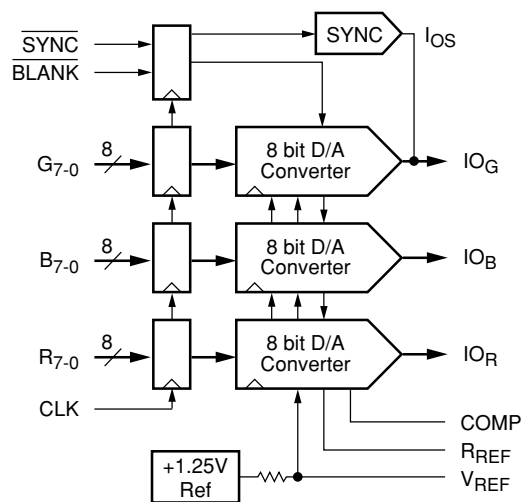

## Functional Description

Within the FMS3818 are three identical 8-bit D/A converters, each with a current source output. External loads are required to convert these currents to voltage outputs. Data inputs RGB7-0 are overridden by the  $\overline{\text{BLANK}}$  input.  $\overline{\text{SYNC}} = \text{H}$  activates sync current from  $\text{IOS}$  for sync-on-green video signals.

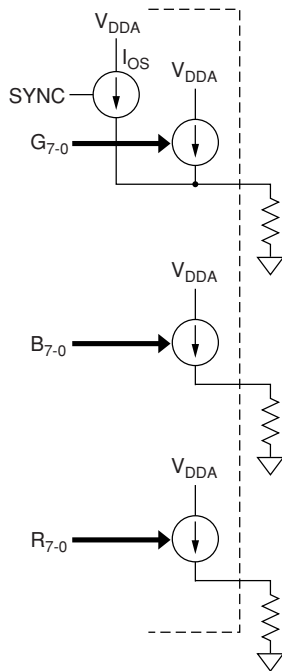

Figure 1. FMS3818 Current Source Structure

### Digital Inputs

Incoming GBR data is registered on the rising edge of the clock input, CLK. Analog outputs follow the rising edge of CLK after a delay,  $t_{\text{DO}}$ .

### $\overline{\text{SYNC}}$ and $\overline{\text{BLANK}}$

$\overline{\text{SYNC}}$  and  $\overline{\text{BLANK}}$  inputs control the output level (Figure 1 and Table 1) of the D/A converters during CRT retrace intervals.  $\overline{\text{BLANK}}$  forces the D/A outputs to the blanking level while  $\overline{\text{SYNC}} = \text{L}$  turns off a current source,  $\text{IOS}$  that is connected to the green D/A converter.  $\overline{\text{SYNC}} = \text{H}$  adds a  $112/256$  fraction of full-scale current to the green output.  $\overline{\text{SYNC}} = \text{L}$  extinguishes the sync current during the sync tip.

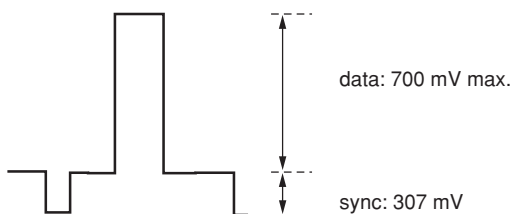

Figure 2. Nominal Output Levels

$\overline{\text{BLANK}}$  gates the D/A inputs. If  $\overline{\text{BLANK}} = \text{H}$ , the D/A inputs control the output currents to be added to the output blanking level. If  $\overline{\text{BLANK}} = \text{L}$ , data inputs and the pedestal are disabled.

### D/A Outputs

Each D/A output is a current source from the  $\text{VDDA}$  supply. Expressed in current units, the GBR transformation from data to current is as follows:

$$G = G_{7-0} \& \overline{\text{BLANK}} + \overline{\text{SYNC}} * 112$$

$$B = B_{7-0} \& \overline{\text{BLANK}}$$

$$R = R_{7-0} \& \overline{\text{BLANK}}$$

Typical LSB current step is  $73.2 \mu\text{A}$ .

To obtain a voltage output, a resistor must be connected to ground. Output voltage depends upon this external resistor, the reference voltage, and the value of the gain-setting resistor connected between  $\text{RREF}$  and  $\text{GND}$ .

To implement a doubly-terminated  $75\Omega$  transmission line, a shunt  $75\Omega$  resistor should be placed adjacent to the analog output pin. With a terminated  $75\Omega$  line connected to the analog output, the load on the FMS3818 current source is  $37.5\Omega$ .

The FMS3818 may also be operated with a single  $75 \text{ Ohm}$  terminating resistor. To lower the output voltage swing to the desired range, the nominal value of the  $\text{RREF}$  resistor should be doubled.

### Voltage Reference

Full scale current is a multiple of the current  $\text{ISET}$  through an external resistor,  $\text{RSET}$  connected between the  $\text{RREF}$  pin and  $\text{GND}$ . Voltage across  $\text{RSET}$  is the reference voltage,  $\text{VREF}$ , which can be derived from either the  $1.25$  volt internal bandgap reference or an external voltage reference connected to  $\text{VREF}$ . To minimize noise, a  $0.1\mu\text{F}$  capacitor should be connected between  $\text{VREF}$  and ground.

$\text{ISET}$  is mirrored to each of the GBR output current sources. To minimize noise, a  $0.1\mu\text{F}$  capacitor should be connected between the  $\text{COMP}$  pin and the analog supply voltage  $\text{VDDA}$ .

### Power and Ground

Required power is a single  $+3.3$  Volt supply. To minimize power supply induced noise, analog  $+3.3\text{V}$  should be connected to  $\text{VDD}$  and  $\text{VDDA}$  pins with  $0.1$  and  $0.01 \mu\text{F}$  decoupling capacitors placed adjacent to each  $\text{VDD}$  pin or pin pair.

High slew-rate digital data makes capacitive coupling to the outputs of any D/A converter a potential problem. Since the digital signals contain high-frequency components of the CLK signal, as well as the video output signal, the resulting data feedthrough often looks like harmonic distortion or reduced signal-to-noise performance. All ground pins should be connected to a common solid ground plane for best performance.

**Table 1. Output Voltage Coding**

VREF = 1.25 V, RREF = 348 Ω, RL = 37.5 Ω

| RGB7-0 (MSB...LSB) | SYNC | BLANK | VRED, VBLUE (mV) | VGREEN (mV) |
|--------------------|------|-------|------------------|-------------|
| 1111 1111          | 1    | 1     | 700              | 1,007       |
| 1111 1111          | 0    | 1     | 700              | 700         |
| 1111 1110          | 1    | 1     | 697              | 1,004       |
| 1111 1101          | 1    | 1     | 695              | 1,001       |
| ⋮                  | ⋮    | ⋮     | ⋮                | ⋮           |
| 1000 0000          | 1    | 1     | 351              | 658         |
| 0111 1111          | 1    | 1     | 349              | 656         |
| 0111 1111          | 0    | 1     | 349              | 349         |
| ⋮                  | ⋮    | ⋮     | ⋮                | ⋮           |
| 0000 0010          | 1    | 1     | 5                | 312         |
| 0000 0001          | 1    | 1     | 3                | 310         |
| 0000 0000          | 1    | 1     | 0                | 307         |
| 0000 0000          | 0    | 1     | 0                | 0           |
| XXXX XXXX          | 1    | 0     | 0                | 307         |
| XXXX XXXX          | 0    | 0     | 0                | 0           |

### Pin Assignments

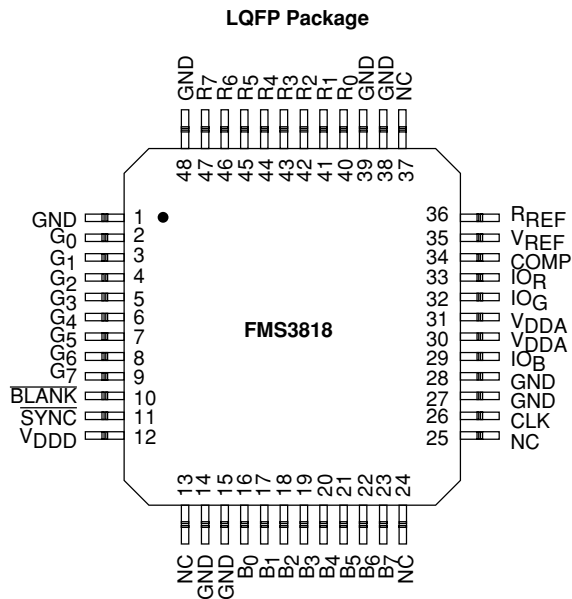

## Pin Descriptions

| Pin Name                     | Pin Number            | Value                  | Pin Function Description  |
|------------------------------|-----------------------|------------------------|---|
| <b>Clock and Data Inputs</b> |                       |                        |   |
| CLK                          | 26                    | CMOS                   | <b>Clock Input.</b> Pixel data is registered on the rising edge of CLK. CLK should be driven by a dedicated buffer to avoid reflection induced jitter, overshoot, and undershoot.   |
| R7-0<br>G7-0<br>B7-0         | 47-40<br>9-2<br>23-16 | CMOS                   | <b>Red, Green, and Blue Pixel Data Inputs.</b> RGB digital inputs are registered on the rising edge of CLK.   |
| <b>Controls</b>              |                       |                        |   |
| $\overline{\text{SYNC}}$     | 11                    | CMOS                   | <b>Sync Pulse Input.</b> Bringing $\overline{\text{SYNC}}$ LOW, disables a current source which superimposes a sync pulse on the LOG output. $\overline{\text{SYNC}}$ and pixel data are registered on the rising edge of CLK. $\overline{\text{SYNC}}$ does not override any other data and should be used only during the blanking interval. If sync pulses are not required, $\overline{\text{SYNC}}$ should be connected to GND.  |
| $\overline{\text{BLANK}}$    | 10                    | CMOS                   | <b>Blanking Input.</b> When $\overline{\text{BLANK}}$ is LOW, pixel data inputs are ignored and the D/A converter outputs are driven to the blanking level. $\overline{\text{BLANK}}$ is registered on the rising edge of CLK.  |
| <b>Video Outputs</b>         |                       |                        |   |
| IOR<br>LOG<br>IOB            | 33<br>32<br>29        | 0.700 V <sub>p-p</sub> | <b>Red, Green, and Blue Current Outputs.</b> Current source outputs can drive VESA VSIS, and RS-343A/SMPTE-170M compatible levels into doubly-terminated 75 Ohm lines. Sync pulses can be added to the green output. When $\overline{\text{SYNC}}$ is HIGH, the current added to LOG is:<br><br>$\text{IOS} = 2.33 (\text{VREF} / \text{RREF})$   |
| <b>Voltage Reference</b>     |                       |                        |   |
| VREF                         | 35                    | +1.25 V                | <b>Voltage Reference Input/Output.</b> Internal 1.25V voltage reference is available on this pin. An external +1.25 Volt reference may be applied to this pin to override the internal reference. Decoupling VREF to GND with a 0.1µF ceramic capacitor is required.  |
| RREF                         | 36                    | 348 Ω                  | <b>Current-set Resistor Node.</b> Full-scale output current of each D/A converter is determined by the value of the resistor connected between RREF and GND. Nominal value of RREF is found from:<br><br>$\text{RREF} = 5.31 (\text{VREF}/\text{IFS})$<br><br>where IFS is the full-scale output current (amps) from the D/A converter (without sync). Sync is 0.439 IFS.<br><br>D/A full-scale current may also be calculated from:<br><br>$\text{IFS} = \text{VFS}/\text{RL}$<br><br>Where VFS is the full-scale voltage level and RL is the total resistive load (ohms) on each D/A converter. |
| COMP                         | 34                    | 0.1 µF                 | <b>Compensation Capacitor Node.</b> A 0.1 µF ceramic capacitor must be connected between COMP and VDD to stabilize internal bias circuitry.   |

**Pin Descriptions** (continued)

| <b>Pin Name</b>      | <b>Pin Number</b>                | <b>Value</b> | <b>Pin Function Description</b> |
|----------------------|----------------------------------|--------------|---------------------------------|
| <b>Power, Ground</b> |                                  |              |                                 |
| VDDA                 | 30, 31                           | +3.3V        | <b>Analog Supply Voltage.</b>   |
| VDDD                 | 12                               | +3.3V        | <b>Digital Supply Voltage.</b>  |
| GND                  | 1, 14, 15, 27,<br>28, 38, 39, 48 | 0.0V         | <b>Ground.</b>                  |
| NC                   | 13, 24, 25, 37                   | —            | <b>No Connect</b>               |

## Absolute Maximum Ratings (beyond which the device may be damaged)<sup>1</sup>

| Parameter  | Min   | Typ | Max        | Unit |
|--|-------|-----|------------|------|
| <b>Power Supply Voltage</b>                                    |       |     |            |      |
| VDDA (Measured to GND)   | -0.5  |     | 4          | V    |
| VDDD (Measured to GND)   | -0.5  |     | 4          | V    |
| <b>Digital Inputs</b>  |       |     |            |      |
| Applied Voltage (Measured to GND) <sup>2</sup>                 | -0.5  |     | VDDD + 0.5 | V    |
| Forced Current <sup>3,4</sup>                                  | -5.0  |     | 5.0        | mA   |
| <b>Analog Inputs</b>   |       |     |            |      |
| Applied Voltage (Measured to GND) <sup>2</sup>                 | -0.5  |     | VDDA + 0.5 | V    |
| Forced Current <sup>3,4</sup>                                  | -10.0 |     | 10.0       | mA   |
| <b>Analog Outputs</b>  |       |     |            |      |
| Applied Voltage (Measured to GND) <sup>2</sup>                 | -0.5  |     | VDDA + 0.5 | V    |
| Forced Current <sup>3,4</sup>                                  | -60.0 |     | 60.0       | mA   |
| Short Circuit Duration (single output in HIGH state to ground) |       |     | unlimited  | sec. |
| <b>Temperature</b>   |       |     |            |      |
| Operating, Ambient   | -20   |     | 110        | °C   |
| Junction   |       |     | 150        | °C   |
| Lead Soldering (10 seconds)                                    |       |     | 300        | °C   |
| Vapor Phase Soldering (1 minute)                               |       |     | 220        | °C   |
| Storage  | -65   |     | 150        | °C   |

### Notes:

1. Functional operation under any of these conditions is NOT implied. Performance and reliability are guaranteed only if Operating Conditions are not exceeded.
2. Applied voltage must be current limited to specified range.
3. Forcing voltage must be limited to specified range.
4. Current is specified as conventional current flowing into the device.

## Operating Conditions

| Parameter | Min                            | Nom | Max | Units |     |    |
|-----------|--------------------------------|-----|-----|-------|-----|----|
| VDD       | Power Supply Voltage           |     | 3.0 | 3.3   | 3.6 | V  |
| VREF      | Reference Voltage, External    |     | 1.0 | 1.25  | 1.5 | V  |
| CC        | Compensation Capacitor         |     |     | 0.1   |     | μF |
| RL        | Output Load                    |     |     | 37.5  |     | Ω  |
| TA        | Ambient Temperature, Still Air |     | 0   |       | 70  | °C |

## Test Rank Definitions

| Rank |  |
|------|--|
| P    | Production tested at 25°C.   |
| D    | Guaranteed by design over full temperature range.                      |
| C    | Guaranteed by characterization and design over full temperature range. |
| T    | Target specification, pending characterization.                        |

## Electrical Characteristics<sup>1</sup>

| Parameter                    |                         |         | Temp | Test Rank | Min   | Typ  | Max   | Unit   |
|------------------------------|-------------------------|---------|------|-----------|-------|------|-------|--------|
| <b>Power Supply Currents</b> |                         |         |      |           |       |      |       |        |
| I <sub>DD</sub>              | Supply Current          | FMS3818 | 25°C | P         |       | 80   |       | mA     |
|                              |                         | FMS3818 | Full | C         |       |      | 90    |        |
|                              | Power Dissipation       |         | Full | D         |       |      | 300   | mW     |
| <b>Digital Inputs</b>        |                         |         |      |           |       |      |       |        |
| V <sub>IH</sub>              | Input Voltage, HIGH     |         | Full | PC        | 2.5   |      |       | V      |
| V <sub>IL</sub>              | Input Voltage, LOW      |         | Full | PC        |       |      | 0.8   | V      |
| I <sub>IH</sub>              | Input Current, HIGH     |         | Full | PC        | -1    |      | +1    | μA     |
| I <sub>IL</sub>              | Input Current, LOW      |         | Full | PC        | -1    |      | +1    | μA     |
| C <sub>I</sub>               | Input Capacitance       |         | 25°C | D         |       | 4    |       | pF     |
| <b>Analog Outputs</b>        |                         |         |      |           |       |      |       |        |
|                              | Output Current          |         | 25°C | PC        |       |      | 30    | mA     |
| R <sub>O</sub>               | Output Resistance       |         | 25°C | C         |       | 40   |       | kΩ     |
| C <sub>O</sub>               | Output Capacitance      |         | 25°C | D         |       | 7    |       | pF     |
| <b>Reference Output</b>      |                         |         |      |           |       |      |       |        |
| V <sub>REF</sub>             | Output Voltage          |         | Full | PC        | 1.135 | 1.25 | 1.365 | V      |
|                              | Temperature Coefficient |         | Full | CT        |       |      |       | ppm/°C |

**Note:**

- Specified under normal operation conditions: V<sub>DDA</sub> = V<sub>DDD</sub> = 3.3V with external 1.25V reference.

## Switching Characteristics<sup>1</sup>

| Parameter                       |                       |         | Temp | Test Rank | Min | Typ | Max | Unit |
|---------------------------------|-----------------------|---------|------|-----------|-----|-----|-----|------|
| <b>Clock Input</b>              |                       |         |      |           |     |     |     |      |
|                                 | Conversion rate       | FMS3818 | Full | C         |     |     | 180 | Ms/s |
| t <sub>PWH</sub>                | Pulse-width HIGH      |         | Full | C         | 2   |     |     | ns   |
| t <sub>PWL</sub>                | Pulse-width LOW       |         | Full | C         | 2   |     |     | ns   |
| <b>Data Inputs</b>              |                       |         |      |           |     |     |     |      |
| t <sub>S</sub>                  | Setup                 | FMS3818 | 25°C | P         | 1.5 |     |     | ns   |
|                                 |                       | FMS3818 | Full | C         | 2   |     |     | ns   |
| t <sub>H</sub>                  | Hold                  | FMS3818 | 25°C | P         |     |     | 0.6 | ns   |
|                                 |                       | FMS3818 | Full | C         |     |     | 0.6 | ns   |
| <b>Data Outputs<sup>2</sup></b> |                       |         |      |           |     |     |     |      |
| t <sub>D</sub>                  | Clock to Output Delay |         | Full | C         |     | 1.6 |     | ns   |
| t <sub>R</sub>                  | Rise Time             |         | Full | C         |     | 0.6 |     | ns   |
| t <sub>F</sub>                  | Fall Time             |         | Full | C         |     | 0.4 |     | ns   |
| t <sub>SET</sub>                | Settling Time         |         |      | C         |     | 2.5 |     | ns   |
| t <sub>SKEW</sub>               | Skew                  |         |      | C         |     | 0.3 |     | ns   |

**Notes:**

- Specified under normal operation conditions: V<sub>DDA</sub> = V<sub>DDD</sub> = 3.3V with external 1.25V reference.
- With 50Ω doubly terminated load with internal 1.25V reference.

## DC Performance<sup>1</sup>

| Parameter      |  | Temp | Test Rank | Min   | Typ <sup>1</sup> | Max   | Unit |
|----------------|--|------|-----------|-------|------------------|-------|------|
|                | Resolution                             | Full | D         | 8     |                  |       | bits |
| DNL            | Differential Non-Linearity Error       | 25°C | P         | -0.5  |                  | +0.5  | LSB  |
|                |  | Full | C         | -0.5  |                  | +0.5  |      |
| INL            | Integral Non-Linearity Error           | 25°C | P         | -0.5  |                  | +0.5  | LSB  |
|                |  | Full | C         | -0.5  |                  | +0.5  |      |
|                | Offset Error                           | Full | PC        |       |                  | 0.01  | %FS  |
|                | Gain Matching Error                    | Full | PC        | -2.5  |                  | +2.5  | %FS  |
|                | Absolute Gain Error <sup>1</sup>       | Full | PC        | -3.5  |                  | +3.5  | %FS  |
|                | Full-scale Output Current <sup>1</sup> | Full | C         | 18.0  | 18.7             | 19.4  | mA   |
|                |  | 25°C | P         |       |                  |       |      |
|                | Full-scale Output Current <sup>2</sup> | Full | PC        |       | 18.7             |       | mA   |
| PSRR           | Power Supply Rejection Ratio (DC)      | Full | C         | -0.01 | 0                | +0.01 | %/%  |
| <b>Thermal</b> |  |      |           |       |                  |       |      |
| $\theta_{JC}$  | Resistance, Junction-to-Case           |      |           |       |                  |       | °C/W |
| $\theta_{JA}$  | Resistance, Junction-to-Ambient        |      | D         |       | 91               |       | °C/W |

### Notes:

- Specified under normal operation conditions:  $V_{DDA} = V_{DDD} = 3.3V$  with external 1.25V reference.  $R_{REF} = 348\Omega$ .
- With internal reference. Trim RSET to calibrate full-scale current.

## AC Performance<sup>1</sup>

| Parameter             | Temp | Test Rank | Min | Typ <sup>1</sup> | Max | Unit  |
|-----------------------|------|-----------|-----|------------------|-----|-------|
| <b>Analog Outputs</b> |      |           |     |                  |     |       |
| Glitch Energy         | 7    | C         |     | 20               |     | pVsec |
| DAC-to-DAC Crosstalk  | 25°C | C         |     | 30               |     | dB    |
| Data Feedthrough      | 25°C | C         |     | 50               |     | dB    |
| Clock Feedthrough     | 25°C | C         |     | 60               |     | dB    |

### Note:

- Specified under normal operation conditions:  $V_{DDA} = V_{DDD} = 3.3V$  with external 1.25V reference.

## Timing Diagram

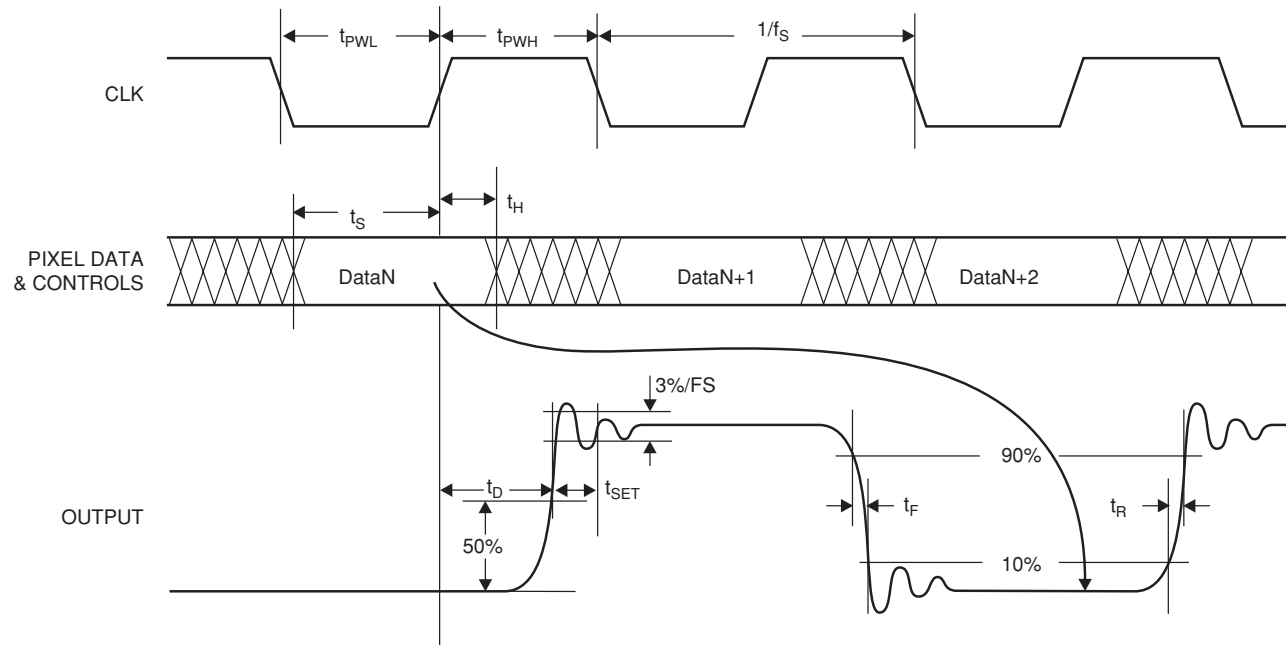

## Applications Information

Figure 4 illustrates a typical FMS3818 interface circuit. In this example, an optional 1.2 Volt bandgap reference is connected to the VREF output, overriding the internal voltage reference source.

### Grounding

It is important that the FMS3818 power supply is well-regulated and free of high-frequency noise. Careful power supply decoupling will ensure the highest quality video signals at the output of the circuit. The FMS3818 has separate analog and digital circuits. To keep digital system noise away from the D/A converter, it is recommended that power supply voltages come from the system analog power source and all ground connections (GND) be made to the analog ground plane. Power supply pins should be individually decoupled at the pin.

### Printed Circuit Board Layout

Designing with high-performance mixed-signal circuits demands printed circuits with ground planes. Overall system performance is strongly influenced by the board layout. Capacitive coupling from digital to analog circuits may result in poor D/A conversion. Consider the following suggestions when doing the layout:

1. Keep the critical analog traces (VREF, IREF, COMP, IOS, IOR, IOG) as short as possible and as far as possible from all digital signals. The FMS3818 should be located near the board edge, close to the analog output connectors.
2. The power plane for the FMS3818 should be separate from that which supplies the digital circuitry. A single power plane should be used for all of the VDD pins. If the power supply for the FMS3818 is the same as that of the system's digital circuitry, power to the FMS3818 should be decoupled with 0.1 $\mu$ F and 0.01 $\mu$ F capacitors and isolated with a ferrite bead.
3. The ground plane should be solid, not cross-hatched. Connections to the ground plane should have very short leads.
4. If the digital power supply has a dedicated power plane layer, it should not be placed under the FMS3818, the voltage reference, or the analog outputs. Capacitive coupling of digital power supply noise from this layer to the FMS3818 and its related analog circuitry can have an adverse effect on performance.
5. CLK should be handled carefully. Jitter and noise on this clock will degrade performance. Terminate the clock line carefully to eliminate overshoot and ringing.

### Improved Transition Times

Output shunt capacitance dominates slowing of output transition times, whereas series inductance causes a small amount of ringing that affects overshoot and settling time. With a doubly terminated 75 $\Omega$  load, transition times can be improved by matching the capacitive impedance output of the FMS3818. Output capacitance can be matched with a 220 nH inductor in series with the 75 $\Omega$  source termination.

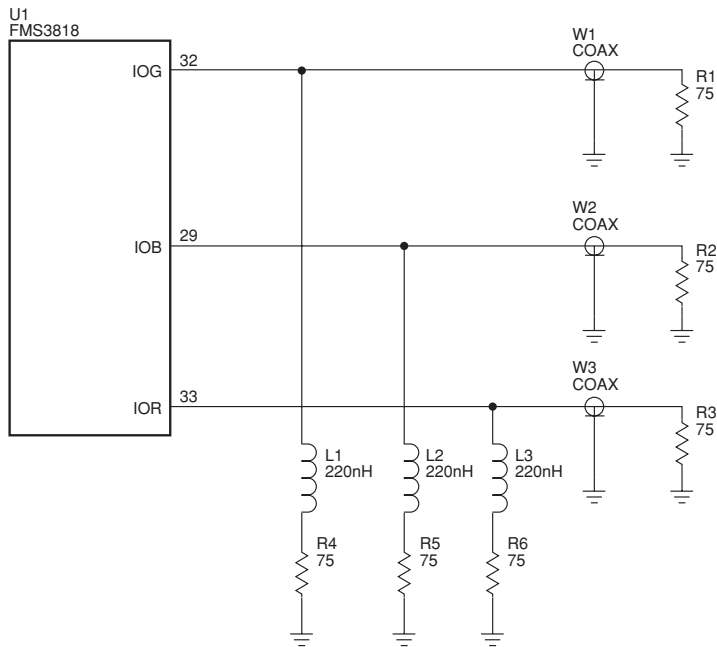

Figure 3. Schematic, FMS3818 Transition Time Sharpening Circuit

A 220 nH inductor trims the performance of a 4 ft cable, quite well. In Figures 4 through 7, the glitch at 12.5 ns, is due to a reflection from the source. Not shown, are smaller

glitches at 25 and 37.5 ns, corresponding to secondary and tertiary reflections. Inductor values should be selected to match the length and type of the cable.

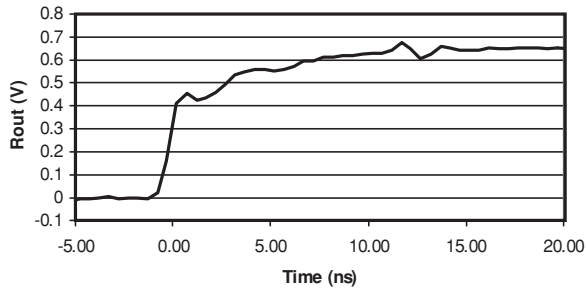

Figure 4. Unmatched tr.

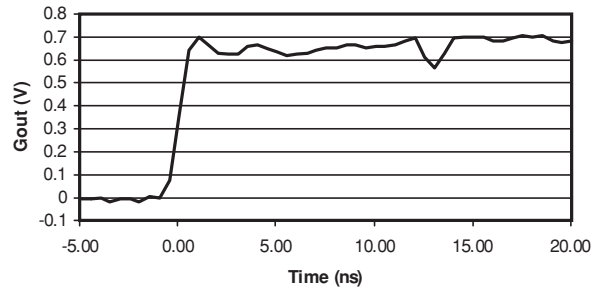

Figure 5. Matched tr.

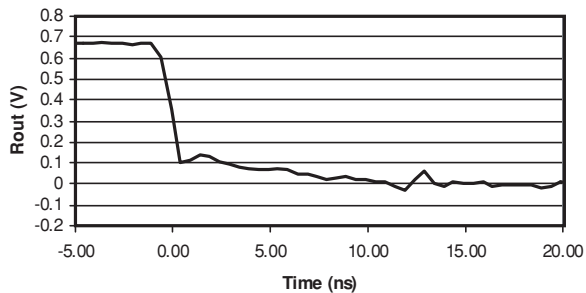

Figure 6. Unmatched tf.

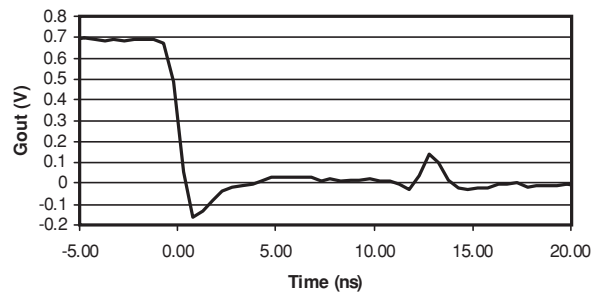

Figure 7. Matched tf.

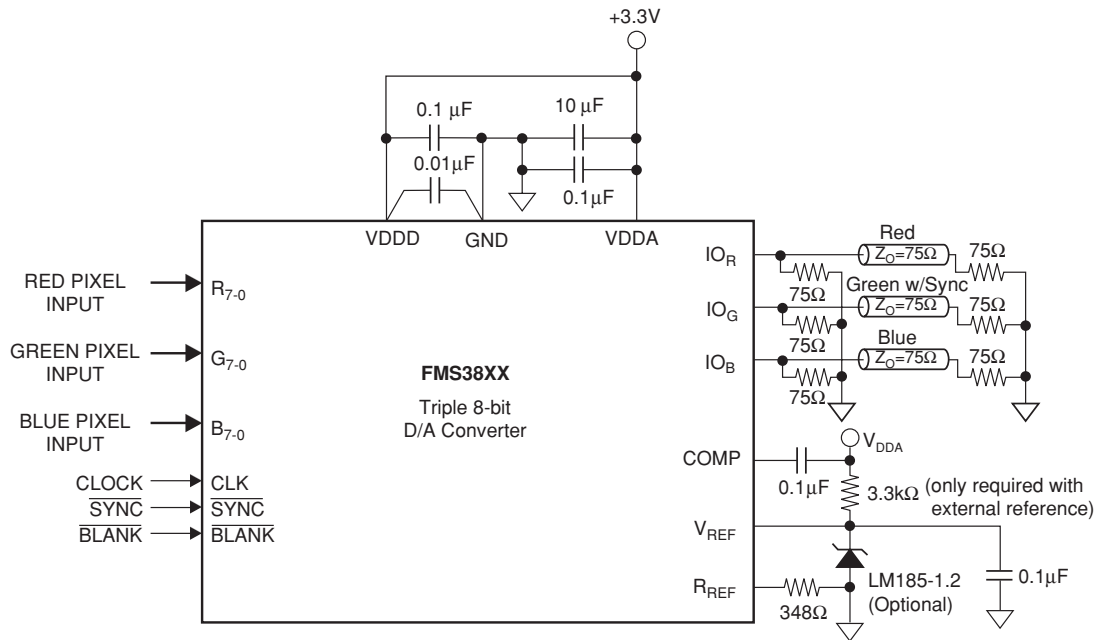

Figure 8. Typical Interface Circuit

### Related Products

- FMS3110/3115 Triple 10-bit 150 Msp/s D/A Converters
- FMS9884A 3 x 8 bit 140 Ms/s A/D Converter

# Mechanical Dimensions

## 48-Lead LQFP Package

| Symbol   | Inches   |      | Millimeters |      | Notes |
|----------|----------|------|-------------|------|-------|
|          | Min.     | Max. | Min.        | Max. |       |
| A        | .055     | .063 | 1.40        | 1.60 |       |
| A1       | .001     | .005 | .05         | .15  |       |
| A2       | .053     | .057 | 1.35        | 1.45 |       |
| B        | .006     | .010 | .17         | .27  | 7     |
| D/E      | .346     | .362 | 8.8         | 9.2  |       |
| D1/E1    | .268     | .284 | 6.8         | 7.2  | 2     |
| e        | .019 BSC |      | .50 BSC     |      |       |
| L        | .017     | .029 | .45         | .75  | 6     |
| N        | 48       |      | 48          |      | 4     |
| ND       | 12       |      | 12          |      | 5     |
| $\alpha$ | 0°       | 7°   | 0°          | 7°   |       |
| ccc      | .004     |      | 0.08        |      |       |

**Notes:**

1. All dimensions and tolerances conform to ANSI Y14.5M-1982.
2. Dimensions "D1" and "E1" do not include mold protrusion. Allowable protrusion is 0.25mm per side. D1 and E1 are maximum plastic body size dimensions including mold mismatch.
3. Pin 1 identifier is optional.
4. Dimension N: Number of terminals.
5. Dimension ND: Number of terminals per package edge.
6. "L" is the length of terminal for soldering to a substrate.
7. Dimension "B" does not include dambar protrusion. Allowable dambar protrusion shall not cause the lead width to exceed the maximum B dimension by more than 0.08mm. Dambar can not be located on the lower radius or the foot. Minimum space between protrusion and an adjacent lead is 0.07mm.

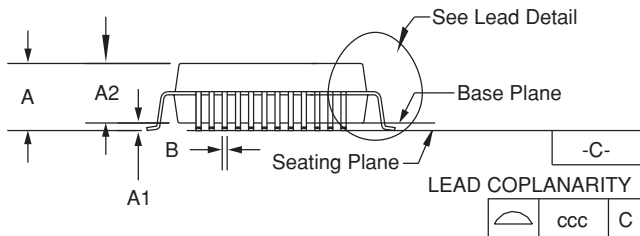
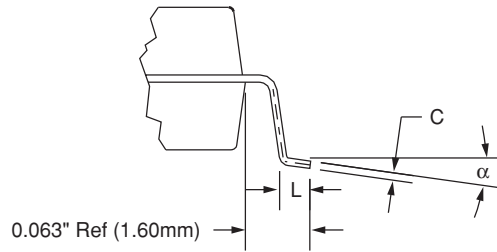
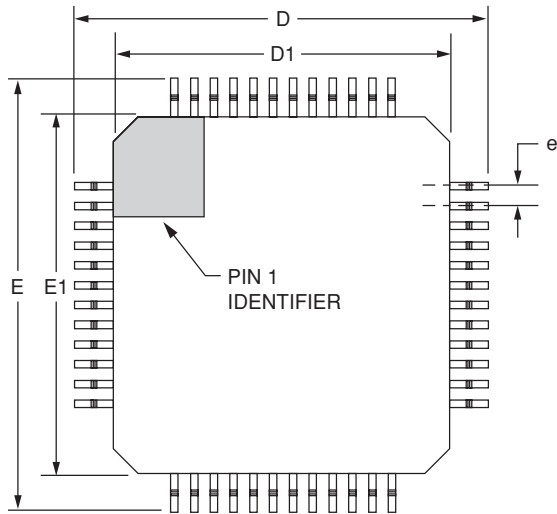

## Ordering Information

| Product Number | Conversion Rate | Lead Free | Temperature Range | Screening  | Package      | Package Marking |
|----------------|-----------------|-----------|-------------------|------------|--------------|-----------------|
| FMS3818KRC     | 180 Ms/s        |           | 0°C to 70°C       | Commercial | 48-Lead LQFP | 3818KRC         |
| FMS3818KRC_NL  | 180 Ms/s        | Yes       | 0°C to 70°C       | Commercial | 48-Lead LQFP | 3818KRC NL      |

### DISCLAIMER

FAIRCHILD SEMICONDUCTOR RESERVES THE RIGHT TO MAKE CHANGES WITHOUT FURTHER NOTICE TO ANY PRODUCTS HEREIN TO IMPROVE RELIABILITY, FUNCTION OR DESIGN. FAIRCHILD DOES NOT ASSUME ANY LIABILITY ARISING OUT OF THE APPLICATION OR USE OF ANY PRODUCT OR CIRCUIT DESCRIBED HEREIN; NEITHER DOES IT CONVEY ANY LICENSE UNDER ITS PATENT RIGHTS, NOR THE RIGHTS OF OTHERS.



### LIFE SUPPORT POLICY

FAIRCHILD'S PRODUCTS ARE NOT AUTHORIZED FOR USE AS CRITICAL COMPONENTS IN LIFE SUPPORT DEVICES OR SYSTEMS WITHOUT THE EXPRESS WRITTEN APPROVAL OF THE PRESIDENT OF FAIRCHILD SEMICONDUCTOR CORPORATION. As used herein:

1. Life support devices or systems are devices or systems which, (a) are intended for surgical implant into the body, or (b) support or sustain life, and (c) whose failure to perform when properly used in accordance with instructions for use provided in the labeling, can be reasonably expected to result in a significant injury of the user.
2. A critical component in any component of a life support device or system whose failure to perform can be reasonably expected to cause the failure of the life support device or system, or to affect its safety or effectiveness.

## Looking for pricing, stock, or lifecycle information?

Click below to explore more details on WIN SOURCE:

-  [View FMS3818KRC on WIN SOURCE](#)
-  [Fairchild/ON Semiconductor Information](#)

## Optimize Your Supply Chain with WIN SOURCE Solutions

-  Global Sourcing Solution
-  Obsolete Management
-  Cost Control Management
-  Shortage Management
-  Alternative Solution
-  Excess Inventory Management