



THE DATASHEET OF FMX-G22S



1. Scope

The present specifications shall apply to Sanken silicon diode, FMX-G22S.

2. Outline

Type	Silicon Diode	
Structure	Resin Molded	Flammability: UL94V-0 (Equivalent)
Applications	High Frequency Rectification, etc.	

3. Absolute maximum ratings

No.	Item	Symbol	Unit	Rating	Conditions
1	Transient Peak Reverse Voltage	V_{RSM}	V	200	
2	Peak Reverse Voltage	V_{RM}	V	200	
3	Average Forward Current	$I_{F(AV)}$	A	10	$T_c=97^\circ\text{C}$, sinewave
4	Peak Surge Forward Current	I_{FSM}	A	150	10msec. 10msec. half sinewave, one shot
5	I^2t Limiting Value	I^2t	A^2s	112.5	
6	Junction Temperature	T_j	$^\circ\text{C}$	- 40 ~ +150	
7	Storage Temperature	T_{stg}	$^\circ\text{C}$	- 40 ~ +150	
8	Dielectric Strength		kV	A.C. 1.0	Junction and case (1min.)

4. Electrical characteristics ($T_a=25^\circ\text{C}$, unless otherwise specified)

No.	Item	Symbol	Unit	Value	Conditions
1	Forward Voltage Drop	V_F	V	0.98 max.	$I_F=10\text{A}$
2	Reverse Leakage Current	I_R	μA	200 max.	$V_R=V_{RM}$
3	Reverse Leakage Current Under High Temperature	$H \cdot I_R$	mA	50 max.	$V_R=V_{RM}$, $T_j=150^\circ\text{C}$
4	Reverse Recovery Time	trr1	ns	30 max.	$I_F=I_{RP}=500\text{mA}$, $T_j=25^\circ\text{C}$ 90% Recovery point
		trr2	ns	25 max.	$I_F=500\text{mA}$, $I_{RP}=1\text{A}$, $T_j=25^\circ\text{C}$ 75% Recovery point
5	Thermal Resistance	$R_{th(j-c)}$	$^\circ\text{C}/\text{W}$	4.0 max.	Between Junction and case.

5. Characteristics

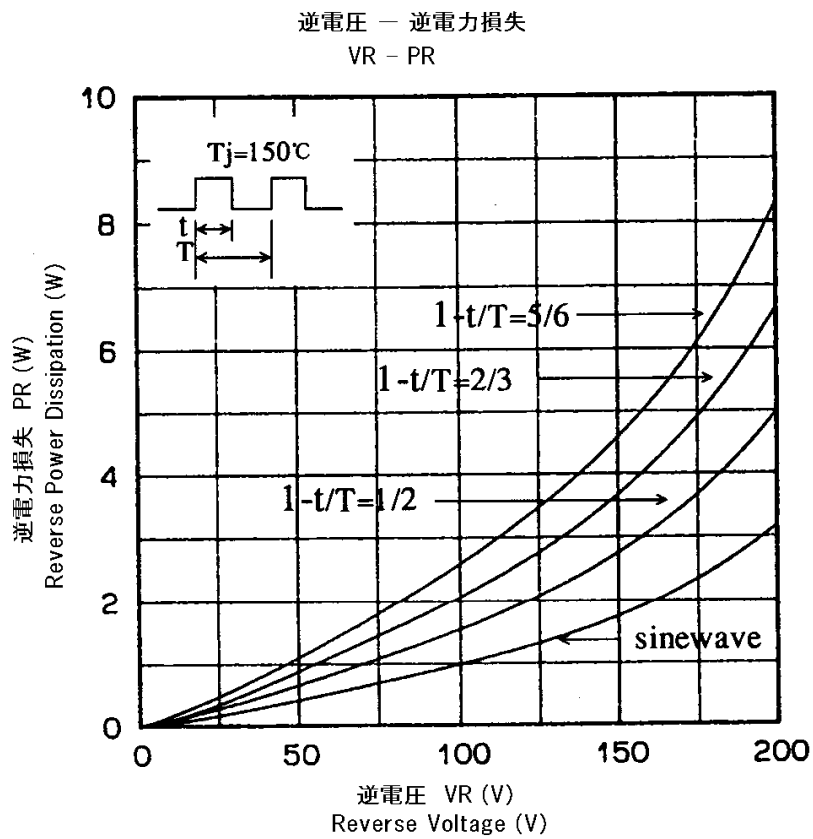
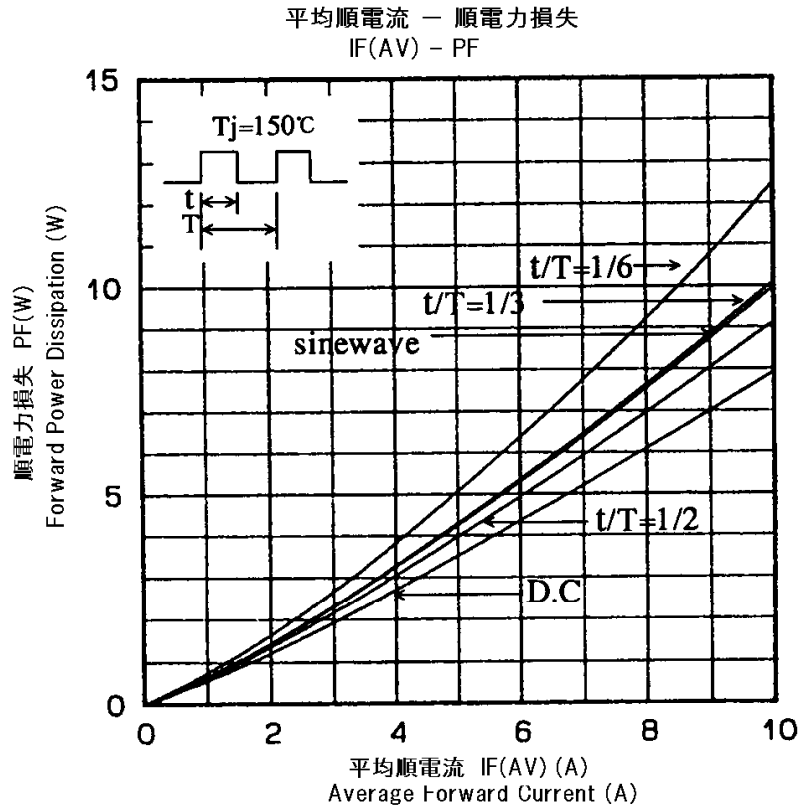

6. Derating Curves

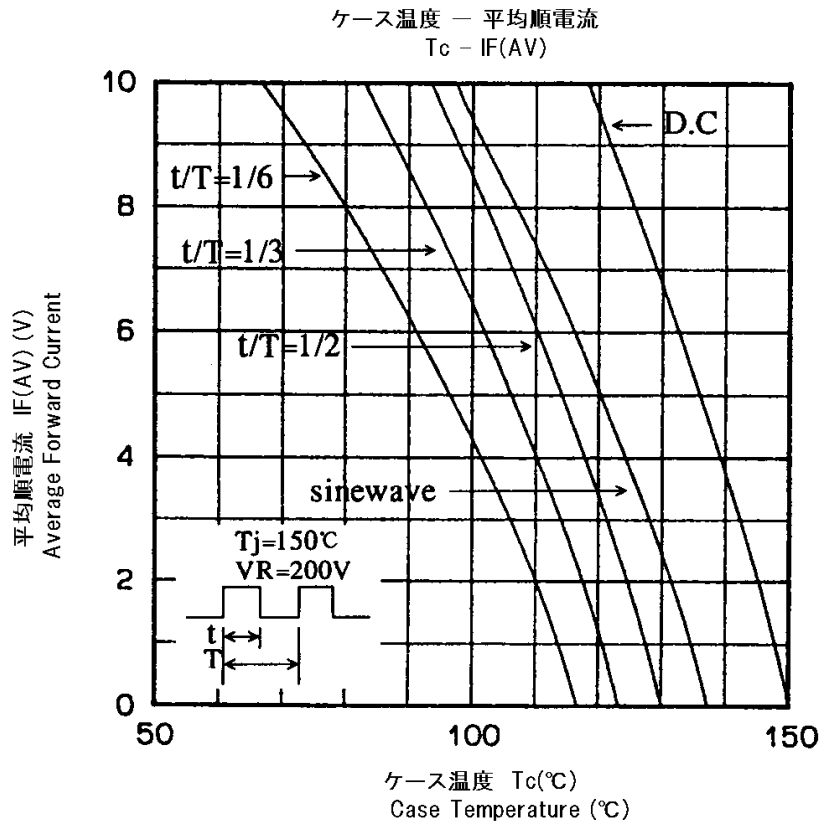

7. Dimensions, Inner Structure and Marking

7-1 Dimensions Refer

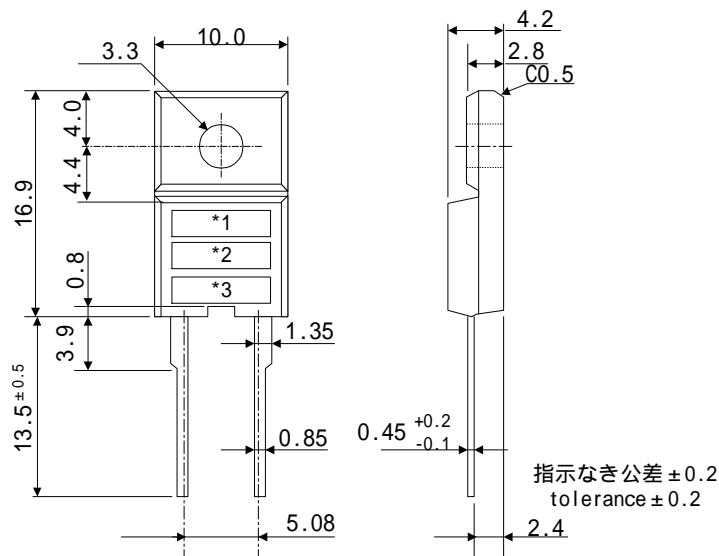

7-2 Appearance



The body shall be clean and shall not bear any stain, rust or flaw.

7-3 Marking







Type Name	Marking		
	*1 Type Name	*2 Polarity	*3 Lot number
FMX-G22S	FMXG22	S	1st letter : Last digit of Year. 2nd letter : Month from 1 to 9 for Jan. to Sep., O for Oct. N for Nov. D for Dec. 3rd&4th letter: Day. Ex. : 3901 (Sep. 1. 2003)

Looking for pricing, stock, or lifecycle information?

Click below to explore more details on WIN SOURCE:

-  [View FMX-G22S](#) on WIN SOURCE
-  [Sanken](#) Information

Optimize Your Supply Chain with WIN SOURCE Solutions

-  Global Sourcing Solution
-  Obsolete Management
-  Cost Control Management
-  Shortage Management
-  Alternative Solution
-  Excess Inventory Management