



**THE DATASHEET OF  
FS6M07652RTCTU**



# FS6M07652RTC

## Fairchild Power Switch(FPS)

### Features

- Fixed Frequency
- Internal Burst Mode Controller for Stand-by Mode
- Pulse By Pulse Over Current Limiting
- Over Current Protection(Auto Restart Mode)
- Over Voltage Protection (Auto Restart Mode)
- Over Load Protection(Auto Restart Mode)
- Internal Thermal Shutdown Function(Latch Mode)
- Under Voltage Lockout
- Internal High Voltage Sense FET
- Soft Start

### Application

- LCD Monitor SMPS
- Adaptor

### Description

The Fairchild Power Switch(FPS) product family is specially designed for an off line SMPS with minimal external components. The Fairchild Power Switch(FPS) consist of a high voltage power SenseFET and a current mode PWM IC. Included PWM controller features integrated fixed oscillator, the under voltage lock out, the leading edge blanking, the optimized gate turn-on/turn-off driver, the thermal shutdown protection, the over voltage protection, and the temperature compensated precision current sources for the loop compensation and a fault protection circuitry. compared with a discrete MOSFET and a controller or a RCC switching converter solution, a Fairchild Power Switch(FPS) can reduce total component count, design size, and weight and at the same time increase efficiency, productivity, and system reliability. It has a basic platform well suited for the cost effective LCD monitor power supply.

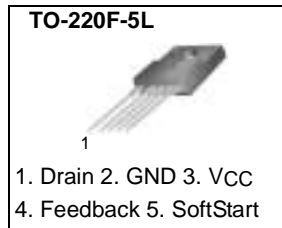

### Internal Block Diagram

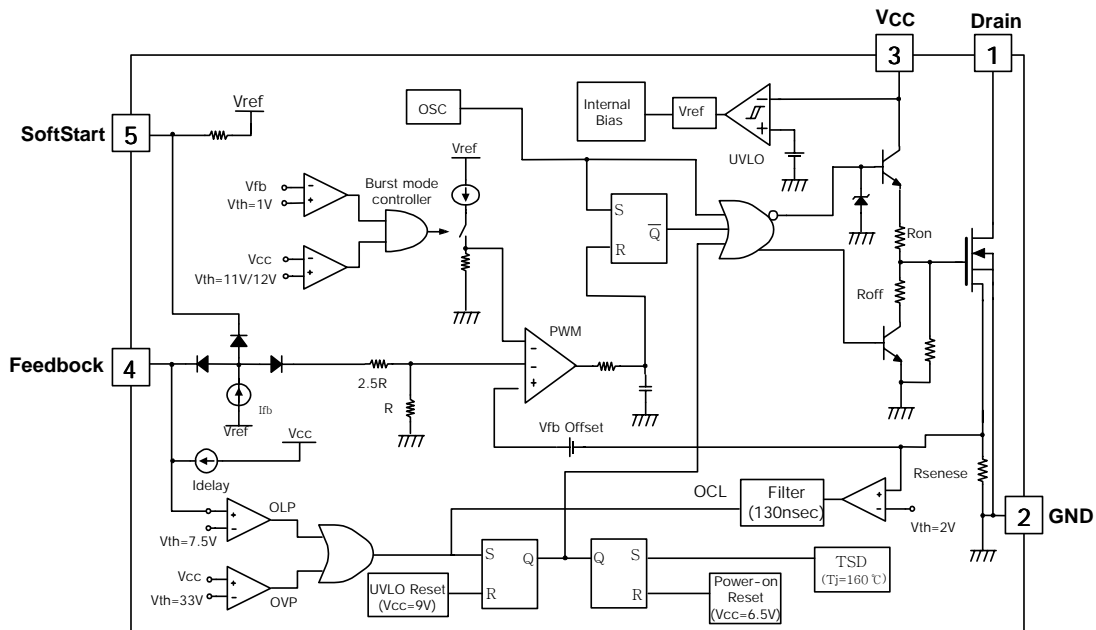

## Absolute Maximum Ratings

(Ta=25°C, unless otherwise specified)

Characteristic	Symbol	Value	Unit
Drain-Gate Voltage (RGS=1MΩ)	VDGR	650	V
Gate-Source (GND) Voltage	VGS	±30	V
Drain Current Pulsed <sup>(1)</sup>	IDM	14.4	ADC
Continuous Drain Current (Tc = 25°C)	ID	3.6	ADC
Continuous Drain Current (TC=100°C)	ID	2.28	ADC
Single Pulsed Avalanche Current <sup>(3)</sup> (Energy <sup>(2)</sup> )	IAS(EAS)	17(570)	A(mJ)
Maximum Supply Voltage	VCC, MAX	35	V
Input Voltage Range	VFB	-0.3 to VCC	V
	VSS	-0.3 to 10	V
Total Power Dissipation	PD(Watt H/S)	46	W
	Darting	0.37	W/°C
Operating Junction Temperature	Tj	+150	°C
Operating Ambient Temperature	TA	-25 to +85	°C
Storage Temperature Range	TSTG	-55 to +150	°C

### Notes:

1. Repetitive rating: Pulse width limited by maximum junction temperature
2. L=81mH, starting Tj=25°C
3. L=13uH, starting Tj=25°C

## Electrical Characteristics (SFET part)

(Ta=25°C unless otherwise specified)

Parameter	Symbol	Condition	Min.	Typ.	Max.	Unit
Drain-Source Breakdown Voltage	BVDSS	VGS=0V, ID=250μA	650	-	-	V
Zero Gate Voltage Drain Current	IDSS	VDS=650V, VGS=0V	-	-	200	μA
		VDS=520V VGS=0V, TC=125°C	-	-	300	μA
Static Drain-Source On Resistance <sup>(1)</sup>	RDS(ON)	VGS=10V, ID=1.8A	-	1.3	1.6	Ω
Forward Transconductance <sup>(2)</sup>	gfs	VDS=50V, ID=1.8A	-	3.3	-	S
Input Capacitance	Ciss	VGS=0V, VDS=25V, f = 1MHz	-	1200	-	pF
Output Capacitance	Coss		-	125	-	
Reverse Transfer Capacitance	Crss		-	23	-	
Turn On Delay Time	td(on)	VDD=325V, ID=6.5A (MOSFET switching time is essentially independent of operating temperature)	-	22	-	nS
Rise Time	tr		-	70	-	
Turn Off Delay Time	td(off)		-	105	-	
Fall Time	tf		-	65	-	
Total Gate Charge (Gate-Source+Gate-Drain)	Qg	VGS=10V, ID=6.5A, VDS=520V (MOSFET switching time is essentially independent of operating temperature)	-	40	-	nC
Gate-Source Charge	Qgs		-	6.5	-	
Gate-Drain (Miller) Charge	Qgd		-	18	-	

**Note:**

1. Pulse test : Pulse width ≤ 300μS, duty 2%

2.  $S = \frac{1}{R}$

**Electrical Characteristics** (Continued)

(Ta=25°C unless otherwise specified)

Parameter	Symbol	Condition	Min.	Typ.	Max.	Unit
<b>UVLO SECTION</b>						
Start Threshold Voltage	VSTART	VFB = GND	14	15	16	V
Stop Threshold Voltage	VSTOP	VFB = GND	8	9	10	V
<b>OSCILLATOR SECTION</b>						
Initial Frequency	FOSC	-	63	70	77	kHz
Voltage Stability	FSTABLE	12V ≤ VCC ≤ 23V	0	1	3	%
Temperature Stability (2)	ΔFOSC	-25°C ≤ Ta ≤ 85°C	0	±5	±10	%
Maximum Duty Cycle	DMAX	-	75	80	85	%
Minimum Duty Cycle	DMIN	-	-	-	0	%
<b>FEEDBACK SECTION</b>						
Feedback Source Current	IFB	VFB = GND	0.7	0.9	1.1	mA
Shutdown Feedback Voltage	VSD	VFB ≥ 6.9V	6.9	7.5	8.1	V
Shutdown Delay Current	IDELAY	VFB = 5V	3.2	4.0	4.8	μA
<b>SOFTSTART SECTION</b>						
Softstart Voltage	VSS	VFB = 2	4.7	5.0	5.3	V
Softstart Current	ISS	VSS = V	0.8	1.0	1.2	mA
<b>BURST MODE SECTION</b>						
Burst Mode Low Threshold Voltage	VBURL	VFB = 0V	10.4	11.0	11.6	V
Burst Mode High Threshold Voltage	VBURH	VFB = 0V	11.4	12.0	12.6	V
Burst Mode Enable Feedback Voltage	VBEN	VCC = 10.5V	0.7	1.0	1.3	V
Burst Mode Peak Current Limit (4)	IBURPK	VCC = 10.5V, VFB = 0V	0.38	0.5	0.62	A
Burst Mode Frequency	FBUR	VCC = 10.5V, VFB = 0V	63	70	77	kHz
<b>CURRENT LIMIT(SELF-PROTECTION)SECTION</b>						
Peak Current Limit (4)	IOVER	-	1.76	2.0	2.24	A
<b>PROTECTION SECTION</b>						
Over Voltage Protection	VOVP	VCC ≥ 29V	29	33	37	V
Over Current Latch Voltage (3)	VOCL	-	1.8	2.0	2.2	V
Thermal Shutdown Temp (2)	TSD	-	140	160	-	°C
<b>TOTAL DEVICE SECTION</b>						
Start Up Current	ISTART	VFB = GND, VCC = 14V	-	0.1	0.17	mA
Operating Supply Current (1)	IOP	VFB = GND, VCC = 16V	-	10	15	mA
	IOP(MIN)	VFB = GND, VCC = 12V				
	IOP(MAX)	VFB = GND, VCC = 30V				

**Notes:**

1. These parameters are the current flowing in the control IC.
2. These parameters, although guaranteed at the design, are not 100% tested in production.
3. These parameters, although guaranteed, are tested in EDS(wafer test) process.
4. These parameters indicate inductor current.

## Typical Performance Characteristics

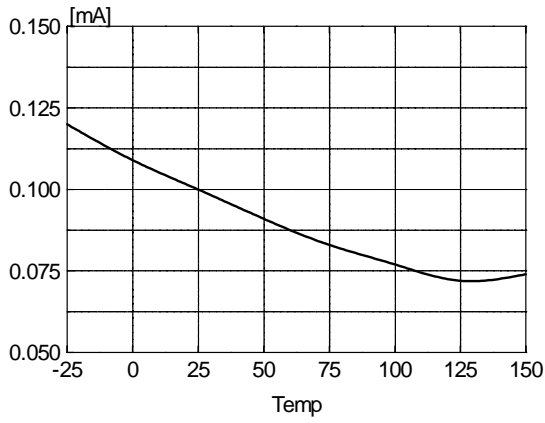

Figure 1. Start Up Current vs. Temp

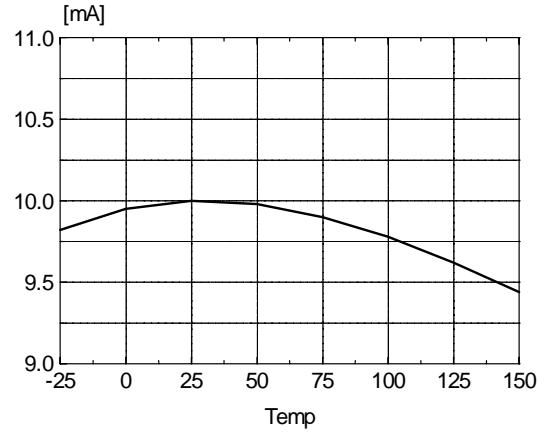

Figure 2. Operating Current vs. Temp

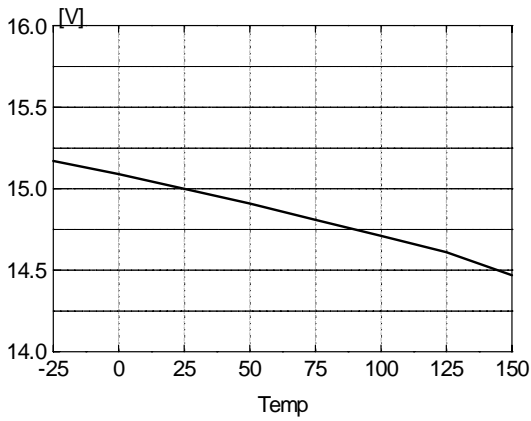

Figure 3. Start Threshold Voltage vs. Temp

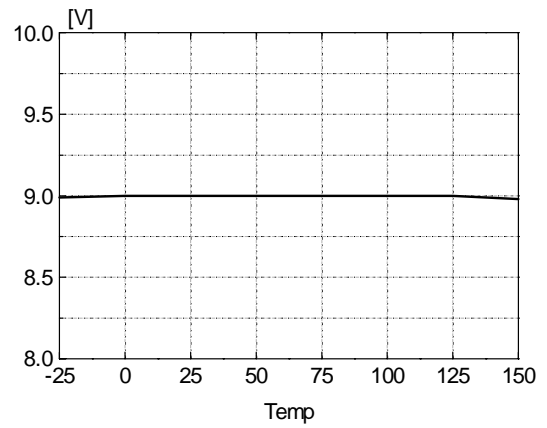

Figure 4. Stop Threshold Voltage vs. Temp

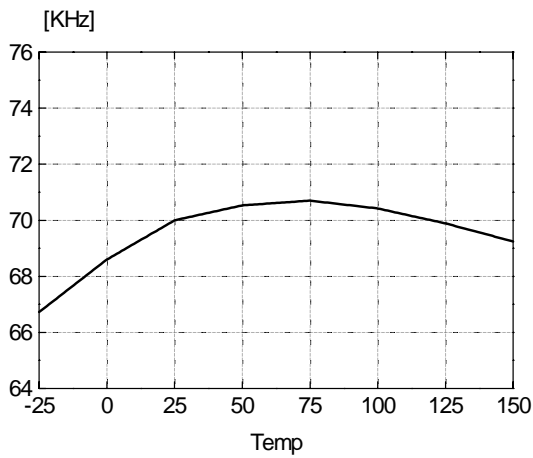

Figure 5. Initial Frequency vs. Temp

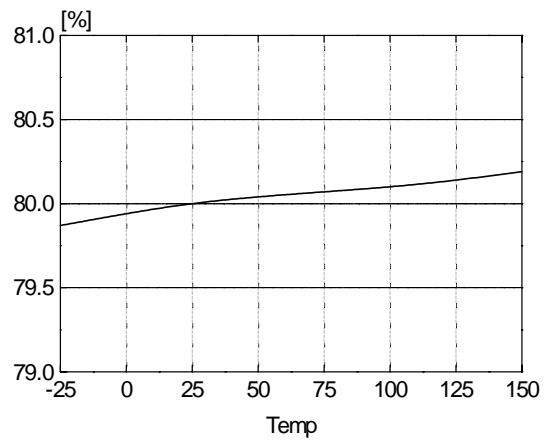

Figure 6. Maximum Duty vs. Temp

Typical Performance Characteristics (Continued)

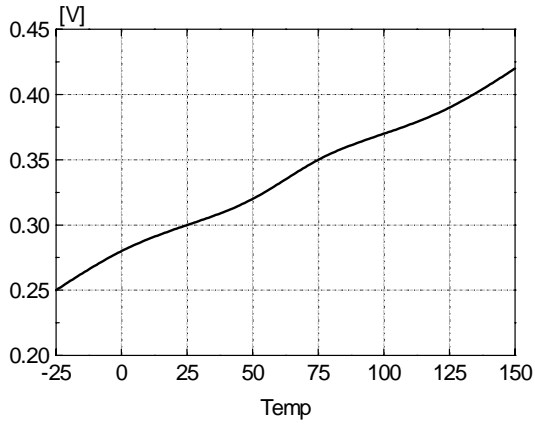

Figure 7. Feedback Offset Voltage vs. Temp

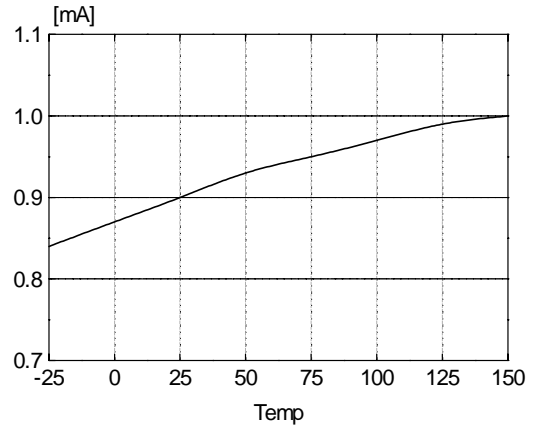

Figure 8. Feedback Source Current vs. Temp

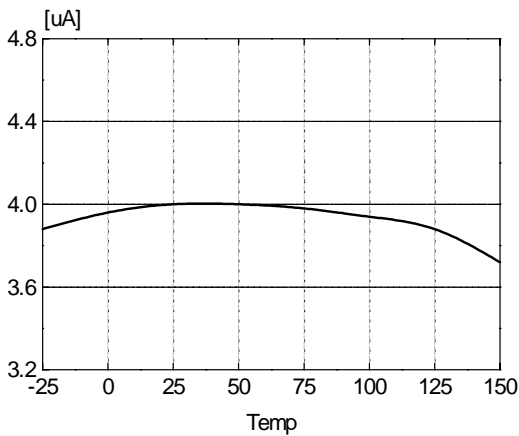

Figure 9. ShutDown Delay Current vs. Temp

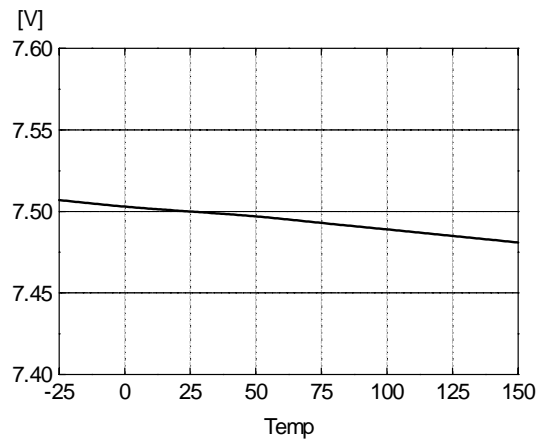

Figure 10. ShutDown Feedback Voltage vs. Temp

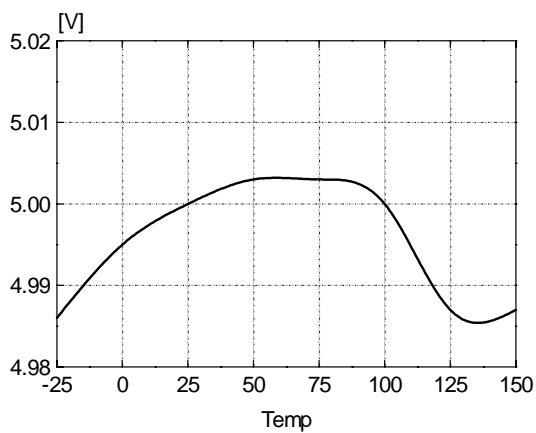

Figure 11. Softstart Voltage vs. Temp

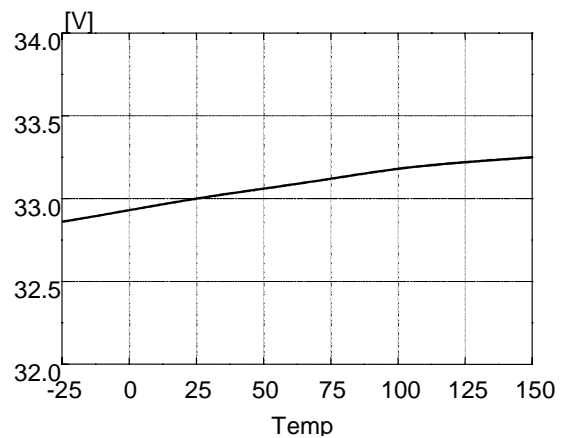
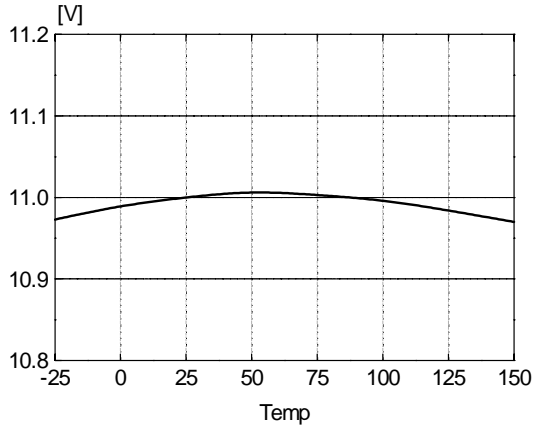
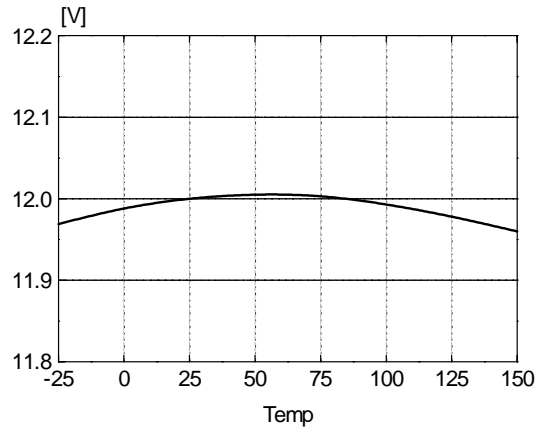

Figure 12. Over Voltage Protection vs. Temp

**Typical Performance Characteristics** (Continued)



**Figure 13. Burst Mode Low Voltage vs. Temp**



**Figure 14. Burst Mode High Voltage vs. Temp**

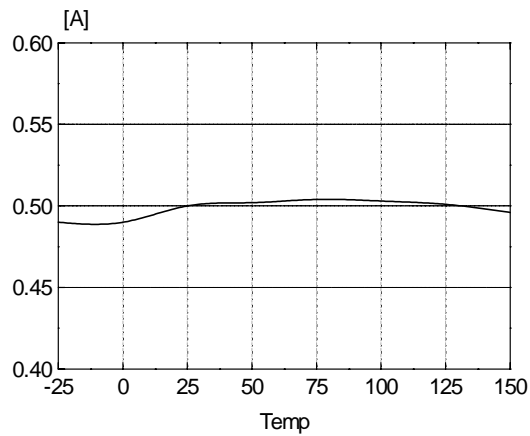

**Figure 15. Burst Mode Peak Current vs. Temp**

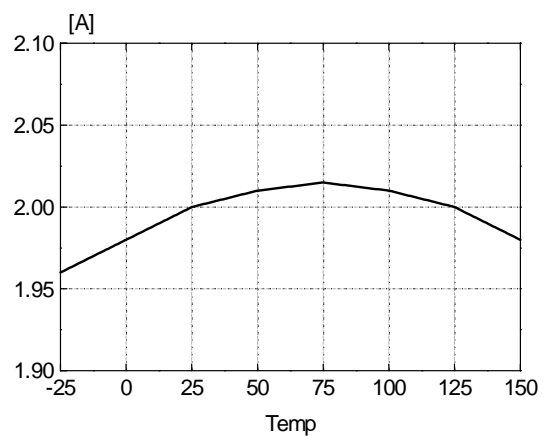

**Figure 16. Over Current Limit vs. Temp**

# Package Dimensions

## TO-220F-5L

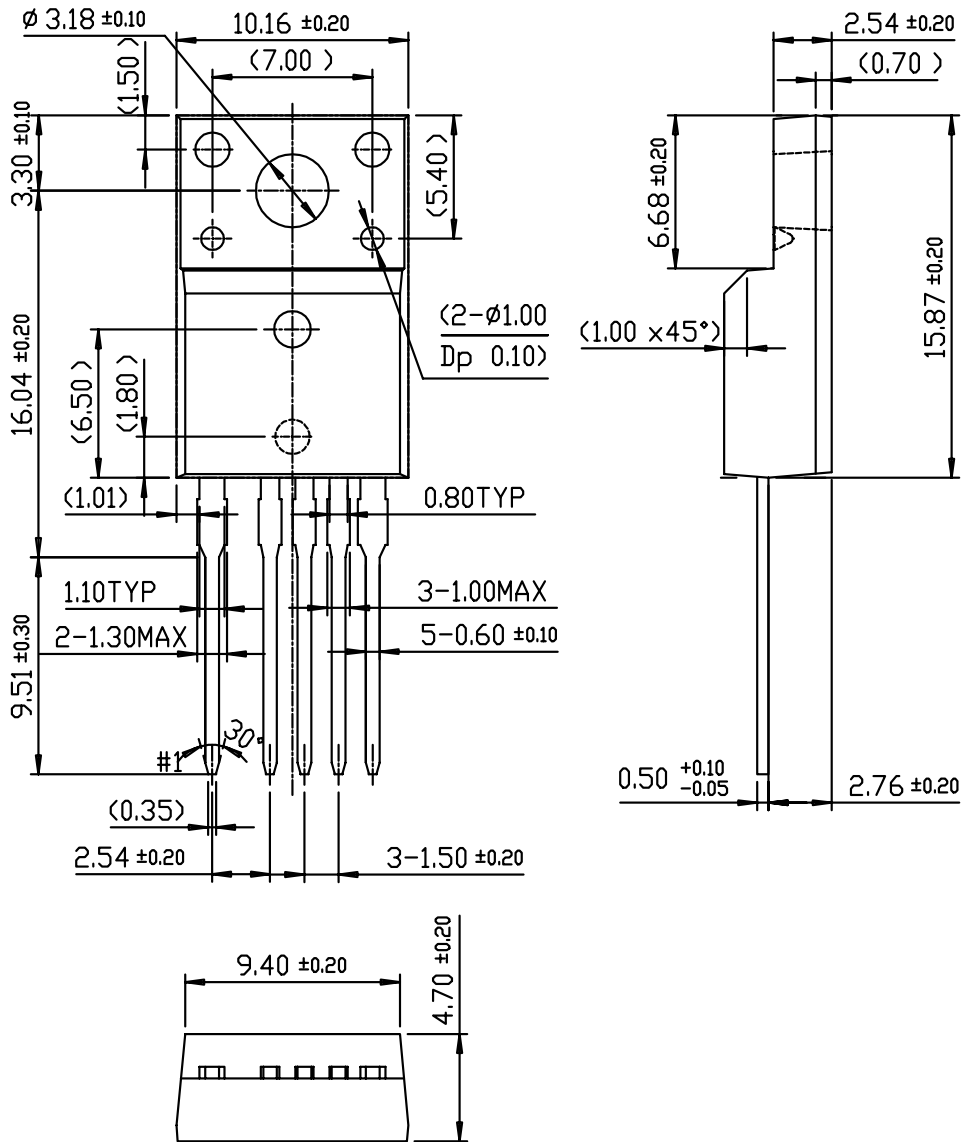



## Ordering Information

Product Number	Package	Marking Code	BVdss	Rds(on)
FS6M07652RTCTU	TO-220F-5L	6M07652R C	650V	1.6
FS6M07652RTCYDT	TO-220F-5L(Forming)			

TU : Non Forming Type

YDT : Forming Type

### DISCLAIMER

FAIRCHILD SEMICONDUCTOR RESERVES THE RIGHT TO MAKE CHANGES WITHOUT FURTHER NOTICE TO ANY PRODUCTS HEREIN TO IMPROVE RELIABILITY, FUNCTION OR DESIGN. FAIRCHILD DOES NOT ASSUME ANY LIABILITY ARISING OUT OF THE APPLICATION OR USE OF ANY PRODUCT OR CIRCUIT DESCRIBED HEREIN; NEITHER DOES IT CONVEY ANY LICENSE UNDER ITS PATENT RIGHTS, NOR THE RIGHTS OF OTHERS.



### LIFE SUPPORT POLICY

FAIRCHILD'S PRODUCTS ARE NOT AUTHORIZED FOR USE AS CRITICAL COMPONENTS IN LIFE SUPPORT DEVICES OR SYSTEMS WITHOUT THE EXPRESS WRITTEN APPROVAL OF THE PRESIDENT OF FAIRCHILD SEMICONDUCTOR CORPORATION. As used herein:

1. Life support devices or systems are devices or systems which, (a) are intended for surgical implant into the body, or (b) support or sustain life, and (c) whose failure to perform when properly used in accordance with instructions for use provided in the labeling, can be reasonably expected to result in a significant injury of the user.
2. A critical component in any component of a life support device or system whose failure to perform can be reasonably expected to cause the failure of the life support device or system, or to affect its safety or effectiveness.

## Looking for pricing, stock, or lifecycle information?

Click below to explore more details on WIN SOURCE:

-  [View FS6M07652RTCTU on WIN SOURCE](#)
-  [Fairchild/ON Semiconductor Information](#)

## Optimize Your Supply Chain with WIN SOURCE Solutions

-  Global Sourcing Solution
-  Obsolete Management
-  Cost Control Management
-  Shortage Management
-  Alternative Solution
-  Excess Inventory Management