



GAL[®]18V10 Device Datasheet

September 2010

All Devices Discontinued!

Product Change Notifications (PCNs) have been issued to discontinue all devices in this data sheet.

The original datasheet pages have not been modified and do not reflect those changes. Please refer to the table below for reference PCN and current product status.

Product Line	Ordering Part Number	Product Status	Reference PCN
GAL18V10	GAL18V10B-7LJ	Discontinued	PCN#06-07
	GAL18V10B-7LP		
	GAL18V10B-10LJ		
	GAL18V10B-10LP		
	GAL18V10B-15LJ		
	GAL18V10B-15LP		
	GAL18V10B-20LJ		
	GAL18V10B-20LP		
			PCN#13-10

Features

- **HIGH PERFORMANCE E²CMOS® TECHNOLOGY**
 - 7.5 ns Maximum Propagation Delay
 - Fmax = 111 MHz
 - 5.5 ns Maximum from Clock Input to Data Output
 - TTL Compatible 16 mA Outputs
 - UltraMOS® Advanced CMOS Technology
- **LOW POWER CMOS**
 - 75 mA Typical Icc
- **ACTIVE PULL-UPS ON ALL PINS**
- **E² CELL TECHNOLOGY**
 - Reconfigurable Logic
 - Reprogrammable Cells
 - 100% Tested/100% Yields
 - High Speed Electrical Erasure (<100ms)
 - 20 Year Data Retention
- **TEN OUTPUT LOGIC MACROCELLS**
 - Uses Standard 22V10 Macrocell Architecture
 - Maximum Flexibility for Complex Logic Designs
- **PRELOAD AND POWER-ON RESET OF REGISTERS**
 - 100% Functional Testability
- **APPLICATIONS INCLUDE:**
 - DMA Control
 - State Machine Control
 - High Speed Graphics Processing
 - Standard Logic Speed Upgrade
- **ELECTRONIC SIGNATURE FOR IDENTIFICATION**

Functional Block Diagram



Description

The GAL18V10, at 7.5 ns maximum propagation delay time, combines a high performance CMOS process with Electrically Erasable (E²) floating gate technology to provide a very flexible 20-pin PLD. CMOS circuitry allows the GAL18V10 to consume much less power when compared to its bipolar counterparts. The E² technology offers high speed (<100ms) erase times, providing the ability to reprogram or reconfigure the device quickly and efficiently.

By building on the popular 22V10 architecture, the GAL18V10 eliminates the learning curve usually associated with using a new device architecture. The generic architecture provides maximum design flexibility by allowing the Output Logic Macrocell (OLMC) to be configured by the user. The GAL18V10 OLMC is fully compatible with the OLMC in standard bipolar and CMOS 22V10 devices.

Unique test circuitry and reprogrammable cells allow complete AC, DC, and functional testing during manufacture. As a result, Lattice Semiconductor delivers 100% field programmability and functionality of all GAL products. In addition, 100 erase/write cycles and data retention in excess of 20 years are specified.

Pin Configuration

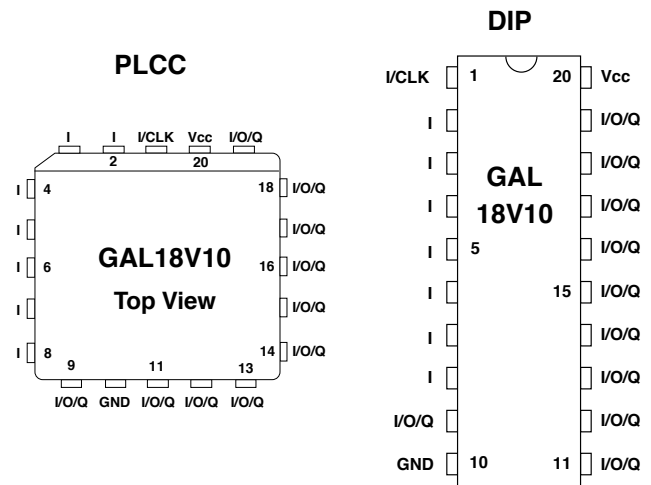

Copyright © 2003 Lattice Semiconductor Corp. All brand or product names are trademarks or registered trademarks of their respective holders. The specifications and information herein are subject to change without notice.

GAL18V10 Ordering Information

Commercial Grade Specifications

Tpd (ns)	Tsu (ns)	Tco (ns)	Icc (mA)	Ordering #	Package
7.5	6	5.5	115	GAL18V10B-7LP ¹	20-Pin Plastic DIP
			115	GAL18V10B-7LJ ¹	20-Lead PLCC
10	7	7	115	GAL18V10B-10LP	20-Pin Plastic DIP
			115	GAL18V10B-10LJ	20-Lead PLCC
15	8	10	115	GAL18V10B-15LP	20-Pin Plastic DIP
			115	GAL18V10B-15LJ	20-Lead PLCC
20	12	12	115	GAL18V10B-20LP	20-Pin Plastic DIP
			115	GAL18V10B-20LJ	20-Lead PLCC

1. Discontinued per PCN #06-07. Contact Rochester Electronics for available inventory.

Part Number Description

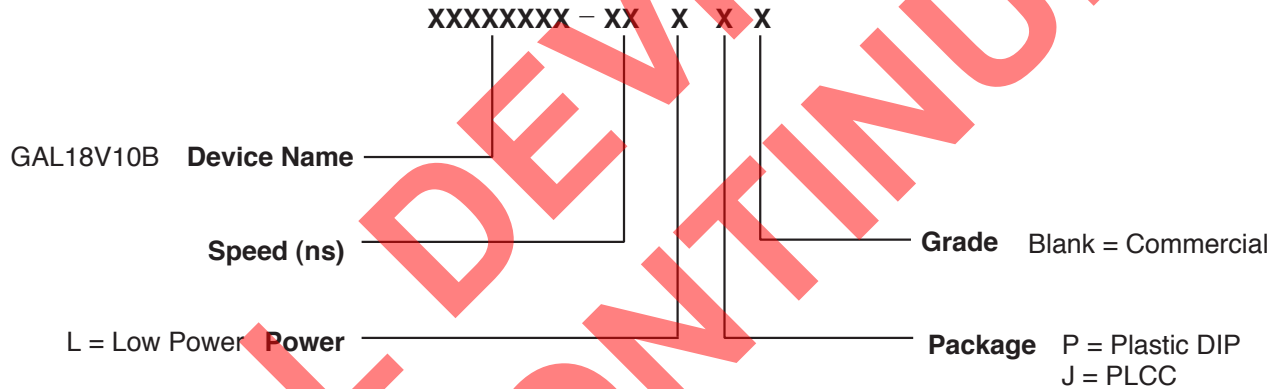

Output Logic Macrocell (OLMC)

The GAL18V10 has a variable number of product terms per OLMC. Of the ten available OLMCs, two OLMCs have access to ten product terms (pins 14 and 15), and the other eight OLMCs have eight product terms each. In addition to the product terms available for logic, each OLMC has an additional product-term dedicated to output enable control.

The output polarity of each OLMC can be individually programmed to be true or inverting, in either combinatorial or registered mode. This allows each output to be individually configured as either active high or active low.

The GAL18V10 has a product term for Asynchronous Reset (AR) and a product term for Synchronous Preset (SP). These two product terms are common to all registered OLMCs. The Asynchronous Reset sets all registered outputs to zero any time this dedicated product term is asserted. The Synchronous Preset sets all registers to a logic one on the rising edge of the next clock pulse after this product term is asserted.

NOTE: The AR and SP product terms will force the Q output of the flip-flop into the same state regardless of the polarity of the output. Therefore, a reset operation, which sets the register output to a zero, may result in either a high or low at the output pin, depending on the pin polarity chosen.

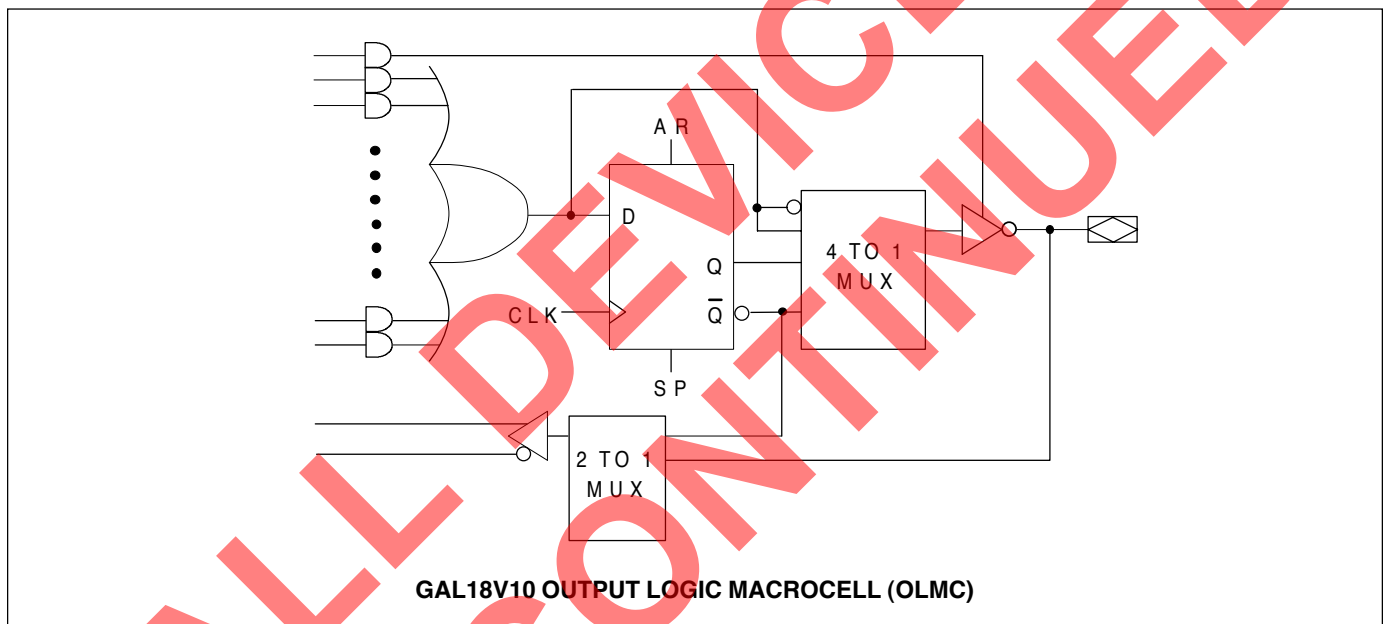

Output Logic Macrocell Configurations

Each of the Macrocells of the GAL18V10 has two primary functional modes: registered, and combinatorial I/O. The modes and the output polarity are set by two bits (S0 and S1), which are normally controlled by the logic compiler. Each of these two primary modes, and the bit settings required to enable them, are described below and on the the following page.

REGISTERED

In registered mode the output pin associated with an individual OLMC is driven by the Q output of that OLMC's D-type flip-flop. Logic polarity of the output signal at the pin may be selected by specifying that the output buffer drive either true (active high) or inverted (active low). Output tri-state control is available as an individual product term for each OLMC, and can therefore be defined by a logic equation. The D flip-flop's /Q output is fed back into the AND array, with both the true and complement of the feedback available as inputs to the AND array.

NOTE: In registered mode, the feedback is from the /Q output of the register, and not from the pin; therefore, a pin defined as registered is an output only, and cannot be used for dynamic I/O, as can the combinatorial pins.

COMBINATORIAL I/O

In combinatorial mode the pin associated with an individual OLMC is driven by the output of the sum term gate. Logic polarity of the output signal at the pin may be selected by specifying that the output buffer drive either true (active high) or inverted (active low). Output tri-state control is available as an individual product-term for each output, and may be individually set by the compiler as either "on" (dedicated output), "off" (dedicated input), or "product-term driven" (dynamic I/O). Feedback into the AND array is from the pin side of the output enable buffer. Both polarities (true and inverted) of the pin are fed back into the AND array.

Registered Mode

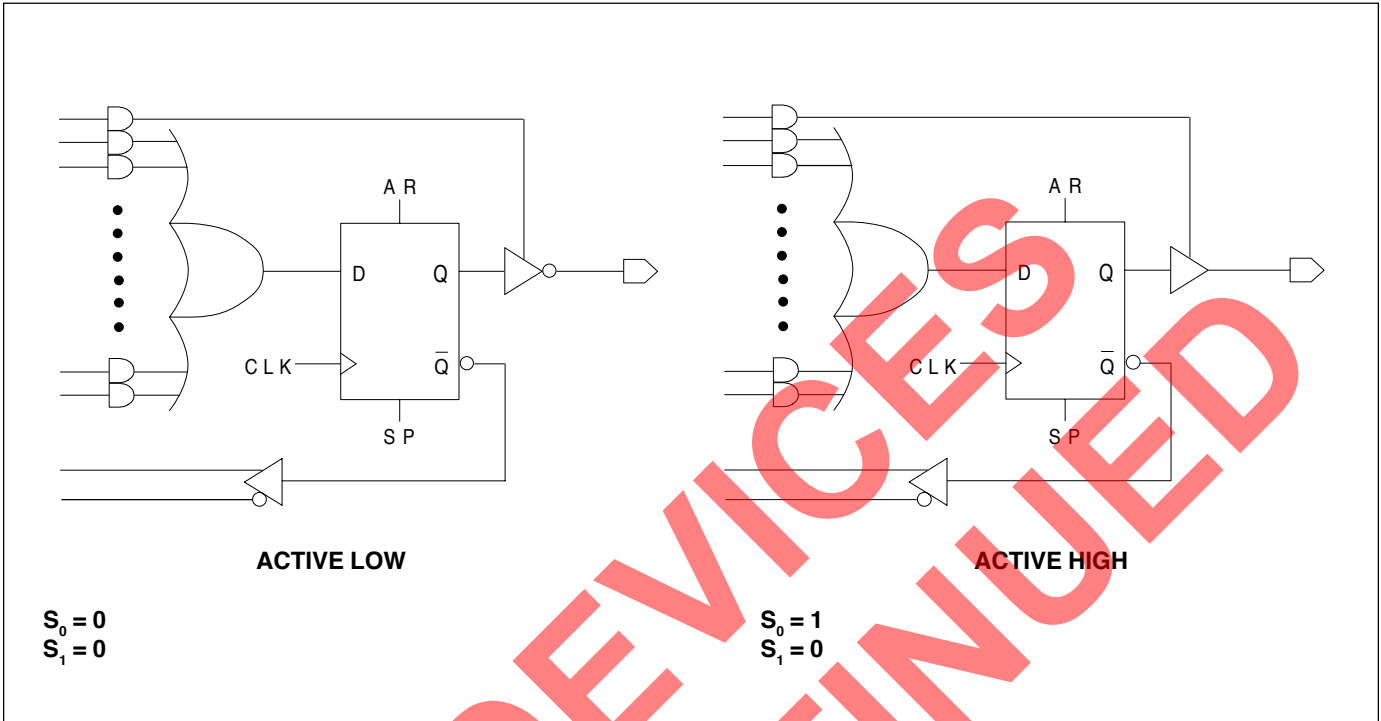

Combinatorial Mode

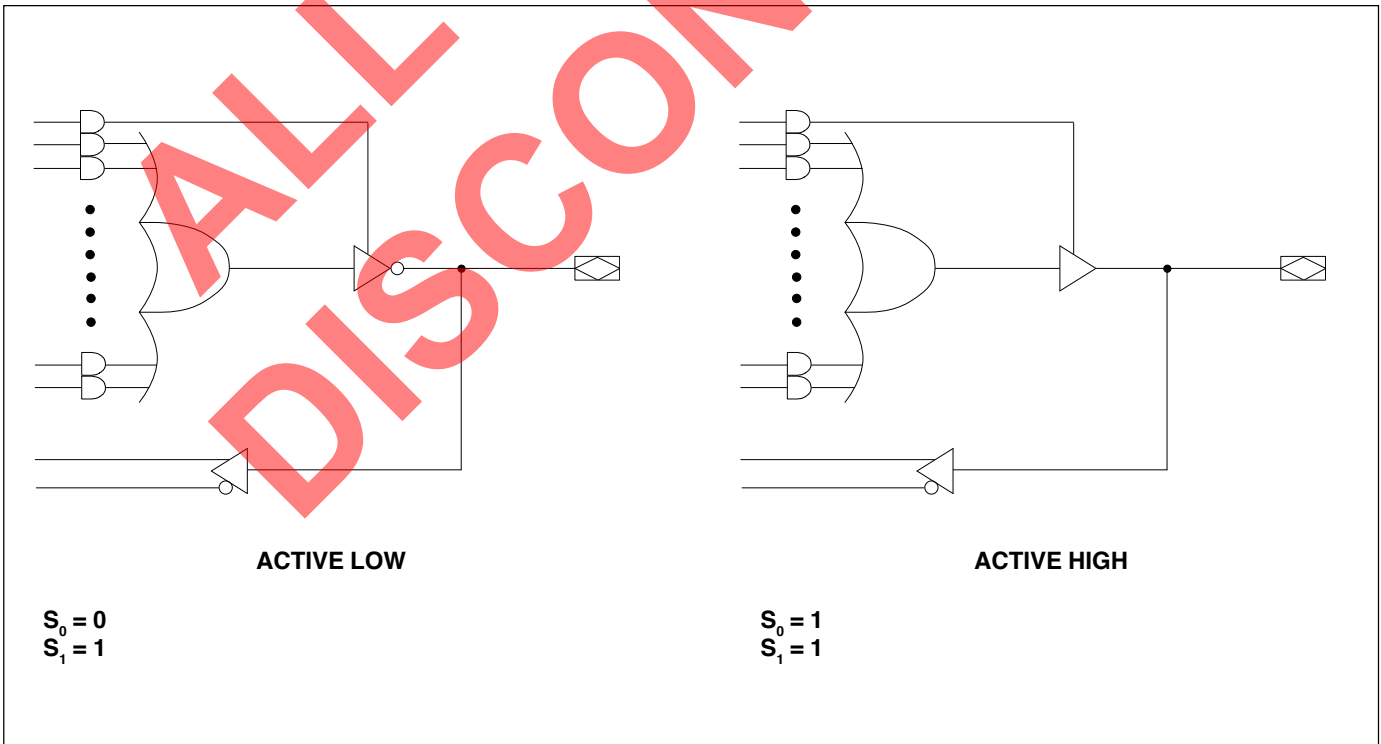

GAL18V10 Logic Diagram/JEDEC Fuse Map

DIP and PLCC Package Pinouts

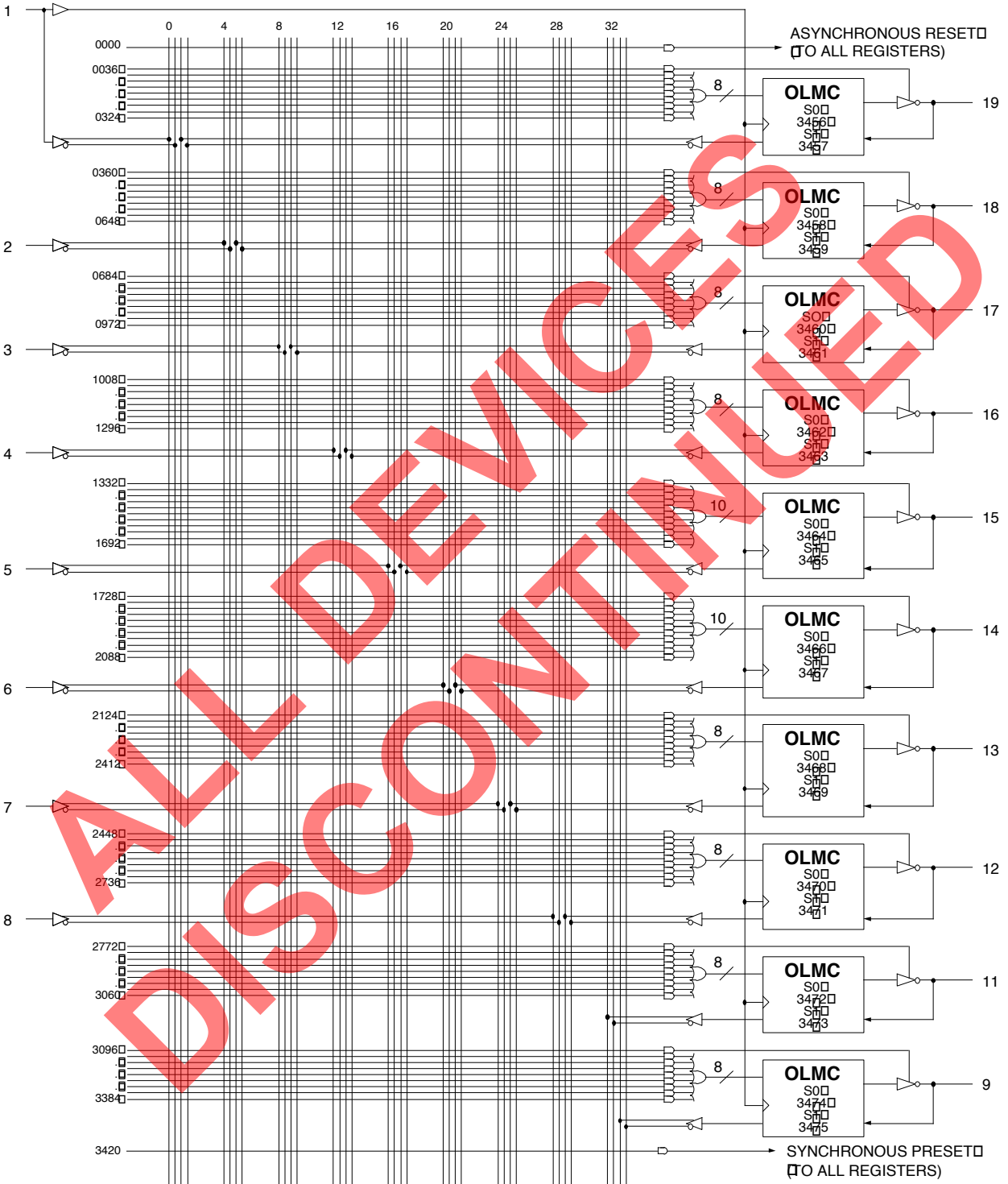

3476, 3477 ... Electronic Signature ... 3538, 3539							
Byte 7	Byte 6	Byte 5	Byte 4	Byte 3	Byte 2	Byte 1	Byte 0
M	LD	LD	LD	LD	LD	LD	LD
S	B	B	B	B	B	B	B

Absolute Maximum Ratings⁽¹⁾

Supply voltage V_{CC} -0.5 to +7V
 Input voltage applied -2.5 to $V_{CC} + 1.0V$
 Off-state output voltage applied -2.5 to $V_{CC} + 1.0V$
 Storage Temperature -65 to 150°C
 Ambient Temperature with
 Power Applied -55 to 125°C

1. Stresses above those listed under the “Absolute Maximum Ratings” may cause permanent damage to the device. These are stress only ratings and functional operation of the device at these or at any other conditions above those indicated in the operational sections of this specification is not implied (while programming, follow the programming specifications).

Recommended Operating Conditions

Commercial Devices:
 Ambient Temperature (T_A) 0 to +75°C
 Supply voltage (V_{CC})
 with Respect to Ground +4.75 to +5.25V

DC Electrical Characteristics

Over Recommended Operating Conditions (Unless Otherwise Specified)

SYMBOL	PARAMETER	CONDITION	MIN.	TYP. ³	MAX.	UNITS
V_{IL}	Input Low Voltage		$V_{SS} - 0.5$	—	0.8	V
V_{IH}	Input High Voltage		2.0	—	$V_{CC} + 1$	V
I_{IL}¹	Input or I/O Low Leakage Current	$0V \leq V_{IN} \leq V_{IL} (MAX.)$	—	—	-100	μA
I_{IH}	Input or I/O High Leakage Current	$3.5V \leq V_{IN} \leq V_{CC}$	—	—	10	μA
V_{OL}	Output Low Voltage	$I_{OL} = MAX., V_{IN} = V_{IL} \text{ or } V_{IH}$	—	—	0.5	V
V_{OH}	Output High Voltage	$I_{OH} = MAX., V_{IN} = V_{IL} \text{ or } V_{IH}$	2.4	—	—	V
I_{OL}	Low Level Output Current		—	—	16	mA
I_{OH}	High Level Output Current		—	—	-3.2	mA
I_{OS}²	Output Short Circuit Current	$V_{CC} = 5V, V_{OUT} = 0.5V, T_A = 25^\circ C$	-30	—	-130	mA

COMMERCIAL

I_{CC}	Operating Power Supply Current	$V_{IL} = 0.5V, V_{IH} = 3.0V$ $f_{toggle} = 15MHz$ Outputs Open	L -7/-10/-15/-20	—	75	115	mA
-----------------------	-----------------------------------	---	------------------	---	----	-----	----

- 1) The leakage current is due to the internal pull-up on all pins. See **Input Buffer** section for more information.
- 2) One output at a time for a maximum duration of one second. $V_{out} = 0.5V$ was selected to avoid test problems caused by tester ground degradation. Characterized but not 100% tested.
- 3) Typical values are at $V_{CC} = 5V$ and $T_A = 25^\circ C$

AC Switching Characteristics

Over Recommended Operating Conditions

PARAM.	TEST COND. ¹	DESCRIPTION	COM		COM		COM		COM		UNITS
			-7		-10		-15		-20		
			MIN.	MAX.	MIN.	MAX.	MIN.	MAX.	MIN.	MAX.	
t_{pd}	A	Input or I/O to Comb. Output	—	7.5	—	10	—	15	—	20	ns
t_{co}	A	Clock to Output Delay	—	5.5	—	7	—	10	—	12	ns
t_{cf}²	—	Clock to Feedback Delay	—	3.5	—	3.5	—	7	—	10	ns
t_{su}	—	Setup Time, Input or Fdbk before Clk↑	5.5	—	6	—	8	—	12	—	ns
t_h	—	Hold Time, Input or Fdbk after Clk↑	0	—	0	—	0	—	0	—	ns
f_{max}³	A	Maximum Clock Frequency with External Feedback, 1/(t _{su} + t _{co})	90.9	—	76.9	—	55.5	—	41.6	—	MHz
	A	Maximum Clock Frequency with Internal Feedback, 1/(t _{su} + t _{cf})	111	—	105	—	66.7	—	45.4	—	MHz
	A	Maximum Clock Frequency with No Feedback	111	—	105	—	66.7	—	62.5	—	MHz
t_{wh}	—	Clock Pulse Duration, High	4	—	4	—	6	—	8	—	ns
t_{wl}	—	Clock Pulse Duration, Low	4	—	4	—	6	—	8	—	ns
t_{en}	B	Input or I/O to Output Enabled	—	8	—	10	—	15	—	20	ns
t_{dis}	C	Input or I/O to Output Disabled	—	8	—	9	—	15	—	20	ns
t_{ar}	A	Input or I/O to Asynch. Reset of Reg.	—	13	—	13	—	20	—	20	ns
t_{arw}	—	Asynch. Reset Pulse Duration	8	—	8	—	10	—	15	—	ns
t_{arr}	—	Asynch. Reset to Clk↑ Recovery Time	8	—	8	—	10	—	15	—	ns
t_{spr}	—	Synch. Preset to Clk↑ Recovery Time	10	—	10	—	10	—	12	—	ns

1) Refer to **Switching Test Conditions** section.

2) Calculated from f_{max} with internal feedback. Refer to **f_{max} Description** section.

3) Refer to **f_{max} Description** section.

Capacitance (T_A = 25°C, f = 1.0 MHz)

SYMBOL	PARAMETER	MAXIMUM*	UNITS	TEST CONDITIONS
C _I	Input Capacitance	8	pF	V _{CC} = 5.0V, V _I = 2.0V
C _{I/O}	I/O Capacitance	8	pF	V _{CC} = 5.0V, V _{I/O} = 2.0V

*Characterized but not 100% tested.

Switching Waveforms

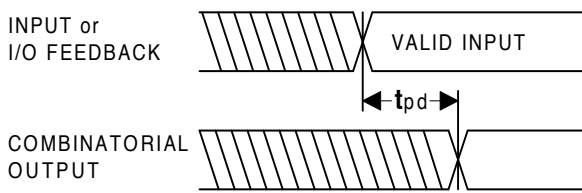

Combinatorial Output

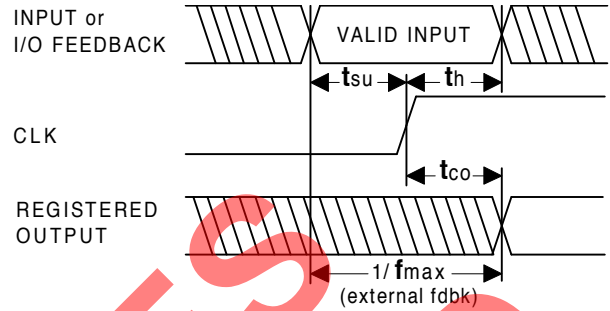

Registered Output

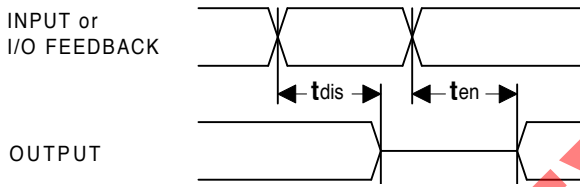

Input or I/O to Output Enable/Disable

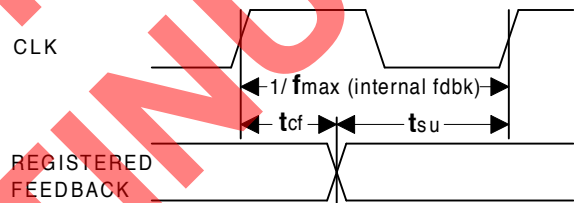

fmax with Feedback

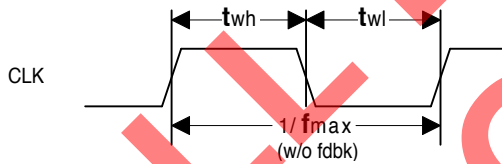

Clock Width

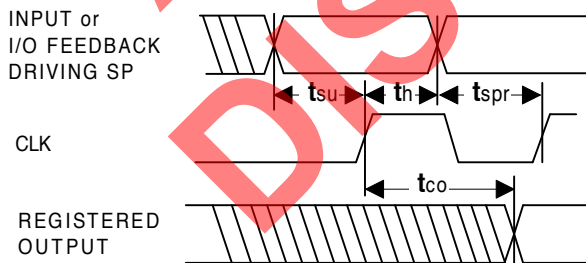

Synchronous Preset

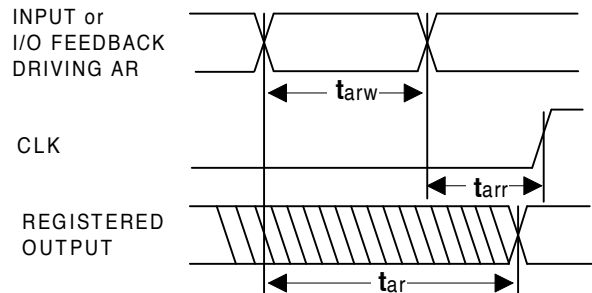

Asynchronous Reset

f_{max} Descriptions

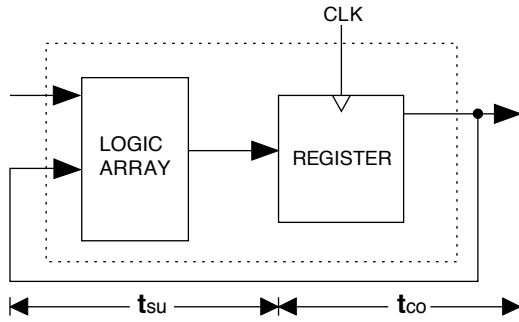

f_{max} with External Feedback 1/(t_{su}+t_{co})

Note: f_{max} with external feedback is calculated from measured t_{su} and t_{co}.

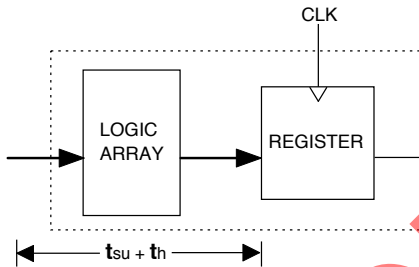

f_{max} with No Feedback

Note: f_{max} with no feedback may be less than 1/(t_{wh} + t_{wl}). This is to allow for a clock duty cycle of other than 50%.

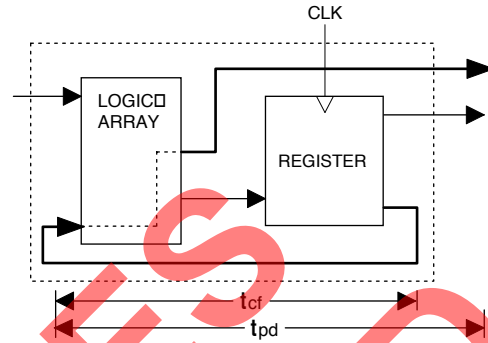

f_{max} with Internal Feedback 1/(t_{su}+t_{cf})

Note: t_{cf} is a calculated value, derived by subtracting t_{su} from the period of f_{max} w/ internal feedback (t_{cf} = 1/f_{max} - t_{su}). The value of t_{cf} is used primarily when calculating the delay from clocking a register to a combinational output (through registered feedback), as shown above. For example, the timing from clock to a combinational output is equal to t_{cf} + t_{pd}.

Switching Test Conditions

Input Pulse Levels	GND to 3.0V	
Input Rise and Fall Times	-7/-10	2ns 10% – 90%
	-15/-20	3ns 10% – 90%
Input Timing Reference Levels	1.5V	
Output Timing Reference Levels	1.5V	
Output Load	See Figure	

3-state levels are measured 0.5V from steady-state active level.

Output Load Conditions (see figure)

Test Condition	R ₁	R ₂	C _L
A	300Ω	390Ω	50pF
B	Active High	∞	390Ω
	Active Low	300Ω	390Ω
C	Active High	∞	5pF
	Active Low	300Ω	390Ω

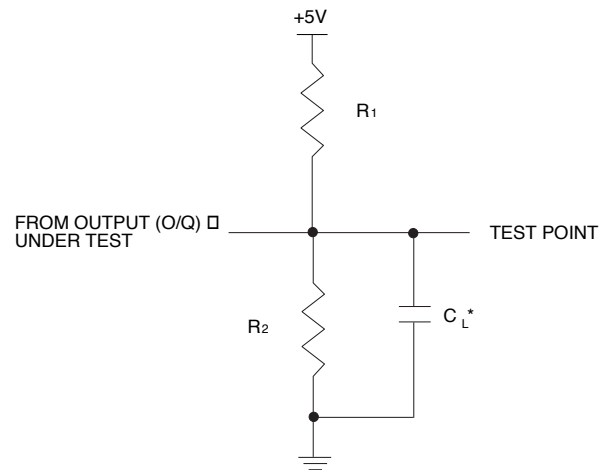

*C_L INCLUDES TEST FIXTURE AND PROBE CAPACITANCE

Electronic Signature

An electronic signature is provided in every GAL18V10 device. It contains 64 bits of reprogrammable memory that can contain user-defined data. Some uses include user ID codes, revision numbers, or inventory control. The signature data is always available to the user independent of the state of the security cell.

Security Cell

A security cell is provided in every GAL18V10 device to prevent unauthorized copying of the array patterns. Once programmed, this cell prevents further read access to the functional bits in the device. This cell can only be erased by re-programming the device, so the original configuration can never be examined once this cell is programmed. The Electronic Signature is always available to the user, regardless of the state of this control cell.

Latch-Up Protection

GAL18V10 devices are designed with an on-board charge pump to negatively bias the substrate. The negative bias is of sufficient magnitude to prevent input undershoots from causing the circuitry to latch. Additionally, outputs are designed with n-channel pullups instead of the traditional p-channel pullups to eliminate any possibility of SCR induced latching.

Device Programming

GAL devices are programmed using a Lattice Semiconductor-approved Logic Programmer, available from a number of manufacturers (see the GAL Development Tools section). Complete programming of the device takes only a few seconds. Erasing of the device is transparent to the user, and is done automatically as part of the programming cycle.

Output Register Preload

When testing state machine designs, all possible states and state transitions must be verified in the design, not just those required in the normal machine operations. This is because certain events may occur during system operation that throw the logic into an illegal state (power-up, line voltage glitches, brown-outs, etc.). To test a design for proper treatment of these conditions, a way must be provided to break the feedback paths, and force any desired (i.e., illegal) state into the registers. Then the machine can be sequenced and the outputs tested for correct next state conditions.

The GAL18V10 device includes circuitry that allows each registered output to be synchronously set either high or low. Thus, any present state condition can be forced for test sequencing. If necessary, approved GAL programmers capable of executing test vectors perform output register preload automatically.

Input Buffers

GAL18V10 devices are designed with TTL level compatible input buffers. These buffers have a characteristically high impedance, and present a much lighter load to the driving logic than bipolar TTL devices.

The input and I/O pins also have built-in active pull-ups. As a result, floating inputs will float to a TTL high (logic 1). However, Lattice Semiconductor recommends that all unused inputs and tri-stated I/O pins be connected to an adjacent active input, Vcc, or ground. Doing so will tend to improve noise immunity and reduce Icc for the device.

Typical Input Current

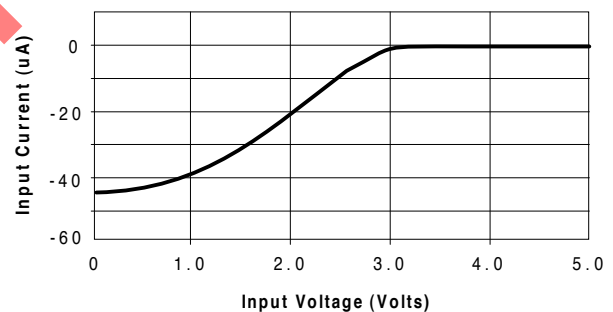

Power-Up Reset

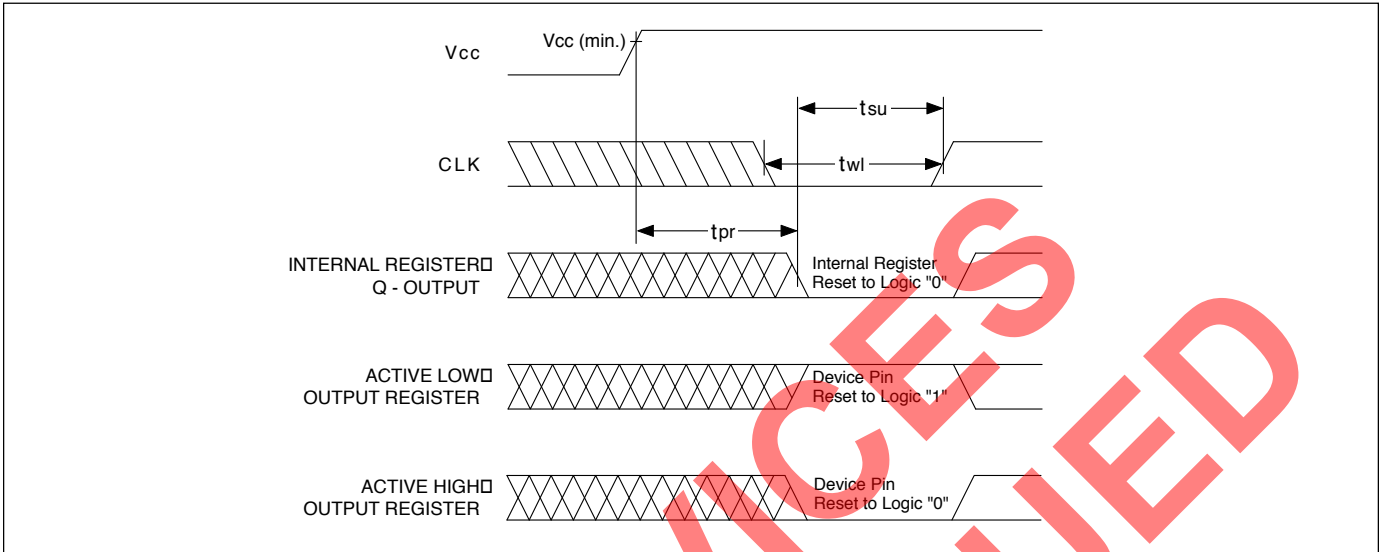

Circuitry within the GAL18V10 provides a reset signal to all registers during power-up. All internal registers will have their Q outputs set low after a specified time (t_{pr} , 1 μs MAX). As a result, the state on the registered output pins (if they are enabled) will be either high or low on power-up, depending on the programmed polarity of the output pins. This feature can greatly simplify state machine design by providing a known state on power-up. Because of the asynchronous nature of system power-up, some

conditions must be met to provide a valid power-up reset of the device. First, the V_{cc} rise must be monotonic. Second, the clock input must be at static TTL level as shown in the diagram during power up. The registers will reset within a maximum of t_{pr} time. As in normal system operation, avoid clocking the device until all input and feedback path setup times have been met. The clock must also meet the minimum pulse width requirements.

Input/Output Equivalent Schematics

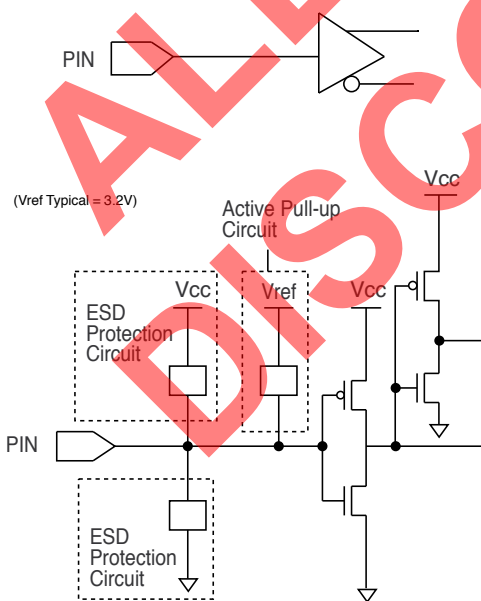

Typical Input

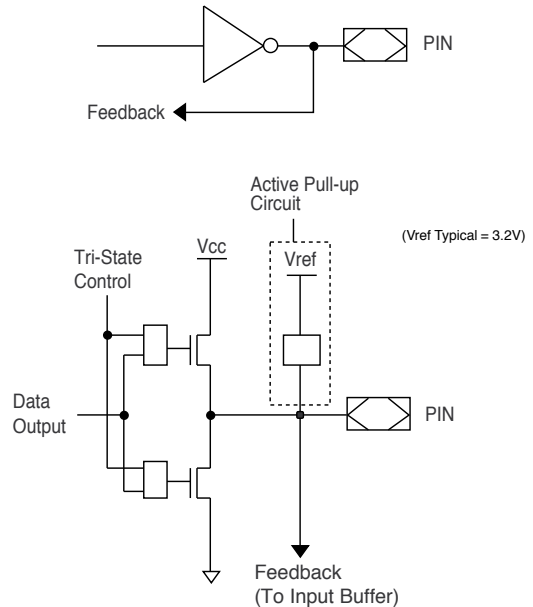

Typical Output

GAL18V10B: Typical AC and DC Characteristic Diagrams

Normalized Tpd vs Vcc

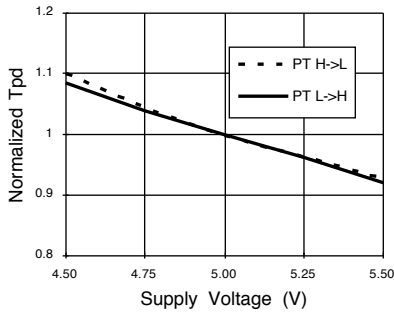

Normalized Tco vs Vcc

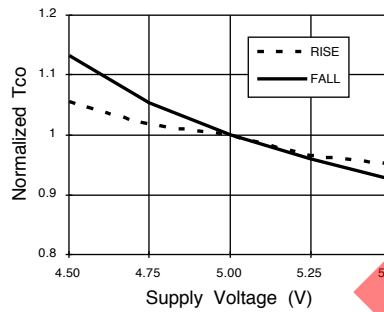

Normalized Tsu vs Vcc

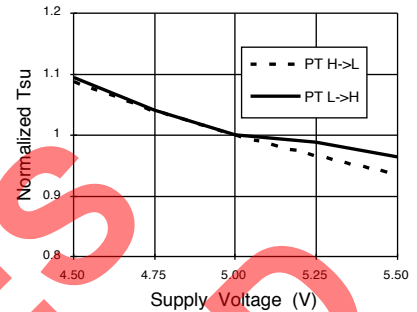

Normalized Tpd vs Temp

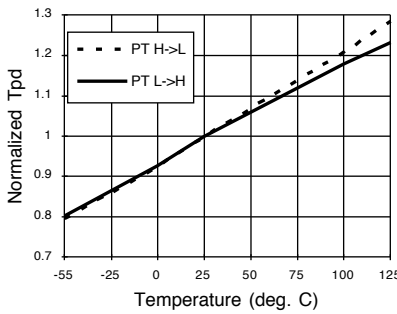

Normalized Tco vs Temp

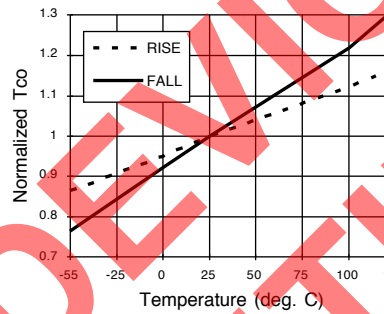

Normalized Tsu vs Temp

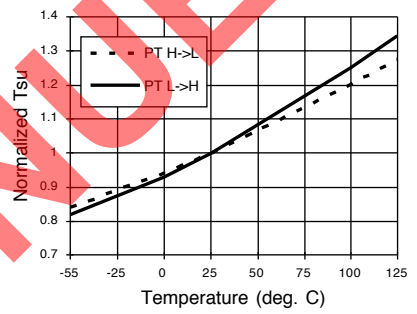

Delta Tpd vs # of Outputs Switching

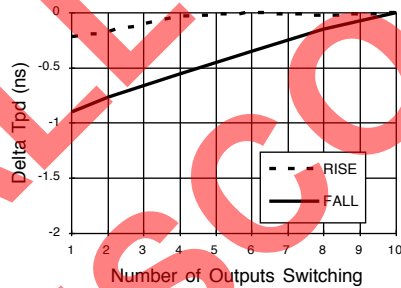

Delta Tco vs # of Outputs Switching

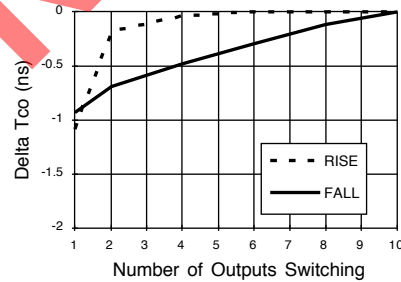

Delta Tpd vs Output Loading

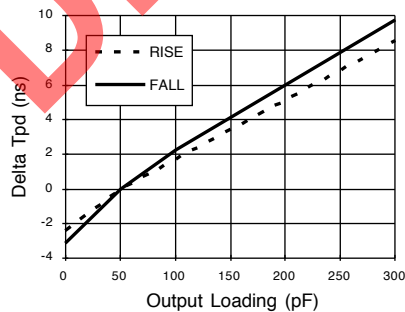

Delta Tco vs Output Loading

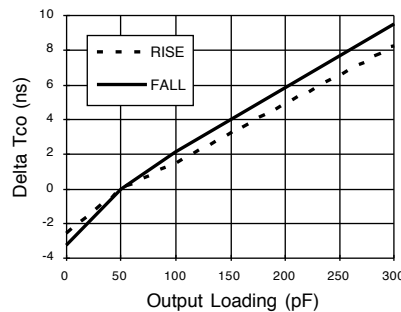

GAL18V10B: Typical AC and DC Characteristic Diagrams

Vol vs Iol

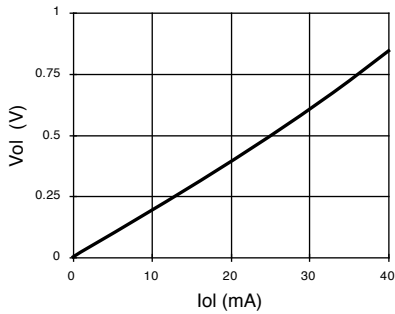

Voh vs Ioh

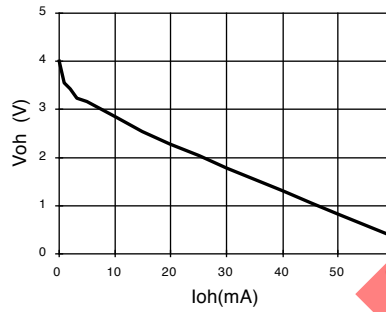

Voh vs Ioh

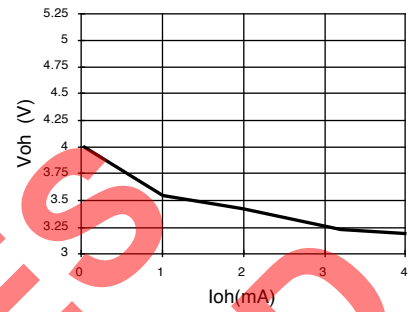

Normalized Icc vs Vcc

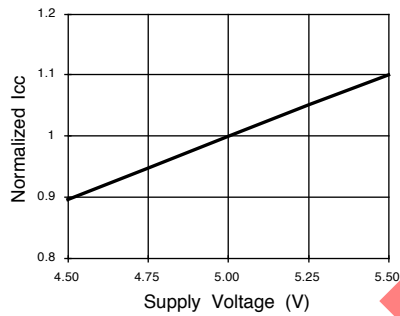

Normalized Icc vs Temp

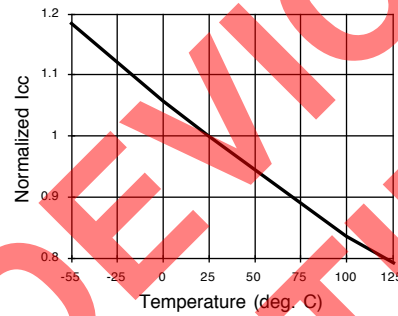

Normalized Icc vs Freq.

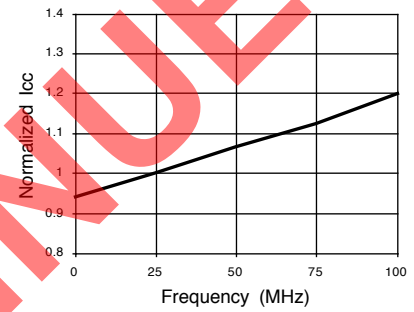

Delta Icc vs Vin (1 input)

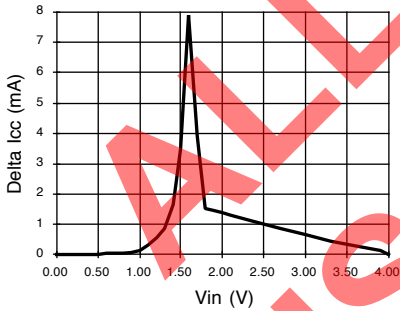

Input Clamp (Iik)

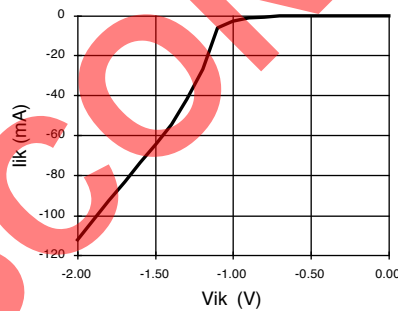

GAL18V10B: Typical AC and DC Characteristic Diagrams

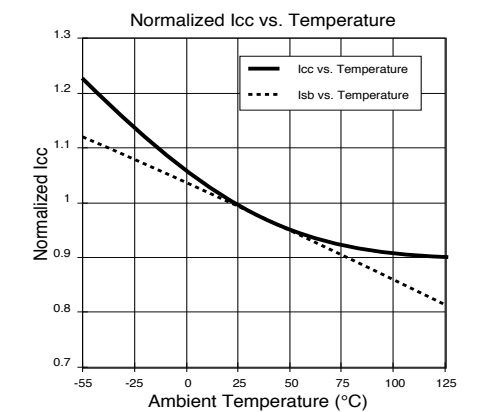
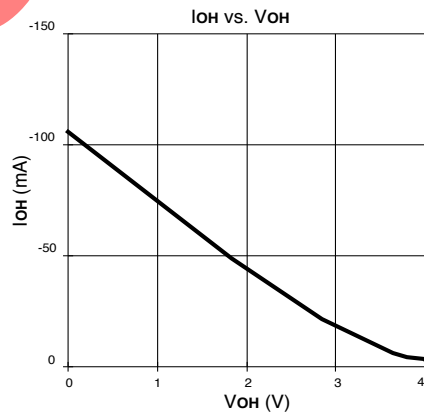
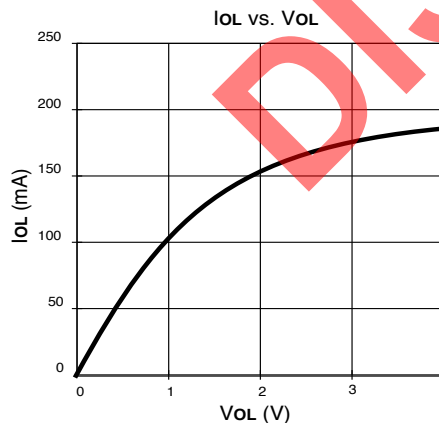
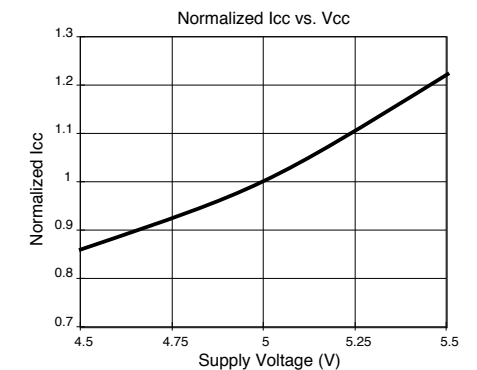
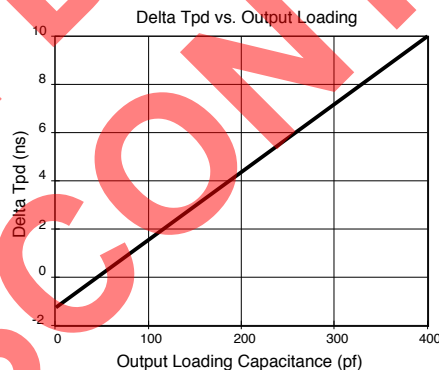
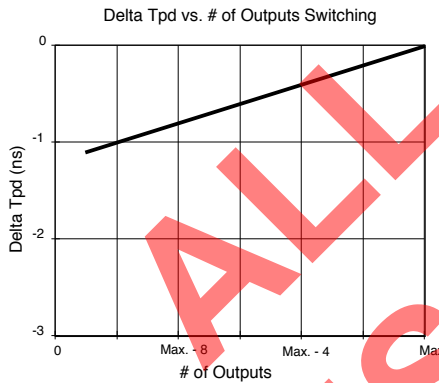
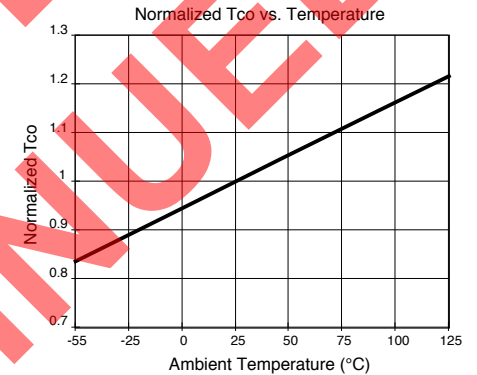
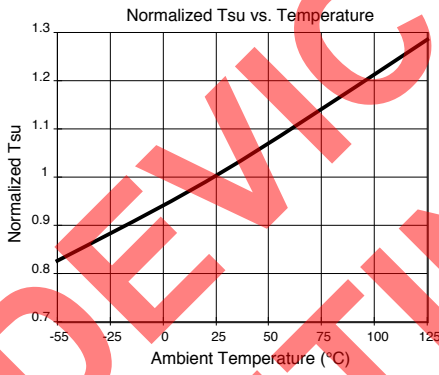
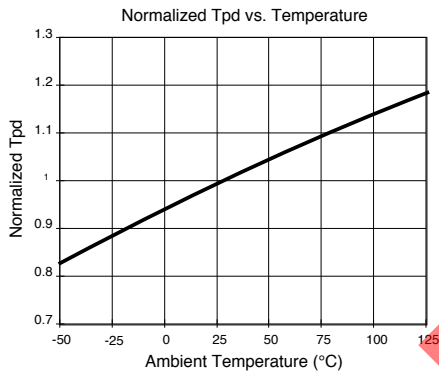
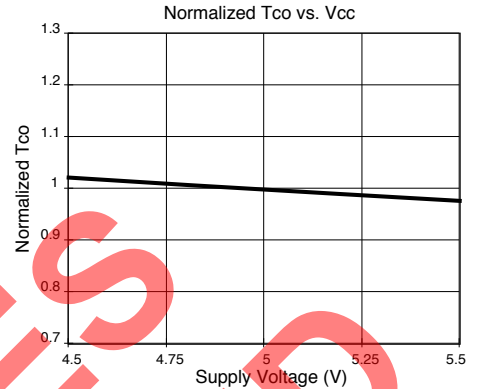
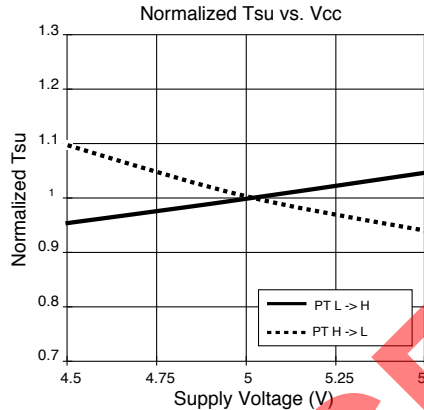
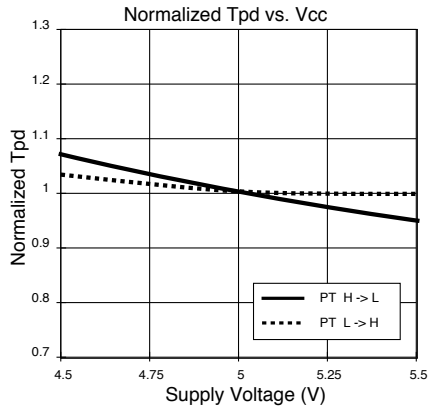

Looking for pricing, stock, or lifecycle information?

Click below to explore more details on WIN SOURCE:

- ⊖ [View GAL18V10B-20LJ on WIN SOURCE](#)
- ⊖ [Lattice Semiconductor Corporation Information](#)

Optimize Your Supply Chain with WIN SOURCE Solutions

- ✓ Global Sourcing Solution
- ✓ Obsolete Management
- ✓ Cost Control Management
- ✓ Shortage Management
- ✓ Alternative Solution
- ✓ Excess Inventory Management