



TDK's New Winding Type Chip Inductor

GLF, GLC Series

TDK Electronics Europe GmbH - September 2004

Copyright 2004 by TDK Electronics Europe GmbH. All rights reserved.



Item Line-Up

Height[mm]		0.80mm	1.25mm
Area[mm ²]			
1.28mm ²	1.60X0.80	GLF1608Type L:1uH to 22uH Rdc:0.70ohm(10uH) Idc:90mA(10uH)	GLF_Type:Low Rdc GLF_Type:Low PPr GLC_Type:High Ioc
2.50mm ²	2.00X1.25	GLF201208Type L:1uH to 47uH Rdc:1.10ohm(10uH) Idc:170mA(10uH)	GLF2012Type L:1uH to 100uH Rdc:0.36ohm(10uH) Idc:140mA(10uH)
4.50mm ²	2.50X1.80		GLF251812Type L:1uH to 100uH Rdc:0.60ohm(10uH) Idc:325mA(10uH)
			GLF2 L:1uH Rdc:0 Idc:21 GLC2 L:1uH Rdc:0 Idc:30



Shapes and Dimensions



	L [mm] ± 0.10	W [mm] ± 0.10	H [mm] ± 0.10	B1 [mm] ± 0.15	B2 [mm] ± 0.15
GLF1608Type	1.60	0.80	0.80	0.40	0.40
GLF2012Type	2.00	1.25	1.25	0.50	0.50
GLF2518Type	2.50	1.80	1.80	0.60	0.60
GLF201208Type	2.00	1.25	0.80	0.45	0.45
GLF251812Type	2.50	1.80	1.25	0.50	0.50
GLC2518Type	2.50	1.80	1.80	0.60	0.60



Electrical Characteristics [GLF1608Type]

ITEM	Inductance & Tolerance	Rdc[ohm]	Idc[mA]	
			L:10%Down Max.	L:20%Down Max.
GLF1608T1R0M	1.0 μ H \pm 20%	\pm 30% 0.17	125	220
GLF1608T2R2M	2.2 μ H \pm 20%	0.33	85	160
GLF1608T4R7M	4.7 μ H \pm 20%	0.55	70	115
GLF1608T100M	10 μ H \pm 20%	0.70	50	90
GLF1608T220M	22 μ H \pm 20%	3.00	35	60



Electrical Characteristics [GLF2012Type]

ITEM	Inductance & Tolerance	Rdc[ohm]	Idc[mA]	
			L:10%Down Max.	L:20%Down Max.
GLF2012T1R0M	1.0μH±20%	±30% 0.07	275	400
GLF2012T2R2M	2.2μH±20%	0.10	210	300
GLF2012T4R7M	4.7μH±20%	0.24	120	200
GLF2012T100K	10μH±10%	0.36	100	140
GLF2012T220K	22μH±10%	1.00	75	100
GLF2012T470K	47μH±10%	1.70	50	75
GLF2012T101K	100μH±10%	4.00	30	50



Electrical Characteristics [GLF2518Type]

ITEM	Inductance & Tolerance	Rdc[ohm]	Idc[mA]	
			L:10%Down Max.	L:20%Down Max.
GLF2518T1R0M	1.0μH±20%	0.05±30%	500	675
GLF2518T2R2M	2.2μH±20%	0.08±30%	340	450
GLF2518T4R7M	4.7μH±20%	0.11±30%	240	320
GLF2518T100K	10μH±10%	0.20±20%	165	210
GLF2518T220K	22μH±10%	0.45±20%	115	150
GLF2518T470K	47μH±10%	0.85±20%	85	100
GLF2518T101K	100μH±10%	1.90±20%	55	75



Electrical Characteristics [GLF201208Type]

ITEM	Inductance & Tolerance	Rdc[ohm]	Idc[mA]	
			L:10%Down Max.	L:20%Down Max.
GLF201208T1R0M	1.0μH±20%	0.19±20%	340	460
GLF201208T2R2M	2.2μH±20%	0.56±20%	220	300
GLF201208T4R7M	4.7μH±20%	0.74±20%	160	230
GLF201208T100M	10μH±20%	1.10±20%	130	170
GLF201208T220M	22μH±20%	3.50±20%	80	110
GLF201208T470M	47μH±20%	5.30±20%	60	90



Electrical Characteristics [GLF251812Type]

ITEM	Inductance & Tolerance	Rdc[ohm]	Idc[mA]	
			L:10%Down Max.	L:20%Down Max.
GLF251812T1R0M	1.0μH±20%	0.10±20%	650	800
GLF251812T2R2M	2.2μH±20%	0.20±20%	450	600
GLF251812T4R7M	4.7μH±20%	0.38±20%	275	450
GLF251812T100M	10μH±20%	0.60±20%	200	325
GLF251812T220M	22μH±20%	1.20±20%	140	250
GLF251812T470M	47μH±20%	2.50±20%	100	175
GLF251812T101M	100μH±20%	4.70±20%	80	125



Electrical Characteristics [GLC2518Type]

ITEM	Inductance & Tolerance	Rdc[ohm]	Idc[mA]	
			L:10%Down Max.	L:20%Do Max.
GLC2518T1R0M	1.0μH±20%	0.08±30%	850	-----
GLC2518T2R2M	2.2μH±20%	0.13±30%	650	-----
GLC2518T4R7M	4.7μH±20%	0.20±30%	475	-----
GLC2518T100K	10μH±10%	0.36±20%	350	-----
GLC2518T220K	22μH±10%	0.90±20%	225	-----
GLC2518T470K	47μH±10%	1.90±20%	170	-----
GLC2518T101K	100μH±10%	3.50±20%	110	-----



Typical Electrical Characteristics [GLF1608Type]

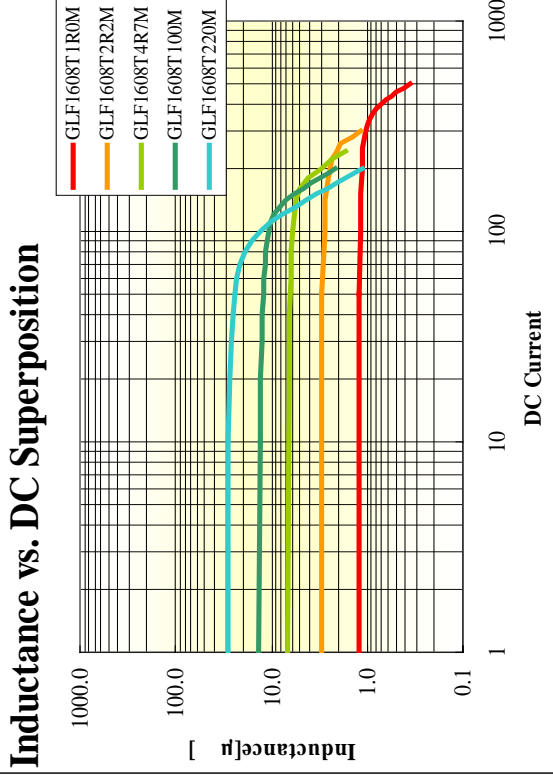
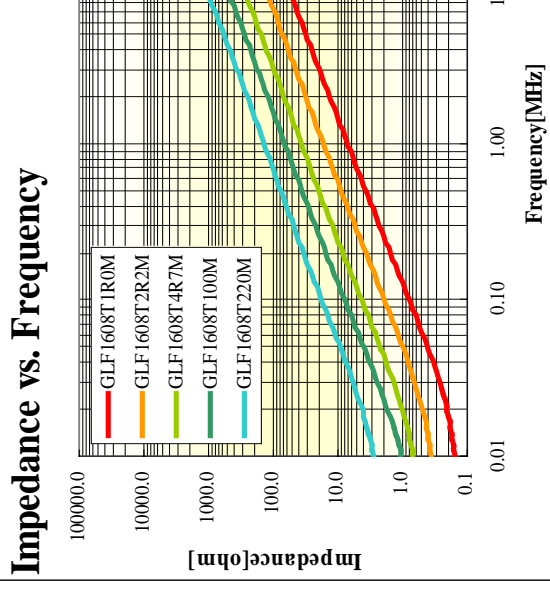
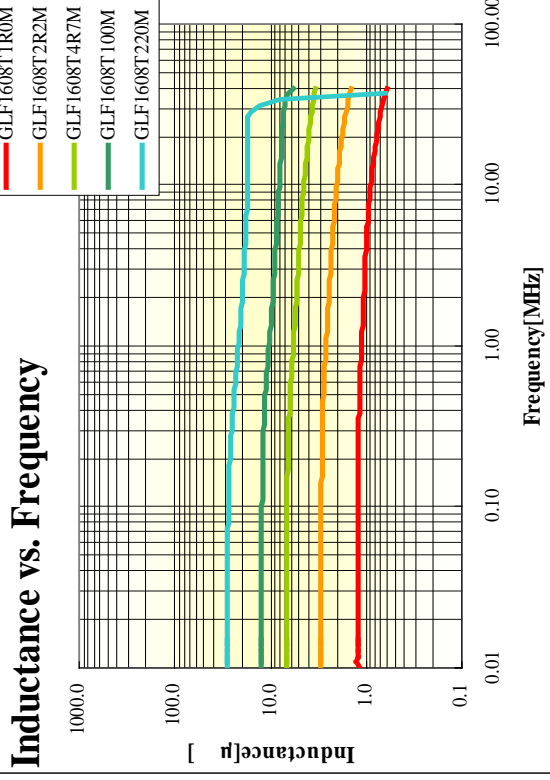



Typical Electrical Characteristics [GLF2012Type]

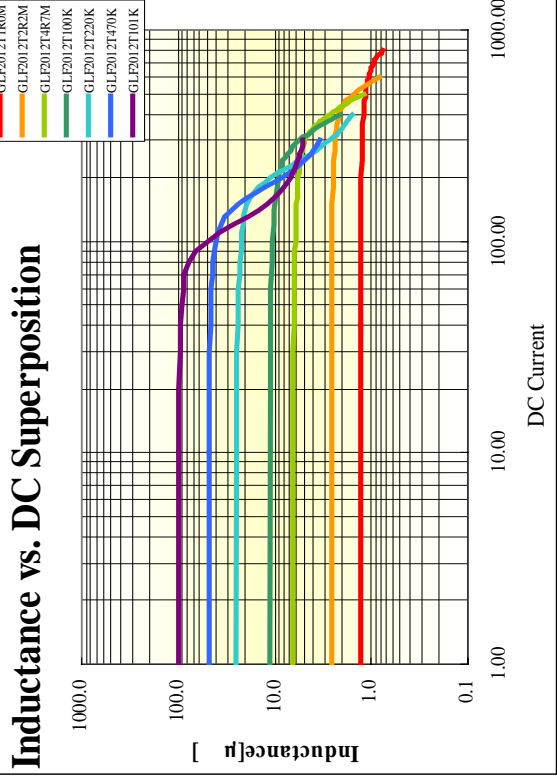
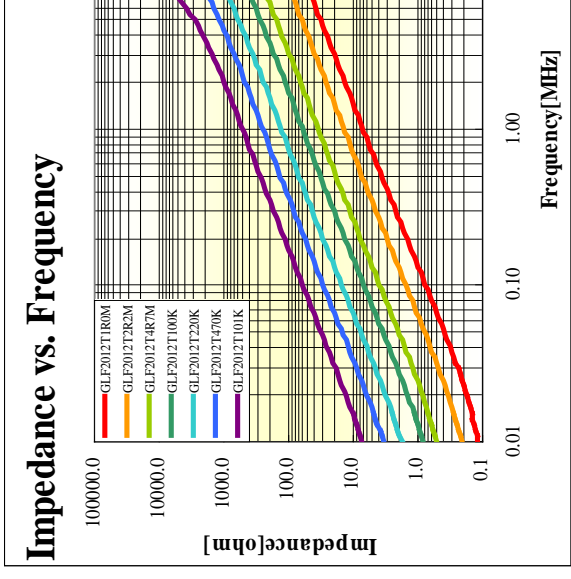
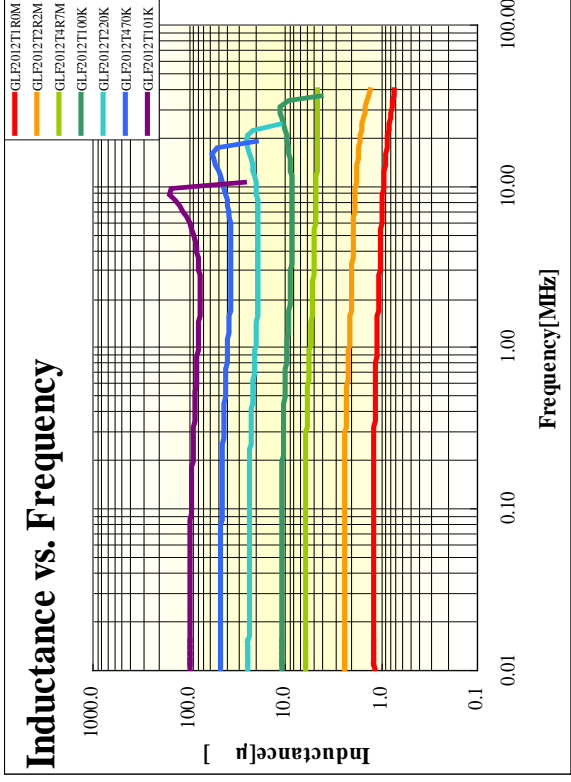



Typical Electrical Characteristics [GLF2518Type]

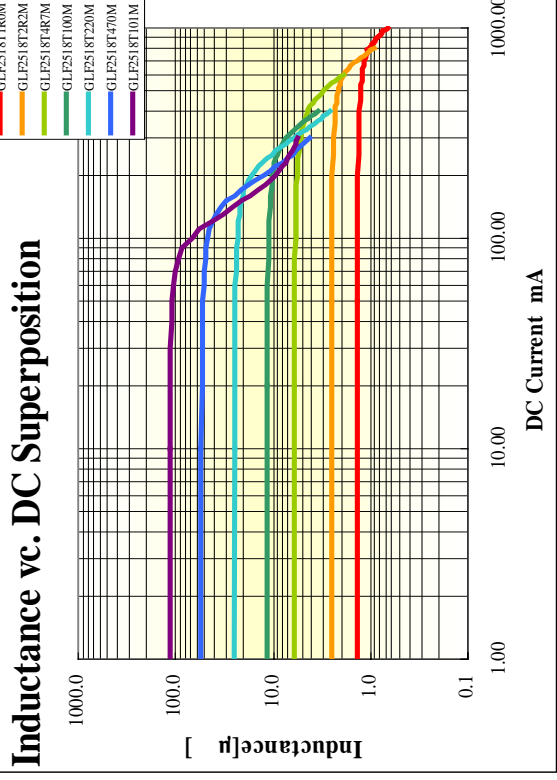
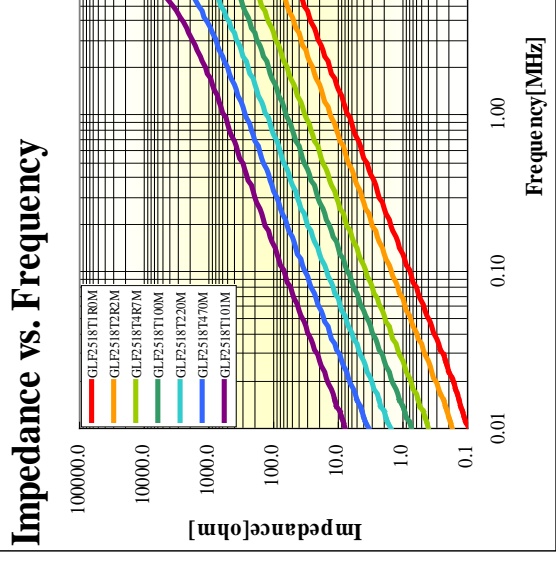
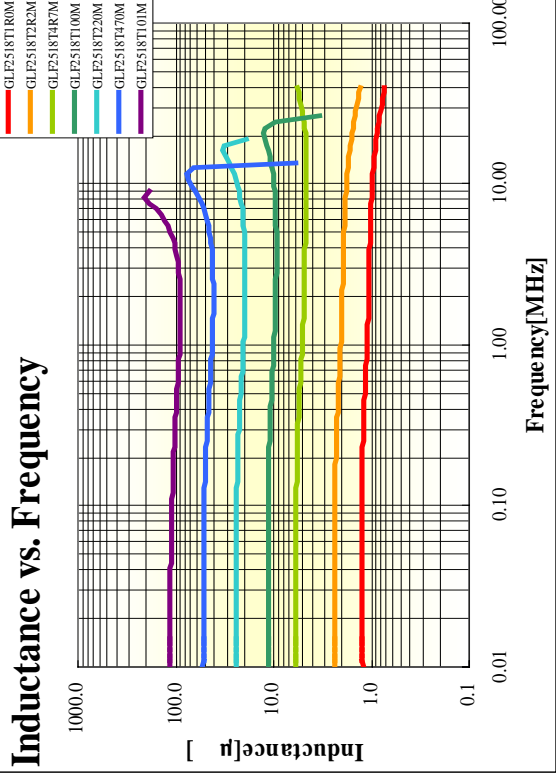



Typical Electrical Characteristics [GLF201208Type]

Inductance vs. Frequency

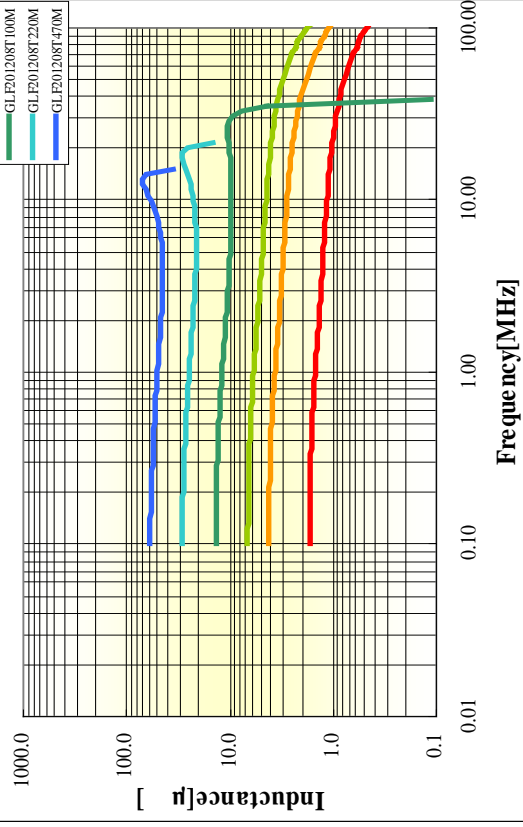

Impedance vs. Frequency

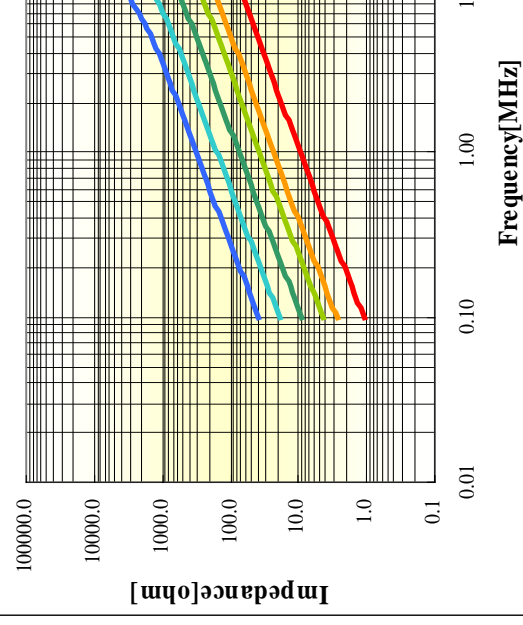

Inductance vs. DC Superposition

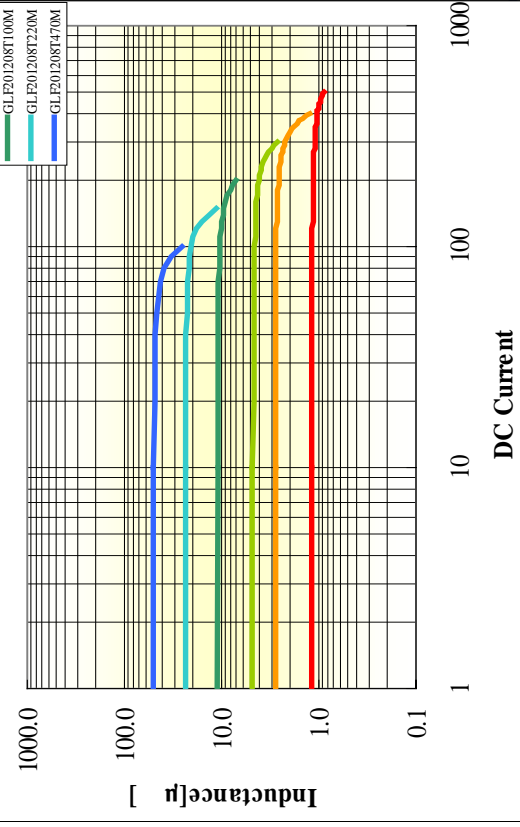



Typical Electrical Characteristics [GLF251812Type]

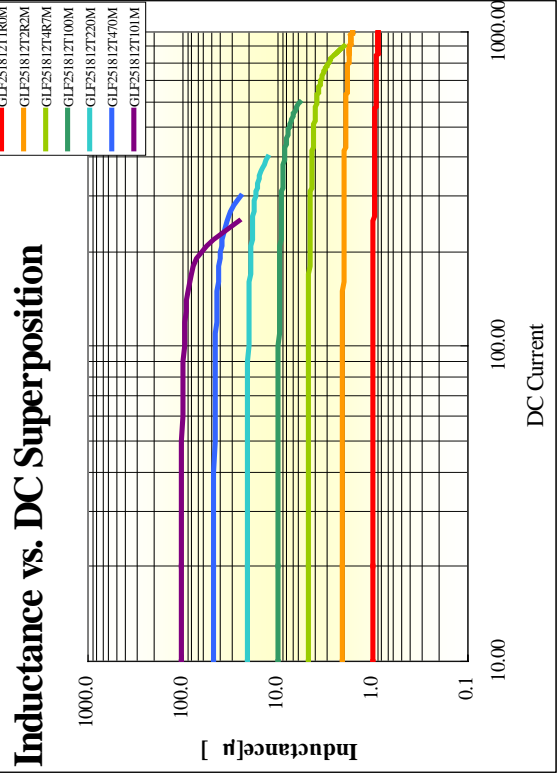
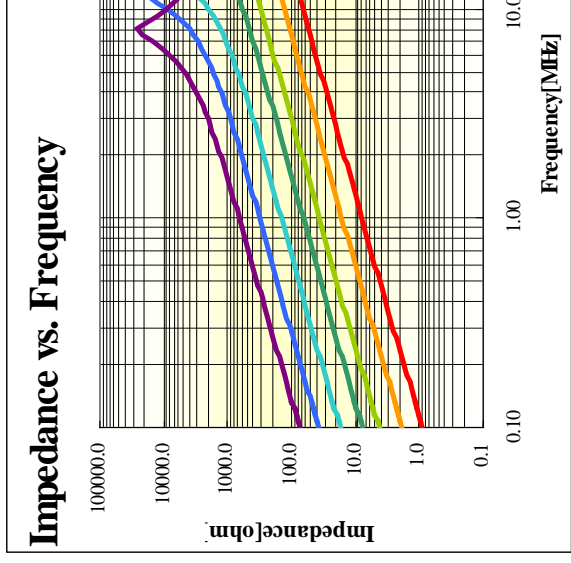
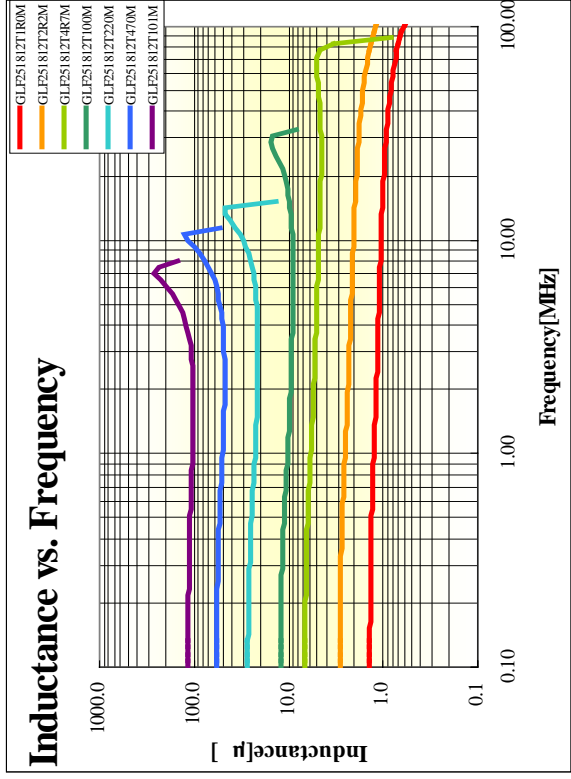



Typical Electrical Characteristics [GLC2518Type]

Inductance vs. Frequency

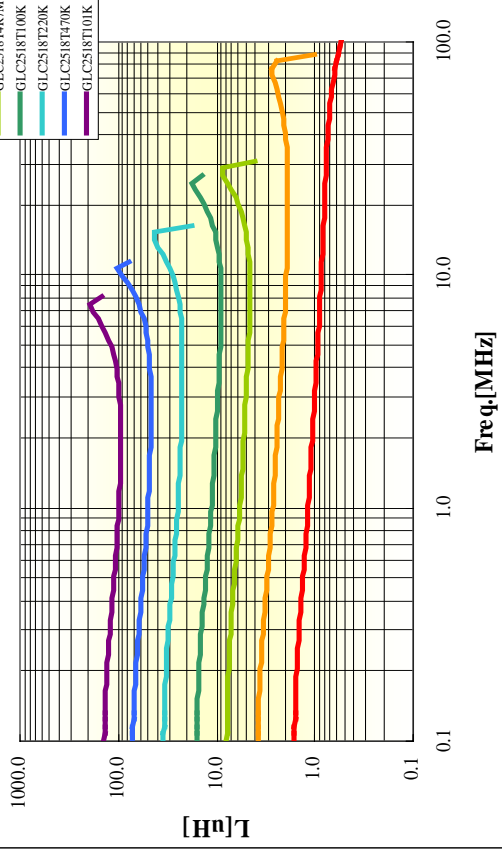

Impedance vs. Frequency

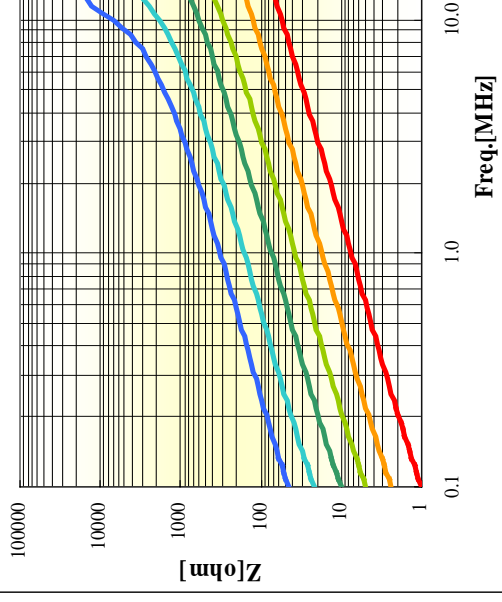

Inductance vs. DC Superposition

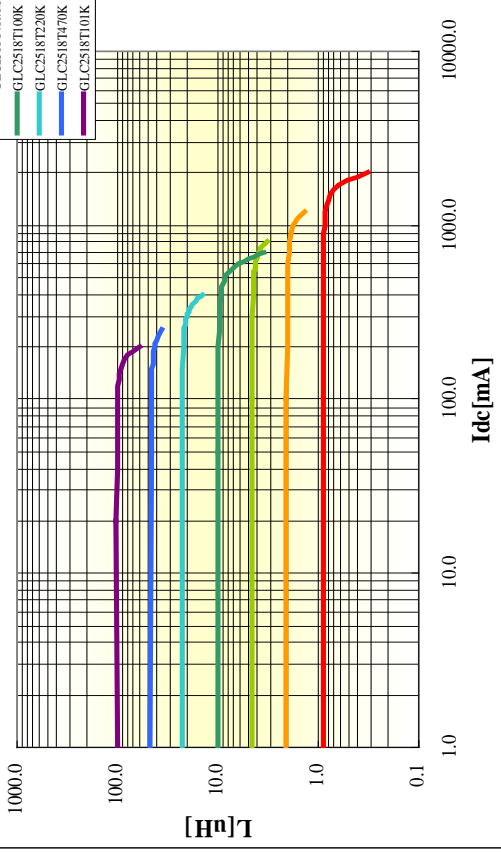



GLF & GLC Series Basic Information

Ratings

Temperature rise: 20C° max.

Storage temperature range: -40C° to 105C°

Operating temperature range: -20C° to 105C°

Country of origin

Japan

(TDK Shonai Manufacturing Corporation/Yamagata)



The Recommended Land Pattern

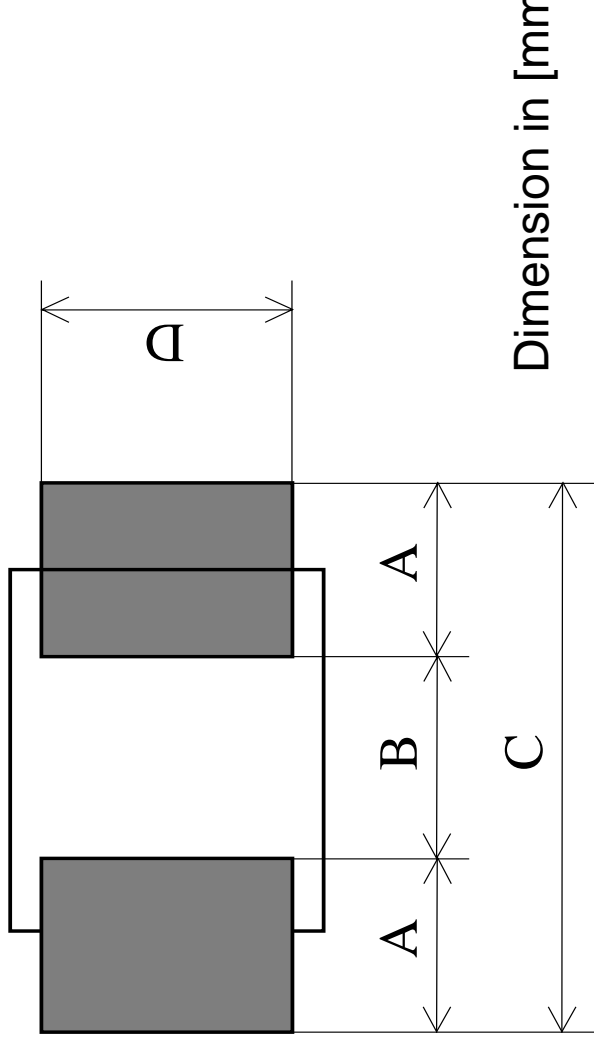

	A [mm]	B [mm]	C [mm]	D [mm]
GLF1608Type	0.70	0.70	2.10	0.70
GLF2012Type	0.80	1.00	2.60	0.80
GLF201208Type				
GLF2518Type				
GLF251812Type	0.90	1.30	3.10	1.60
GLC2518Type				



Reliability requirements

Test Item	Test Condition	Specification	T				
Temperature characteristics	The test shall be performed after the sample has stabilized in an ambient temperature of -40 to +105 ,and the value calculated based on the value applicable in a normal temperature of +20 .	L ₂₀ ±10%	<table border="1"> <tr><td>L</td></tr> <tr><td>Avg.</td></tr> <tr><td>Max.</td></tr> <tr><td>Min.</td></tr> </table>	L	Avg.	Max.	Min.
L							
Avg.							
Max.							
Min.							
Thermal shock	<p>The test shall be performed upon completion of 100 cycles in accordance with the conditions in the figure below , the measurement shall be made after the sample has been left in a normal temperature and normal humidity more than 12hours.</p>	No mechanical damage. L/Lo ±10%	<table border="1"> <tr><td>L</td></tr> <tr><td>Avg.</td></tr> <tr><td>Max.</td></tr> <tr><td>Min.</td></tr> </table>	L	Avg.	Max.	Min.
L							
Avg.							
Max.							
Min.							
Low temperature storage	This test shall be performed upon completion of 1000±12hours in an atmosphere with a temperature of -40±2 Upon completion of the test, the measurement shall be made after The sample has been left in a normal temperature and normal humidity more than 12hours.	No mechanical damage. L/Lo ±10%	<table border="1"> <tr><td>L</td></tr> <tr><td>Avg.</td></tr> <tr><td>Max.</td></tr> <tr><td>Min.</td></tr> </table>	L	Avg.	Max.	Min.
L							
Avg.							
Max.							
Min.							
Continuous operation in high temperature	The sample shall be left for 1000±12hours in an atmosphere with a temperature of +105±2 , under supplying rated current.Upon completion of the test, the measurement shall be made after the sample has been left in a normal temperature and normal humidity more than 12hours.	No mechanical damage. L/Lo ±10%	<table border="1"> <tr><td>L</td></tr> <tr><td>Avg.</td></tr> <tr><td>Max.</td></tr> <tr><td>Min.</td></tr> </table>	L	Avg.	Max.	Min.
L							
Avg.							
Max.							
Min.							
Continuous operation in moisture	The sample shall be left for 1000±12hours in an atmosphere with a temperature of +60±3 and a humidity(RH)of 90-95%,under supplying rated current.Upon completion of the test,the measurement shall be made after the sample has been left in a normal temperature and normal humidity more than 12hours.	No mechanical damage. L/Lo ±10%	<table border="1"> <tr><td>L</td></tr> <tr><td>Avg.</td></tr> <tr><td>Max.</td></tr> <tr><td>Min.</td></tr> </table>	L	Avg.	Max.	Min.
L							
Avg.							
Max.							
Min.							



Recommended Soldering Conditions

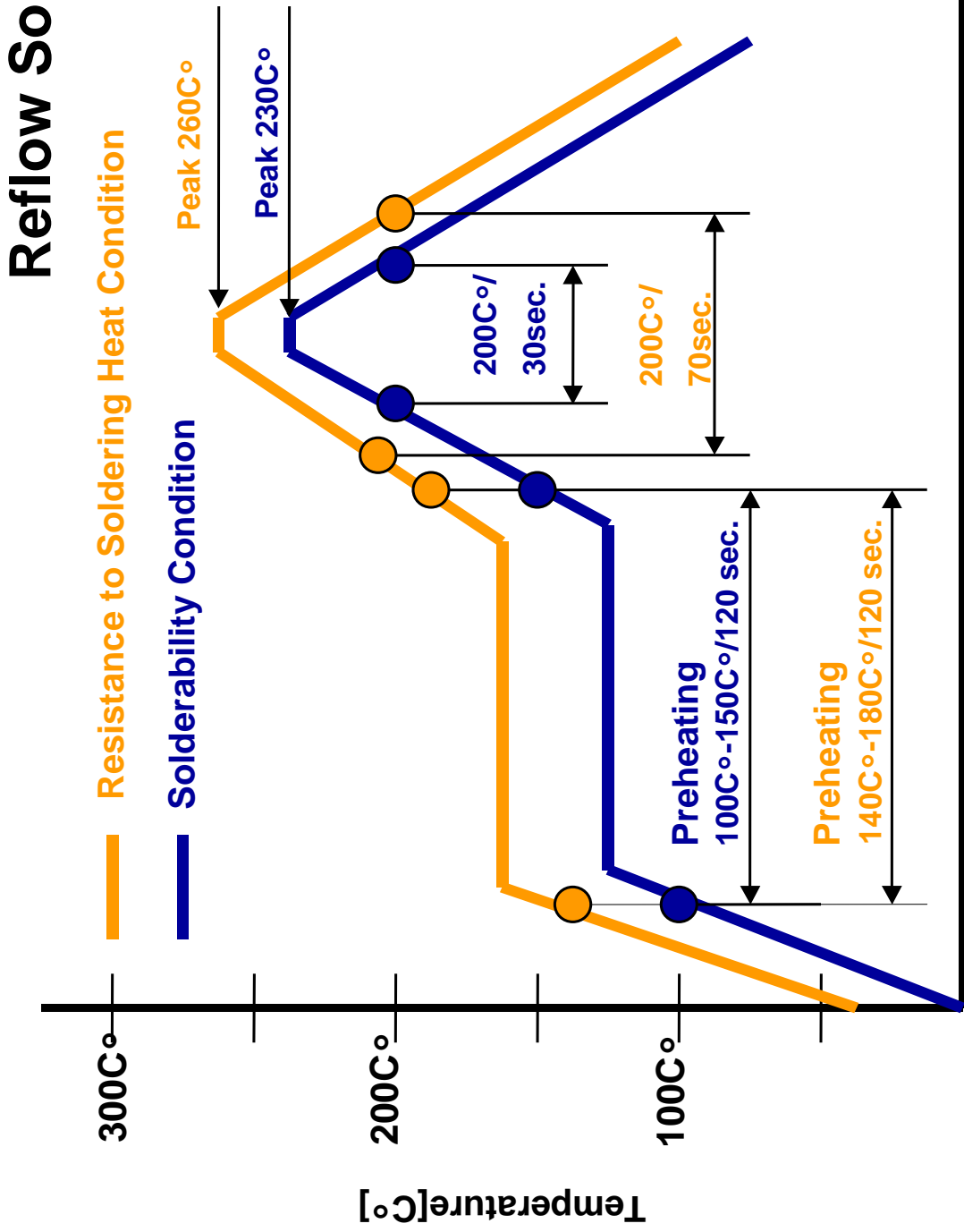



Technical Part and Leader Part Tape

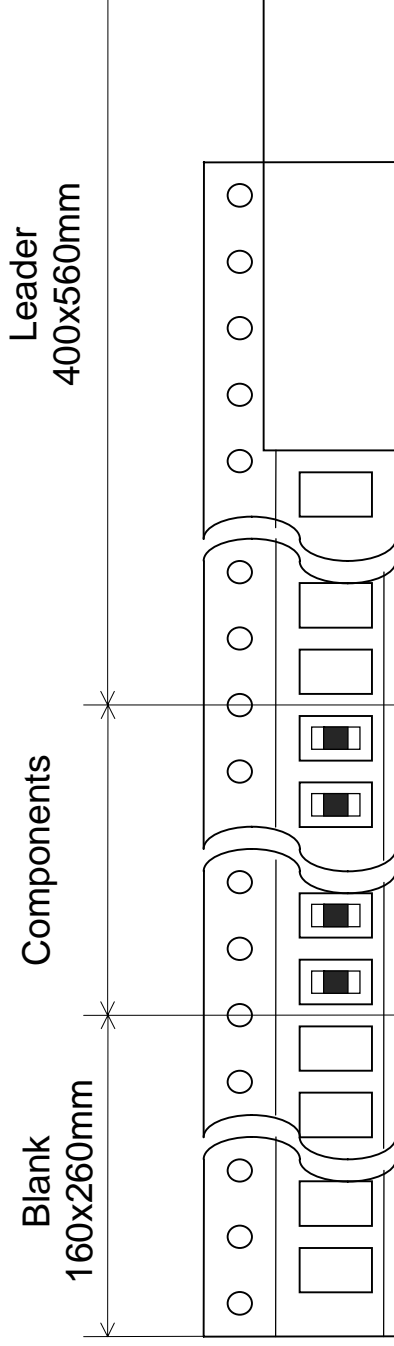

	Packing number
GLF1608Type	4,000pieces
GLF201208Type	2,000pieces
GLF2012Type	
GLF2518Type	
GLF251812Type	
GLC2518Type	

Reel Dimension

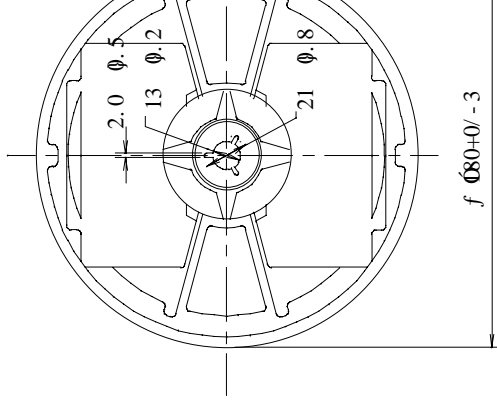

Looking for pricing, stock, or lifecycle information?

Click below to explore more details on WIN SOURCE:

 [View GLF2012T220K on WIN SOURCE](#)

 [TDK Corporation Information](#)

Optimize Your Supply Chain with WIN SOURCE Solutions

-  Global Sourcing Solution
-  Obsolete Management
-  Cost Control Management
-  Shortage Management
-  Alternative Solution
-  Excess Inventory Management