



THE DATASHEET OF H21A3





H21Ax, H22Ax



DESCRIPTION

The H21Ax and H22Ax series of opaque photointerrupters are single channel switches consisting of a Gallium Arsenide infrared emitting diode and a NPN silicon photo transistor mounted in a polycarbonate housing. The package is designed to optimise the mechanical resolution, coupling efficiency, ambient light rejection, cost and reliability.

Operating on the principle that objects opaque to infrared will interrupt the transmission of light between the infrared emitting diode and the photo sensor, switching the output from an "ON" state to an "OFF" state.

These photointerrupters are in PWB mounting packages while H21Ax also provides flanges for Screw Mounting.

FEATURES

- High Gain
- 3mm Gap between LED and Detector
- Polycarbonate Case Protection against Ambient Light
- Pb Free and RoHS Compliant
- Safety Approvals Pending

APPLICATIONS

- Copiers, Printers, Facsimiles
- Record Players, Cassette Decks
- Optoelectronic Switches

ORDER INFORMATION

- Supplied in Bulk Package

Top View

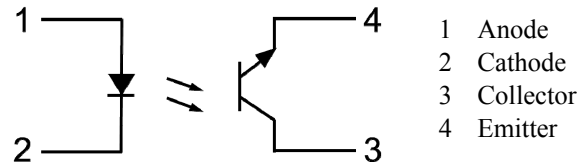

ABSOLUTE MAXIMUM RATINGS (T_A = 25°C)

Stresses exceeding the absolute maximum ratings can cause permanent damage to the device.

Exposure to absolute maximum ratings for long periods of time

Input

Forward Current	50mA
Reverse Voltage	5V
Power dissipation	75mW

Output

Collector Current	20mA
Collector-Emitter Voltage	30V
Emitter-Collector Voltage	5V
Power Dissipation	100mW

Total Package

Operating Temperature	-25 to 85 °C
Storage Temperature	-55 to 100 °C
Lead Soldering Temperature (10s)	260°C

can adversely affect reliability.

ISOCOM COMPONENTS 2004 LTD

Unit 25B, Park View Road West, Park View Industrial Estate
Hartlepool, Cleveland, TS25 1PE, United Kingdom
Tel : +44 (0)1429 863 609 Fax : +44 (0)1429 863 581
e-mail : sales@isocom.co.uk
<http://www.isocom.com>

ISOCOM COMPONENTS ASIA LTD

Hong Kong Office,
Block A, 8/F, Wah Hing Industrial mansion,
36 Tai Yau Street, San Po Kong, Kowloon, Hong Kong.
Tel : +852 2995 9217 Fax : +852 8161 6292
e-mail : sales@isocom.com.hk



H21Ax, H22Ax

ELECTRICAL CHARACTERISTICS ($T_A = 25^\circ\text{C}$ unless otherwise specified)

INPUT

Parameter	Symbol	Test Condition	Min	Typ.	Max	Unit
Forward Voltage	V_F	$I_F = 20\text{mA}$		1.2	1.6	V
Reverse Current	I_R	$V_R = 5\text{V}$			100	μA

OUTPUT

Parameter	Symbol	Test Condition	Min	Typ.	Max	Unit
Collector-Emitter Dark Current	I_{CEO}	$V_{CE} = 10\text{V}$			100	nA

COUPLED

Parameter	Symbol	Test Condition	Min	Typ.	Max	Unit	
On-State Collector Current	$I_{C(ON)}$	H21A1, H22A1				mA	
		$I_F = 5\text{mA}, V_{CE} = 5\text{V}$	0.15				
		$I_F = 20\text{mA}, V_{CE} = 5\text{V}$	1.0				
		$I_F = 30\text{mA}, V_{CE} = 5\text{V}$	1.9				
		H21A2, H22A2					
		$I_F = 5\text{mA}, V_{CE} = 5\text{V}$	0.3				
		$I_F = 20\text{mA}, V_{CE} = 5\text{V}$	2.0				
		$I_F = 30\text{mA}, V_{CE} = 5\text{V}$	3.0				
		H21A3, H22A3					
$I_F = 5\text{mA}, V_{CE} = 5\text{V}$	0.6						
$I_F = 20\text{mA}, V_{CE} = 5\text{V}$	4.0						
$I_F = 30\text{mA}, V_{CE} = 5\text{V}$	5.5						
Collector-Emitter Saturation Voltage	$V_{CE(SAT)}$	$I_F = 20\text{mA}, I_C = 0.25\text{mA}$			0.4	V	

SWITCHING

Parameter	Symbol	Test Condition	Min	Typ.	Max	Unit
Output Rise Time (10% to 90%)	t_r	$V_{CE} = 5\text{V}, I_C = 2\text{mA}$ $R_L = 100\Omega,$		3	15	μs
Output Fall Time (90% to 10%)	t_f			4	20	



H21Ax, H22Ax

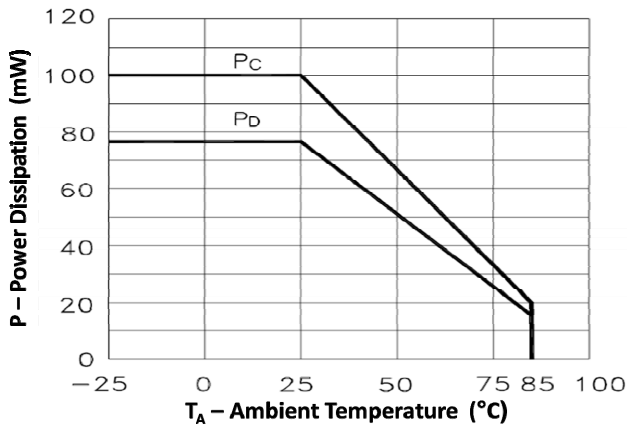

Fig 1 Power Dissipation vs Ambient Temperature

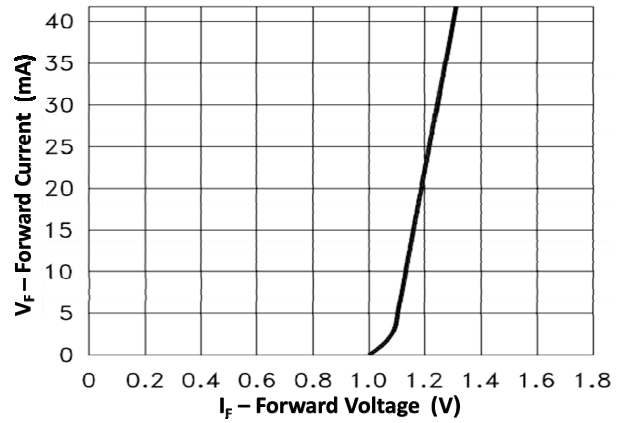

Fig 2 Forward Current vs Forward Voltage

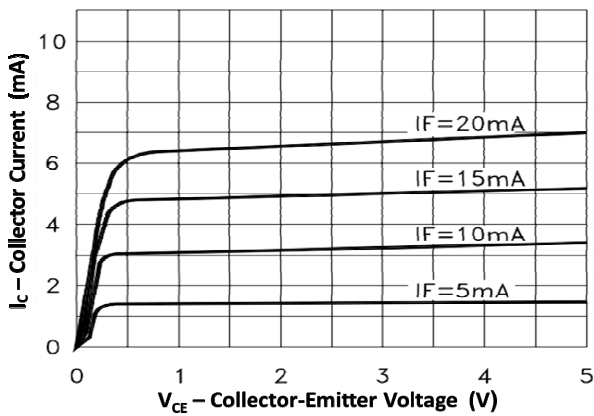

Fig 3 Collector Current vs Collector-Emitter Voltage

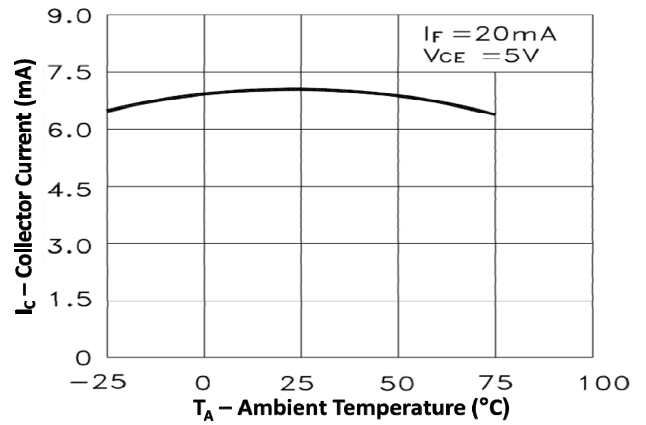

Fig 4 Collector Current vs Ambient Temperature

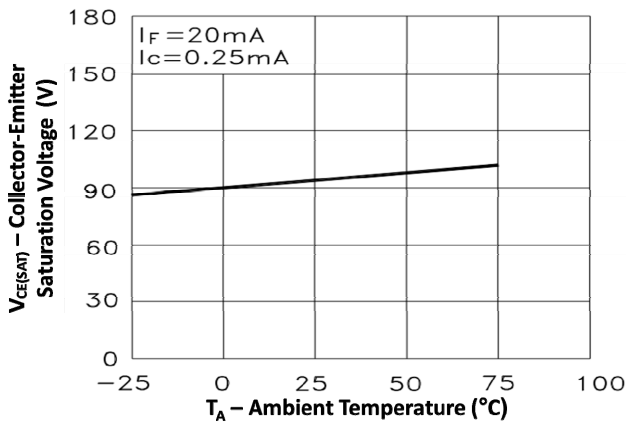

Fig 5 Collector-Emitter Saturation Voltage vs T_A



H21Ax, H22Ax

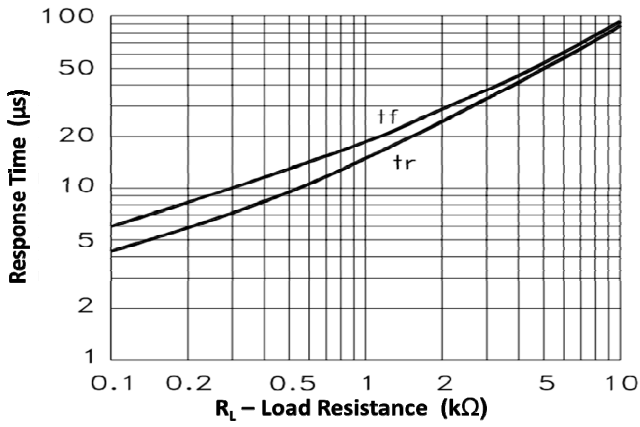
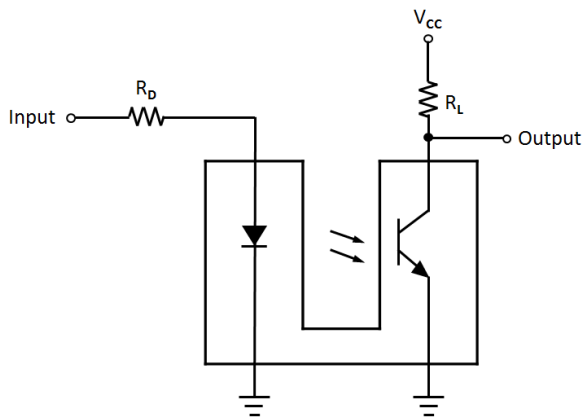
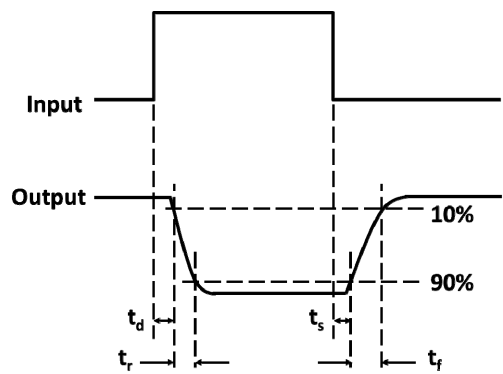

Fig 6 Response Time vs Load Resistance



Test Circuit for Response Time





H21Ax, H22Ax

ORDER INFORMATION

H21Ax, H22Ax			
After PN	PN	Description	Packing quantity
None	H21A1, H21A2, H21A3 H22A1, H22A2, H22A3	Bulk Package	500pcs

DEVICE MARKING

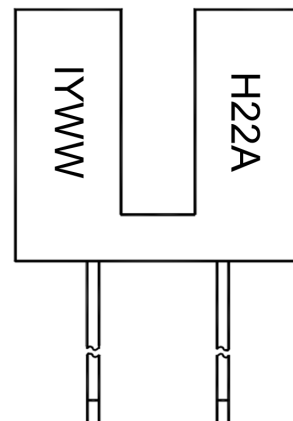
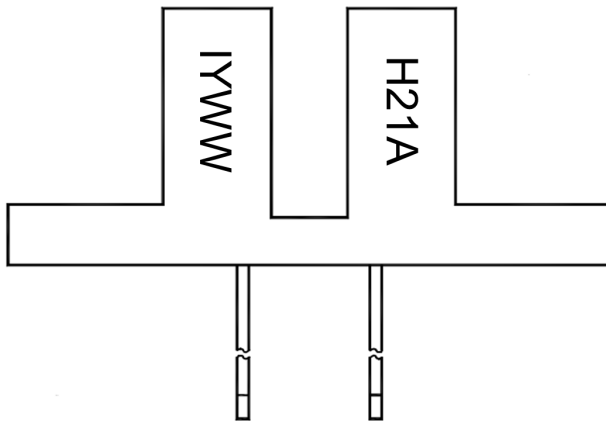

H21A / H22A denotes Device Part Number

I denotes Isocom

Y denotes 1 digit Year code

WW denotes 2 digit Week code

Note : H21A Type will be Marked "H21A"
H22A Type will be Marked "H22A"



H21Ax, H22Ax

PACKAGE DIMENSIONS in inch(mm)

Tolerance : ± 0.010 " (0.25mm) unless otherwise noted.

H21A

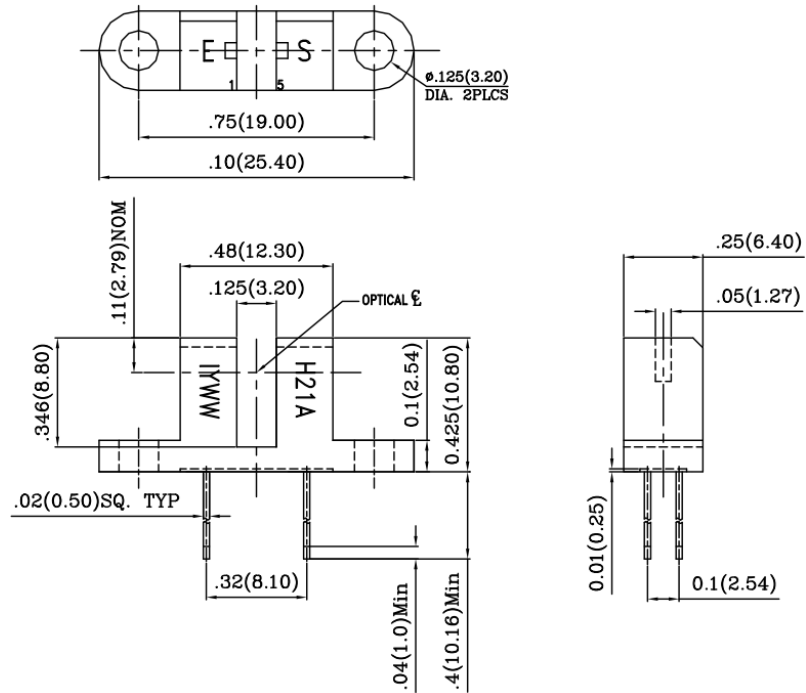

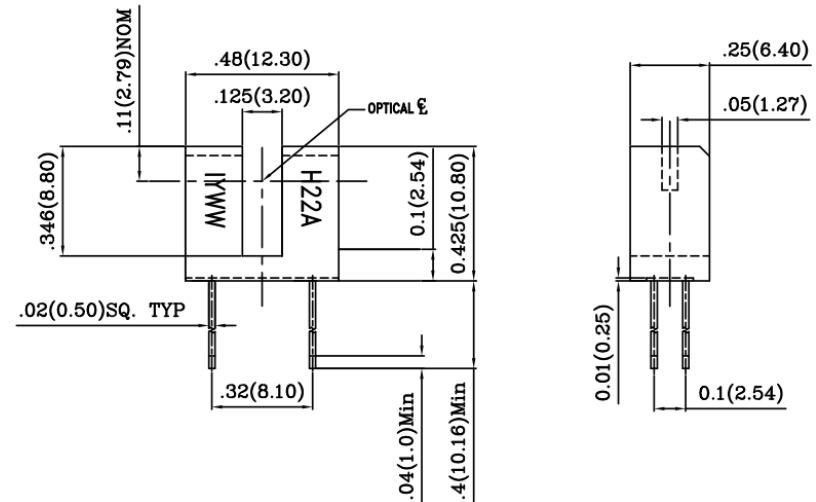

H22A



Looking for pricing, stock, or lifecycle information?

Click below to explore more details on WIN SOURCE:

-  [View H21A3 on WIN SOURCE](#)
-  [Isocom Components 2004 LTD Information](#)

Optimize Your Supply Chain with WIN SOURCE Solutions

-  Global Sourcing Solution
-  Obsolete Management
-  Cost Control Management
-  Shortage Management
-  Alternative Solution
-  Excess Inventory Management