



**Discontinued: Keep type**  
**Last time buy: August 31, 2012**



# Panasonic

ideas for life

Relay for control panel of  
 1A to 10A (1c/2c/3c/4c)

## HC RELAYS

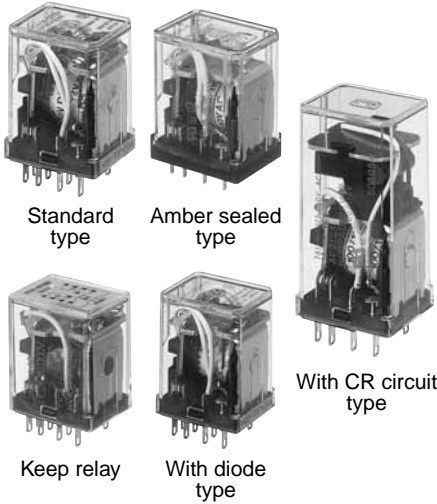

### FEATURES

1. Standard type, Amber sealed type and Keep type
2. Rich lineup includes relays with operating indication, with diode and with CR circuit
3. Full range of types  
 Plug-in type, PC board type and TM type
4. Sockets and terminal sockets are available.

### TYPICAL APPLICATIONS

1. Factory automation equipment and automotive devices
2. Control panels, power supply equipment, molding equipment, machine tools, welding equipment, agricultural equipment, etc.
3. Office equipment, automatic vending machines, telecommunications equipment, disaster prevention equipment, copiers, measuring devices, medical equipment, amusement devices, etc.
4. All types of household appliance

**RoHS compliant**

## ORDERING INFORMATION

HC  -  -  -  -  -

#### Contact arrangement

- 1: 1 Form C
- 2: 2 Form C
- 3: 3 Form C
- 4: 4 Form C
- 4D: Bifurcated contact (twin)

#### Nil: Standard type

- E: Amber sealed type (Only 1 Form C and 2 Form C)
- ED: Amber sealed type bifurcated contact (twin) (Only 4 Form C)
- K: Keep type

#### Terminal arrangement

- H: Plug-in type
- HL: Plug-in with LED indication
- L: Plug-in with LED indication (Amber sealed type)
- HP: PC board type
- PL: PC board with LED indication
- HPL: PC board with LED indication (Amber sealed type)
- HTM: TM type

#### Nominal coil voltage

- AC 6, 12, 24, 48, 100 (100/110), 120 (110/120), 200 (200/220), 240 (220/240) V
- DC 6, 12, 24, 48, 100 (100/110) V

#### Surge suppression

- D: With diode    R: With CR circuit



#### Contact material

Contact arrangement	Contact material	
	AgSnO <sub>2</sub> type	AgNi type
1 Form C	F	
2 Form C	F	
3 Form C	F	
4 Form C		Nil
4-pole bifurcated (twin)		Nil

Notes: Certified by UL and CSA (except for keep type)

Please consult us about VDE (1 Form C, 2 Form C, and 4 Form C only) and TV-3 (1 Form C and 2 Form C only) approved products.

**LINEUP**

Type	Contact arrangement		 Plug-in terminal type		 PC board terminal type		 Top mounting type (TM type)	Remarks
			Without LED	With LED	Without LED	With LED		
			HC relay Standard type	Single side stable	1 Form C	A		
	2 Form C	A	A		A	A	A	
	3 Form C	A	A		A	A	A	
	4 Form C	A	A		A	A	A	
	Bifurcated (Twin)	4 Form C	A		A	A	A	A
HC relay Amber sealed type	Single side stable	1 Form C	A	A	A	A	A	
		2 Form C	A	A	A	A	A	
		4 Form C	A	A	A	A	A	
	Bifurcated (Twin)	4 Form C	A	A	A	A	A	
HC keep (latching) relay	Single side stable	2 Form C	A (With operating indication)	—	A (With operating indication)	—	—	
DC type with surge absorbing diode	Single side stable	1 Form C	A	A	—	—	—	Amber sealed type also available
		2 Form C	A	A	—	—	—	
		3 Form C	A	A	—	—	—	
		4 Form C	A	A	—	—	—	
	Bifurcated (Twin)	4 Form C	A	A	—	—	—	
AC type with surge absorbing CR circuit	Single side stable	1 Form C	A	A	—	—	—	17 mm higher than standard type
		2 Form C	A	A	—	—	—	
		3 Form C	A	A	—	—	—	
		4 Form C	A	A	—	—	—	
	Bifurcated (Twin)	4 Form C	A	A	—	—	—	

A: Available  
 Notes: 1. HC relays with ground terminals also available.  
 2. HC relays with 0.9 mm wide PC board terminals also available.

**HC RELAY CONTACT ARRANGEMENT**

Type	Single side stable contact	4-pole bifurcated (twin) contact
Part number	HC□	HC4D
Features	Suitable for high-capacity load switching Standard type HC relays have high single-contact capacity; 1 Form C: 10 A 2 Form C and 3 Form C: 7 A 4 Form C: 5 A	Bifurcated (twin) contact ensures high contact reliability Suitable for low level loads Minimum switching capability: 100 μA 100m V DC (reference value)

**LED INDICATION TYPE**

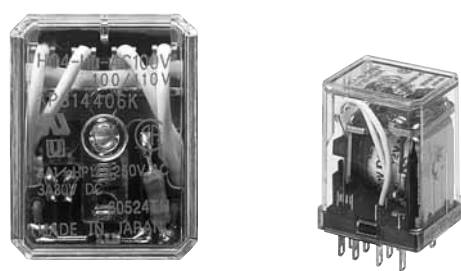
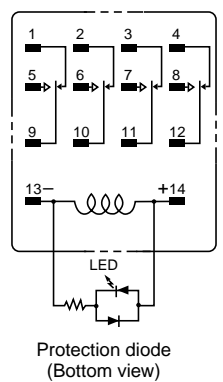
Type	With LED indication type	
Part number	HC□-HL	
Features	LED lights up when relay is operating Inspection and detection of trouble is easy. LEDs are green for DC types and red for AC types. All types are available with LED indication.	 <p>• LED colors indicate the type of relay:                      red for AC type and green for DC type.</p>  <p>Protection diode (Bottom view)</p>



**Discontinued: Keep type**  
**Last time buy: August 31, 2012**

HC

## HC RELAY SERIES PRODUCT TYPES

Type	Amber sealed type HC relay	HC keep (Latching) relay	HC relay with diode type (for DC)
Part number	HC□E	HC2K	HC□-□-□V-D
Features	Relay is completely sealed with resin. Provides high reliability in adverse surroundings. Suitable for use in dusty conditions or where organic gases are present	Magnetic latching relay Suitable for nominal operating power saving of operating circuits and for memory circuits Has operating indication (mechanical indicator).	Has built-in diode to absorb surge when the coil goes to the off state (for DC type). Suitable for protecting relay driver circuits and for noise suppression Diode characteristics: Reverse breakdown voltage 1,000 V Forward current 1 A
Type	HC relay with CR circuit (for AC)	—	—
Part number	HC□-□-□V-R	—	—
Features	Has built-in CR circuit to absorb surge when the coil goes to the off state (for AC). Relay with CR circuit is 17 mm higher than standard type relay.	—	—

4-pole bifurcated (twin) type and Relay with LED indication are available.

## TYPES

### 1. Standard type

#### 1) Plug-in type

Nominal coil voltage	1 Form C	2 Form C	3 Form C	4 Form C	4 Form C (twin)
	Part No.	Part No.	Part No.	Part No.	Part No.
6V AC	HC1-H-AC6V-F	HC2-H-AC6V-F	HC3-H-AC6V-F	HC4-H-AC6V	HC4D-H-AC6V
12V AC	HC1-H-AC12V-F	HC2-H-AC12V-F	HC3-H-AC12V-F	HC4-H-AC12V	HC4D-H-AC12V
24V AC	HC1-H-AC24V-F	HC2-H-AC24V-F	HC3-H-AC24V-F	HC4-H-AC24V	HC4D-H-AC24V
48V AC	HC1-H-AC48V-F	HC2-H-AC48V-F	HC3-H-AC48V-F	HC4-H-AC48V	HC4D-H-AC48V
100/110V AC	HC1-H-AC100V-F	HC2-H-AC100V-F	HC3-H-AC100V-F	HC4-H-AC100V	HC4D-H-AC100V
110/120V AC	HC1-H-AC120V-F	HC2-H-AC120V-F	HC3-H-AC120V-F	HC4-H-AC120V	HC4D-H-AC120V
200/220V AC	HC1-H-AC200V-F	HC2-H-AC200V-F	HC3-H-AC200V-F	HC4-H-AC200V	HC4D-H-AC200V
220/240V AC	HC1-H-AC240V-F	HC2-H-AC240V-F	HC3-H-AC240V-F	HC4-H-AC240V	HC4D-H-AC240V
6V DC	HC1-H-DC6V-F	HC2-H-DC6V-F	HC3-H-DC6V-F	HC4-H-DC6V	HC4D-H-DC6V
12V DC	HC1-H-DC12V-F	HC2-H-DC12V-F	HC3-H-DC12V-F	HC4-H-DC12V	HC4D-H-DC12V
24V DC	HC1-H-DC24V-F	HC2-H-DC24V-F	HC3-H-DC24V-F	HC4-H-DC24V	HC4D-H-DC24V
48V DC	HC1-H-DC48V-F	HC2-H-DC48V-F	HC3-H-DC48V-F	HC4-H-DC48V	HC4D-H-DC48V
100/110V DC	HC1-H-DC100V-F	HC2-H-DC100V-F	HC3-H-DC100V-F	HC4-H-DC100V	HC4D-H-DC100V

Standard packing: Carton: 20 pcs.; Case: 200 pcs.

#### 2) Plug-in type (with LED indication)

Nominal coil voltage	1 Form C	2 Form C	3 Form C	4 Form C	4 Form C (twin)
	Part No.	Part No.	Part No.	Part No.	Part No.
6V AC	HC1-HL-AC6V-F	HC2-HL-AC6V-F	HC3-HL-AC6V-F	HC4-HL-AC6V	HC4D-HL-AC6V
12V AC	HC1-HL-AC12V-F	HC2-HL-AC12V-F	HC3-HL-AC12V-F	HC4-HL-AC12V	HC4D-HL-AC12V
24V AC	HC1-HL-AC24V-F	HC2-HL-AC24V-F	HC3-HL-AC24V-F	HC4-HL-AC24V	HC4D-HL-AC24V
100/110V AC	HC1-HL-AC100V-F	HC2-HL-AC100V-F	HC3-HL-AC100V-F	HC4-HL-AC100V	HC4D-HL-AC100V
110/120V AC	HC1-HL-AC120V-F	HC2-HL-AC120V-F	HC3-HL-AC120V-F	HC4-HL-AC120V	HC4D-HL-AC120V
200/220V AC	HC1-HL-AC200V-F	HC2-HL-AC200V-F	HC3-HL-AC200V-F	HC4-HL-AC200V	HC4D-HL-AC200V
220/240V AC	HC1-HL-AC240V-F	HC2-HL-AC240V-F	HC3-HL-AC240V-F	HC4-HL-AC240V	HC4D-HL-AC240V
6V DC	HC1-HL-DC6V-F	HC2-HL-DC6V-F	HC3-HL-DC6V-F	HC4-HL-DC6V	HC4D-HL-DC6V
12V DC	HC1-HL-DC12V-F	HC2-HL-DC12V-F	HC3-HL-DC12V-F	HC4-HL-DC12V	HC4D-HL-DC12V
24V DC	HC1-HL-DC24V-F	HC2-HL-DC24V-F	HC3-HL-DC24V-F	HC4-HL-DC24V	HC4D-HL-DC24V
48V DC	HC1-HL-DC48V-F	HC2-HL-DC48V-F	HC3-HL-DC48V-F	HC4-HL-DC48V	HC4D-HL-DC48V
100/110V DC	HC1-HL-DC100V-F	HC2-HL-DC100V-F	HC3-HL-DC100V-F	HC4-HL-DC100V	HC4D-HL-DC100V

Standard packing: Carton: 20 pcs.; Case: 200 pcs.

### 3) PC board type

Nominal coil voltage	1 Form C	2 Form C	3 Form C	4 Form C	4 Form C (twin)
	Part No.	Part No.	Part No.	Part No.	Part No.
6V AC	HC1-HP-AC6V-F	HC2-HP-AC6V-F	HC3-HP-AC6V-F	HC4-HP-AC6V	HC4D-HP-AC6V
12V AC	HC1-HP-AC12V-F	HC2-HP-AC12V-F	HC3-HP-AC12V-F	HC4-HP-AC12V	HC4D-HP-AC12V
24V AC	HC1-HP-AC24V-F	HC2-HP-AC24V-F	HC3-HP-AC24V-F	HC4-HP-AC24V	HC4D-HP-AC24V
48V AC	HC1-HP-AC48V-F	HC2-HP-AC48V-F	HC3-HP-AC48V-F	HC4-HP-AC48V	HC4D-HP-AC48V
100/110V AC	HC1-HP-AC100V-F	HC2-HP-AC100V-F	HC3-HP-AC100V-F	HC4-HP-AC100V	HC4D-HP-AC100V
110/120V AC	HC1-HP-AC120V-F	HC2-HP-AC120V-F	HC3-HP-AC120V-F	HC4-HP-AC120V	HC4D-HP-AC120V
200/220V AC	HC1-HP-AC200V-F	HC2-HP-AC200V-F	HC3-HP-AC200V-F	HC4-HP-AC200V	HC4D-HP-AC200V
220/240V AC	HC1-HP-AC240V-F	HC2-HP-AC240V-F	HC3-HP-AC240V-F	HC4-HP-AC240V	HC4D-HP-AC240V
6V DC	HC1-HP-DC6V-F	HC2-HP-DC6V-F	HC3-HP-DC6V-F	HC4-HP-DC6V	HC4D-HP-DC6V
12V DC	HC1-HP-DC12V-F	HC2-HP-DC12V-F	HC3-HP-DC12V-F	HC4-HP-DC12V	HC4D-HP-DC12V
24V DC	HC1-HP-DC24V-F	HC2-HP-DC24V-F	HC3-HP-DC24V-F	HC4-HP-DC24V	HC4D-HP-DC24V
48V DC	HC1-HP-DC48V-F	HC2-HP-DC48V-F	HC3-HP-DC48V-F	HC4-HP-DC48V	HC4D-HP-DC48V
100/110V DC	HC1-HP-DC100V-F	HC2-HP-DC100V-F	HC3-HP-DC100V-F	HC4-HP-DC100V	HC4D-HP-DC100V

Standard packing: Carton: 20 pcs.; Case: 200 pcs.

Note: Please add "-31" before "-F" in the part number when ordering the PC board type 0.9 mm width terminal (ex) HC1-HP-AC6V-31-F.

### 4) PC board type (with LED indication)

Nominal coil voltage	1 Form C	2 Form C	3 Form C	4 Form C	4 Form C (twin)
	Part No.	Part No.	Part No.	Part No.	Part No.
6V AC	HC1-HPL-AC6V-F	HC2-HPL-AC6V-F	HC3-HPL-AC6V-F	HC4-HPL-AC6V	HC4D-HPL-AC6V
12V AC	HC1-HPL-AC12V-F	HC2-HPL-AC12V-F	HC3-HPL-AC12V-F	HC4-HPL-AC12V	HC4D-HPL-AC12V
24V AC	HC1-HPL-AC24V-F	HC2-HPL-AC24V-F	HC3-HPL-AC24V-F	HC4-HPL-AC24V	HC4D-HPL-AC24V
100/110V AC	HC1-HPL-AC100V-F	HC2-HPL-AC100V-F	HC3-HPL-AC100V-F	HC4-HPL-AC100V	HC4D-HPL-AC100V
110/120V AC	HC1-HPL-AC120V-F	HC2-HPL-AC120V-F	HC3-HPL-AC120V-F	HC4-HPL-AC120V	HC4D-HPL-AC120V
200/220V AC	HC1-HPL-AC200V-F	HC2-HPL-AC200V-F	HC3-HPL-AC200V-F	HC4-HPL-AC200V	HC4D-HPL-AC200V
6V DC	HC1-HPL-DC6V-F	HC2-HPL-DC6V-F	HC3-HPL-DC6V-F	HC4-HPL-DC6V	HC4D-HPL-DC6V
12V DC	HC1-HPL-DC12V-F	HC2-HPL-DC12V-F	HC3-HPL-DC12V-F	HC4-HPL-DC12V	HC4D-HPL-DC12V
24V DC	HC1-HPL-DC24V-F	HC2-HPL-DC24V-F	HC3-HPL-DC24V-F	HC4-HPL-DC24V	HC4D-HPL-DC24V
48V DC	HC1-HPL-DC48V-F	HC2-HPL-DC48V-F	HC3-HPL-DC48V-F	HC4-HPL-DC48V	HC4D-HPL-DC48V
100/110V DC	HC1-HPL-DC100V-F	HC2-HPL-DC100V-F	HC3-HPL-DC100V-F	HC4-HPL-DC100V	HC4D-HPL-DC100V

Standard packing: Carton: 20 pcs.; Case: 200 pcs.

Note: Please add "-31" before "-F" in the part number when ordering the PC board type 0.9 mm width terminal (ex) HC1-HPL-AC6V-31-F.

### 5) TM type

Nominal coil voltage	1 Form C	2 Form C	3 Form C	4 Form C	4 Form C (twin)
	Part No.	Part No.	Part No.	Part No.	Part No.
6V AC	HC1-HTM-AC6V-F	HC2-HTM-AC6V-F	HC3-HTM-AC6V-F	HC4-HTM-AC6V	HC4D-HTM-AC6V
12V AC	HC1-HTM-AC12V-F	HC2-HTM-AC12V-F	HC3-HTM-AC12V-F	HC4-HTM-AC12V	HC4D-HTM-AC12V
24V AC	HC1-HTM-AC24V-F	HC2-HTM-AC24V-F	HC3-HTM-AC24V-F	HC4-HTM-AC24V	HC4D-HTM-AC24V
48V AC	HC1-HTM-AC48V-F	HC2-HTM-AC48V-F	HC3-HTM-AC48V-F	HC4-HTM-AC48V	HC4D-HTM-AC48V
100/110V AC	HC1-HTM-AC100V-F	HC2-HTM-AC100V-F	HC3-HTM-AC100V-F	HC4-HTM-AC100V	HC4D-HTM-AC100V
110/120V AC	HC1-HTM-AC120V-F	HC2-HTM-AC120V-F	HC3-HTM-AC120V-F	HC4-HTM-AC120V	HC4D-HTM-AC120V
200/220V AC	HC1-HTM-AC200V-F	HC2-HTM-AC200V-F	HC3-HTM-AC200V-F	HC4-HTM-AC200V	HC4D-HTM-AC200V
6V DC	HC1-HTM-DC6V-F	HC2-HTM-DC6V-F	HC3-HTM-DC6V-F	HC4-HTM-DC6V	HC4D-HTM-DC6V
12V DC	HC1-HTM-DC12V-F	HC2-HTM-DC12V-F	HC3-HTM-DC12V-F	HC4-HTM-DC12V	HC4D-HTM-DC12V
24V DC	HC1-HTM-DC24V-F	HC2-HTM-DC24V-F	HC3-HTM-DC24V-F	HC4-HTM-DC24V	HC4D-HTM-DC24V
48V DC	HC1-HTM-DC48V-F	HC2-HTM-DC48V-F	HC3-HTM-DC48V-F	HC4-HTM-DC48V	HC4D-HTM-DC48V
100/110V DC	HC1-HTM-DC100V-F	HC2-HTM-DC100V-F	HC3-HTM-DC100V-F	HC4-HTM-DC100V	HC4D-HTM-DC100V

Standard packing: Carton: 20 pcs.; Case: 200 pcs.



**Discontinued: Keep type**  
**Last time buy: August 31, 2012**

HC

## 2. Amber sealed type

### 1) Plug-in type

Nominal coil voltage	1 Form C	2 Form C	4 Form C	4 Form C (twin)
	Part No.	Part No.	Part No.	Part No.
6V AC	HC1E-H-AC6V-F	HC2E-H-AC6V-F	HC4E-H-AC6V	HC4ED-H-AC6V
12V AC	HC1E-H-AC12V-F	HC2E-H-AC12V-F	HC4E-H-AC12V	HC4ED-H-AC12V
24V AC	HC1E-H-AC24V-F	HC2E-H-AC24V-F	HC4E-H-AC24V	HC4ED-H-AC24V
48V AC	HC1E-H-AC48V-F	HC2E-H-AC48V-F	HC4E-H-AC48V	HC4ED-H-AC48V
100/110V AC	HC1E-H-AC100V-F	HC2E-H-AC100V-F	HC4E-H-AC100V	HC4ED-H-AC100V
110/120V AC	HC1E-H-AC120V-F	HC2E-H-AC120V-F	HC4E-H-AC120V	HC4ED-H-AC120V
200/220V AC	HC1E-H-AC200V-F	HC2E-H-AC200V-F	HC4E-H-AC200V	HC4ED-H-AC200V
220/240V AC	HC1E-H-AC240V-F	HC2E-H-AC240V-F	HC4E-H-AC240V	HC4ED-H-AC240V
6V DC	HC1E-H-DC6V-F	HC2E-H-DC6V-F	HC4E-H-DC6V	HC4ED-H-DC6V
12V DC	HC1E-H-DC12V-F	HC2E-H-DC12V-F	HC4E-H-DC12V	HC4ED-H-DC12V
24V DC	HC1E-H-DC24V-F	HC2E-H-DC24V-F	HC4E-H-DC24V	HC4ED-H-DC24V
48V DC	HC1E-H-DC48V-F	HC2E-H-DC48V-F	HC4E-H-DC48V	HC4ED-H-DC48V
100/110V DC	HC1E-H-DC100V-F	HC2E-H-DC100V-F	HC4E-H-DC100V	HC4ED-H-DC100V

Standard packing: Carton: 20 pcs.; Case: 200 pcs.

### 2) Plug-in type (With LED indication)

Nominal coil voltage	1 Form C	2 Form C	4 Form C	4 Form C (twin)
	Part No.	Part No.	Part No.	Part No.
6V AC	HC1E-L-AC6V-F	HC2E-L-AC6V-F	HC4E-L-AC6V	HC4ED-L-AC6V
12V AC	HC1E-L-AC12V-F	HC2E-L-AC12V-F	HC4E-L-AC12V	HC4ED-L-AC12V
24V AC	HC1E-L-AC24V-F	HC2E-L-AC24V-F	HC4E-L-AC24V	HC4ED-L-AC24V
48V AC	HC1E-L-AC48V-F	HC2E-L-AC48V-F	HC4E-L-AC48V	HC4ED-L-AC48V
100/110V AC	HC1E-L-AC100V-F	HC2E-L-AC100V-F	HC4E-L-AC100V	HC4ED-L-AC100V
110/120V AC	HC1E-L-AC120V-F	HC2E-L-AC120V-F	HC4E-L-AC120V	HC4ED-L-AC120V
200/220V AC	HC1E-L-AC200V-F	HC2E-L-AC200V-F	HC4E-L-AC200V	HC4ED-L-AC200V
220/240V AC	HC1E-L-AC240V-F	HC2E-L-AC240V-F	HC4E-L-AC240V	HC4ED-L-AC240V
6V DC	HC1E-L-DC6V-F	HC2E-L-DC6V-F	HC4E-L-DC6V	HC4ED-L-DC6V
12V DC	HC1E-L-DC12V-F	HC2E-L-DC12V-F	HC4E-L-DC12V	HC4ED-L-DC12V
24V DC	HC1E-L-DC24V-F	HC2E-L-DC24V-F	HC4E-L-DC24V	HC4ED-L-DC24V
48V DC	HC1E-L-DC48V-F	HC2E-L-DC48V-F	HC4E-L-DC48V	HC4ED-L-DC48V
100/110V DC	HC1E-L-DC100V-F	HC2E-L-DC100V-F	HC4E-L-DC100V	HC4ED-L-DC100V

Standard packing: Carton: 20 pcs.; Case: 200 pcs.

### 3) PC board type

Nominal coil voltage	1 Form C	2 Form C	4 Form C	4 Form C (twin)
	Part No.	Part No.	Part No.	Part No.
6V AC	HC1E-HP-AC6V-F	HC2E-HP-AC6V-F	HC4E-HP-AC6V	HC4ED-HP-AC6V
12V AC	HC1E-HP-AC12V-F	HC2E-HP-AC12V-F	HC4E-HP-AC12V	HC4ED-HP-AC12V
24V AC	HC1E-HP-AC24V-F	HC2E-HP-AC24V-F	HC4E-HP-AC24V	HC4ED-HP-AC24V
48V AC	HC1E-HP-AC48V-F	HC2E-HP-AC48V-F	HC4E-HP-AC48V	HC4ED-HP-AC48V
100/110V AC	HC1E-HP-AC100V-F	HC2E-HP-AC100V-F	HC4E-HP-AC100V	HC4ED-HP-AC100V
110/120V AC	HC1E-HP-AC120V-F	HC2E-HP-AC120V-F	HC4E-HP-AC120V	HC4ED-HP-AC120V
200/220V AC	HC1E-HP-AC200V-F	HC2E-HP-AC200V-F	HC4E-HP-AC200V	HC4ED-HP-AC200V
220/240V AC	HC1E-HP-AC240V-F	HC2E-HP-AC240V-F	HC4E-HP-AC240V	HC4ED-HP-AC240V
6V DC	HC1E-HP-DC6V-F	HC2E-HP-DC6V-F	HC4E-HP-DC6V	HC4ED-HP-DC6V
12V DC	HC1E-HP-DC12V-F	HC2E-HP-DC12V-F	HC4E-HP-DC12V	HC4ED-HP-DC12V
24V DC	HC1E-HP-DC24V-F	HC2E-HP-DC24V-F	HC4E-HP-DC24V	HC4ED-HP-DC24V
48V DC	HC1E-HP-DC48V-F	HC2E-HP-DC48V-F	HC4E-HP-DC48V	HC4ED-HP-DC48V
100/110V DC	HC1E-HP-DC100V-F	HC2E-HP-DC100V-F	HC4E-HP-DC100V	HC4ED-HP-DC100V

Standard packing: Carton: 20 pcs.; Case: 200 pcs.

Note: Please add "-31" in the suffix of part number when ordering the PC board type 0.9 mm width terminal. (4 Form C, 4 Form C (twin) only)

## 4) PC board type (With LED indication)

Nominal coil voltage	1 Form C	2 Form C	4 Form C	4 Form C (twin)
	Part No.	Part No.	Part No.	Part No.
6V AC	HC1E-PL-AC6V-F	HC2E-PL-AC6V-F	HC4E-PL-AC6V	HC4ED-PL-AC6V
12V AC	HC1E-PL-AC12V-F	HC2E-PL-AC12V-F	HC4E-PL-AC12V	HC4ED-PL-AC12V
24V AC	HC1E-PL-AC24V-F	HC2E-PL-AC24V-F	HC4E-PL-AC24V	HC4ED-PL-AC24V
48V AC	HC1E-PL-AC48V-F	HC2E-PL-AC48V-F	HC4E-PL-AC48V	HC4ED-PL-AC48V
100/110V AC	HC1E-PL-AC100V-F	HC2E-PL-AC100V-F	HC4E-PL-AC100V	HC4ED-PL-AC100V
110/120V AC	HC1E-PL-AC120V-F	HC2E-PL-AC120V-F	HC4E-PL-AC120V	HC4ED-PL-AC120V
200/220V AC	HC1E-PL-AC200V-F	HC2E-PL-AC200V-F	HC4E-PL-AC200V	HC4ED-PL-AC200V
220/240V AC	HC1E-PL-AC240V-F	HC2E-PL-AC240V-F	HC4E-PL-AC240V	HC4ED-PL-AC240V
6V DC	HC1E-PL-DC6V-F	HC2E-PL-DC6V-F	HC4E-PL-DC6V	HC4ED-PL-DC6V
12V DC	HC1E-PL-DC12V-F	HC2E-PL-DC12V-F	HC4E-PL-DC12V	HC4ED-PL-DC12V
24V DC	HC1E-PL-DC24V-F	HC2E-PL-DC24V-F	HC4E-PL-DC24V	HC4ED-PL-DC24V
48V DC	HC1E-PL-DC48V-F	HC2E-PL-DC48V-F	HC4E-PL-DC48V	HC4ED-PL-DC48V
100/110V DC	HC1E-PL-DC100V-F	HC2E-PL-DC100V-F	HC4E-PL-DC100V	HC4ED-PL-DC100V

Standard packing: Carton: 20 pcs.; Case: 200 pcs.

Note: Please add "-31" in the suffix of part number when ordering the PC board type 0.9 mm width terminal. (4 Form C, 4 Form C (twin) only)

## 5) TM type

Nominal coil voltage	1 Form C	2 Form C	4 Form C	4 Form C (twin)
	Part No.	Part No.	Part No.	Part No.
6V AC	HC1E-HTM-AC6V-F	HC2E-HTM-AC6V-F	HC4E-HTM-AC6V	HC4ED-HTM-AC6V
12V AC	HC1E-HTM-AC12V-F	HC2E-HTM-AC12V-F	HC4E-HTM-AC12V	HC4ED-HTM-AC12V
24V AC	HC1E-HTM-AC24V-F	HC2E-HTM-AC24V-F	HC4E-HTM-AC24V	HC4ED-HTM-AC24V
48V AC	HC1E-HTM-AC48V-F	HC2E-HTM-AC48V-F	HC4E-HTM-AC48V	HC4ED-HTM-AC48V
100/110V AC	HC1E-HTM-AC100V-F	HC2E-HTM-AC100V-F	HC4E-HTM-AC100V	HC4ED-HTM-AC100V
110/120V AC	HC1E-HTM-AC120V-F	HC2E-HTM-AC120V-F	HC4E-HTM-AC120V	HC4ED-HTM-AC120V
200/220V AC	HC1E-HTM-AC200V-F	HC2E-HTM-AC200V-F	HC4E-HTM-AC200V	HC4ED-HTM-AC200V
220/240V AC	HC1E-HTM-AC240V-F	HC2E-HTM-AC240V-F	HC4E-HTM-AC240V	HC4ED-HTM-AC240V
6V DC	HC1E-HTM-DC6V-F	HC2E-HTM-DC6V-F	HC4E-HTM-DC6V	HC4ED-HTM-DC6V
12V DC	HC1E-HTM-DC12V-F	HC2E-HTM-DC12V-F	HC4E-HTM-DC12V	HC4ED-HTM-DC12V
24V DC	HC1E-HTM-DC24V-F	HC2E-HTM-DC24V-F	HC4E-HTM-DC24V	HC4ED-HTM-DC24V
48V DC	HC1E-HTM-DC48V-F	HC2E-HTM-DC48V-F	HC4E-HTM-DC48V	HC4ED-HTM-DC48V
100/110V DC	HC1E-HTM-DC100V-F	HC2E-HTM-DC100V-F	HC4E-HTM-DC100V	HC4ED-HTM-DC100V

Standard packing: Carton: 20 pcs.; Case: 200 pcs.

## 3. Keep relay

Nominal coil voltage	Plug-in type (2c)	PC board type (2c)
	Part No.	Part No.
6V AC	HC2K-AC6V-F	HC2K-P-AC6V-F
12V AC	HC2K-AC12V-F	HC2K-P-AC12V-F
24V AC	HC2K-AC24V-F	HC2K-P-AC24V-F
48V AC	HC2K-AC48V-F	HC2K-P-AC48V-F
100V AC	HC2K-AC100V-F	HC2K-P-AC100V-F
6V DC	HC2K-DC6V-F	HC2K-P-DC6V-F
12V DC	HC2K-DC12V-F	HC2K-P-DC12V-F
24V DC	HC2K-DC24V-F	HC2K-P-DC24V-F
48V DC	HC2K-DC48V-F	HC2K-P-DC48V-F
100/110V DC	HC2K-DC100V-F	HC2K-P-DC100V-F

Standard packing: Carton: 20 pcs.; Case: 200 pcs.

Note: Please refer to the "Standards Chart" for product certification.



**Discontinued: Keep type**  
**Last time buy: August 31, 2012**

HC

#### 4. With diode type (For DC)

##### 1) Plug-in type

Nominal coil voltage	1 Form C	2 Form C	3 Form C	4 Form C	4 Form C (twin)
	Part No.	Part No.	Part No.	Part No.	Part No.
6V DC	HC1-DC6V-D-F	HC2-DC6V-D-F	HC3-DC6V-D-F	HC4-DC6V-D	HC4D-DC6V-D
12V DC	HC1-DC12V-D-F	HC2-DC12V-D-F	HC3-DC12V-D-F	HC4-DC12V-D	HC4D-DC12V-D
24V DC	HC1-DC24V-D-F	HC2-DC24V-D-F	HC3-DC24V-D-F	HC4-DC24V-D	HC4D-DC24V-D
48V DC	HC1-DC48V-D-F	HC2-DC48V-D-F	HC3-DC48V-D-F	HC4-DC48V-D	HC4D-DC48V-D
100/110V DC	HC1-DC100V-D-F	HC2-DC100V-D-F	HC3-DC100V-D-F	HC4-DC100V-D	HC4D-DC100V-D

Standard packing: Carton: 20 pcs.; Case: 200 pcs.

##### 2) Plug-in type (with LED indication)

Nominal coil voltage	1 Form C	2 Form C	3 Form C	4 Form C	4 Form C (twin)
	Part No.	Part No.	Part No.	Part No.	Part No.
6V DC	HC1-L-DC6V-D-F	HC2-L-DC6V-D-F	HC3-L-DC6V-D-F	HC4-L-DC6V-D	HC4D-L-DC6V-D
12V DC	HC1-L-DC12V-D-F	HC2-L-DC12V-D-F	HC3-L-DC12V-D-F	HC4-L-DC12V-D	HC4D-L-DC12V-D
24V DC	HC1-L-DC24V-D-F	HC2-L-DC24V-D-F	HC3-L-DC24V-D-F	HC4-L-DC24V-D	HC4D-L-DC24V-D
48V DC	HC1-L-DC48V-D-F	HC2-L-DC48V-D-F	HC3-L-DC48V-D-F	HC4-L-DC48V-D	HC4D-L-DC48V-D
100/110V DC	HC1-L-DC100V-D-F	HC2-L-DC100V-D-F	HC3-L-DC100V-D-F	HC4-L-DC100V-D	HC4D-L-DC100V-D

Standard packing: Carton: 20 pcs.; Case: 200 pcs.

#### 5. With CR circuit type

##### 1) Plug-in type

Nominal coil voltage	1 Form C	2 Form C	3 Form C	4 Form C	4 Form C (twin)
	Part No.	Part No.	Part No.	Part No.	Part No.
100/110V AC	HC1-AC100V-R-F	HC2-AC100V-R-F	HC3-AC100V-R-F	HC4-AC100V-R	HC4D-AC100V-R
110/120V AC	HC1-AC120V-R-F	HC2-AC120V-R-F	HC3-AC120V-R-F	HC4-AC120V-R	HC4D-AC120V-R
200/220V AC	HC1-AC200V-R-F	HC2-AC200V-R-F	HC3-AC200V-R-F	HC4-AC200V-R	HC4D-AC200V-R
220/240V AC	HC1-AC240V-R-F	HC2-AC240V-R-F	HC3-AC240V-R-F	HC4-AC240V-R	HC4D-AC240V-R

Standard packing: Carton: 20 pcs.; Case: 200 pcs.

##### 2) Plug-in type (with LED indication)

Nominal coil voltage	1 Form C	2 Form C	3 Form C	4 Form C	4 Form C (twin)
	Part No.	Part No.	Part No.	Part No.	Part No.
100/110V AC	HC1-L-AC100V-R-F	HC2-L-AC100V-R-F	HC3-L-AC100V-R-F	HC4-L-AC100V-R	HC4D-L-AC100V-R
110/120V AC	HC1-L-AC120V-R-F	HC2-L-AC120V-R-F	HC3-L-AC120V-R-F	HC4-L-AC120V-R	HC4D-L-AC120V-R
200/220V AC	HC1-L-AC200V-R-F	HC2-L-AC200V-R-F	HC3-L-AC200V-R-F	HC4-L-AC200V-R	HC4D-L-AC200V-R
220/240V AC	HC1-L-AC240V-R-F	HC2-L-AC240V-R-F	HC3-L-AC240V-R-F	HC4-L-AC240V-R	HC4D-L-AC240V-R

Standard packing: Carton: 20 pcs.; Case: 200 pcs.

\* For sockets and terminal sockets, see page 87.

## RATING

### 1. Standard type

#### 1) Coil data

##### (1) AC coils (50/60Hz)

Type	Nominal coil voltage	Pick-up voltage (at 20°C 68°F)	Drop-out voltage (at 20°C 68°F)	Nominal coil current [±20%] (at 20°C 68°F)		Coil inductance		Nominal operating power		Max. applied voltage (at 70°C 158°F)
				50Hz	60Hz	N.C. condition	N.O. condition	50Hz	60Hz	
Standard	6V AC	80%V or less of nominal voltage (Initial)	30%V or more of nominal voltage (Initial)	224mA	200mA	0.078H	0.074H	1.3VA	1.2VA	110%V of nominal voltage
	12V AC			111mA	100mA	0.312H	0.295H			
	24V AC			56mA	50mA	1.243H	1.181H			
	48V AC			28mA	25mA	4.974H	4.145H			
	100/110V AC			13.4/14.7mA	12/13.2mA	23.75H	20.63H			
	110/120V AC			12.2/13.5mA	10.9/11.9mA	27.19H	25.57H			
200/220V AC	6.7/7.4mA	6/6.6mA	85.98H	81.76H						

Notes: 1. The relay operates in a range of 80% to 110% V of the voltage rating, but ideally, in consideration of temporary voltage fluctuations, it should be operated at the rated voltage. In particular, for AC operation, if the applied voltage drops to 80% V or more below the rated voltage, humming will occur and a large current will flow leading possibly to coil burnout.

2. The maximum applied voltage is the maximum voltage fluctuation value for the coil power supply. This value is not a permissible value for continuous operation. (This value differs depending on the ambient temperature. Please contact us for details.)

(2) DC coils

Type	Nominal coil voltage	Pick-up voltage (at 20°C 68°F)	Drop-out voltage (at 20°C 68°F)	Nominal coil current [±10%] (at 20°C 68°F)	Coil resistance [±10%] (at 20°C 68°F)	Nominal operating power	Max. applied voltage (at 70°C 158°F)
Standard	6V DC	80%V or less of nominal voltage (Initial)	10%V or more of nominal voltage (Initial)	150mA	40Ω	0.9W	110%V of nominal voltage
	12V DC			75mA	160Ω		
	24V DC			37mA	650Ω		
	48V DC			18.5mA	2,600Ω	1.0W	
	100/110V DC			10/11mA	10,000Ω		

- Notes: 1. The coil resistance for DC operation is the value measured when the coil temperature is 20°C 68°F. Compensate ±0.4% for every ±1°C change in temperature.  
 2. The relay operates in a range of 80% to 110% V of the voltage rating, but ideally, in consideration of temporary voltage fluctuations, it should be operated at the rated voltage.  
 3. For use with 200 V DC, connect a 10 KΩ (5W) resistor, in series, to the 100 V DC relay.  
 4. The maximum applied voltage is the maximum voltage fluctuation value for the coil power supply. This value is not a permissible value for continuous operation. (This value differs depending on the ambient temperature. Please contact us for details.)

2) Specifications

Characteristics	Item	Specifications				
		1 Form C	2 Form C	3 Form C	4 Form C	4 Form C (twin)
Contact	Arrangement					
	Contact resistance (Initial)	Max. 30 mΩ (By voltage drop 6 V DC 1A)				
	Contact material	Ag alloy (cd free) + Au flash			AgNi type + Au clad	
Rating	Nominal switching capacity (resistive load)	10A 250V AC	7A 250V AC	7A 250V AC	5A 250V AC	3A 250V AC
	Max. switching power (resistive load)	2,500VA	1,750VA	1,750VA	1,250VA	750VA
	Max. switching voltage	250VAC				
	Max. switching current	10A	7A	7A	5A	3A
	Nominal operating power	AC (50Hz): 1.3VA, AC (60Hz): 1.2VA, DC: 0.9 to 1.1W				
	Min. switching capacity (Reference value)*1	1mA 1V DC				100μA 1V DC
Electrical characteristics	Insulation resistance (Initial)	Min. 1,000MΩ (at 500V DC) Measurement at same location as "Breakdown voltage" section.				
	Breakdown voltage (Initial)	Between open contacts	700 Vrms for 1min. (Detection current: 10mA.)			
		Between contact sets	700 Vrms for 1min. (Detection current: 10mA.)			
		Between contact and coil	2,000 Vrms for 1min. (Detection current: 10mA.)			
	Temperature rise (coil) (at 70°C 158°F)	Max. 80°C 176°F (By resistive method, nominal coil voltage)				
	Operate time (at 20°C 68°F)*2	Max. 20ms (Nominal coil voltage applied to the coil, excluding contact bounce time.)				
Release time (at 20°C 68°F)*2	Max. 20ms (Nominal coil voltage applied to the coil, excluding contact bounce time.) (without diode)					
Mechanical characteristics	Shock resistance	Functional	Min. 196 m/s <sup>2</sup> (Half-wave pulse of sine wave: 11 ms; detection time: 10μs.)			
		Destructive	Min. 980 m/s <sup>2</sup> (Half-wave pulse of sine wave: 6 ms.)			
	Vibration resistance	Functional	10 to 55 Hz at double amplitude of 1 mm (Detection time: 10μs.)			
		Destructive	10 to 55 Hz at double amplitude of 2 mm			
Expected life	Mechanical	Min. 5×10 <sup>7</sup> : AC coil type (at 180 times/min.); Min. 10 <sup>8</sup> : DC coil type (at 180 times/min.)				
	Electrical	Min. 2×10 <sup>5</sup> resistive load (at 20 times/min.)	Min. 2×10 <sup>5</sup> resistive load (at 20 times/min.)	Min. 10 <sup>5</sup> resistive load (at 20 times/min.)	Min. 2×10 <sup>5</sup> resistive load (at 20 times/min.)	Min. 2×10 <sup>5</sup> resistive load (at 20 times/min.)
Conditions	Conditions for operation, transport and storage*3	Ambient temperature: -50°C to +70°C -58°F to +158°F (without LED); -50°C to +60°C -58°F to +140°F (with LED) Humidity: 5 to 85% R.H. (Not freezing and condensing at low temperature)				
	Max. Operating speed	20 times/min. (at max. rating)				
Unit weight		Approx. 30g 1.06 oz				

- Notes: \*1. This value can change due to the switching frequency, environmental conditions and desired reliability level, therefore it is recommended to check this with the actual load.  
 \*2. For the AC coil types, the operate/release time will differ depending on the phase.  
 \*3. The upper limit of the ambient temperature is the maximum temperature that can satisfy the coil temperature rise value. Refer to Usage, transport and storage conditions in NOTES.



**Discontinued: Keep type**  
**Last time buy: August 31, 2012**

HC

3) Switching capacity and expected life

(1) Electrical (at 20 times/min.)

Load	AC				DC		Expected life
	Resistive ( $\cos \phi = 1$ )		Inductive ( $\cos \phi \approx 0.4$ )		Resistive	Inductive	
Voltage	125V AC	250V AC	125V AC	250V AC	30V DC	30V DC	
1 Form C	10A	10A	5A	3A	—	—	Min. $2 \times 10^5$
	7A	7A	3A	2.5A	3A	1A	Min. $5 \times 10^5$
	5A	5A	2A	1.5A	—	—	Min. $10^6$
2 Form C	7A	7A	3.5A	2A	—	—	Min. $2 \times 10^5$
	5A	5A	2.5A	1.5A	3A	0.6A	Min. $5 \times 10^5$
	3A	3A	1.5A	1A	—	—	Min. $10^6$
3 Form C	7A	7A	—	—	—	—	Min. $10^5$
	—	—	3.5A	2A	—	—	Min. $2 \times 10^5$
	5A	5A	—	—	3A	0.4A	Min. $5 \times 10^5$
4 Form C	5A	5A	2A	1A	—	—	Min. $2 \times 10^5$
	3A	3A	1A	0.8A	3A	0.4A	Min. $5 \times 10^5$
	2A	2A	0.5A	0.4A	—	—	Min. $10^6$
4 Form C (twin)	3A	3A	1A	0.8A	3A	—	Min. $2 \times 10^5$

(2) Mechanical (at 180 times/min.)

AC coil type: Min.  $5 \times 10^7$ ; DC coil type: Min.  $10^8$

2. Amber sealed type

1) Coil data

Same coil data as HC relay standard type. Please refer to standard type information.

2) Specifications

Characteristics	Item	Specifications			
		1 Form C	2 Form C	4 Form C	4 Form C (twin)
Contact	Arrangement	1 Form C	2 Form C	4 Form C	4 Form C
Rating	Nominal switching capacity (resistive load)	5A 250V AC	3A 250V AC	2A 250V AC	1A 250V AC
	Max. switching power (resistive load)	1,250VA	700VA	500VA	250VA
	Max. switching voltage	250VAC	250VAC	250VAC	250VAC
	Max. switching current	5A	3A	2A	1A
	Min. switching capacity (Reference value)*1	1mA 100mV DC			100 $\mu$ A 100mV DC
Electrical characteristics	Temperature rise (coil) (at 60°C 140°F)	Max. 90°C 194°F (By resistive method, nominal voltage)			
Expected life	Electrical	Min. $2 \times 10^5$ resistive load (at 20 times/min.)			
Conditions	Conditions for operation, transport and storage*2	Ambient temperature: -40°C to +60°C -40°F to +140°F; Humidity: 5 to 85% R.H. (Not freezing and condensing at low temperature)			
	Ambient air pressure	760mmHg $\pm$ 20% (1,013mb $\pm$ 20%)			

Notes: Other specifications are same as standard types.

\*1. This value can change due to the switching frequency, environmental conditions and desired reliability level, therefore it is recommended to check this with the actual load.

\*2. The upper limit of the ambient temperature is the maximum temperature that can satisfy the coil temperature rise value. Refer to Usage, transport and storage conditions in NOTES.

3) Switching capacity and expected life

(1) Electrical (at 20 times/min.)

Load	AC				DC		Expected life
	Resistive ( $\cos \phi = 1$ )		Inductive ( $\cos \phi \approx 0.4$ )		Resistive	Inductive	
Voltage	125V AC	250V AC	125V AC	250V AC	30V DC	30V DC	
HC1E	5A	5A	—	—	3A	1A	Min. $2 \times 10^5$
HC2E	3A	3A	—	—	2A	0.7A	Min. $2 \times 10^5$
HC4E	2A	2A	—	—	2A	0.6A	Min. $2 \times 10^5$
HC4ED (4 Form C twin)	1A	1A	—	—	—	—	Min. $2 \times 10^5$

(2) Mechanical (at 180 times/min.)

AC coil type: Min.  $5 \times 10^7$ ; DC coil type: Min.  $10^8$

**3. Keep relay**

1) Coil data

(1) AC coils (50/60Hz)

Contact arrangement	Nominal coil voltage	Set voltage (at 20°C 68°F)	Reset voltage (at 20°C 68°F)	Nominal operating current [±10%] (at 20°C 68°F)		Nominal operating power		Max. applied voltage (at 50°C 122°F)
				Set coil	Reset coil	Set coil	Reset coil	
2 Form C	6V AC	80%V or less of nominal voltage (Initial)	80%V or less of nominal voltage (Initial)	206mA	103mA	1.23VA	0.62VA	110%V of nominal voltage
	12V AC			100mA	52mA	1.20VA	0.62VA	
	24V AC			51mA	21.4mA	1.22VA	0.51VA	
	48V AC			25.2mA	18.5mA	1.20VA	0.88VA	
	100V AC			13.3mA	7.1mA	1.33VA	0.71VA	

(2) DC coils

Contact arrangement	Nominal coil voltage	Set voltage (at 20°C 68°F)	Reset voltage (at 20°C 68°F)	Nominal operating current [±10%] (at 20°C 68°F)		Coil resistance [±10%] (at 20°C 68°F)		Nominal operating power		Max. applied voltage (at 50°C 122°F)
				Set coil	Reset coil	Set coil	Reset coil	Set coil	Reset coil	
2 Form C	6V DC	80%V or less of nominal voltage (Initial)	80%V or less of nominal voltage (Initial)	207mA	107mA	29Ω	56Ω	1.24W	0.64W	110%V of nominal voltage
	12V DC			100mA	52.2mA	120Ω	230Ω	1.20W	0.63W	
	24V DC			51.1mA	25.5mA	470Ω	941Ω	1.23W	0.61W	
	48V DC			25.3mA	13.7mA	1,897Ω	3,504Ω	1.21W	0.66W	
	100V DC			15.6mA	5.8mA	6,410Ω	17,241Ω	1.56W	0.58W	

Notes: 1. The allowable coil resistance range is ±10% when within 1,000Ω and ±15% when 1,000Ω or higher.  
2. The maximum applied voltage is the maximum voltage fluctuation value for the coil power supply. This value is not a permissible value for continuous operation. (This value differs depending on the ambient temperature. Please contact us for details.)

2) Specifications

Characteristics	Item	Specifications
Contact	Contact resistance (Initial)	Max. 50 mΩ (By voltage drop 6 V DC 1A)
Rating	Nominal switching capacity (resistive load)	3A 250V AC
	Max. switching power (resistive load)	750VA
	Max. switching current	3A
	Nominal operating power	Set coil: 1.20VA to 1.33VA; Reset coil: 0.51VA to 0.88VA
	Min. switching capacity (Reference value)*1	100μA 100mV DC
Electrical characteristics	Breakdown voltage (Initial) Between contact and coil	1,500 Vrms for 1min.
	Temperature rise (coil)	Set coil: Max. 80°C 176°F; Reset coil: Max. 50°C 122°F (at nominal coil voltage)
	Set time/Reset time (at 20°C 68°F)	Approx. 20ms/30ms (at nominal coil voltage)
Mechanical characteristics	Shock resistance Functional	Min. 98m/s <sup>2</sup> (Half-wave pulse of sine wave: 11 ms; detection time: 10μs.)
Expected life	Mechanical	Min. 10 <sup>7</sup> (at 180 times/min.)
	Electrical	Min. 2×10 <sup>5</sup> rated load (at 20 times/min.)
Conditions	Ambient temperature	-40°C to +50°C -40°F to +122°F (Not freezing and condensing at low temperature)

Notes: \*1. This value can change due to the switching frequency, environmental conditions and desired reliability level, therefore it is recommended to check this with the actual load.  
\*2. Other specifications are same as standard type HC relay. Please see the standard type HC relay.  
\*3. Please maintain (reset) the relay more than once a year. Leaving it in the set position for long periods of time will cause the magnet to attenuate over the years. This will decrease the holding power and cause failure of the set position.

**4. With diode type (For DC)**

1) Coil data

Same coil data as HC relay standard type for DC. Please refer to standard type information.  
Please connect DC coil type built-in diode correctly by verifying the coil polarity.

2) Specifications

Characteristics	Item	Specifications
Conditions	Conditions for operation, transport and storage*	Ambient temperature: -50°C to +60°C -58°F to +140°F Humidity: 5 to 85% R.H. (Not freezing and condensing at low temperature)

Notes: Other specifications are same as standard type HC relay. Please see the standard type HC relay.  
\* The upper limit of the ambient temperature is the maximum temperature that can satisfy the coil temperature rise value. Refer to Usage, transport and storage conditions in NOTES.

**5. With CR circuit type**

1) Coil data

Same coil data as HC relay standard type for AC. Please refer to standard type information.

2) Specifications

Characteristics	Item	Specifications
Electrical characteristics	Temperature rise (coil)	Max. 90°C 194°F (By resistive method, nominal voltage, rated current at 60°C 140°F)
Conditions	Conditions for operation, transport and storage*	Ambient temperature: -50°C to +60°C -58°F to +140°F Humidity: 5 to 85% R.H. (Not freezing and condensing at low temperature)

Notes: Other specifications are same as standard type HC relay. Please see the standard type HC relay.  
\* The upper limit of the ambient temperature is the maximum temperature that can satisfy the coil temperature rise value. Refer to Usage, transport and storage conditions in NOTES.



**Discontinued: Keep type**  
**Last time buy: August 31, 2012**

# REFERENCE DATA

## Standard type

### 1. Life curve

Load: 250 V AC resistive load

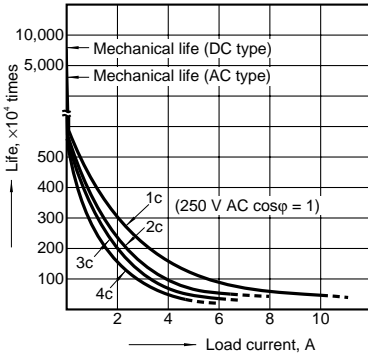

### 2.-(1) Switching capacity range (single contact type)

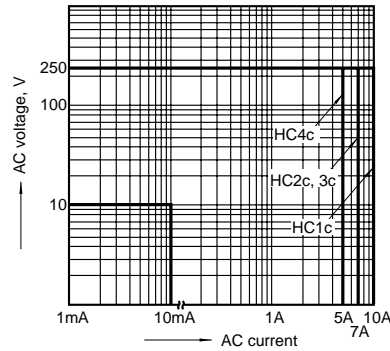

### 2.-(2) Switching capacity range (4-pole bifurcated (twin) contact type)

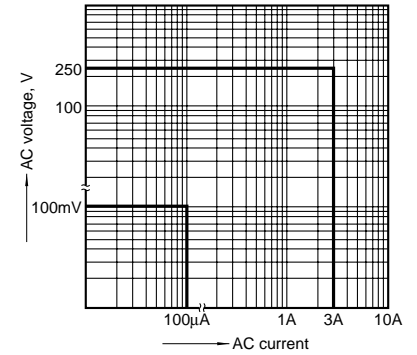

### 3.-(1) Coil temperature rise (1 Form C, AC type)

Measured portion: Inside the coil  
 Ambient temperature: 25°C 77°F

(See note.)

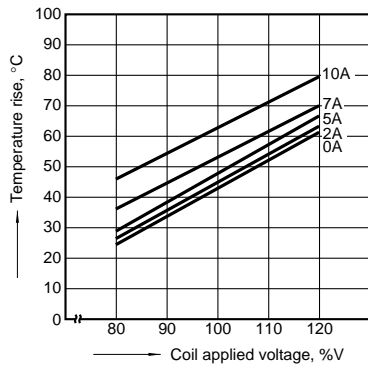

### 3.-(2) Coil temperature rise (2 Form C, AC type)

Measured portion: Inside the coil  
 Ambient temperature: 30°C 86°F

(See note.)

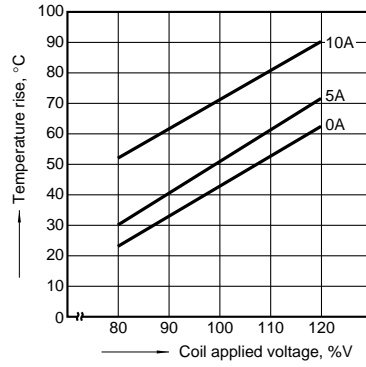

### 3.-(3) Coil temperature rise (3 Form C, AC type)

Measured portion: Inside the coil  
 Ambient temperature: 18°C 64°F

(See note.)

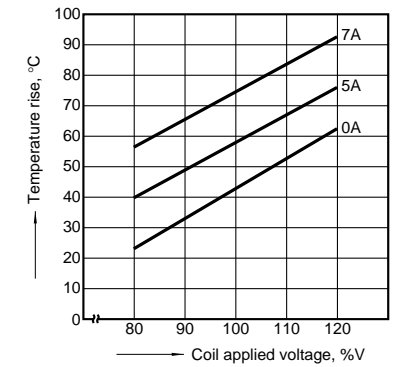

### 3.-(4) Coil temperature rise (4 Form C, AC type)

Measured portion: Inside the coil  
 Ambient temperature: 15 to 21°C 59 to 70°F

(See note.)

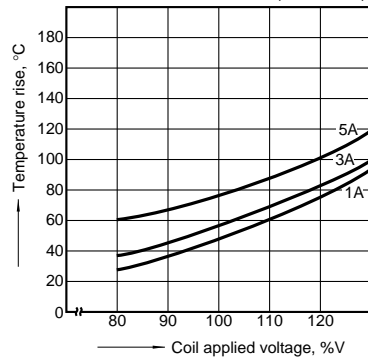

### 3.-(5) Coil temperature rise (1 Form C, DC type)

Measured portion: Inside the coil  
 Ambient temperature: 29°C 84°F

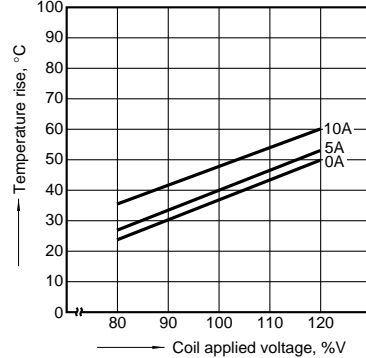

### 3.-(6) Coil temperature rise (2 Form C, DC type)

Measured portion: Inside the coil  
 Ambient temperature: 29°C 84°F

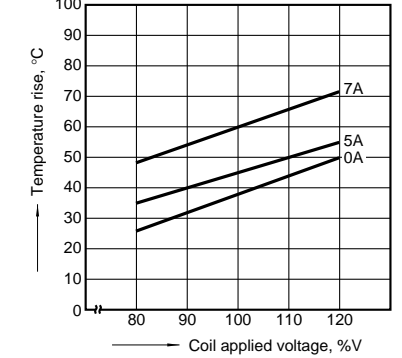

### 3.-(7) Coil temperature rise (3 Form C, DC type)

Measured portion: Inside the coil  
 Ambient temperature: 29°C 84°F

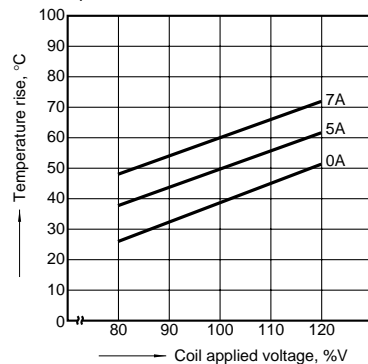

### 3.-(8) Coil temperature rise (4 Form C, DC type)

Measured portion: Inside the coil  
 Ambient temperature: 17 to 18°C 62 to 64°F

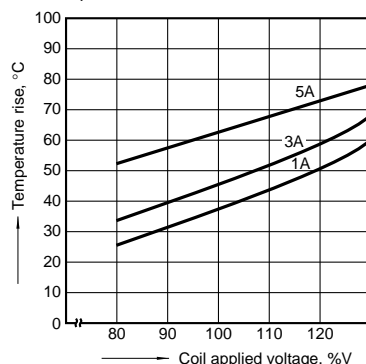

### Note: Coil temperature rise

When the nominal voltage is applied to AC 120 or 240 V coil types respectively, the figures of coil temperature rise increase by approx. 10 degrees to the ones shown on each graph.

**Amber sealed type**

1.-(1) Switching capacity range  
 (single contact type)

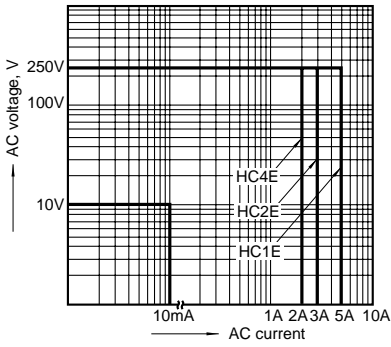

1.-(2) Switching capacity range  
 (4-pole bifurcated (twin) contact type)

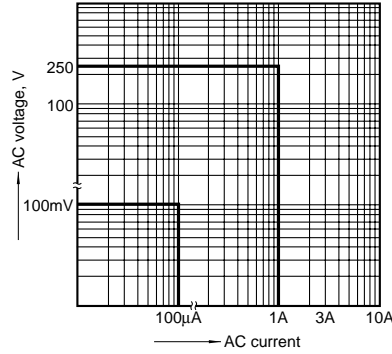

2.-(1) Coil temperature rise (1 Form C AC type)  
 Measured portion: Inside the coil  
 Ambient temperature: 30°C 86°F

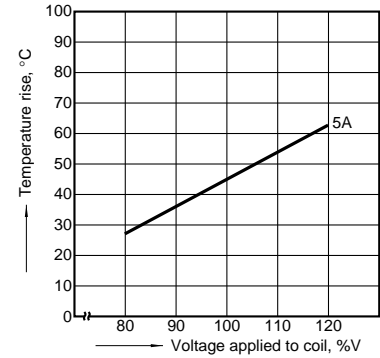

2.-(2) Coil temperature rise (2 Form C AC type)  
 Measured portion: Inside the coil  
 Ambient temperature: 30°C 86°F (See note.)

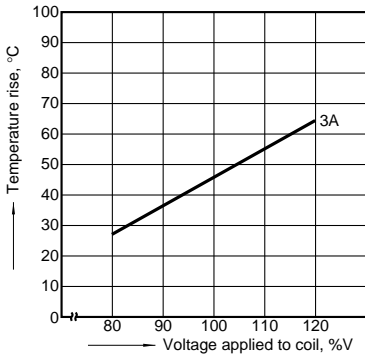

2.-(3) Coil temperature rise (4 Form C AC type)  
 Measured portion: Inside the coil  
 Ambient temperature: 30°C 86°F (See note.)

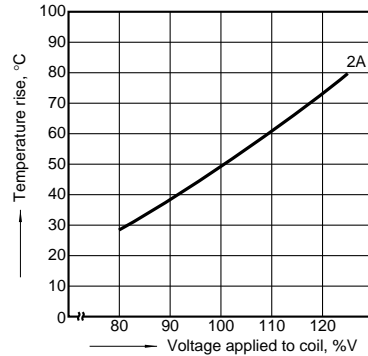

2.-(4) Coil temperature rise (1 Form C DC type)  
 Measured portion: Inside the coil  
 Ambient temperature: 30°C 86°F

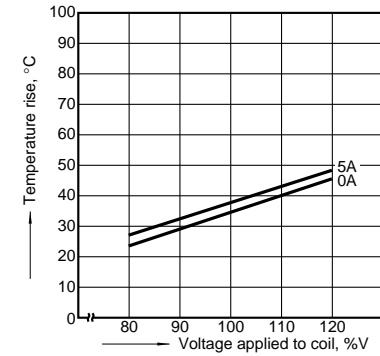

2.-(5) Coil temperature rise (2 Form C DC type)  
 Measured portion: Inside the coil  
 Ambient temperature: 30°C 86°F

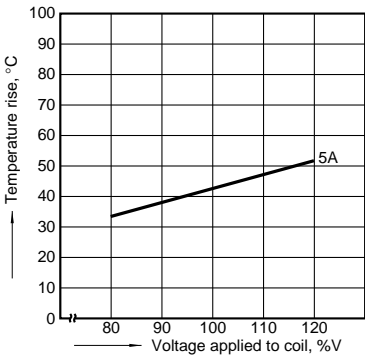

**Note: Coil temperature rise**

When the nominal voltage is applied to AC 120 or 240 V coil types respectively, the figures of coil temperature rise increase by approx. 10 degrees to the ones shown on each graph.

**Keep relay**

**Coil temperature rise**

Tested sample: HC2K-DC12V, 2 pcs  
 Measured portion: Inside the coil  
 Ambient temperature: 28°C 82.4°F

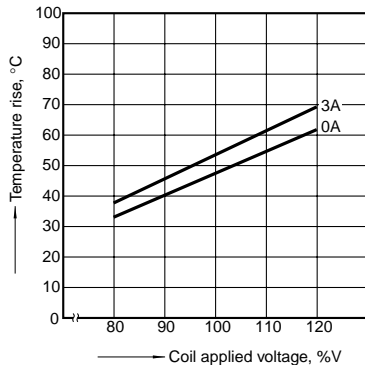



**Discontinued: Keep type**  
**Last time buy: August 31, 2012**

**With diode type (For DC)**

1.-(1) DC coil surge voltage waveform  
 (without diode)

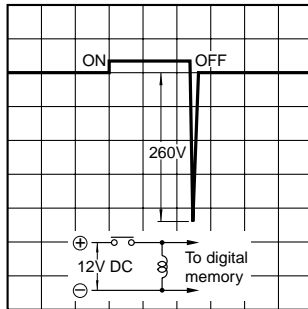

1.-(2) DC coil surge voltage waveform  
 (with diode)

Diode characteristics;  
 Reverse breakdown voltage: 1,000V,  
 Forward current: 1A

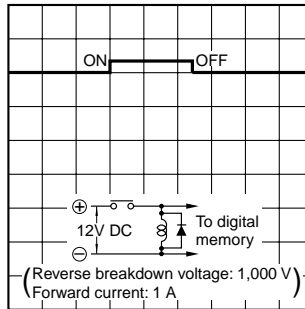

**With CR circuit type**

1.-(1) AC coil surge voltage waveform  
 (with CR circuit)

Tested sample: HC4-AC200V-R

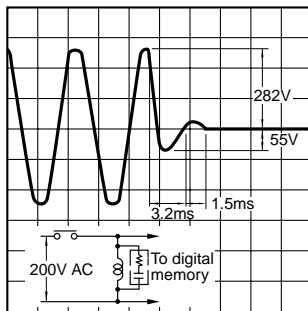

1.-(2) AC coil surge voltage waveform  
 (without CR circuit)

Tested sample: HC4-AC200V

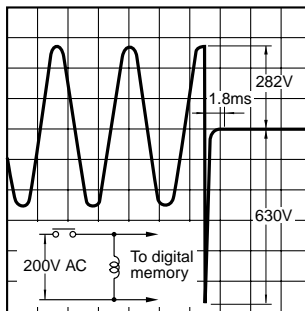

**DIMENSIONS (mm inch)**

**Standard and Amber sealed types**

1) Plug-in type  
 1 Form C

**CAD Data**



The CAD data of the products with a **CAD Data** mark can be downloaded from: <http://industrial.panasonic.com/ac/e>

**External dimensions**

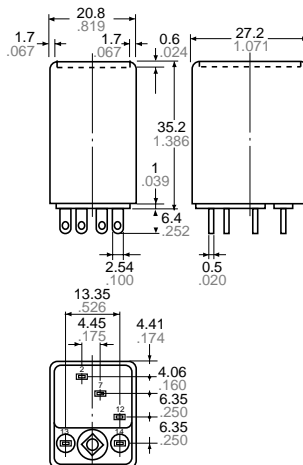

General tolerance:  $\pm 0.3 \pm 0.12$

**Schematic (Bottom view)**

**Standard type**

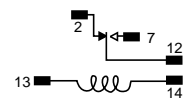

**LED AC type**

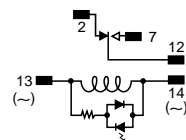

**LED DC type**

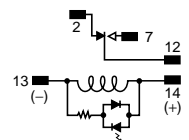

## 2 Form C

**CAD Data**



### External dimensions

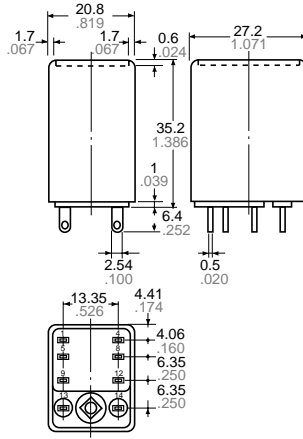

### Schematic (Bottom view)

Standard type

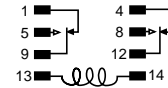

LED AC type

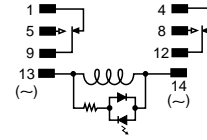

LED DC type

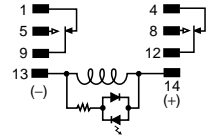

General tolerance:  $\pm 0.3 \pm 0.012$

## 3 Form C

**CAD Data**



### External dimensions

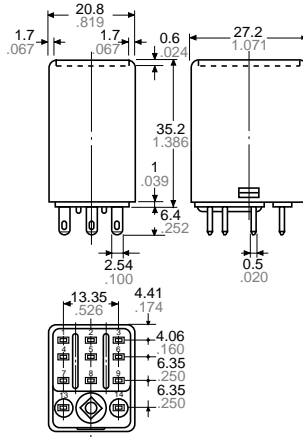

### Schematic (Bottom view)

Standard type

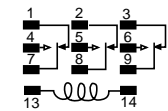

LED AC type

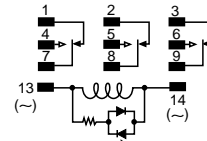

LED DC type

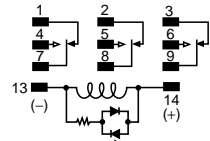

General tolerance:  $\pm 0.3 \pm 0.012$

## 4 Form C and 4-pole bifurcated (twin)

**CAD Data**



### External dimensions

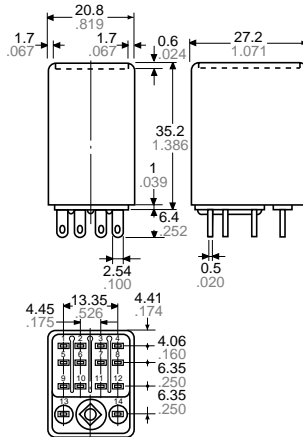

### Schematic (Bottom view)

Standard type

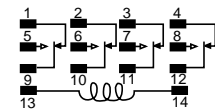

LED AC type

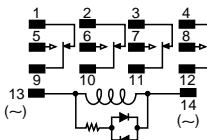

LED DC type

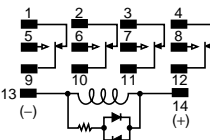

General tolerance:  $\pm 0.3 \pm 0.012$

2) PC board type  
 4 Form C

**CAD Data**



External dimensions

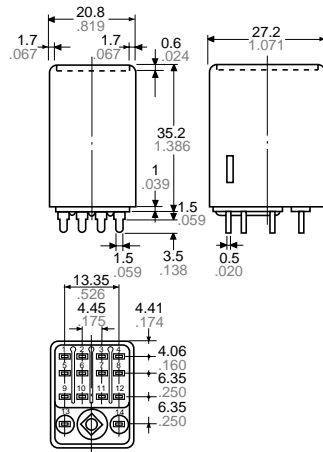

General tolerance:  $\pm 0.3 \pm 0.012$

The diagrams show the external dimensions of the 4 Form C and 4-pole bifurcated (twin) types. For 1 Form C, 2 Form C, and 3 Form C, see diagrams at plug-in types (only the terminals are different). Types with 0.9 mm terminal width are also available.

PC board pattern

1 Form C

2 Form C

3 Form C

4 Form C

Schematic

Same schematic as plug-in type HC relay

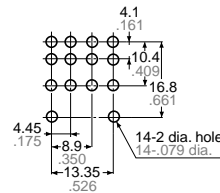
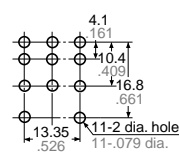
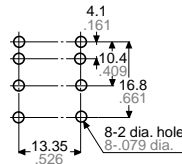
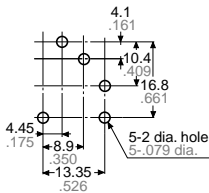

Tolerance:  $\pm 0.1 \pm 0.004$

3) TM type  
 4 Form C

**CAD Data**

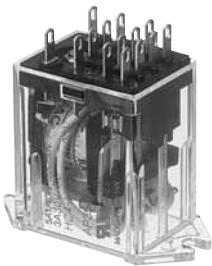

External dimensions

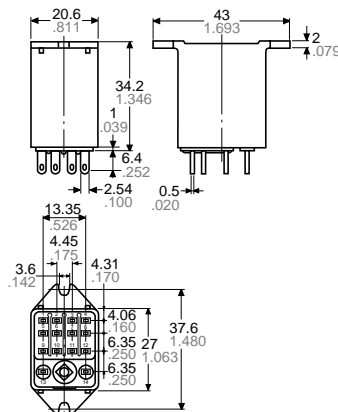

General tolerance:  $\pm 0.3 \pm 0.012$

The diagrams show the external dimensions of the 4 Form C and 4-pole bifurcated (twin) types. For 1 Form C, 2 Form C, and 3 Form C, see diagrams at plug-in types (only the terminals are different).

Chassis (Panel) cutout

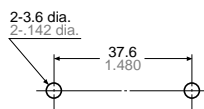

Tolerance:  $\pm 0.1 \pm 0.004$

Chassis (Panel) cutout in tandem mounting

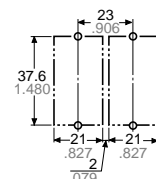

Schematic

Same schematic as plug-in type HC relay  
 Be aware that there is no LED indicator with CR circuit and built-in diode types.

- Notes: 1. In mounting, use M3 screws and M3 washers.  
 2. When mounting TM types, use washers to prevent damage or distortion to the polycarbonate cover.  
 3. When tightening fixing screws, the optimum torque range should be 0.294 to 0.49 N-m, (3 to 5 kgf-cm). Moreover, use washers to prevent loosening.

**Keep relay**  
 Plug-in type (2 Form C)

**CAD Data**



External dimensions

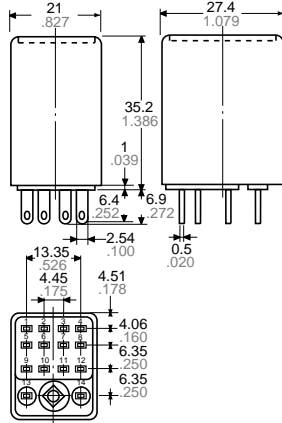

General tolerance:  $\pm 0.3 \pm .012$

Schematic (Bottom view)

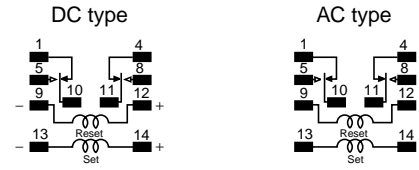

PC board type (2 Form C)

**CAD Data**



External dimensions

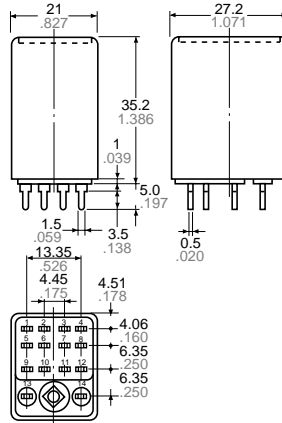

General tolerance:  $\pm 0.3 \pm .012$

Schematic (Bottom view)



PC board pattern (Bottom view)

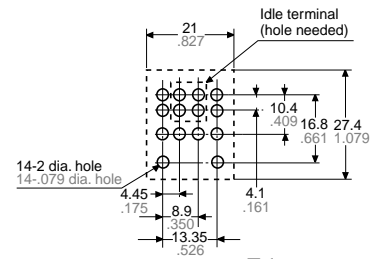

Tolerance:  $\pm 0.1 \pm .004$

**With diode type (For DC)**

Same dimensions as HC relay standard/plug-in type

**CAD Data**



Schematic

Without LED indicator

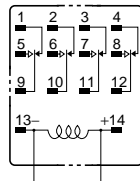

Protection (surge-absorbing) diode

With LED indicator

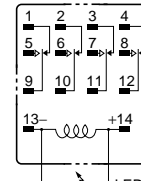

Protection (surge-absorbing) diode



**Discontinued: Keep type**  
**Last time buy: August 31, 2012**

HC

**With CR circuit type**

Plug-in type

**CAD Data**



**4 Form C External dimensions**

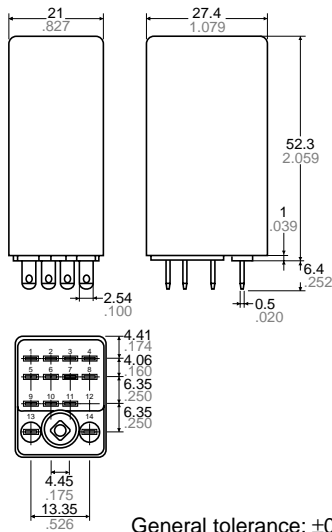

Diagrams show the external dimensions and schematic of the 4 Form C and 4-pole bifurcated (twin) types. For the 1 Form C, 2 Form C, and 3 Form C types, only the terminals differ. The dimensions of the terminal are the same as for standard type HC relays.

General tolerance:  $\pm 0.3 \pm 0.12$

**Schematic**

Without LED indicator      With LED indicator

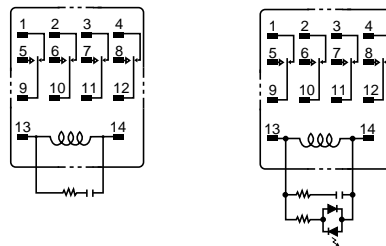

**SAFETY STANDARDS**

Item	UL/C-UL (Recognized)		CSA (Certified)		VDE (Certified)		TV rating (UL/CSA)		Remarks
	File No.	Contact rating	File No.	Contact rating	File No.	Contact rating	File No.	Rating	
HC Standard	1 Form C	E43028 10A 250V AC 1/8HP 125, 250V AC 3A 30V DC	LR26550 etc.	10A 250V AC 1/8HP 125, 250V AC 3A 30V DC	40017406	10A 250V AC (cosφ=1.0) 3A 250V AC (cosφ=0.4) 3A 30V DC (0ms)	UL E43149 CSA LR26550	TV-3	
	2 Form C	E43028 7A 250V AC 1/8HP 125, 250V AC 3A 30V DC	LR26550 etc.	7A 250V AC 1/8HP 125, 250V AC 3A 30V DC	40017406	7A 250V AC (cosφ=1.0) 2A 250V AC (cosφ=0.4) 3A 30V DC (0ms)	UL E43149 CSA LR26550	TV-3	
	3 Form C	E43028 7A 250V AC 1/8HP 125, 250V AC 3A 30V DC	LR26550 etc.	7A 250V AC 1/8HP 125, 250V AC 3A 30V DC	—	—	—	—	
	4 Form C	E43028 5A 250V AC 1/10HP 125, 250V AC 3A 30V DC	LR26550 etc.	5A 250V AC 1/10HP 125, 250V AC 3A 30V DC	40017406	5A 65V AC (cosφ=1.0) 3A 65V AC (cosφ=0.4) 3A 30V DC (0ms)	—	—	
	4 Form C twin	E43149 3A 250V AC 3A 30V DC	LR26550 etc.	3A 250V AC 3A 30V DC	—	—	—	—	
HC Amber	1 Form C	E43028 6A 250V AC 1/8HP 125, 250V AC 3A 30V DC	LR26550 etc.	6A 250V AC 1/8HP 125, 250V AC 3A 30V DC	—	—	—	—	
	2 Form C	E43028 4A 250V AC 1/10HP 125, 250V AC 3A 30V DC	LR26550 etc.	4A 250V AC 1/10HP 125, 250V AC 3A 30V DC	—	—	—	—	
	4 Form C	E43028 2A 250V AC 1/20HP 125, 250V AC 2A 30V DC	LR26550 etc.	2A 250V AC 1/20HP 125, 250V AC 2A 30V DC	—	—	—	—	
	4 Form C twin	E43149 1A 250V AC 1A 30V DC	LR26550 etc.	1A 250V AC 1A 30V DC	—	—	—	—	
HC keep	E43149 3A 250V AC 3A 30V DC	LR26550 etc.	3A 250V AC 3A 30V DC	—	—	—	—	Approved (DC type only)	

Item	UL/C-UL (Recognized)		CSA (Certified)		VDE (Certified)		TV rating (UL/CSA)		Remarks
	File No.	Contact rating	File No.	Contact rating	File No.	Contact rating	File No.	Rating	
HC with diode type (For DC)	1 Form C	E43028 10A 250V AC 1/3HP 125, 250V AC 3A 30V DC	LR26550 etc.	10A 250V AC 1/3HP 125, 250V AC 3A 30V DC	—	—	—	—	
	2 Form C	E43028 7A 250V AC 1/6HP 125, 250V AC 3A 30V DC	LR26550 etc.	7A 250V AC 1/6HP 125, 250V AC 3A 30V DC	—	—	—	—	
	3 Form C	E43028 7A 250V AC 1/6HP 125, 250V AC 3A 30V DC	LR26550 etc.	7A 250V AC 1/6HP 125, 250V AC 3A 30V DC	—	—	—	—	
	4 Form C	E43028 5A 250V AC 1/10HP 125, 250V AC 3A 30V DC	LR26550 etc.	5A 250V AC 1/10HP 125, 250V AC 3A 30V DC	—	—	—	—	
	4 Form C twin	E43149 3A 250V AC 3A 30V DC	LR26550 etc.	3A 250V AC 3A 30V DC	—	—	—	—	
HC with CR circuit	1 Form C	E43028 10A 250V AC 1/3HP 125, 250V AC 3A 30V DC	LR26550 etc.	10A 250V AC 1/3HP 125, 250V AC 3A 30V DC	—	—	—	—	
	2 Form C	E43028 7A 250V AC 1/6HP 125, 250V AC 3A 30V DC	LR26550 etc.	7A 250V AC 1/6HP 125, 250V AC 3A 30V DC	—	—	—	—	
	3 Form C	E43028 7A 250V AC 1/6HP 125, 250V AC 3A 30V DC	LR26550 etc.	7A 250V AC 1/6HP 125, 250V AC 3A 30V DC	—	—	—	—	
	4 Form C	E43028 5A 250V AC 1/10HP 125, 250V AC 3A 30V DC	LR26550 etc.	5A 250V AC 1/10HP 125, 250V AC 3A 30V DC	—	—	—	—	
	4 Form C twin	E43149 3A 250V AC 3A 30V DC	LR26550 etc.	3A 250V AC 3A 30V DC	—	—	—	—	

**NOTES**

**1. Amber sealed type**

When mounting TM types, use washers to prevent damage or distortion to the polycarbonate cover. When tightening fixing screws, the optimum torque range should be 0.294 to 0.49 N·m, (3 to 5 kgf·cm). If screws are over tightened, the cover may distort, resulting in poor sealing. Moreover, to prevent loosening, use washers.

**2. Keep relay**

- 1) The schematic differs from that in the standard type 4 Form C HC relay. Follow the schematic on the cover sticker.
- 2) Conform with the schematic for the DC type, which has a polarized coil.

3) Because retention characteristics vary according to the waveform of the voltage applied to the coil, do your best to avoid capacitor driving.

In capacitor driving, use a capacitor of 300 μF or more.

4) Ensure that the minimum pulse width of voltage applied to coil is greater than 150 ms.

**3. Diode characteristics**

- 1) Reverse breakdown voltage: 1,000 V
- 2) Forward current: 1 A

**4. Diode and CR built-in type**

Since the diode and CR inside the relay coil are designed to absorb the counter emf, the element may be damaged if a

large surge, etc., is applied to the diode and CR.



If there is the possibility of a large surge voltage from the outside, please implement measures to absorb it.

**5. Please connect DC coil types with LED and built-in diode correctly by verifying the coil polarity (“+” and “-”). Connecting with reverse polarity will cause the LED not to light and damage the built-in diode due to its specification.**

**For Cautions for Use.**

## Looking for pricing, stock, or lifecycle information?

Click below to explore more details on WIN SOURCE:

-  [View HC4E-H-DC48V on WIN SOURCE](#)
-  [Panasonic Information](#)

## Optimize Your Supply Chain with WIN SOURCE Solutions

-  Global Sourcing Solution
-  Obsolete Management
-  Cost Control Management
-  Shortage Management
-  Alternative Solution
-  Excess Inventory Management