



THE DATASHEET OF HMC190AMS8E



Typical Applications

The HMC190AMS8(E) is ideal for:

- MMDS & WirelessLAN
- Portable Wireless

Functional Diagram

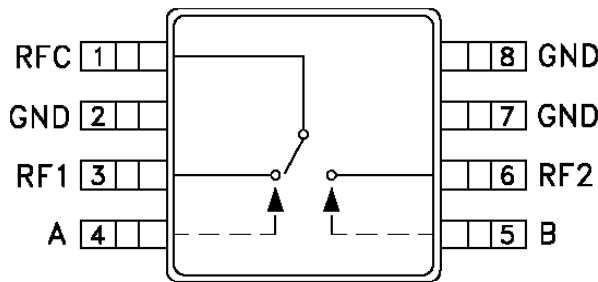

Features

- Low Insertion Loss: 0.4 dB
- Ultra Small Package: MSOP8
- High Input IP3: +50 dBm
- Positive Control: 0/+3V @ 3 μ A

General Description

The HMC190AMS8(E) is a low cost SPDT switch in a 8-lead MSOP package. The switch can control signals from DC to 3 GHz. It is especially suited for low and medium power applications using positive control voltages. The two control voltages require a minimal amount of DC current, which is optimal for battery powered radio systems at 0.9, 1.9, and 2.4 GHz. The HMC190AMS8(E) provides exceptional third order intermodulation performance of +50 dBm. The design has been optimized for the small MSOP package, and maintains a VSWR of better than 1.2:1 up to 2 GHz. This device is the positive control MSOP8 packaged version of our HMC239S8 negative control device.

Electrical Specifications, $T_A = +25^\circ C$, $V_{ctl} = 0/+3$ to $+8 Vdc$

Parameter	Frequency	Min.	Typ.	Max.	Units
Insertion Loss	DC - 1.0 GHz		0.4	0.6	dB
	DC - 2.0 GHz		0.4	0.6	dB
	DC - 2.5 GHz		0.5	0.8	dB
	DC - 3.0 GHz		0.7	1.0	dB
Isolation	DC - 1.0 GHz	23	27		dB
	DC - 2.0 GHz	23	27		dB
	DC - 2.5 GHz	22	26		dB
	DC - 3.0 GHz	19	22		dB
Return Loss	DC - 1.0 GHz	24	28		dB
	DC - 2.0 GHz	20	28		dB
	DC - 2.5 GHz	15	20		dB
	DC - 3.0 GHz	10	16		dB
Input Power for 1 dB Compression ($V_{ctl} = 0/+5V$)	0.5 - 1.0 GHz	25	30		dBm
	0.5 - 3.0 GHz	23	29		dBm
Input Third Order Intercept ($V_{ctl} = 0/+5V$)(Two-tone Input Power = +7 dBm Each Tone)	0.5 - 1.0 GHz	45	50		dBm
	0.5 - 3.0 GHz	44	49		dBm
Switching Characteristics	DC - 3.0 GHz				
		t_{RISE}, t_{FALL} (10/90% RF)		3	ns
		t_{ON}, t_{OFF} (50% CTL to 10/90% RF)		10	ns



Insertion Loss

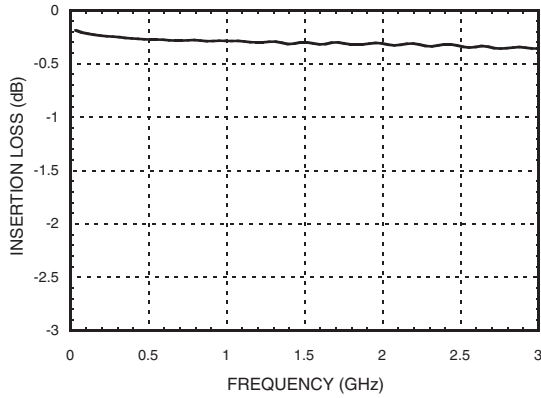

Isolation

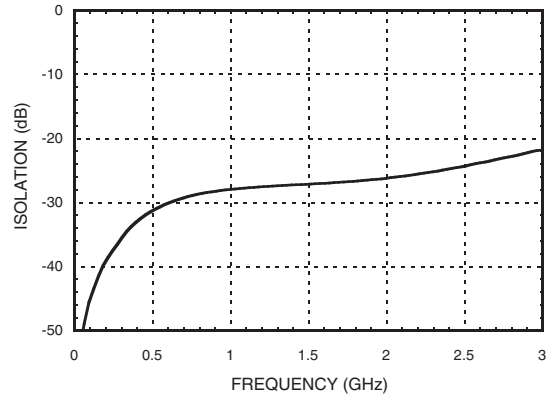

Return Loss

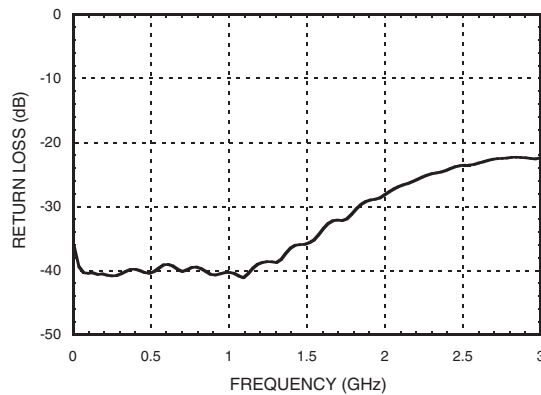

Input 0.1 and 1.0 dB Compression vs. Control Voltage

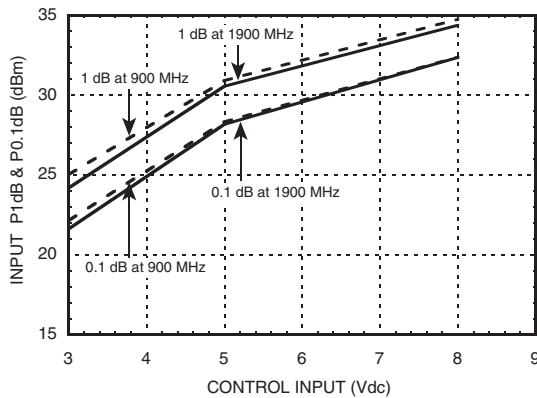

Input Third Order Intercept Point vs. Control Voltage

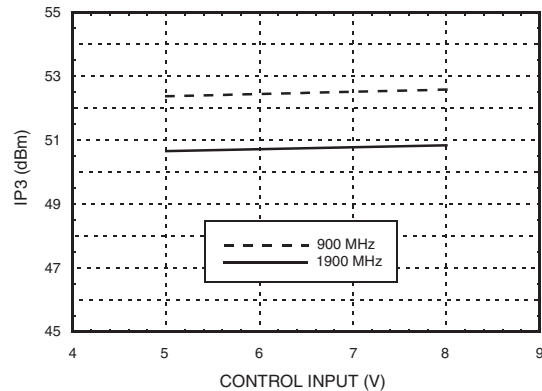

Distortion vs. Control Voltage

Control Input (Vdc)	Third Order Intercept (dBm) +7 dBm Each Tone	
	900 MHz	1900 MHz
+5	52	50
+8	52	51

Compression vs. Control Voltage

Control Input (Volts)	Carrier at 900 MHz		Carrier at 1900 MHz	
	Input Power for 0.1 dB Compression (dBm)	Input Power for 1.0 dB Compression (dBm)	Input Power for 0.1 dB Compression (dBm)	Input Power for 1.0 dB Compression (dBm)
+3	21	24	22	25
+5	27	30	27	31
+8	32	34	32	34

Truth Table

*Control Input Voltage Tolerances are ± 0.2 Vdc.

Control Input*		Control Current		Signal Path State	
A (Vdc)	B (Vdc)	Ia (μ A)	Ib (μ A)	RF to RF1	RF to RF2
0	+3	-3	3	ON	OFF
+3	0	3	-3	OFF	ON
0	+5	-5	5	ON	OFF
+5	0	5	-5	OFF	ON
0	+8	-32	32	ON	OFF
+8	0	32	-32	OFF	ON

Caution: Do not operate in 1 dB compression at power levels above +31 dBm ($V_{ctl} = +5$ Vdc) and do not "hot switch" power levels greater than +20dBm ($V_{ctl} = +5$ Vdc).

DC blocks are required at ports RFC, RF1 and RF2.

Absolute Maximum Ratings

Max. Input Power	0.5 GHz	+27 dBm
$V_{CTL} = 0/+8V$	0.5 - 2 GHz	+34 dBm
Control Voltage Range (A & B)		-0.2 to +12 Vdc
Storage Temperature		-65 to +150 °C
Operating Temperature		-40 to +85 °C
ESD Sensitivity (HBM)		Class 1A



ELECTROSTATIC SENSITIVE DEVICE
OBSERVE HANDLING PRECAUTIONS

Outline Drawing

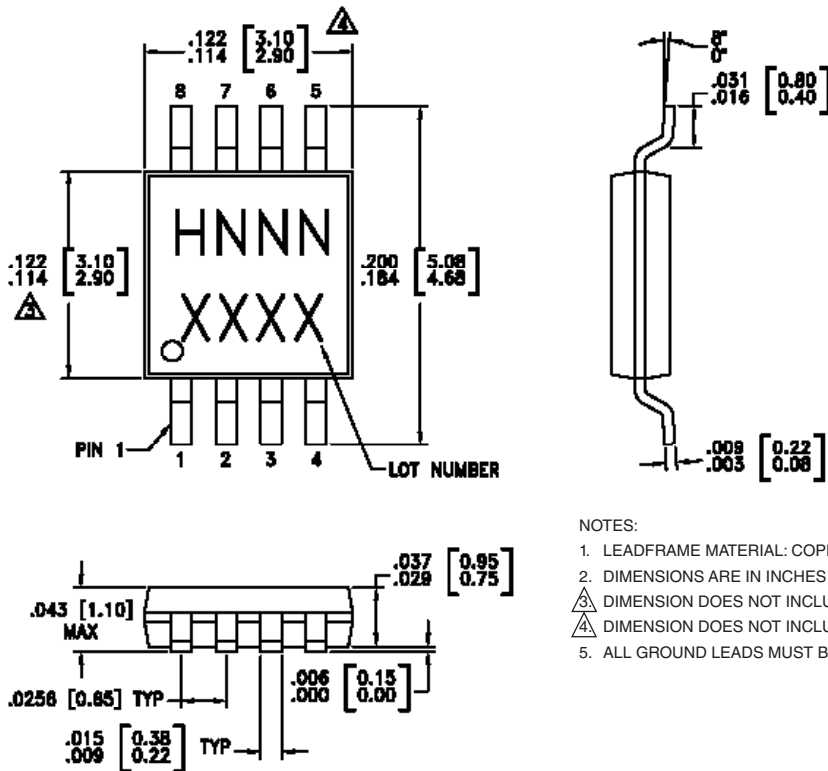

NOTES:

1. LEADFRAME MATERIAL: COPPER ALLOY
2. DIMENSIONS ARE IN INCHES [MILLIMETERS].
3. DIMENSION DOES NOT INCLUDE MOLDFLASH OF 0.15mm PER SIDE.
4. DIMENSION DOES NOT INCLUDE MOLDFLASH OF 0.25mm PER SIDE.
5. ALL GROUND LEADS MUST BE SOLDERED TO PCB RF GROUND.

Package Information

Part Number	Package Body Material	Lead Finish	MSL Rating	Package Marking ^[3]
HMC190AMS8	Low Stress Injection Molded Plastic	Sn/Pb Solder	MSL1 ^[1]	H190A XXXX
HMC190AMS8E	RoHS-compliant Low Stress Injection Molded Plastic	100% matte Sn	MSL1 ^[2]	<u>H190A</u> XXXX

[1] Max peak reflow temperature of 235 °C

[2] Max peak reflow temperature of 260 °C

[3] 4-Digit lot number XXXX

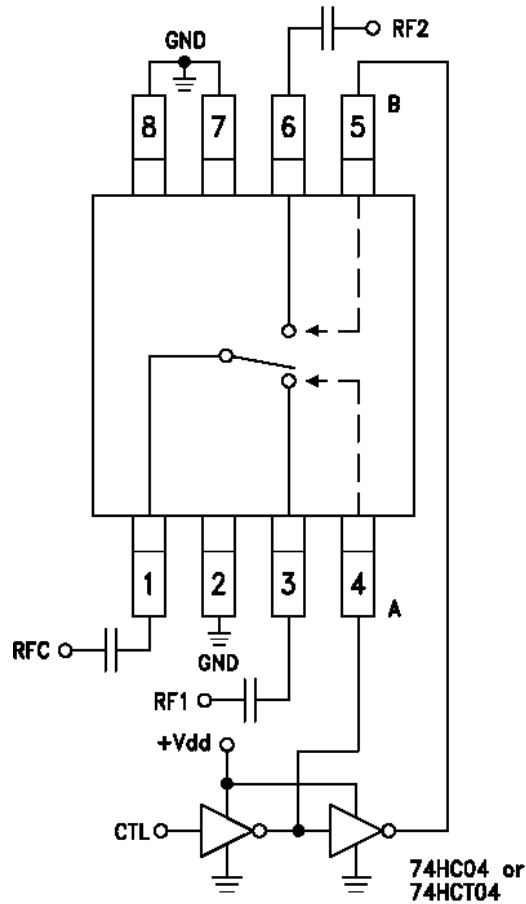
Typical Application Circuit

Notes:

1. Set logic gate and switch Vdd = +3V to +5V and use HCT series logic to provide a TTL driver interface.
2. Control inputs A/B can be driven directly with CMOS logic (HC) with Vdd of 5 to 8 Volts applied to the CMOS logic gates.
3. DC blocking capacitors are required for each RF port as shown. Capacitor value determines lowest frequency of operation.
4. Highest RF signal power capability is achieved with Vdd = +8V and A/B set to 0/+8V.

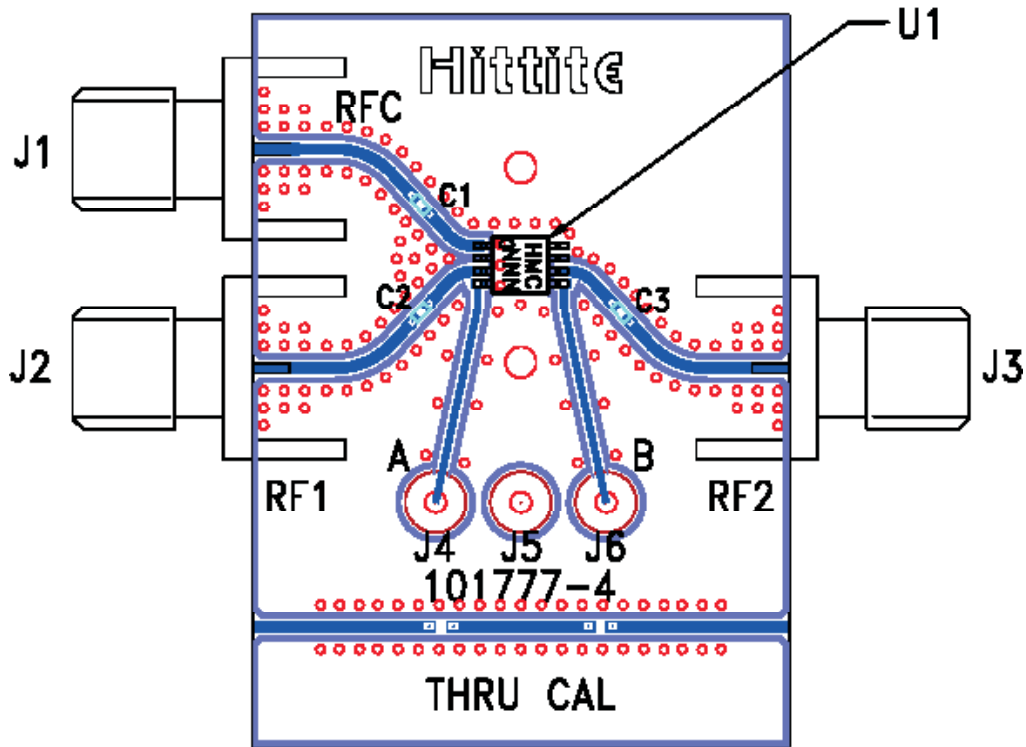

Evaluation Circuit Board



List of Materials for Evaluation PCB 101779 [1]

Item	Description
J1 - J3	PCB Mount SMA RF Connector
J4 - J6	DC Pin
C1 - C3	330 pF Capacitor, 0402 Pkg.
U1	HMC190AMS8(E) SPDT Switch
PCB [2]	101777 Evaluation PCB

[1] Reference this number when ordering complete evaluation PCB

[2] Circuit Board Material: Rogers 4350

The circuit board used in the final application should be generated with proper RF circuit design techniques. Signal lines at the RF port should have 50 Ohm impedance and the package ground leads and package bottom should be connected directly to the ground plane similar to that shown above. The evaluation circuit board shown above is available from Hittite Microwave Corporation upon request.

Looking for pricing, stock, or lifecycle information?

Click below to explore more details on WIN SOURCE:

 [View HMC190AMS8E on WIN SOURCE](#)

 [Analog Devices Inc. Information](#)

Optimize Your Supply Chain with WIN SOURCE Solutions

-  Global Sourcing Solution
-  Obsolete Management
-  Cost Control Management
-  Shortage Management
-  Alternative Solution
-  Excess Inventory Management