

5 Amp Schottky Rectifier HSM580 – HSM5100

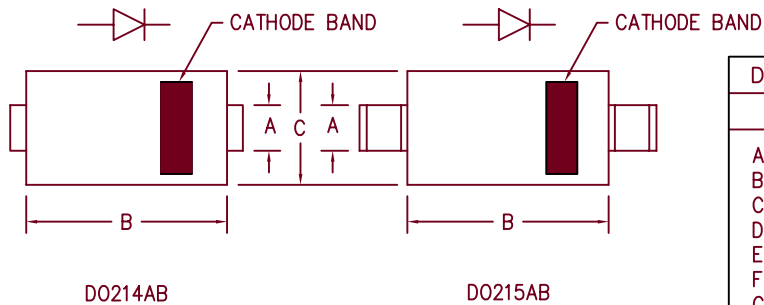

Dim.	Inches		Millimeter		Notes
	Minimum	Maximum	Minimum	Maximum	
A	.117	.123	2.97	3.12	
B	.260	.280	6.60	7.11	
C	.220	.245	5.59	6.22	
D	.307	.322	7.80	8.18	
E	.075	.095	1.91	2.41	
F	.380	.400	9.65	10.16	
G	.025	.040	.640	1.02	
H	.030	.060	.760	1.52	

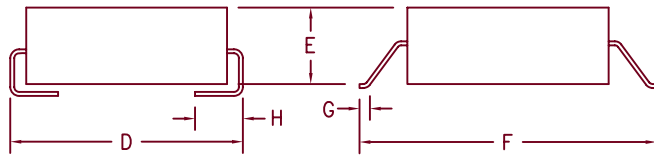

Microsemi Catalog Number	Industry Part Number	Working Peak Reverse Voltage	Repetitive Peak Reverse Voltage
HSM580*	SK58L	80V	80V
HSM590*		90V	90V
HSM5100*	SK510L	100V	100V

* Add Suffix J for J Lead or G for Gull Wing Lead Configuration

- Schottky Barrier Rectifier
- Guard Ring Protection
- High surge capacity
- VRRM 80 to 100 volts
- Surface mount packages

Electrical Characteristics

Average forward current	$I_F(AV)$ 5.0 Amps	Square wave, $T_L = 95^\circ C$, $R_{\theta JL} = 22^\circ C/W$
Maximum surge current	I_{FSM} 200 Amps	8.3ms, half sine, $T_J = 175^\circ C$
Max peak forward voltage	VFM .60 Volts	$I_{FM} = 1A; T_J = 25^\circ C^*$
Max peak forward voltage	VFM .80 Volts	$I_{FM} = 5A; T_J = 25^\circ C^*$
Max peak reverse current	I_{RM} 250 μA	$V_{RRM}, T_J = 25^\circ C$
Typical junction capacitance	C_J 280 pF	$V_R = 5.0V, T_J = 25^\circ C$

*Pulse test: Pulse width 300 μsec , Duty cycle 2%

Thermal and Mechanical Characteristics

Storage temperature range	T_{STG}	$-55^\circ C$ to $175^\circ C$
Operating junction temp range	T_J	$-55^\circ C$ to $175^\circ C$
Maximum thermal resistance	$R_{\theta JL}$	$22^\circ C/W$ Junction to lead
Weight		.008 ounces (.22 grams) typical



8700 East Thomas Road, P.O. Box 1390
Scottsdale, AZ 85252
PH: (480) 941-6300
FAX: (480) 947-1503
www.microsemi.com

05-15-07 Rev. 5

HSM580 — HSM5100

Figure 1
Typical Forward Characteristics

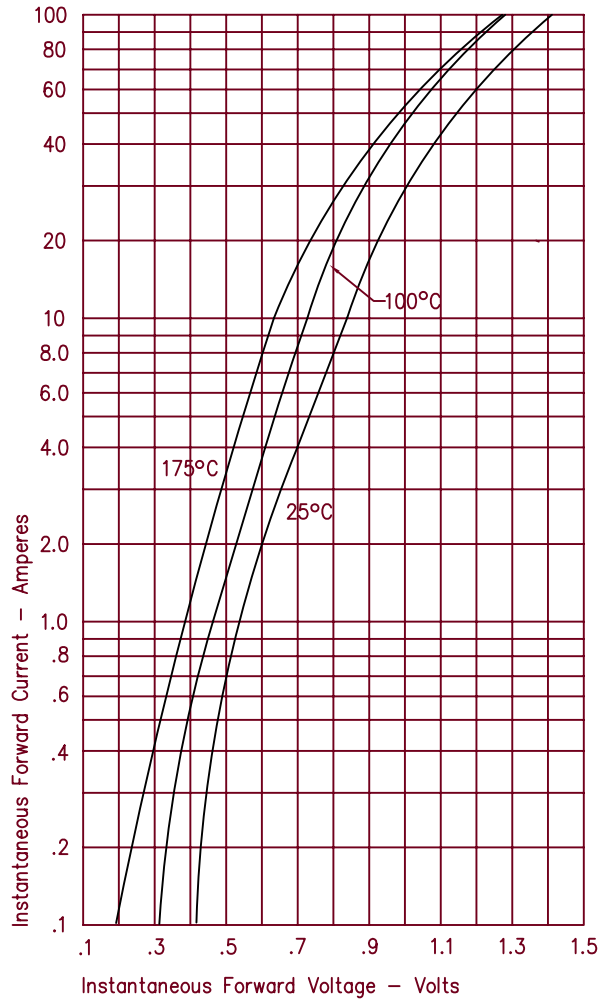

Figure 3
Typical Junction Capacitance

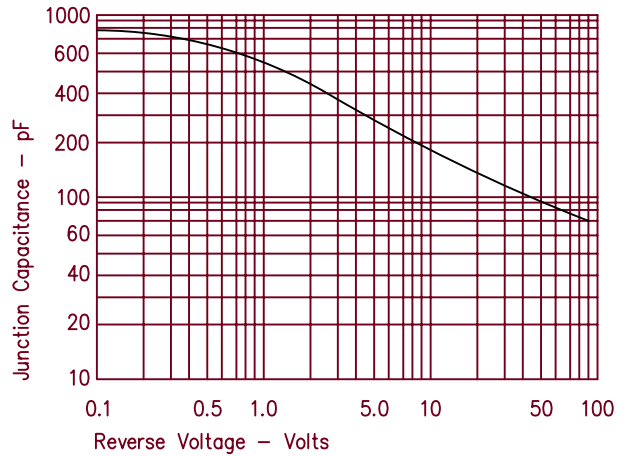

Figure 4
Forward Current Derating

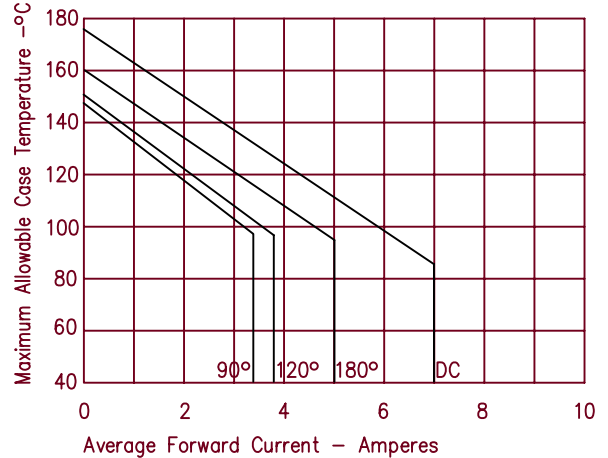

Figure 2
Typical Reverse Characteristics

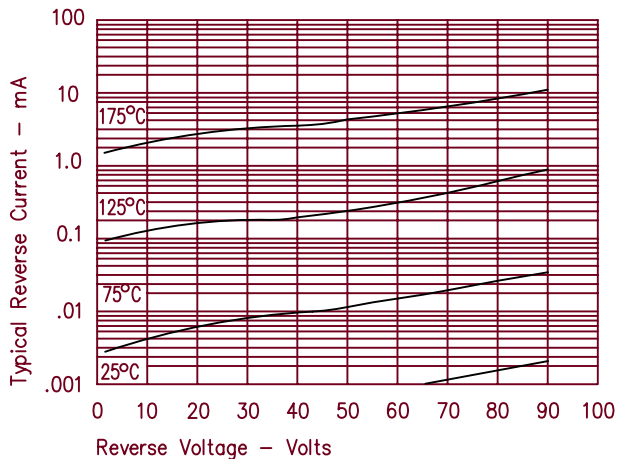
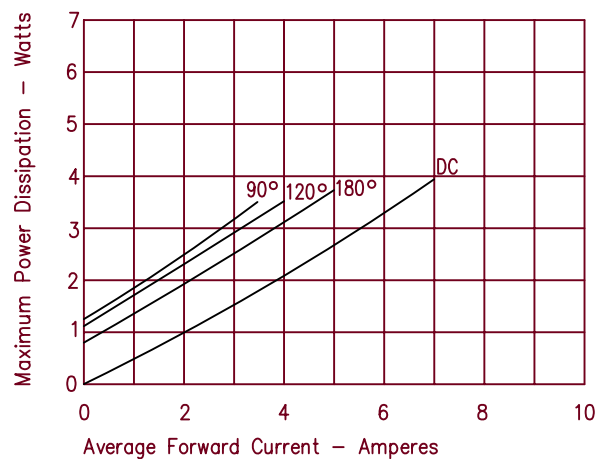

Figure 5
Maximum Power Dissipation



Looking for pricing, stock, or lifecycle information?

Click below to explore more details on WIN SOURCE:

-  [View HSM590JE3/TR13 on WIN SOURCE](#)
-  [Microsemi Corporation](#) Information

Optimize Your Supply Chain with WIN SOURCE Solutions

-  Global Sourcing Solution
-  Obsolete Management
-  Cost Control Management
-  Shortage Management
-  Alternative Solution
-  Excess Inventory Management