



**THE DATASHEET OF  
HW010A0F1-S**



## HW006/010/012 Series Power Modules; dc-dc Converters

### 36-75Vdc Input; 1.2 Vdc to 5 Vdc Output; 6.6A to 12A

### RoHS Compliant

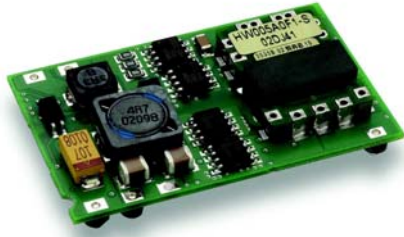

### Applications

- Wireless Networks
- Distributed power architectures
- Optical and Access Network Equipment
- Enterprise Networks
- Latest generation IC's (DSP, FPGA, ASIC) and Microprocessor powered applications

### Options

- Remote On/Off logic (positive or negative)
- Surface Mount (-S Suffix)
- Additional Vout+ pin (-3 Suffix)

### Description

The HW/HC series power modules are isolated dc-dc converters that operate over a wide input voltage range of 18 to 36 Vdc (HC) or 36 to 75 Vdc (HW) and provide one precisely regulated output. The output is fully isolated from the input, allowing versatile polarity configurations and grounding connections. The modules exhibit high efficiency, e.g. typical efficiency of 87% 3.3V/5A, 86% at 2.5V/6A. Built-in filtering for both input and output minimizes the need for external filtering. These open frame modules are available either in surface-mount (-S) or in through-hole form.

\* UL is a registered trademark of Underwriters Laboratories, Inc.

† CSA is a registered trademark of Canadian Standards Association.

‡ VDE is a trademark of Verband Deutscher Elektrotechniker e.V.

\*\* ISO is a registered trademark of the International Organization of Standards

### Features

- Compliant to RoHS EU Directive 2011/65/EU (Z versions)
- Compliant to RoHS EU Directive 2011/65/EU under exemption 7b (Lead solder exemption). Exemption 7b will expire after June 1, 2016 at which time this product will no longer be RoHS compliant (non-Z versions)
- Delivers up to 6A Output current  
5V (4A), 3.3V (5A), 2.5V – 1.0V (6A each)
- High efficiency – 89% at 5.0V full load
- Low Output voltage- supports migration to future IC supply voltages down to 1.0V
- Low output ripple and noise
- Small Size and low profile  
47.2mm x 29.5mm x 8.5mm  
(1.86 x 1.16 x 0.335 in)
- Surface mount or Through hole (TH)
- Remote On/Off
- Output overcurrent/Over voltage protection
- Over temperature protection
- Single Tightly regulated output
- Output voltage adjustment trim  $\pm 10\%$
- Wide operating temperature range (-40°C to 85°C)
- Meets the voltage insulation requirements for ETSI 300-132-2 and complies with and is Licensed for Basic Insulation rating per EN 60950
- CE mark meets 73/23/EEC and 93/68/EEC directives<sup>§</sup>
- UL\* 60950-1 Recognized, CSA† C22.2 No. 60950-1-03 Certified, and VDE‡ 0805:2001-12 (EN60950-1) Licensed
- ISO\*\* 9001 and ISO 14001 certified manufacturing facilities

## HW006/010/012 Series Power Modules; dc-dc Converters

### 36-75Vdc Input; 1.2 Vdc to 5 Vdc Output; 6.6A to 12A

#### Absolute Maximum Ratings

Stresses in excess of the absolute maximum ratings can cause permanent damage to the device. These are absolute stress ratings only, functional operation of the device is not implied at these or any other conditions in excess of those given in the operations sections of the data sheet. Exposure to absolute maximum ratings for extended periods can adversely affect the device reliability.

Parameter	Device	Symbol	Min	Max	Unit
Input Voltage	HC	$V_{IN}$	-0.3	50	Vdc
Continuous	HW	$V_{IN}$	-0.3	80	Vdc
Transient (100ms)	HW	$V_{IN,trans}$	-0.3	100	Vdc
Operating Ambient Temperature (see Thermal Considerations section)	All	$T_A$	-40	85	°C
Storage Temperature	All	$T_{stg}$	-55	125	°C
I/O Isolation Voltage (100% factory tested)	All	—	—	2250	Vdc

#### Electrical Specifications

Unless otherwise indicated, specifications apply over all operating input voltage, resistive load, and temperature conditions.

Parameter	Device	Symbol	Min	Typ	Max	Unit
Operating Input Voltage	HC	$V_{IN}$	18	24	36	Vdc
	HW	$V_{IN}$	36	54	75	Vdc
Maximum Input Current ( $V_{IN}=0V$ to 75V, $I_O=I_{O,max}$ )	HC	$I_{IN,max}$			1.75	Adc
	HW	$I_{IN,max}$			0.85	Adc
Inrush Transient	All	$I^2t$			1	A <sup>2</sup> s
Input Reflected Ripple Current, peak-to-peak (5Hz to 20MHz, 12 $\mu$ H source impedance; $V_{IN}=0V$ to 75V, $I_O=I_{O,max}$ ; see Figure 9)	All			5		mAp-p
Input Ripple Rejection (120Hz)	All			50		dB
EMC, EN55022			See EMC Considerations section			

#### CAUTION: This power module is not internally fused. An input line fuse must always be used.

This power module can be used in a wide variety of applications, ranging from simple standalone operation to being part of complex power architecture. To preserve maximum flexibility, internal fusing is not included; however, to achieve maximum safety and system protection, always use an input line fuse. The safety agencies require a fast-acting fuse with a maximum rating of 3A (see Safety Considerations section). Based on the information provided in this data sheet on inrush energy and maximum dc input current, the same type of fuse with a lower rating can be used. Refer to the fuse manufacturer's data sheet for further information.

## HW006/010/012 Series Power Modules; dc-dc Converters

36-75Vdc Input; 1.2 Vdc to 5 Vdc Output; 6.6A to 12A

### Electrical Specifications (continued)

Parameter	Device	Symbol	Min	Typ	Max	Unit
Output Voltage Set-point  ( $V_{IN}=V_{IN,nom}$ , $I_O=I_{O,max}$ , $T_{ref}=25^{\circ}C$ )	5V, 3.3V 2.5V, 2.0V, 1.8V, 1.5V	$V_{O,set}$	-1.0	—	+1.0	% $V_{O,nom}$
	1.2V, 1.0V	$V_{O,set}$	-1.25	—	+1.25	% $V_{O,nom}$
Output Voltage (Over all operating input voltage, resistive load, and temperature conditions until end of life)	All	$V_O$	-3.0	—	+3.0	% $V_{O,nom}$
Adjustment Range Selected by external resistor	All	$V_O$	-10.0		+10.0	% $V_{O,nom}$
Output Regulation Line ( $V_{IN}=V_{IN,min}$ to $V_{IN,max}$ ) Load ( $I_O=I_{O,min}$ to $I_{O,max}$ ) Temperature ( $T_{ref}=T_{A,min}$ to $T_{A,max}$ )	All All All		— — —	— — —	10 15 1.00	mV mV %
Output Ripple and Noise on nominal output ( $V_{IN}=V_{IN,nom}$ and $I_O=I_{O,min}$ to $I_{O,max}$ )						
	RMS (5Hz to 20MHz bandwidth) Peak-to-Peak (5Hz to 20MHz bandwidth)	All All	— —	8 25	15 50	$mV_{rms}$ $mV_{pk-pk}$
External Capacitance	All	$C_{O,max}$	—	—	470	$\mu F$
Output Current	5V	$I_O$	0		4.0	A <sub>dc</sub>
	3.3V	$I_O$	0		5.0	A <sub>dc</sub>
	2.5V, 2.0, 1.8V, 1.5V, 1.2V, 1.0V	$I_O$	0		6.0	A <sub>dc</sub>
Output Current Limit Inception ( Hiccup Mode )	5V	$I_{O,lim}$	—	6.5	—	A <sub>dc</sub>
	3.3V	$I_{O,lim}$	—	7	—	A <sub>dc</sub>
	2.5V, 2.0V, 1.8V, 1.5V, 1.2V, 1.0V	$I_{O,lim}$	—	8.5	—	A <sub>dc</sub>
Output Short-Circuit Current ( $V_O \leq 250mV$ ) ( Hiccup Mode )	5V	$I_{O,s/c}$	—	2.4	—	A <sub>rms</sub>
	3.3V	$I_{O,s/c}$	—	2.4	—	A <sub>rms</sub>
	2.5V, 2.0V, 1.8V, 1.5V, 1.2V, 1.0V	$I_{O,s/c}$	—	2.8	—	A <sub>rms</sub>

HW006/010/012 Series Power Modules; dc-dc Converters  
 36-75Vdc Input; 1.2 Vdc to 5 Vdc Output; 6.6A to 12A

Electrical Specifications (continued)

Parameter	Device	Symbol	Min	Typ	Max	Unit
Efficiency $V_{IN}=V_{IN,nom}$ , $T_A=25^\circ C$ $I_o=I_{o,max}$ , $V_o=V_{o,set}$	HW 5V	$\eta$	—	89.0	—	%
	HW 3.3V	$\eta$	—	87.0	—	%
	HW 2.5V	$\eta$	—	86.0	—	%
	HW 2.0V	$\eta$	—	82.0	—	%
	HW 1.8V	$\eta$	—	82.0	—	%
	HW 1.5V	$\eta$	—	80.0	—	%
	HW 1.2V	$\eta$	—	77.0	—	%
	HW 1.0V	$\eta$	—	75.0	—	%
	HC 5V	$\eta$	—	88.0	—	%
	HC 3.3V	$\eta$	—	86.0	—	%
Switching Frequency	All HW	$f_{sw}$	—	300	—	kHz
	All HC	$f_{sw}$	—	380	—	kHz
Dynamic Load Response $(\Delta I_o/\Delta t=1A/\mu s; V_{in}=V_{in,nom}; T_A=25^\circ C)$  Load Change from $I_o=50\%$ to $75\%$ of $I_{o,max}$ :  Peak Deviation Settling Time ( $V_o<10\%$ peak deviation)	5V, 3.3V	$V_{pk}$	—	100	—	mV
	2.5V, 2.0V, 1.8V, 1.5V, 1.2V, 1.0V	$V_{pk}$	—	80	—	mV
	All	$t_s$	—	100	—	$\mu s$
Dynamic Line Response $(\Delta V_{in} / \Delta t \leq 0.5V/\mu s; V_{in}=V_{in,nom}; T_A=25^\circ C)$  Peak Deviation Settling Time ( $V_o<10\%$ peak deviation)	All	$V_{pk}$	—	0.6	2	% $V_o, set$
	All	$t_s$	—	150	1000	$\mu s$

Isolation Specifications

Parameter	Symbol	Min	Typ	Max	Unit
Isolation Capacitance	$C_{iso}$	—	200	—	pF
Isolation Resistance	$R_{iso}$	10	—	—	M $\Omega$

General Specifications

Parameter	Min	Typ	Max	Unit
Calculated MTBF (for HW005A0F1-S in accordance with Lucent RIN 6: $I_o=80\%$ of $I_{o,max}$ , $T_A=25^\circ C$ , airflow=1m/s)	>4,000,000			Hours
Weight	—	13	—	g (oz.)

# HW006/010/012 Series Power Modules; dc-dc Converters

## 36-75Vdc Input; 1.2 Vdc to 5 Vdc Output; 6.6A to 12A

### Feature Specifications

Unless otherwise indicated, specifications apply over all operating input voltage, resistive load, and temperature conditions. See Feature Descriptions for additional information.

Parameter	Device	Symbol	Min	Typ	Max	Unit
<b>Remote On/Off Signal Interface</b> ( $V_{IN}=V_{IN, min}$ to $V_{IN, max}$ ; open collector or equivalent, Signal referenced to $V_{IN}$ -terminal) Negative Logic: device code suffix "1" Logic Low = module On, Logic High = module Off Positive Logic: No device code suffix required Logic Low = module Off, Logic High = module On Logic Low Specification Remote On/Off Current - Logic Low On/Off Voltage: Logic Low Logic High - (Typ = Open Collector) Logic High maximum allowable leakage current	All	$I_{on/off}$	—	0.15	1.0	mA
<b>Turn-On Delay and Rise Times</b> ( $I_O=I_{O, max}$ )  $T_{delay}$ = Time until $V_O = 10\%$ of $V_{O, set}$ from either application of $V_{in}$ with Remote On/Off set to On or operation of Remote On/Off from Off to On with $V_{in}$ already applied for at least one second.  $T_{rise}$ = time for $V_O$ to rise from 10% of $V_{O, set}$ to 90% of $V_{O, set}$ .	5V, 3.3V	$T_{delay}$	—	100	—	ms
		$T_{rise}$	—	40	—	ms
	2.5V, 2.0V, 1.8V, 1.5V, 1.2V, 1.0V	$T_{delay}$	—	12	—	ms
		$T_{rise}$	—	3	—	ms
<b>Output Overvoltage Protection#</b>  Values are the same for HW and HC codes	5V	$V_{O, limit}$	—	—	7.0	V
	3.3V		—	—	4.6	V
	2.5V		—	—	3.5	V
	2.0V		—	—	3.2	V
	1.8V		—	—	2.8	V
	1.5V		—	—	2.5	V
	1.2V		—	—	2.0	V
	1.0V		—	—	1.8	V
<b>Overtemperature Protection</b> (See Feature Descriptions)	All	$T_{ref}$	—	125	—	°C
<b>Input Undervoltage Lockout</b> Turn-on Threshold Turn-off Threshold Turn-on Threshold Turn-off Threshold	All HW		—	33	36	V
	All HW		27	30	—	V
	All HC		—	17	18	V
	All HC		13.5	15	—	V

# More accurate Overvoltage protection can be accomplished externally by means of the remote On/Off pin.

# HW006/010/012 Series Power Modules; dc-dc Converters

36-75Vdc Input; 1.2 Vdc to 5 Vdc Output; 6.6A to 12A

## Characteristic Curves

The following figures provide typical characteristics for the HW004A0A (5.0V, 4A) at 25°C. The figures are identical for either positive or negative Remote On/Off logic.

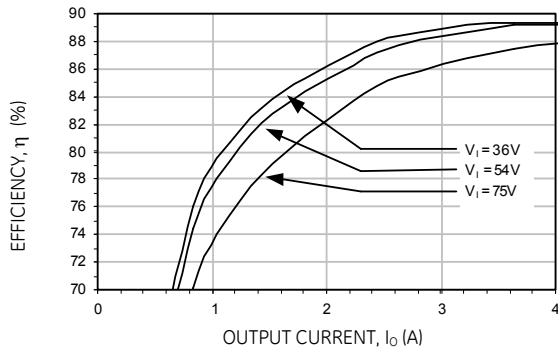

Figure 1. Converter Efficiency versus Output Current

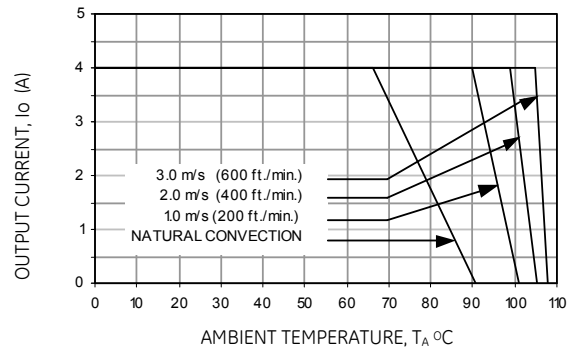

Figure 4. Derating Output Current versus Local Ambient Temperature and Airflow

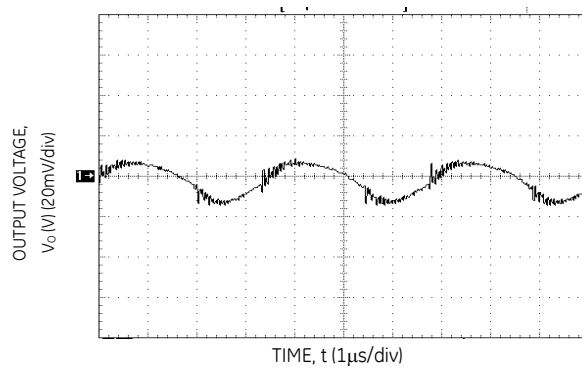

Figure 2. Typical Output Ripple and Noise.

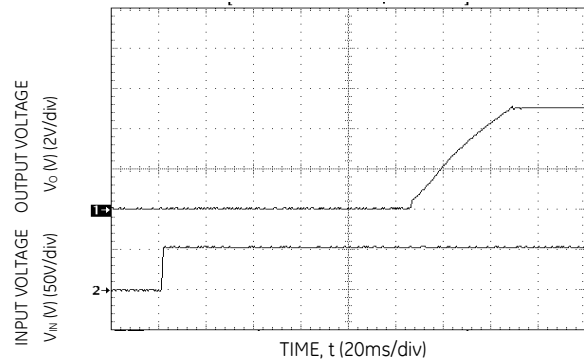

Figure 5. Typical Start-Up with application of Vin.

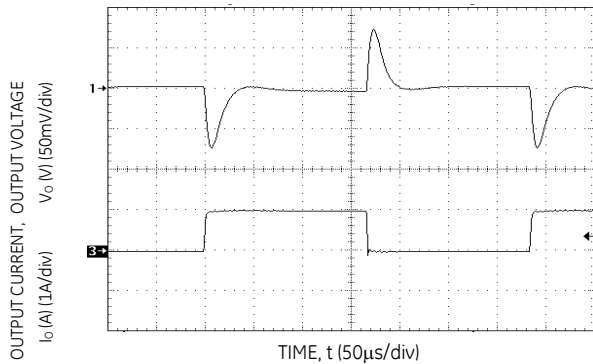

Figure 3. Transient Response to Dynamic Load Change from 50% to 75% to 50% of full load.

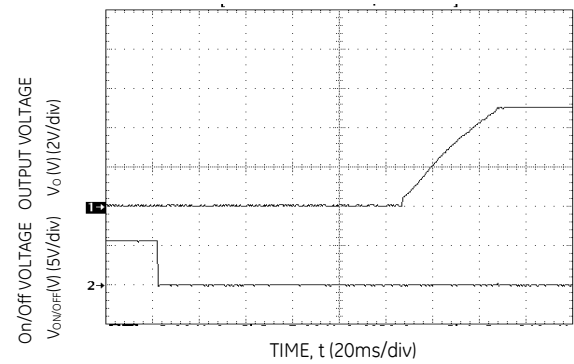

Figure 6. Typical Start-Up Using Remote On/Off, negative logic version shown.

# HW006/010/012 Series Power Modules; dc-dc Converters

36-75Vdc Input; 1.2 Vdc to 5 Vdc Output; 6.6A to 12A

## Characteristic Curves (continued)

The following figures provide typical characteristics for the HW005A0F (3.3V, 5A) at 25°C. The figures are identical for either positive or negative Remote On/Off logic.

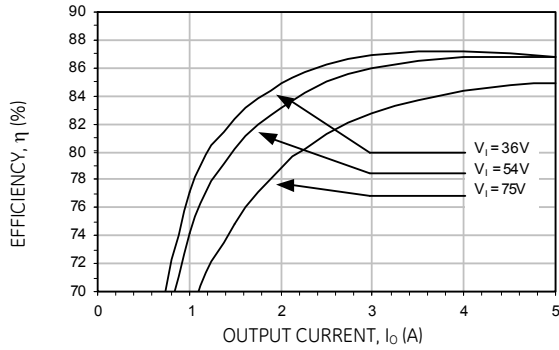

Figure 7. Converter Efficiency versus Output Current

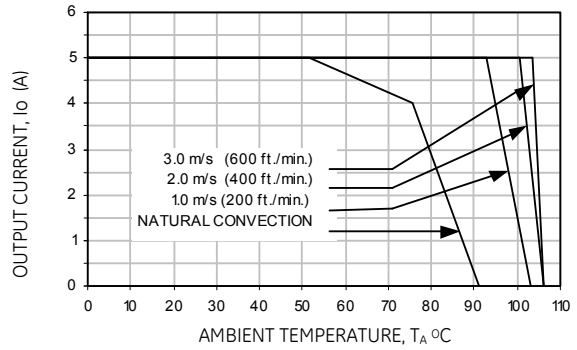

Figure 10. Derating Output Current versus Local Ambient Temperature and Airflow

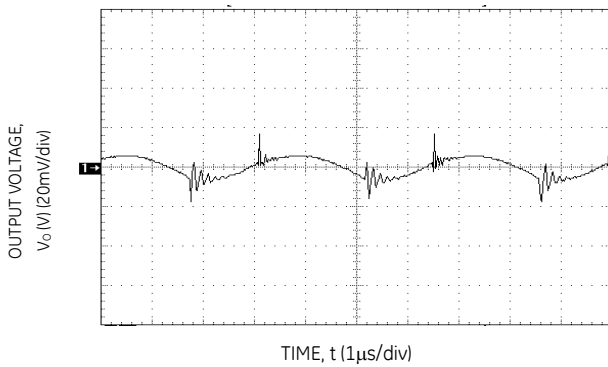

Figure 8. Typical Output Ripple and Noise.

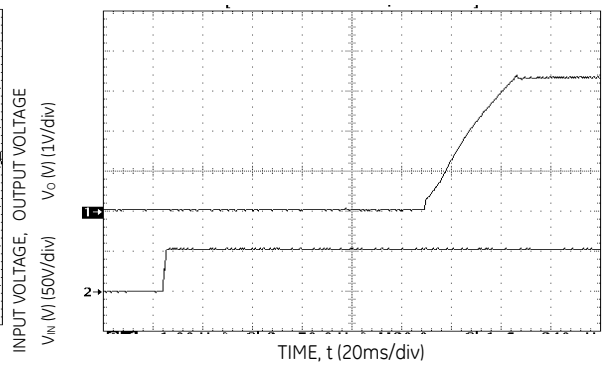

Figure 11. Typical Start-Up with application of Vin.

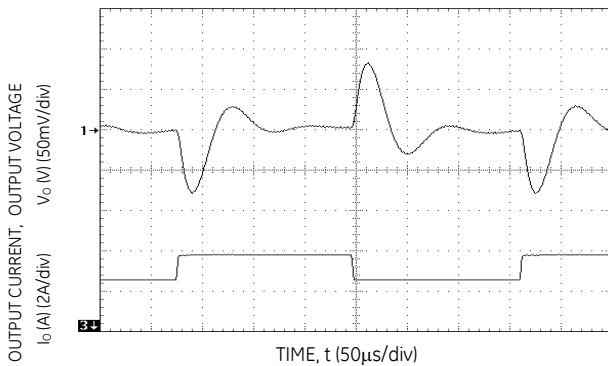

Figure 9. Transient Response to Dynamic Load Change from 50% to 75% to 50% of full load.

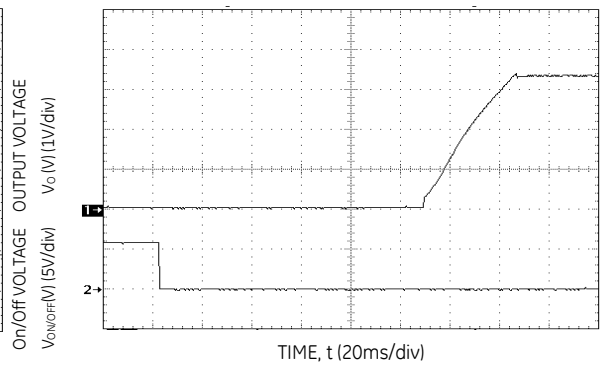

Figure 12. Typical Start-Up Using Remote On/Off, negative logic version shown.

# HW006/010/012 Series Power Modules; dc-dc Converters

36-75Vdc Input; 1.2 Vdc to 5 Vdc Output; 6.6A to 12A

## Characteristic Curves (continued)

The following figures provide typical characteristics for the HW006A0G (2.5V, 6A) at 25°C. The figures are identical for either positive or negative Remote On/Off logic.

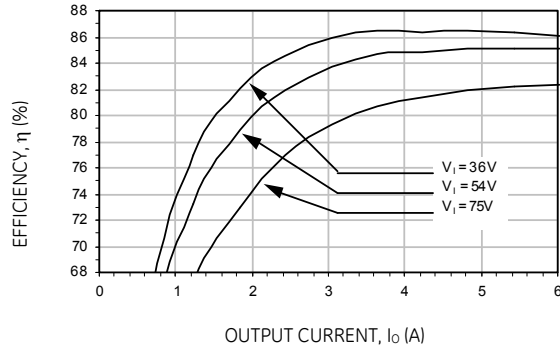

Figure 13. Converter Efficiency versus Output Current.

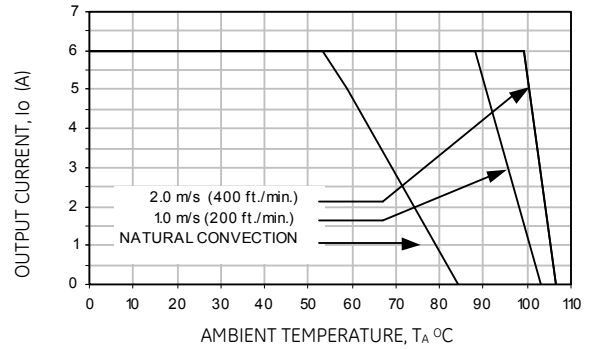

Figure 16. Derating Output Current versus Local Ambient Temperature and Airflow.

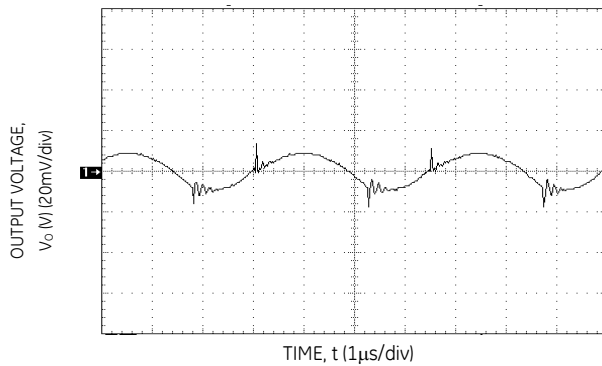

Figure 14. Typical Output Ripple and Noise.

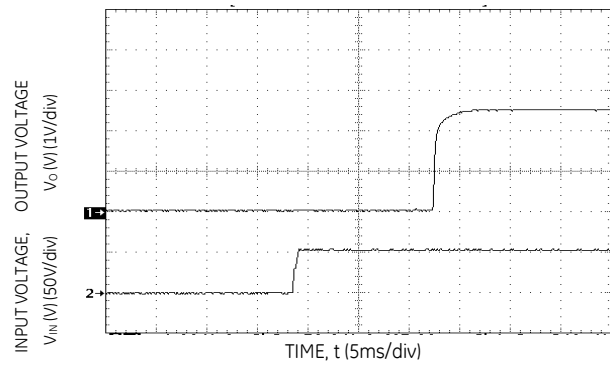

Figure 17. Typical Start-Up with application of Vin.

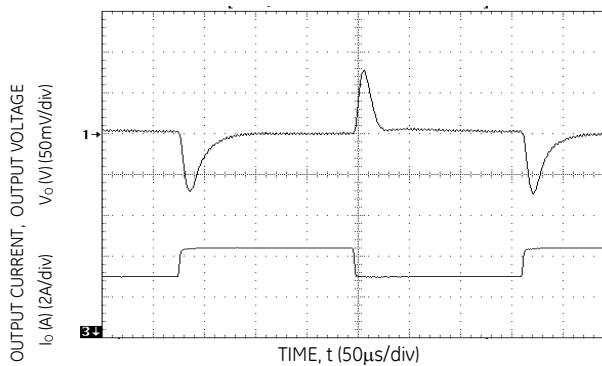

Figure 15. Transient Response to Dynamic Load Change from 50% to 75% to 50% of full load.

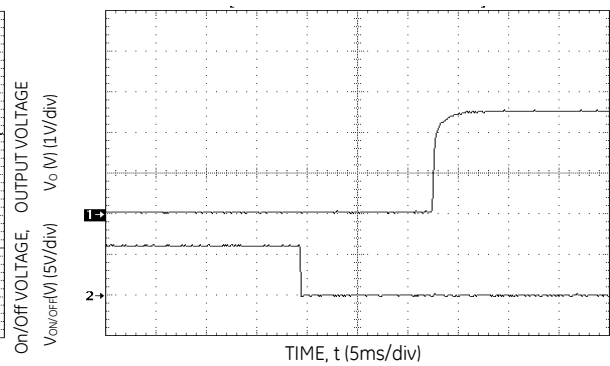

Figure 18. Typical Start-Up Using Remote On/Off, negative logic version shown.

# HW006/010/012 Series Power Modules; dc-dc Converters

36-75Vdc Input; 1.2 Vdc to 5 Vdc Output; 6.6A to 12A

## Characteristic Curves (continued)

The following figures provide typical characteristics for the HW006A0D (2.0V, 6A) at 25°C. The figures are identical for either positive or negative Remote On/Off logic.

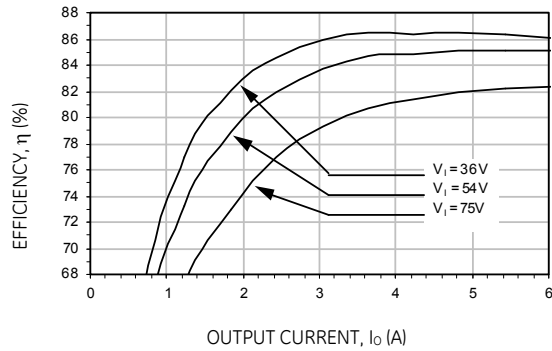

Figure 13. Converter Efficiency versus Output Current.

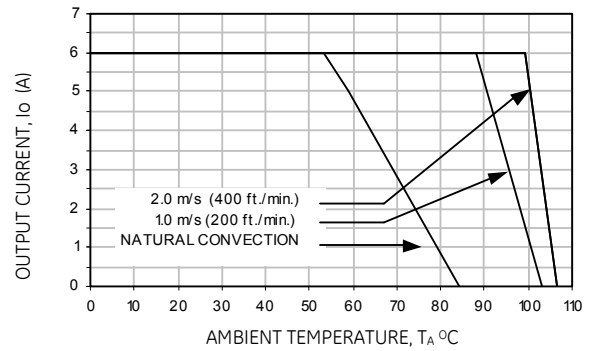

Figure 16. Derating Output Current versus Local Ambient Temperature and Airflow

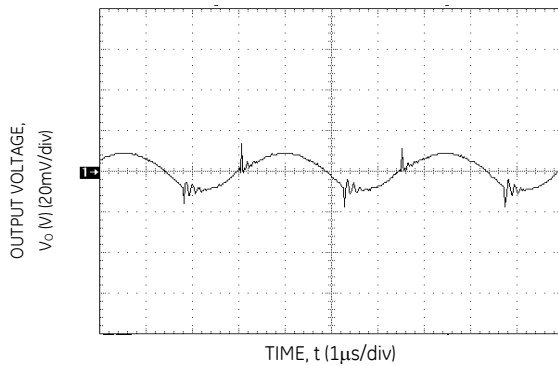

Figure 14. Typical Output Ripple and Noise.

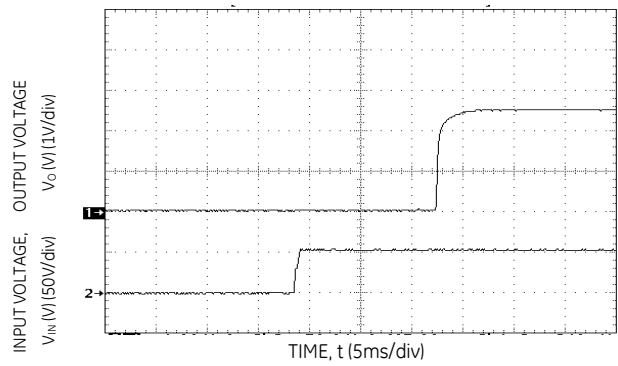

Figure 17. Typical Start-Up with application of Vin.

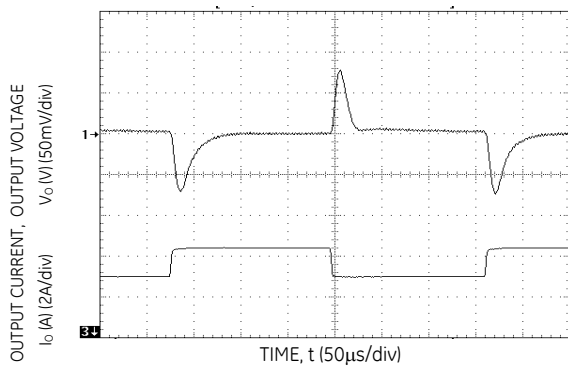

Figure 15. Transient Response to Dynamic Load Change from 50% to 75% to 50% of full load.

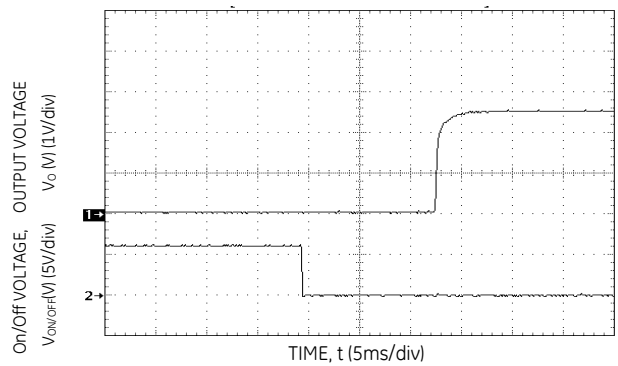

Figure 18. Typical Start-Up Using Remote On/Off, negative logic version shown.

# HW006/010/012 Series Power Modules; dc-dc Converters

36-75Vdc Input; 1.2 Vdc to 5 Vdc Output; 6.6A to 12A

## Characteristic Curves (continued)

The following figures provide typical characteristics for the HW006A0Y (1.8V, 6A) at 25°C. The figures are identical for either positive or negative Remote On/Off logic.

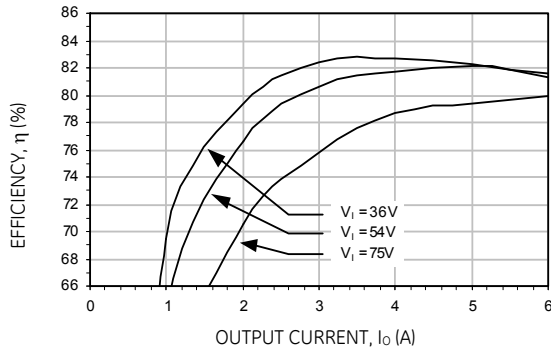

Figure 25. Converter Efficiency versus Output Current

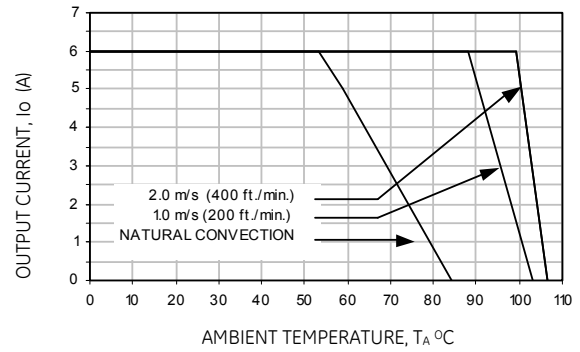

Figure 28. Derating Output Current versus Local Ambient Temperature and Airflow

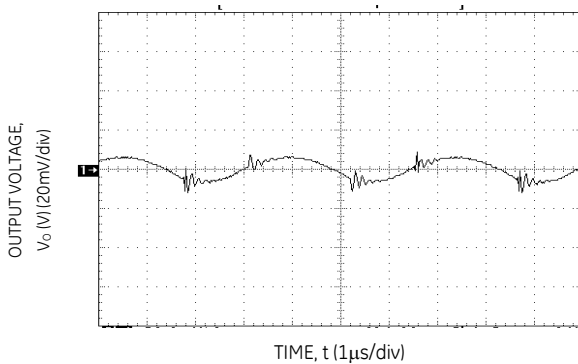

Figure 26. Typical Output Ripple and Noise.

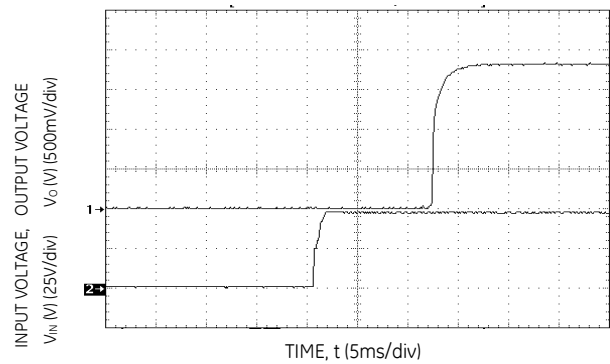

Figure 29. Typical Start-Up with application of Vin.

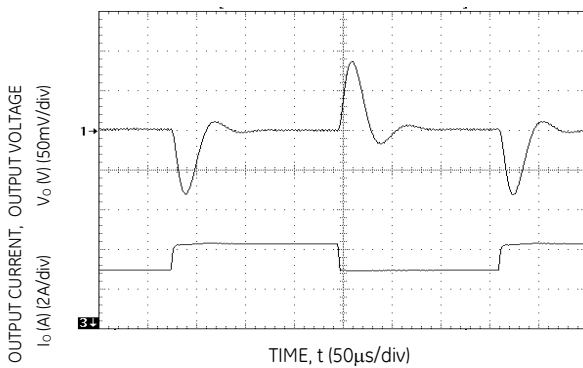

Figure 27. Transient Response to Dynamic Load Change from 50% to 75% to 50% of full load.

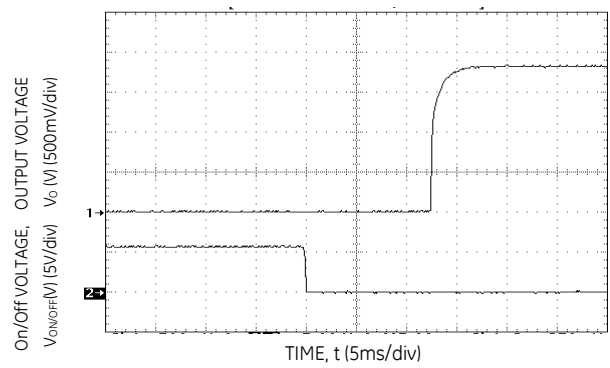

Figure 30. Typical Start-Up Using Remote On/Off, negative logic version shown.

# HW006/010/012 Series Power Modules; dc-dc Converters

36-75Vdc Input; 1.2 Vdc to 5 Vdc Output; 6.6A to 12A

## Characteristic Curves (continued)

The following figures provide typical characteristics for the HW006A0M (1.5V, 6A) at 25°C. The figures are identical for either positive or negative Remote On/Off logic.

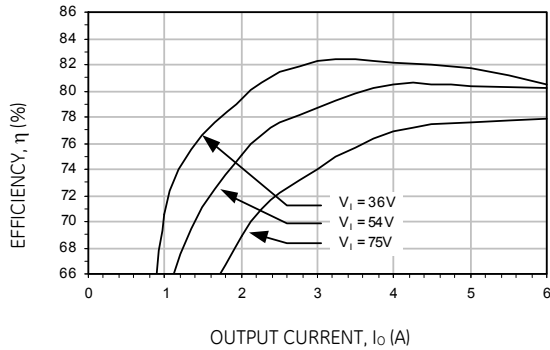

Figure 31. Converter Efficiency versus Output Current.

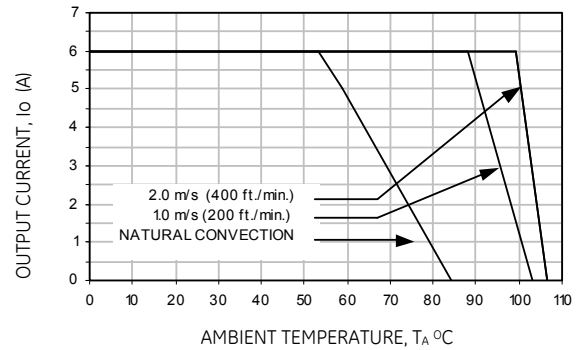

Figure 34. Derating Output Current versus Local Ambient Temperature and Airflow

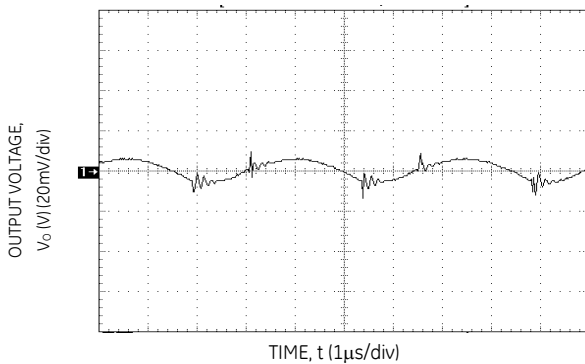

Figure 32. Typical Output Ripple and Noise.

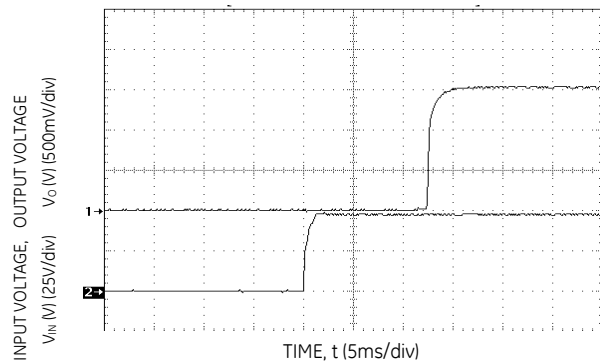

Figure 35. Typical Start-Up with application of Vin.

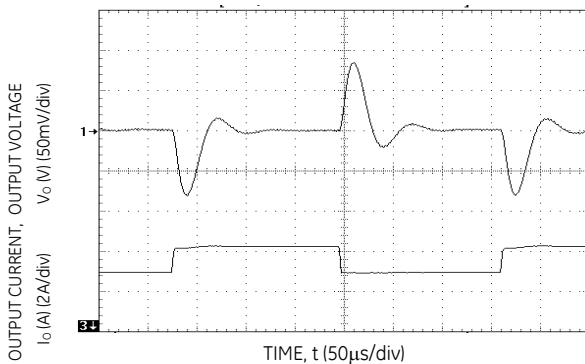

Figure 33. Transient Response to Dynamic Load Change from 50% to 75% to 50% of full load.

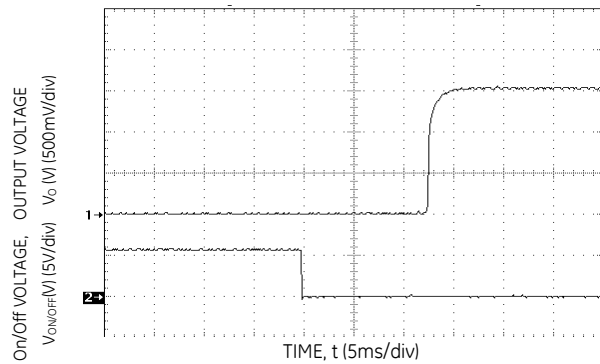

Figure 36. Typical Start-Up Using Remote On/Off, negative logic version shown.

# HW006/010/012 Series Power Modules; dc-dc Converters

36-75Vdc Input; 1.2 Vdc to 5 Vdc Output; 6.6A to 12A

## Characteristic Curves (continued)

The following figures provide typical characteristics for the HW006A0P (1.2V, 6A) at 25°C. The figures are identical for either positive or negative Remote On/Off logic.

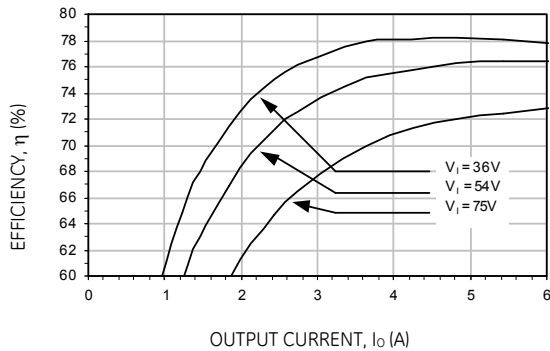

Figure 37. Converter Efficiency versus Output Current.

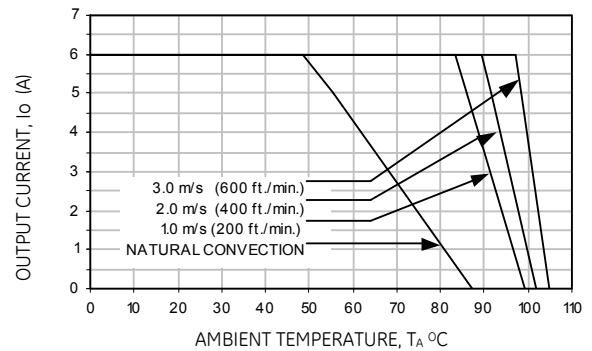

Figure 40. Derating Output Current versus Local Ambient Temperature and Airflow

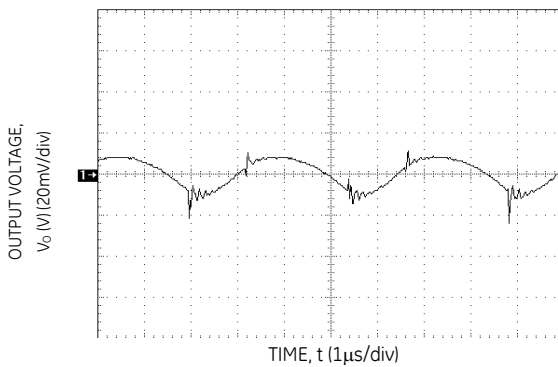

Figure 38. Typical Output Ripple and Noise.

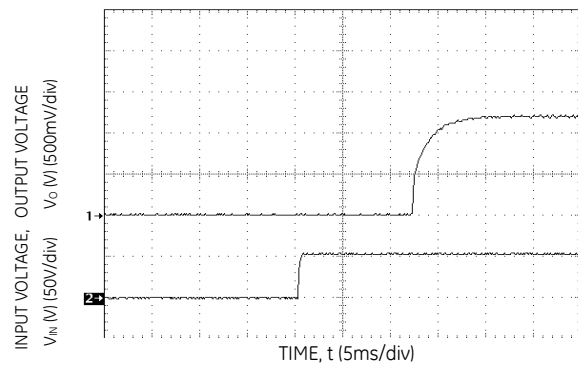

Figure 41. Typical Start-Up with application of Vin.

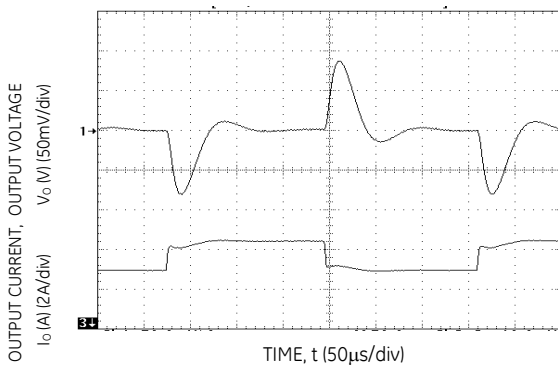

Figure 39. Transient Response to Dynamic Load Change from 50% to 75% to 50% of full load.

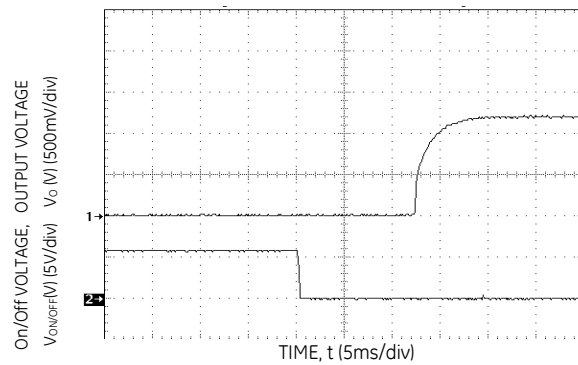

Figure 42. Typical Start-Up Using Remote On/Off, negative logic version shown.

# HW006/010/012 Series Power Modules; dc-dc Converters

36-75Vdc Input; 1.2 Vdc to 5 Vdc Output; 6.6A to 12A

## Characteristic Curves (continued)

The following figures provide typical characteristics for the HW006A0S1R0 (1.0V, 6A) at 25°C. The figures are identical for either positive or negative Remote On/Off logic.

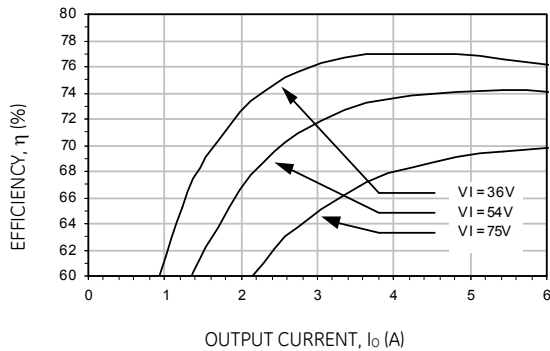

Figure 43. Converter Efficiency versus Output Current.

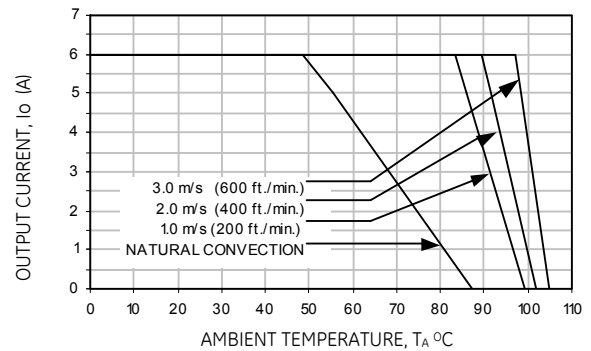

Figure 46. Derating Output Current versus Local Ambient Temperature and Airflow.

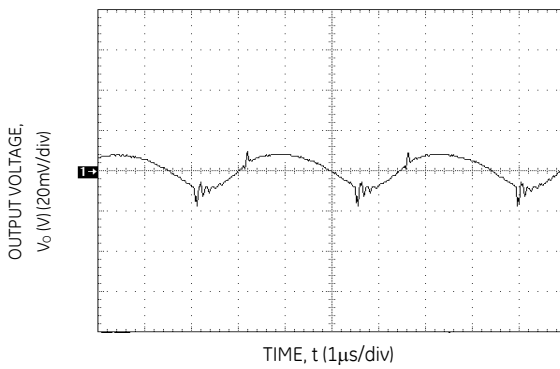

Figure 44. Typical Output Ripple and Noise.

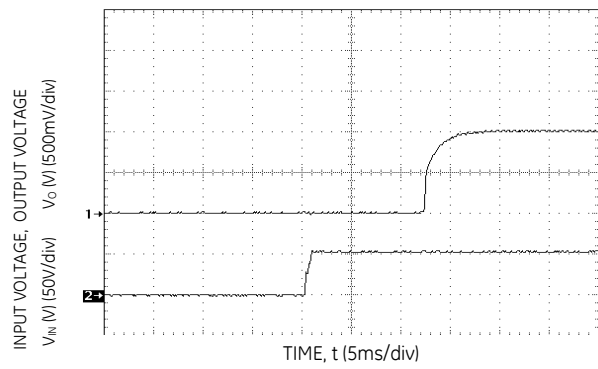

Figure 47. Typical Start-Up with application of  $V_{in}$ .

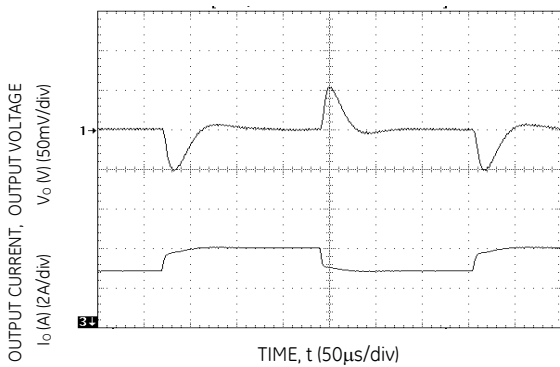

Figure 45. Transient Response to Dynamic Load Change from 50% to 75% to 50% of full load.

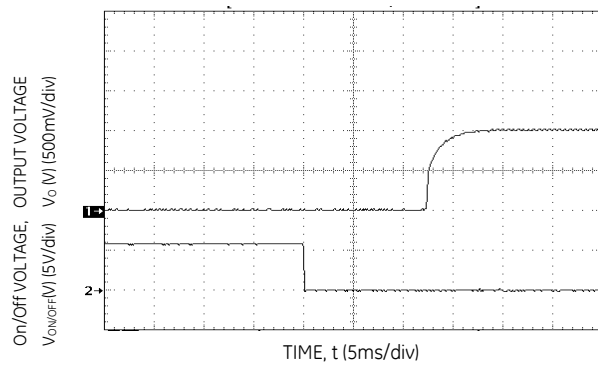

Figure 48. Typical Start-Up Using Remote On/Off, negative logic version shown.

# HW006/010/012 Series Power Modules; dc-dc Converters

36-75Vdc Input; 1.2 Vdc to 5 Vdc Output; 6.6A to 12A

## Characteristic Curves (continued)

The following figures provide typical characteristics for the HC004A0A (5.0V, 4A) at 25°C. The figures are identical for either positive or negative Remote On/Off logic.

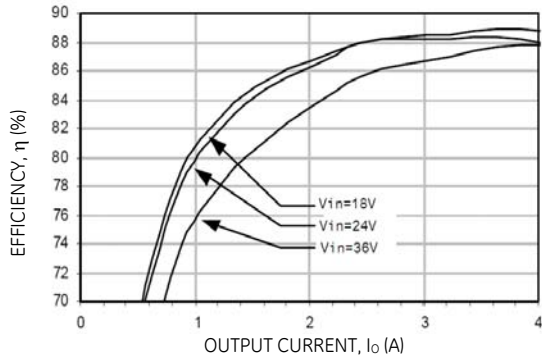

Figure 49. Converter Efficiency versus Output Current.

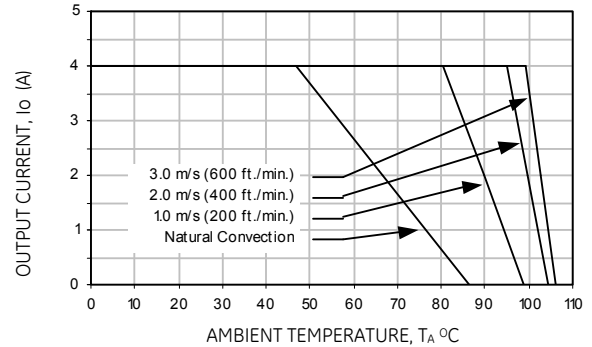

Figure 52. Derating Output Current versus Local Ambient Temperature and Airflow.

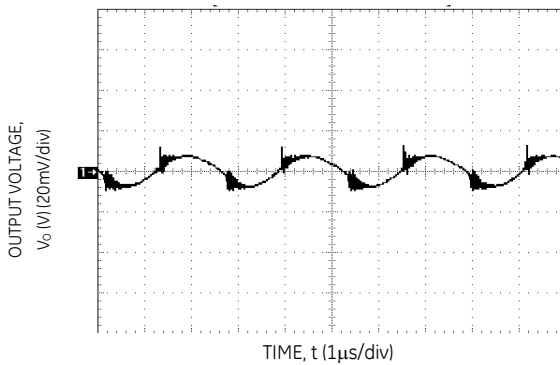

Figure 50. Typical Output Ripple and Noise.

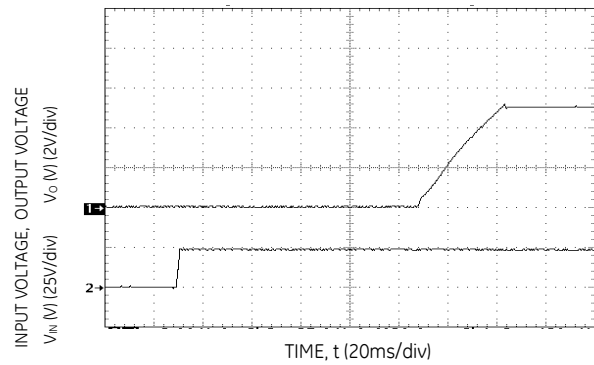

Figure 53. Typical Start-Up with application of Vin.

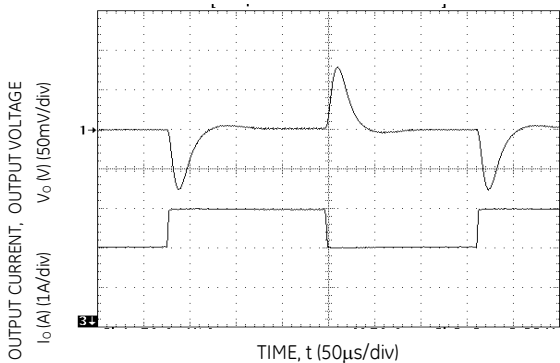

Figure 51. Transient Response to Dynamic Load Change from 50% to 75% to 50% of full load.

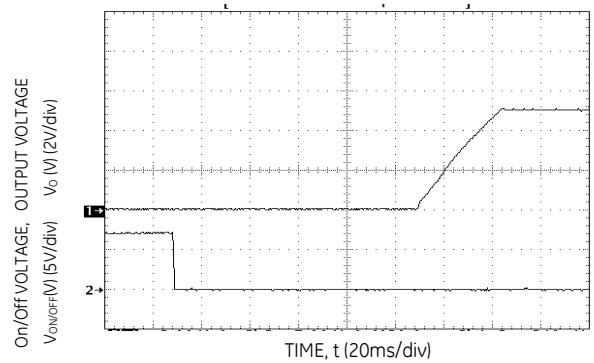

Figure 54. Typical Start-Up Using Remote On/Off, negative logic version shown.

# HW006/010/012 Series Power Modules; dc-dc Converters

36-75Vdc Input; 1.2 Vdc to 5 Vdc Output; 6.6A to 12A

## Characteristic Curves (continued)

The following figures provide typical characteristics for the HC005A0F (3.3V, 5A) at 25°C. The figures are identical for either positive or negative Remote On/Off logic.

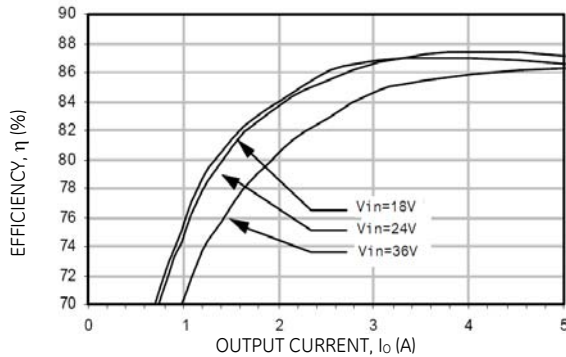

Figure 55. Converter Efficiency versus Output Current.

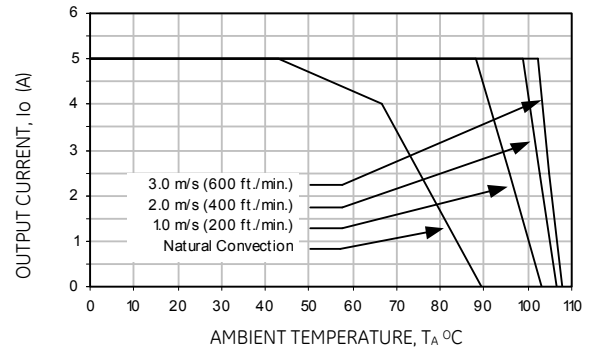

Figure 58. Derating Output Current versus Local Ambient Temperature and Airflow.

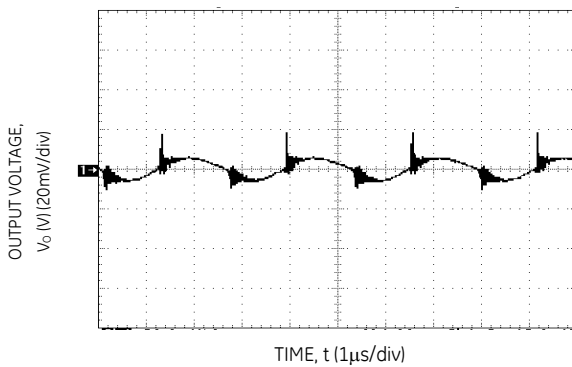

Figure 56. Typical Output Ripple and Noise.

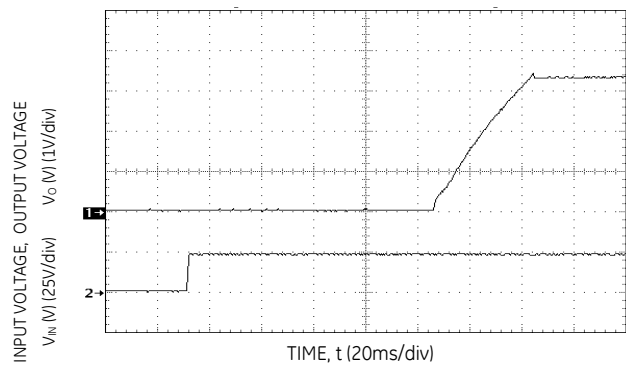

Figure 59. Typical Start-Up with application of Vin.

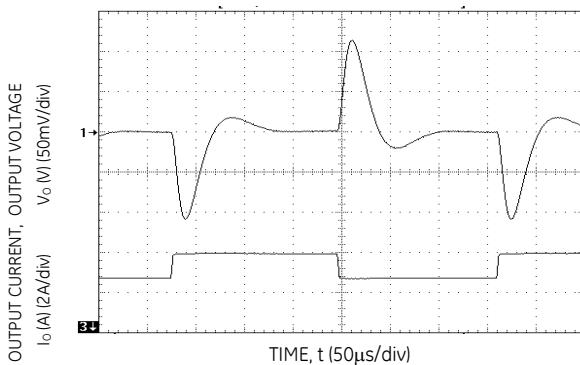

Figure 57. Transient Response to Dynamic Load Change from 50% to 75% to 50% of full load.

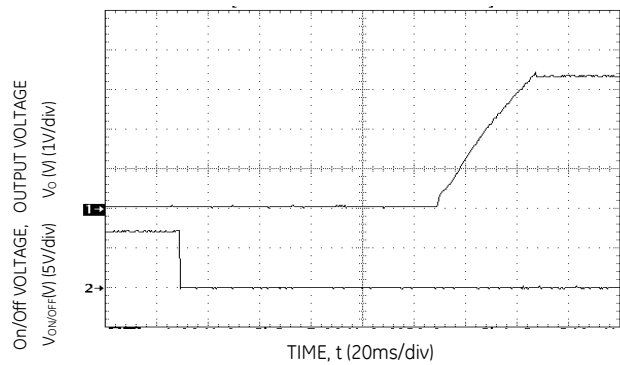
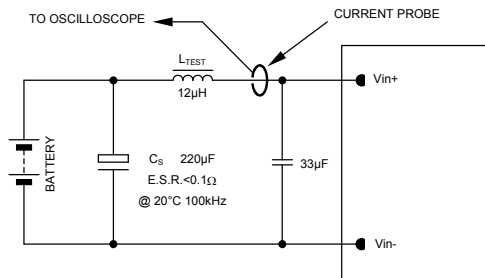

Figure 60. Typical Start-Up Using Remote On/Off, negative logic version shown.

# HW006/010/012 Series Power Modules; dc-dc Converters

36-75Vdc Input; 1.2 Vdc to 5 Vdc Output; 6.6A to 12A

## Test Configurations



NOTE: Measure input reflected ripple current with a simulated source inductance ( $L_{TEST}$ ) of 12µH. Capacitor  $C_S$  offsets possible battery impedance. Measure current as shown above.

Figure 61. Input Reflected Ripple Current Test Setup.

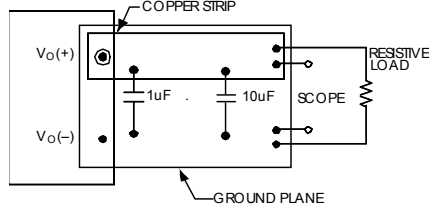

NOTE: All voltage measurements to be taken at the module terminals, as shown above. If sockets are used then Kelvin connections are required at the module terminals to avoid measurement errors due to socket contact resistance.

Figure 62. Output Ripple and Noise Test Setup.

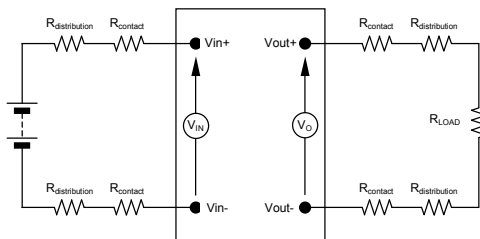

NOTE: All voltage measurements to be taken at the module terminals, as shown above. If sockets are used then Kelvin connections are required at the module terminals to avoid measurement errors due to socket contact resistance.

Figure 63. Output Voltage and Efficiency Test Setup.

$$\text{Efficiency } \eta = \frac{V_O \cdot I_O}{V_{IN} \cdot I_{IN}} \times 100 \%$$

## Design Considerations

### Input Source Impedance

The power module should be connected to a low ac-impedance source. A highly inductive source impedance can affect the stability of the power module. For the test configuration in Figure 61, a 33µF electrolytic capacitor (ESR<0.7Ω at 100kHz), mounted close to the power module helps ensure the stability of the unit. Consult the factory for further application guidelines.

### Safety Considerations

For safety-agency approval of the system in which the power module is used, the power module must be installed in compliance with the spacing and separation requirements of the end-use safety agency standard, i.e., UL 60950-1-3, CSA C22.2 No. 60950-00, and VDE 0805:2001-12 (IEC60950-1).

If the input source is non-SELV (ELV or a hazardous voltage greater than 60 Vdc and less than or equal to 75Vdc), for the module's output to be considered as meeting the requirements for safety extra-low voltage (SELV), all of the following must be true:

- The input source is to be provided with reinforced insulation from any other hazardous voltages, including the ac mains.
- One  $V_{IN}$  pin and one  $V_{OUT}$  pin are to be grounded, or both the input and output pins are to be kept floating.
- The input pins of the module are not operator accessible.
- Another SELV reliability test is conducted on the whole system (combination of supply source and subject module), as required by the safety agencies, to verify that under a single fault, hazardous voltages do not appear at the module's output.

**Note:** Do not ground either of the input pins of the module without grounding one of the output pins. This may allow a non-SELV voltage to appear between the output pins and ground.

The power module has extra-low voltage (ELV) outputs when all inputs are ELV.

For input voltages exceeding -60 Vdc but less than or equal to -75 Vdc, these converters have been evaluated to the applicable requirements of BASIC INSULATION between secondary DC MAINS DISTRIBUTION input (classified as TNV-2 in Europe) and unearthed SELV outputs.

"All flammable materials used in the manufacturing of these modules are rated 94V-0 and UL60950 A.2 for reduced thicknesses.

The input to these units is to be provided with a maximum 3A fast-acting fuse in the unearthed lead."

## Feature Description

### Remote On/Off

Two remote on/off options are available. Positive logic turns the module on during a logic high voltage on the ON/OFF

# HW006/010/012 Series Power Modules; dc-dc Converters

## 36-75Vdc Input; 1.2 Vdc to 5 Vdc Output; 6.6A to 12A

pin, and off during a logic low. Negative logic remote On/Off, device code suffix "1", turns the module off during a logic high and on during a logic low.

To maintain compatibility with LW series power modules the Remote On/Off pin is optional for the TH (through hole) version. Standard TH modules have no On/Off pin fitted. TH modules ordered with device code suffix "1" are negative logic with the On/Off pin fitted.

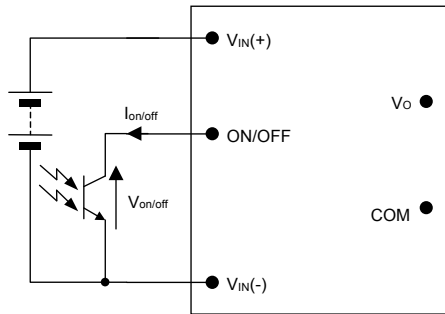

**Figure 64. Remote On/Off Implementation.**

To turn the power module on and off, the user must supply a switch (open collector or equivalent) to control the voltage ( $V_{on/off}$ ) between the ON/OFF terminal and the  $V_{IN(-)}$  terminal. Logic low is  $0V \leq V_{on/off} \leq 1.2V$ . The maximum  $I_{on/off}$  during a logic low is 1mA, the switch should be maintain a logic low level whilst sinking this current.

During a logic high, the typical  $V_{on/off}$  generated by the module is 5.8V, and the maximum allowable leakage current at  $V_{on/off} = 5.8V$  is 10 $\mu$ A.

If not using the remote on/off feature:

For positive logic, leave the ON/OFF pin open.

For negative logic, short the ON/OFF pin to  $V_{IN(-)}$ .

### Overcurrent Protection

To provide protection in a fault (output overload) condition, the unit is equipped with internal current-limiting circuitry and can endure current limiting continuously. At the point of current-limit inception, the unit enters hiccup mode. The unit operates normally once the output current is brought back into its specified range. The average output current during hiccup is 10%  $I_{o, max}$ .

### Input Undervoltage Lockout

At input voltages below the input undervoltage lockout limit, the module operation is disabled. The module will only begin to operate once the input voltage is raised above the undervoltage lockout turn-on threshold,  $V_{UV/ON}$ .

Once operating, the module will continue to operate until the input voltage is taken below the undervoltage turn-off threshold,  $V_{UV/OFF}$ .

### Over Voltage Protection

The output overvoltage protection consists of circuitry that internally clamps the output voltage. If a more accurate output overvoltage protection scheme is required then this should be implemented externally via use of the remote on/off pin.

### Over Temperature Protection

To provide protection in a fault condition, the unit is equipped with a thermal shutdown circuit. The unit will shutdown if the overtemperature threshold of 125 °C is exceeded at the thermal reference point  $T_{ref}$ . Once the unit goes into thermal shutdown it will then wait to cool before attempting to restart.

### Output Voltage Programming

Trimming allows the output voltage set point to be increased or decreased, this is accomplished by connecting an external resistor between the TRIM pin and either the  $V_{O(+)}$  pin or the  $V_{O(-)}$  pin (COM pin).

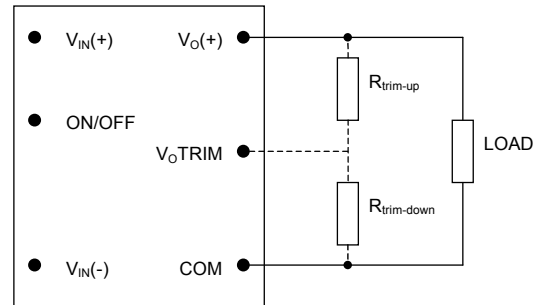

**Figure 65. Circuit Configuration to Trim Output Voltage.**

Connecting an external resistor ( $R_{trim-down}$ ) between the TRIM pin and the COM pin decreases the output voltage set point. To maintain set point accuracy, the trim resistor tolerance should be  $\pm 0.1\%$ .

## HW006/010/012 Series Power Modules; dc-dc Converters

### 36-75Vdc Input; 1.2 Vdc to 5 Vdc Output; 6.6A to 12A

#### Feature Descriptions (continued)

The relationship between the output voltage and the trim resistor value for a  $\Delta\%$  reduction in output voltage is:

Nominal 5V, 3.3V, 2.5V, 2.0V, 1.8V, & 1.5V modules:

$$R_{\text{trim-down}} = \left[ \frac{511}{\Delta\%} - 6.11 \right] \text{ k}\Omega$$

Nominal 1.2V module:

$$R_{\text{trim-down}} = \left[ \frac{346}{\Delta\%} - 4.46 \right] \text{ k}\Omega$$

Nominal 1.0V module:

$$R_{\text{trim-down}} = \left[ \frac{390}{\Delta\%} - 4.90 \right] \text{ k}\Omega$$

Connecting an external resistor ( $R_{\text{trim-up}}$ ) between the TRIM pin and the  $V_o(+)$  pin increases the output voltage set point. To maintain set point accuracy, the trim resistor tolerance should be  $\pm 0.5\%$ .

The relationship between the output voltage and the trim resistor value for a  $\Delta\%$  increase in output voltage is:

Nominal 5V, 3.3V, 2.5V, 2.0V, 1.8V, & 1.5V modules:

$$R_{\text{trim-up}} = \left[ \frac{5.11V_o(100+\Delta\%)}{1.225\Delta\%} - \frac{511}{\Delta\%} - 6.11 \right] \text{ k}\Omega$$

Nominal 1.2V module:

$$R_{\text{trim-up}} = \left[ \frac{5.11V_o(100+\Delta\%)}{1.225\Delta\%} - \frac{346}{\Delta\%} - 4.46 \right] \text{ k}\Omega$$

Nominal 1.0V module:

$$R_{\text{trim-up}} = \left[ \frac{5.11V_o(100+\Delta\%)}{1.225\Delta\%} - \frac{390}{\Delta\%} - 4.90 \right] \text{ k}\Omega$$

( $V_o$  refers to the nominal output voltage, i.e. 5.0V for  $V_o$  on an HW004A0A.  $\Delta\%$  is the required % change in output voltage, i.e. to trim a 5.0V module to 5.10V the  $\Delta\%$  value is 2).

Examples:

To trim down the output of a nominal 5.0V module (HW004A0A) to 4.90V

$$\Delta\% = 2$$

$$R_{\text{trim-down}} = \left[ \frac{511}{2} - 6.11 \right] \text{ k}\Omega$$

$$R_{\text{trim-down}} = 249.39 \text{ k}\Omega$$

To trim up the output of a nominal 3.3V module (HW005A0F) to 3.63V

$$\Delta\% = 10$$

$$R_{\text{trim-up}} = \left[ \frac{5.11 \times 3.3(100+10)}{1.225 \times 10} - \frac{511}{10} - 6.11 \right] \text{ k}\Omega$$

$$R_{\text{trim-up}} = 94.2 \text{ k}\Omega$$

# HW006/010/012 Series Power Modules; dc-dc Converters

36-75Vdc Input; 1.2 Vdc to 5 Vdc Output; 6.6A to 12A

## Thermal Considerations

The power modules operate in a variety of thermal environments; however, sufficient cooling should be provided to help ensure reliable operation.

Considerations include ambient temperature, airflow, module power dissipation, and the need for increased reliability. A reduction in the operating temperature of the module will result in an increase in reliability. The thermal data presented here is based on physical measurements taken in a wind tunnel.

The thermal reference point,  $T_{ref}$  used in the specifications is shown in Figure 66. For reliable operation this temperature should not exceed 115 °C.

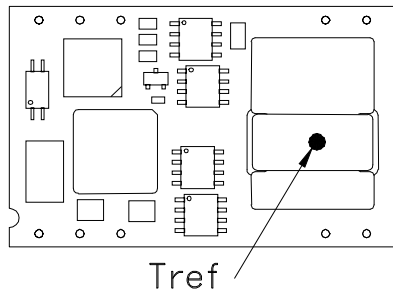

Figure 66.  $T_{ref}$  Temperature Measurement Location.

Please refer to the Application Note “Thermal Characterization Process For Open-Frame Board-Mounted Power Modules” for a detailed discussion of thermal aspects including maximum device temperatures.

## Heat Transfer via Convection

Increased airflow over the module enhances the heat transfer via convection. Derating figures showing the maximum output current that can be delivered by each module versus local ambient temperature ( $T_A$ ) for natural convection and up to 3m/s (600 ft./min) are shown in the respective Characteristics Curves section.

## EMC Considerations

The figure 67 shows a suggested configuration to meet the conducted emission limits of EN55022 Class B.

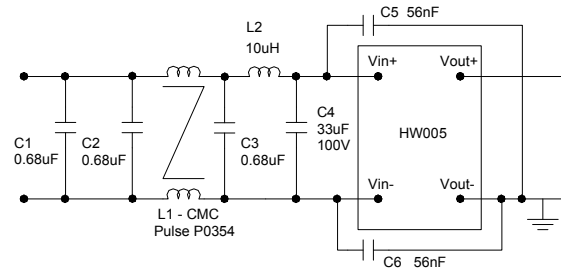

Figure 67. Suggested Configuration for EN55022 Class B.

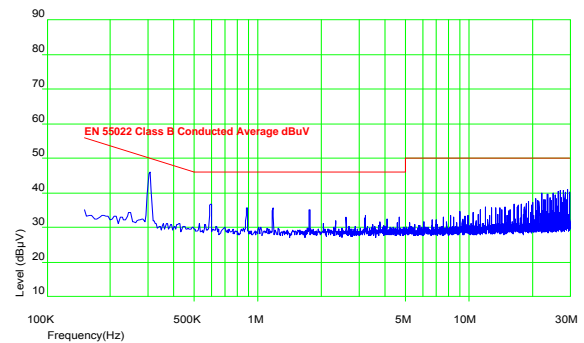

Figure 68. EMC signature using above filter, HW005A0F.

For further information on designing for EMC compliance, please refer to the FLTR100V10 data sheet (FDS01-043EPS).

## Layout Considerations

The HW/HC005 power module series are low profile in order to be used in fine pitch system card architectures. As such, component clearance between the bottom of the power module and the mounting board is limited. Avoid placing copper areas on the outer layer directly underneath the power module. Also avoid placing via interconnects underneath the power module.

For additional layout guide-lines, refer to FLTR100V10 data sheet.

# HW006/010/012 Series Power Modules; dc-dc Converters

36-75Vdc Input; 1.2 Vdc to 5 Vdc Output; 6.6A to 12A

## Mechanical Outline for HW/HC Surface-Mount Module

Dimensions are in millimeters and (inches).

Tolerances: x.x mm ± 0.5 mm (x.xx in. ± 0.02 in.) [unless otherwise indicated]

x.xx mm ± 0.25 mm (x.xxx in ± 0.010 in.)

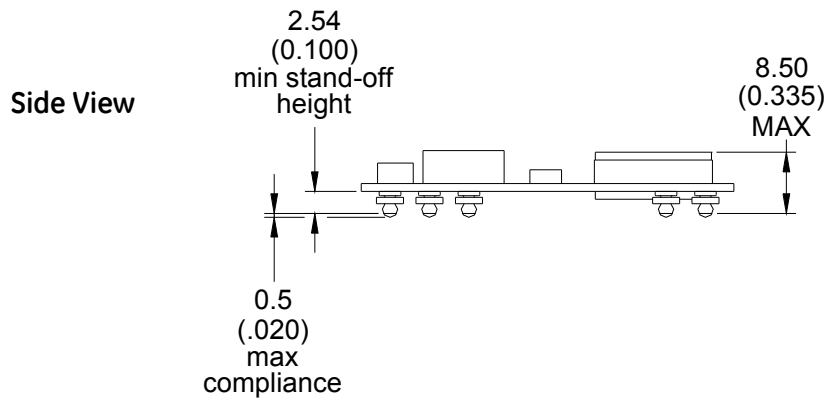
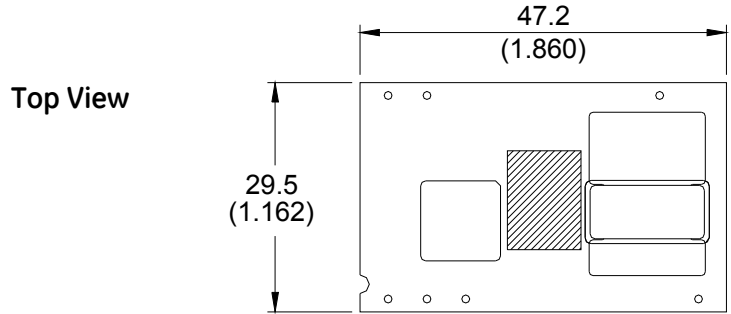

**Bottom View**

Pin	Function
1	Vout +
2	Vout -
3	Standard = No Pin Optional = Vout +
9	Trim
11	On/Off
17	Vin -
18	Vin +

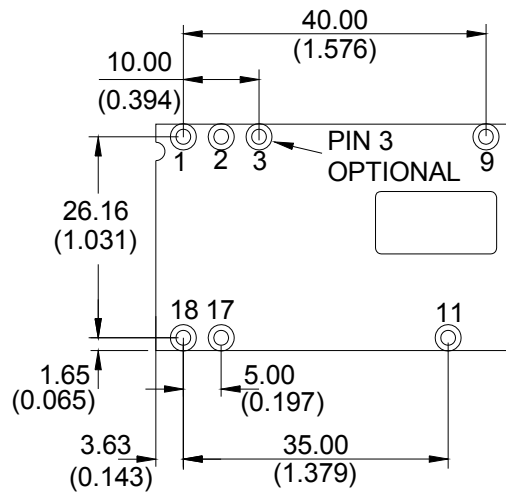

# HW006/010/012 Series Power Modules; dc-dc Converters

36-75Vdc Input; 1.2 Vdc to 5 Vdc Output; 6.6A to 12A

## Mechanical Outline for HW/HC Through Hole Module

Dimensions are in millimeters and (inches).

Tolerances: x.x mm ± 0.5 mm (x.xx in. ± 0.02 in.) [unless otherwise indicated]

x.xx mm ± 0.25 mm (x.xxx in ± 0.010 in.)

Top View

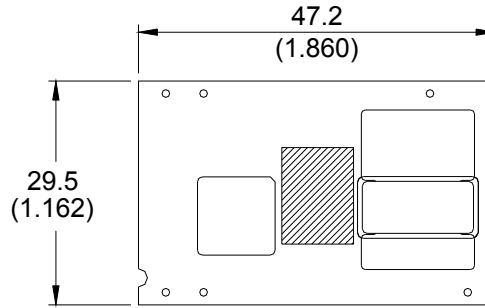

Side View

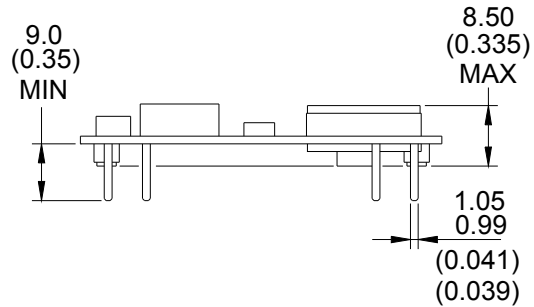

Bottom View

Pin	Function
1	Vout +
2	Vout -
9	Trim
11	On/Off
17	Vin -
18	Vin +

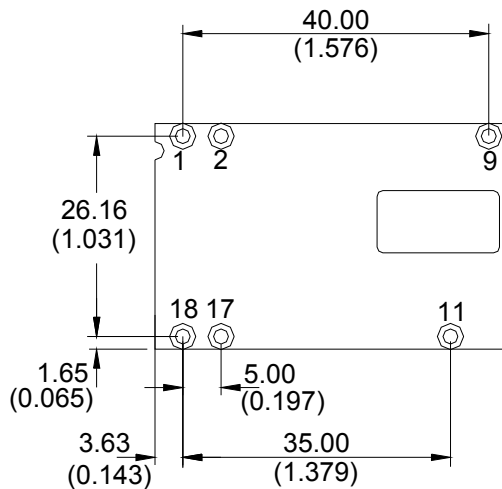

# HW006/010/012 Series Power Modules; dc-dc Converters

36-75Vdc Input; 1.2 Vdc to 5 Vdc Output; 6.6A to 12A

## Recommended Pad Layout for Surface Mount and Through Hole Module

Dimensions are in millimeters and (inches).

Tolerances: x.xx mm ± 0.5 mm (x.xx in. ± 0.02 in.) [unless otherwise indicated]

x.xx mm ± 0.25 mm (x.xxx in ± 0.010 in.)

Pin	Function
1	Vout +
2	Vout -
3	Standard = No Pin Optional = Vout +
9	Trim
11	On/Off
17	Vin -
18	Vin +

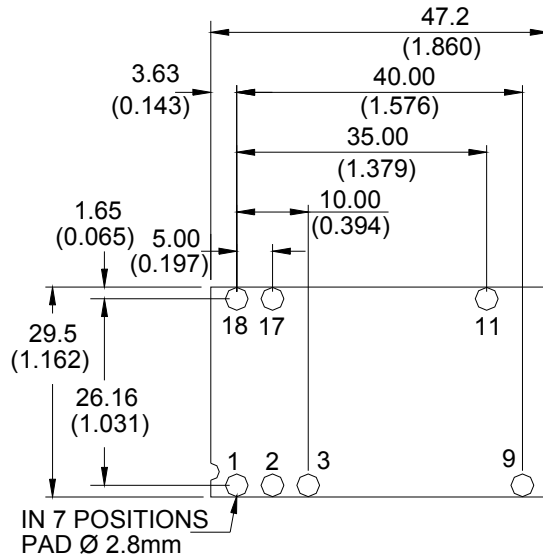

Surface Mount Pad Layout – Component side view

Pin	Function
1	Vout +
2	Vout -
9	Trim
11	On/Off
17	Vin -
18	Vin +

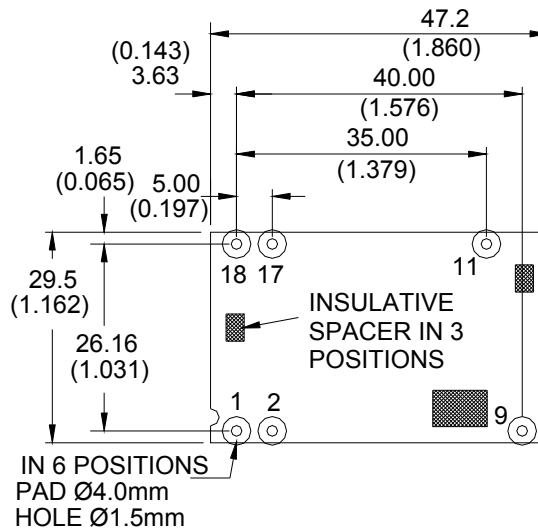

Through-Hole Pad Layout – Component side view

# HW006/010/012 Series Power Modules; dc-dc Converters

36-75Vdc Input; 1.2 Vdc to 5 Vdc Output; 6.6A to 12A

## Packaging Details

The surface mount versions of the HW005 family are also available in tape & reel (suffix -SR) as an option. Detailed of tape dimensions are shown below. Modules are shipped in quantities of 115 per reel.

### Tape Dimensions

Dimensions are in millimeters and (inches).

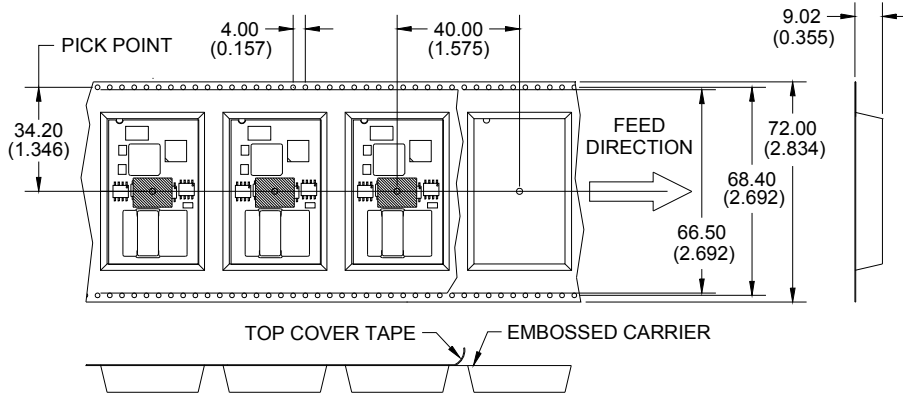

NOTE: CONFORMS TO EAI-481 REV. A STANDARD

### Reel Dimensions

- Outside diameter: 330.2 mm (13.00")
- Inside diameter: 177.8 mm (7.00")
- Tape Width: 72.00 mm (2.834")

# HW006/010/012 Series Power Modules; dc-dc Converters

36-75Vdc Input; 1.2 Vdc to 5 Vdc Output; 6.6A to 12A

## Through-Hole Lead-Free Soldering Information

The RoHS-compliant through-hole products use the SAC (Sn/Ag/Cu) Pb-free solder and RoHS-compliant components. They are designed to be processed through single or dual wave soldering machines. The pins have an RoHS-compliant finish that is compatible with both Pb and Pb-free wave soldering processes. A maximum preheat rate of 3°C/s is suggested. The wave preheat process should be such that the temperature of the power module board is kept below 210°C. For Pb solder, the recommended pot temperature is 260°C, while the Pb-free solder pot is 270°C max. Not all RoHS-compliant through-hole products can be processed with paste-through-hole Pb or Pb-free reflow process. If additional information is needed, please consult with your GE representative for more details.

## Surface Mount Information

### Packaging Details

The surface mount versions of the HW005 family (suffix - S) are supplied as standard in the plastic tray shown in Figure 69. The tray has external dimensions of 135.1mm (W) x 321.8mm (L) x 12.4mm (H) or 5.319in (W) x 12.669in (L) x 0.489in (H).

Surface mount versions of the HW005 family are also available as an option packaged in Tape and Reel. For further information on this please contact your local GE Technical Sales Representative.

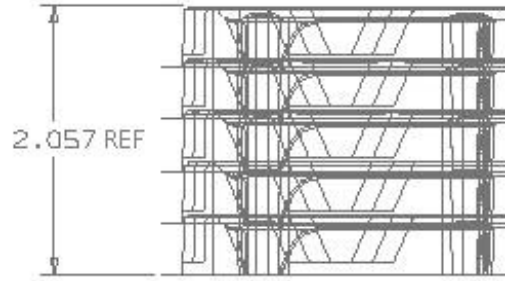
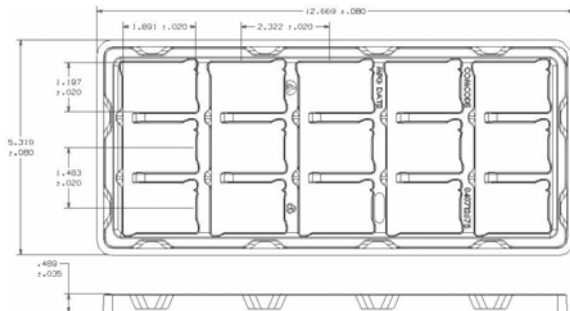

Figure 69. Surface Mount Packaging Tray

### Tray Specification

Material	Antistatic coated PVC
Max surface resistivity	10 <sup>12</sup> Ω/sq
Color	Clear
Capacity	15 power modules
Min order quantity	60 pcs (1 box of 4 full trays)

Each tray contains a total of 15 power modules. The trays are self-stacking and each shipping box will contain 4 full trays plus one empty hold down tray giving a total number of 60 power modules.

### Pick and Place

The HW005-S series of DC-to-DC power converters use an open-frame construction and are designed for surface mount assembly within a fully automated manufacturing process.

The HW005-S series modules are fitted with a Kapton label designed to provide a large flat surface for pick and placing. The label is located covering the Centre of Gravity of the power module. The label meets all the requirements for surface-mount processing, as well as meeting UL safety agency standards. The label will withstand reflow temperatures up to 300°C. The label also carries product information such as product code, date and location of manufacture.

# HW006/010/012 Series Power Modules; dc-dc Converters

36-75Vdc Input; 1.2 Vdc to 5 Vdc Output; 6.6A to 12A

## Surface Mount Information (continued)

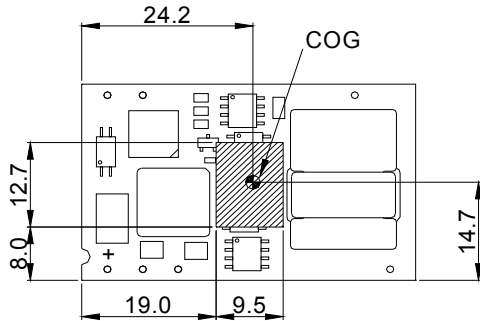

Note: All dimensions in mm.

**Figure 70. Pick and Place Location.**

### Z Plane Height

The 'Z' plane height of the pick and place location is 7.50mm nominal with an RSS tolerance of +/-0.25 mm.

### Nozzle Recommendations

The module weight has been kept to a minimum by using open frame construction. Even so, they have a relatively large mass when compared with conventional SMT components. Variables such as nozzle size, tip style, vacuum pressure and placement speed should be considered to optimize this process.

The minimum recommended nozzle diameter for reliable operation is 6mm. The maximum nozzle outer diameter, which will safely fit within the allowable component spacing, is 9 mm.

Oblong or oval nozzles up to 11 x 9 mm may also be used within the space available.

For further information please contact your local GE Technical Sales Representative.

### Reflow Soldering Information

The HW005 family of power modules is available for either Through-Hole (TH) or Surface Mount (SMT) soldering. These power modules are large mass, low thermal resistance devices and typically heat up slower than other SMT components. It is recommended that the customer review data sheets in order to customize the solder reflow profile for each application board assembly.

The following instructions must be observed when SMT soldering these units. Failure to observe these instructions may result in the failure of or cause damage to the modules, and can adversely affect long-term reliability.

The surface mountable modules in the HW005 family use our newest SMT technology called "Column Pin" (CP) connectors. Fig 71 shows the new CP connector before and after reflow soldering onto the end-board assembly.

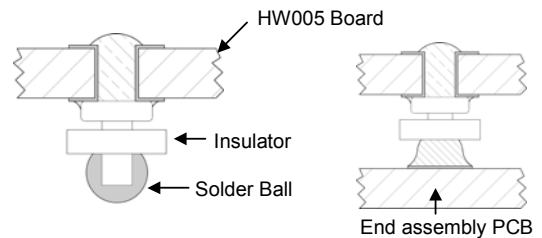

**Figure 71. Column Pin Connector Before and After Reflow Soldering.**

The CP is constructed from a solid copper pin with an integral solder ball attached, which is composed of tin/lead (Sn/Pb) solder. The CP connector design is able to compensate for large amounts of co-planarity and still ensure a reliable SMT solder joint.

Typically, the eutectic solder melts at 183°C, wets the land, and subsequently wicks the device connection. Sufficient time must be allowed to fuse the plating on the connection to ensure a reliable solder joint. There are several types of SMT reflow technologies currently used in the industry. These surface mount power modules can be reliably soldered using natural forced convection, IR (radiant infrared), or a combination of convection/IR. For reliable soldering the solder reflow profile should be established by accurately measuring the modules CP connector temperatures.

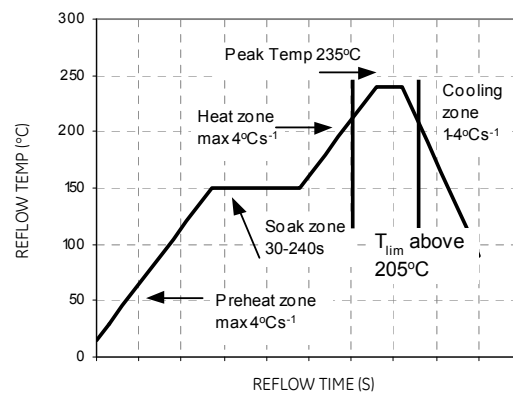

**Figure 72. Recommended Reflow Profile**

# HW006/010/012 Series Power Modules; dc-dc Converters

36-75Vdc Input; 1.2 Vdc to 5 Vdc Output; 6.6A to 12A

## Surface Mount Information (continued)

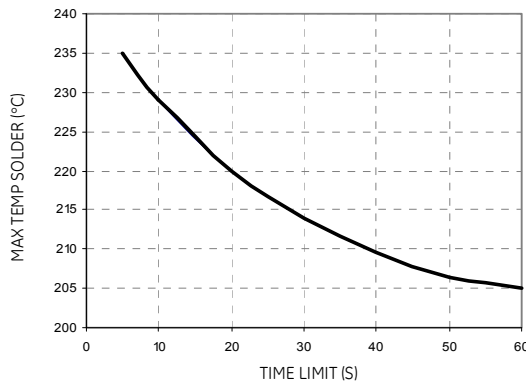

Figure 73. Time Limit Curve Above 205°C Reflow .

### Lead Free Soldering

The -Z version SMT modules of the HW/HC series are lead-free (Pb-free) and RoHS compliant and are compatible in a Pb-free soldering process. Failure to observe the instructions below may result in the failure of or cause damage to the modules and can adversely affect long-term reliability.

### Pb-free Reflow Profile

Power Systems will comply with J-STD-020 Rev. C (Moisture/Reflow Sensitivity Classification for Nonhermetic Solid State Surface Mount Devices) for both Pb-free solder profiles and MSL classification procedures. This standard provides a recommended forced-air-convection reflow profile based on the volume and thickness of the package (table 4-2). The suggested Pb-free solder paste is Sn/Ag/Cu (SAC). The recommended linear reflow profile using Sn/Ag/Cu solder is shown in Figure. 74.

### MSL Rating

The HW/HC series SMT modules have a MSL rating of 2A.

### Storage and Handling

The recommended storage environment and handling procedures for moisture-sensitive surface mount packages is detailed in J-STD-033 Rev. A (Handling, Packing, Shipping and Use of Moisture/Reflow Sensitive Surface Mount Devices). Moisture barrier bags (MBB) with desiccant are required for MSL ratings of 2 or greater. These sealed packages should not be broken until time of use. Once the original package is broken, the floor life of the product at conditions of  $\leq 30^{\circ}\text{C}$  and 60% relative humidity varies according to the MSL rating (see J-STD-033A). The shelf life for dry packed SMT

packages will be a minimum of 12 months from the bag seal date, when stored at the following conditions:  $< 40^{\circ}\text{C}$ ,  $< 90\%$  relative humidity.

### Post Solder Cleaning and Drying Considerations

Post solder cleaning is usually the final circuit-board assembly process prior to electrical board testing. The result of inadequate cleaning and drying can affect both the reliability of a power module and the testability of the finished circuit-board assembly. For guidance on appropriate soldering, cleaning and drying procedures, refer to GE *Board Mounted Power Modules: Soldering and Cleaning* Application Note (AP01-056EPS).

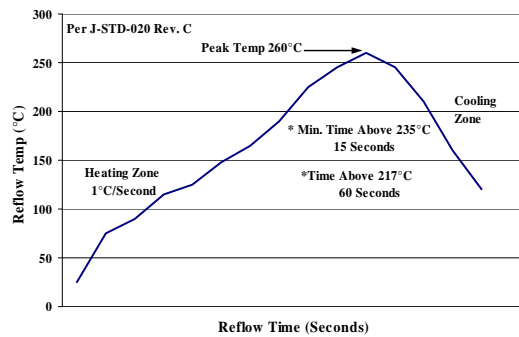

Figure 74. Recommended linear reflow profile using Sn/Ag/Cu solder.

### Solder Ball and Cleanliness Requirements

The open frame (no case or potting) power module will meet the solder ball requirements per J-STD-001B. These requirements state that solder balls must neither be loose nor violate the power module minimum electrical spacing.

The cleanliness designator of the open frame power module is C00 (per J specification).

# HW006/010/012 Series Power Modules; dc-dc Converters

36-75Vdc Input; 1.2 Vdc to 5 Vdc Output; 6.6A to 12A

## Ordering Information

Please contact your GE Sales Representative for pricing, availability and optional features.

**Table 1. Device Codes**

Input Voltage	Output Voltage	Output Current	Efficiency	Connector Type	Device Code	Comcodes
36 – 75 Vdc	3.3V	10A		Through-Hole	HW010A0F1	108967985
36 – 75 Vdc	3.3V	10A		Through-Hole	HW010A0F1Z	CC109107141
36 – 75 Vdc	3.3V	10A		Through-Hole	HW010A0F1-43Z	150035318
36 – 75 Vdc	5.0V	6.6A		Through-Hole	HW006A6A1	108968355
36 – 75 Vdc	5.0V	6.6A		Through-Hole	HW006A6A1Z	CC109107133
36 – 75 Vdc	1.2V	12A		SMT	HW012A0Y1-S	108968405
36 – 75 Vdc	2.5V	10A		SMT	HW010A0G1-S	108968421
36 – 75 Vdc	2.5V	5A		SMT	HW010A0G1-SZ	CC109113602
36 – 75 Vdc	3.3V	10A		SMT	HW010A0F1-S	108965625
36 – 75 Vdc	3.3V	10A		SMT	HW010A0F1-SZ	108995214
36 – 75 Vdc	3.3V	10A		SMT	HW010A0F1-SR	108997656
36 – 75 Vdc	3.3V	10A		SMT (tape & reel)	HW010A0F1-SRZ	CC109107158
36 – 75 Vdc	3.3V	10A		SMT (tape & reel)	HW010A0F1-55SR	CC109124822
36 – 75 Vdc	5.0V	6.6A		SMT	HW006A6A-S	CC109142155
36 – 75 Vdc	5.0V	6.6A		SMT	HW006A6A1-S	108968363
36 – 75 Vdc	5.0V	6.6A		SMT	HW006A6A1-SZ	109100352

**Table 2. Device Options**

Option	Suffix
Negative remote on/off logic	1
Customer specific	-43
Customer specific	-55
Tape & Reel	-R
Surface mount connections	-S
RoHS Compliant	-Z

\* Please contact GE for availability of these options, samples, minimum order quantity and lead times

## Contact Us

For more information, call us at

USA/Canada:

**+1 877 546 3243**, or +1 972 244 9288

Asia-Pacific:

**+86.021.54279977\*808**

Europe, Middle-East and Africa:

**+49.89.878067-280**





[www.gecriticalpower.com](http://www.gecriticalpower.com)

GE Critical Power reserves the right to make changes to the product(s) or information contained herein without notice, and no liability is assumed as a result of their use or application. No rights under any patent accompany the sale of any such product(s) or information.

## Looking for pricing, stock, or lifecycle information?

Click below to explore more details on WIN SOURCE:

-  [View HW010A0F1-S on WIN SOURCE](#)
-  [GE Critical Power Information](#)

## Optimize Your Supply Chain with WIN SOURCE Solutions

-  Global Sourcing Solution
-  Obsolete Management
-  Cost Control Management
-  Shortage Management
-  Alternative Solution
-  Excess Inventory Management