



**THE DATASHEET OF
HZ0805E601R-00**





High Impedance Ferrite Chip Beads

Steward's surface mount ferrite chips provide compact, cost effective EMI filtering for densely packed PCB designs. The small footprint enables placement very close to troublesome high frequency devices. Our proprietary SMT construction yields rugged components with superior impedance vs. frequency characteristics.

Features:

- Small footprint
- Excellent retention under Bias
- Rugged, monolithic construction
- Superior impedance vs. frequency characteristics
- Economical
- Broad range of sizes
- Broad range of impedance values and current ratings

Application:

- Filtering of power input pins and devices using high speed clocks
- Filtering of low frequency input/output signals of shielded enclosures
- High frequency filtering of medium speed clocks and video signals
- Preventing oscillations in high frequency amplifiers
- Data bus filtration
- Discrete component filtration in power supplies

Test Specifications:

- Maximum current ratings are determined by testing to a maximum temperature rise of 40° C with continuous operating current
- Board level components are rated up to a maximum of 75 volts

Tested with: • HP4396A (100KHz - 1.8 GHz) or HP8753 (to 6 GHz) Network/Spectrum Analyzer • HP43961A Impedance Test Kit • HP16192A Test Fixture or Inter-Continental Microwave custom fixtures • HP16200A DC Bias Adapter • Philips PM2811 DC Power Supply • Ambient Temperature 23.5°C ± 2° • Bandwidth 3 kHz • Sweep Time 423 ms • Impedance is rated at ± 25% @ 100MHz

PART NUMBERING SYSTEM					
<u>HZ</u>	<u>0402</u>	<u>A</u>	<u>601</u>	<u>R</u>	<u>- 00</u>
PRODUCT SERIES CODE	PART SIZE CODE	RATED CURRENT CODE	IMPEDANCE VALUE CODE	PACKAGING CODE	ADDITIONAL PART DESCRIPTION

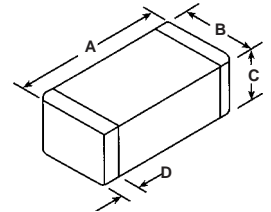

Ambient Operating Temperature Range: -55° C to +125° C

PART NUMBER	A mm (inches)	B mm (inches)	C mm (inches)	D mm (inches)	IMPEDANCE (Z) TYPICAL OHMS @			DCR MAX OHMS	RATED I MAX (continuous) mA
					100MHz	500MHz	1GHz		
HZ0402A601R-00	1.01 ± 0.18 (0.040 ± 0.007)	0.50 ± 0.20 (0.020 ± 0.008)	0.50 ± 0.20 (0.020 ± 0.008)	0.30 MAX (0.012 MAX)	600	644	399	1.000	100
HZ0603C601R-00	1.60 ± 0.15 (0.063 ± 0.006)	0.80 ± 0.15 (0.031 ± 0.006)	0.80 ± 0.15 (0.031 ± 0.006)	0.36 ± 0.15 (0.014 ± 0.006)	600	338	171	0.450	300
HZ0603B751R-00	1.60 ± 0.15 (0.063 ± 0.006)	0.80 ± 0.15 (0.031 ± 0.006)	0.80 ± 0.15 (0.031 ± 0.006)	0.36 ± 0.15 (0.014 ± 0.006)	750	331	168	0.600	200
HZ0603B102R-00	1.60 ± 0.15 (0.063 ± 0.006)	0.80 ± 0.15 (0.031 ± 0.006)	0.80 ± 0.15 (0.031 ± 0.006)	0.36 ± 0.15 (0.014 ± 0.006)	1,000	376	187	0.600	200
HZ0805E401R-00	2.00 ± 0.20 (0.079 ± 0.008)	1.25 ± 0.20 (0.049 ± 0.008)	0.90 ± 0.20 (0.035 ± 0.008)	0.51 ± 0.25 (0.020 ± 0.010)	400	390	180	0.300	500
HZ0805E601R-00	2.00 ± 0.20 (0.079 ± 0.008)	1.25 ± 0.20 (0.049 ± 0.008)	0.90 ± 0.20 (0.035 ± 0.008)	0.51 ± 0.25 (0.020 ± 0.010)	600	304	151	0.300	500
HZ0805D102R-00	2.00 ± 0.20 (0.079 ± 0.008)	1.25 ± 0.20 (0.049 ± 0.008)	0.90 ± 0.20 (0.035 ± 0.008)	0.51 ± 0.25 (0.020 ± 0.010)	1,000	328	168	0.350	400
HZ0805D152R-00	2.00 ± 0.20 (0.079 ± 0.008)	1.25 ± 0.20 (0.049 ± 0.008)	0.90 ± 0.20 (0.035 ± 0.008)	0.51 ± 0.25 (0.020 ± 0.010)	1,500	265	140	0.400	400
HZ0805C202R-00	2.00 ± 0.20 (0.079 ± 0.008)	1.25 ± 0.20 (0.049 ± 0.008)	0.90 ± 0.20 (0.035 ± 0.008)	0.51 ± 0.25 (0.020 ± 0.010)	2,000	345	175	0.500	300
HZ1206E601R-00	3.20 ± 0.20 (0.126 ± 0.008)	1.60 ± 0.20 (0.063 ± 0.008)	1.10 ± 0.20 (0.043 ± 0.008)	0.51 ± 0.25 (0.020 ± 0.010)	600	202	103	0.300	500
HZ1206E801R-00	3.20 ± 0.20 (0.126 ± 0.008)	1.60 ± 0.20 (0.063 ± 0.008)	1.10 ± 0.20 (0.043 ± 0.008)	0.51 ± 0.25 (0.020 ± 0.010)	800	137	95	0.300	500
HZ1206D102R-00	3.20 ± 0.20 (0.126 ± 0.008)	1.60 ± 0.20 (0.063 ± 0.008)	1.10 ± 0.20 (0.043 ± 0.008)	0.51 ± 0.25 (0.020 ± 0.010)	1,000	185	100	0.400	400

PART NUMBER	A mm (inches)	B mm (inches)	C mm (inches)	D mm (inches)	IMPEDANCE (Z) TYPICAL OHMS @			DCR MAX OHMS	RATED I MAX (continuous) mA
					100MHz	500MHz	1GHz		
HZ1206E152R-00	3.20 ± 0.20 (0.126 ± 0.008)	1.60 ± 0.20 (0.063 ± 0.008)	1.10 ± 0.20 (0.043 ± 0.008)	0.51 ± 0.25 (0.020 ± 0.010)	1,500	115	99	0.300	500
HZ1206C202R-00	3.20 ± 0.20 (0.126 ± 0.008)	1.60 ± 0.20 (0.063 ± 0.008)	1.10 ± 0.20 (0.043 ± 0.008)	0.51 ± 0.25 (0.020 ± 0.010)	2,000	427	231	0.500	300

HZ0402A601R-00

Z, R, X_L vs. Frequency
Impedance, Resistance, Inductive Reactance

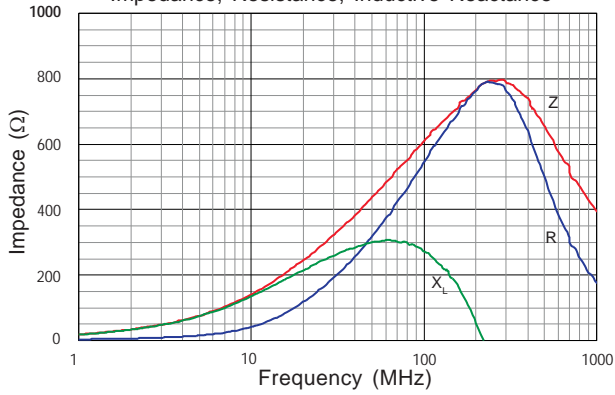

HZ0402A601R-00

Z vs. Frequency
Impedance Under DC Bias

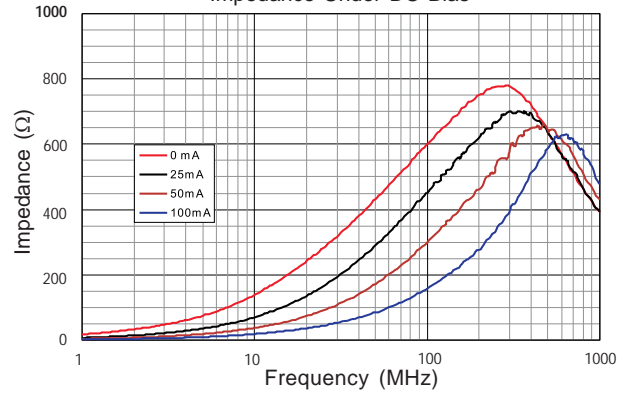

HZ0603C601R-00

Z, R, X_L vs. Frequency
Impedance, Resistance, Inductive Reactance

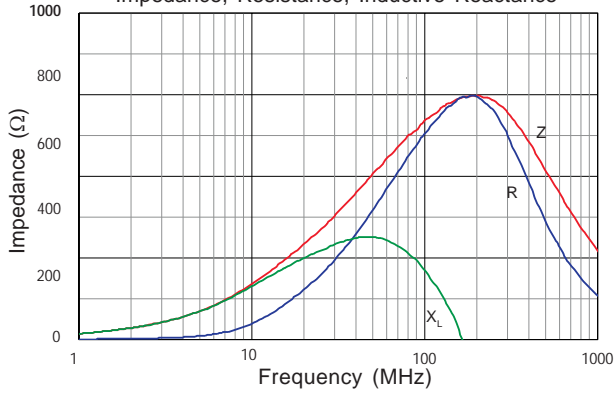

HZ0603C601R-00

Z vs. Frequency
Impedance Under DC Bias

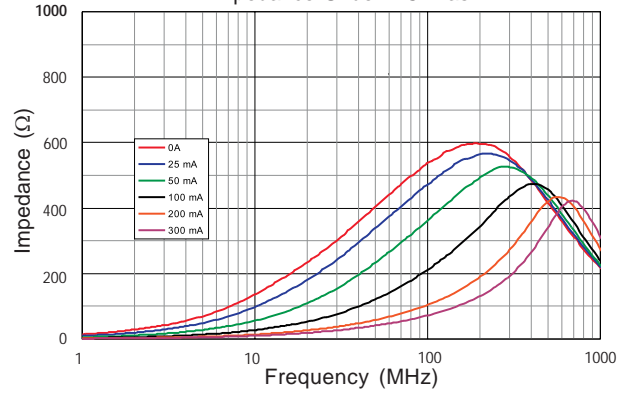

HZ0603B751R-00

Z, R, X_L vs. Frequency
Impedance, Resistance, Inductive Reactance

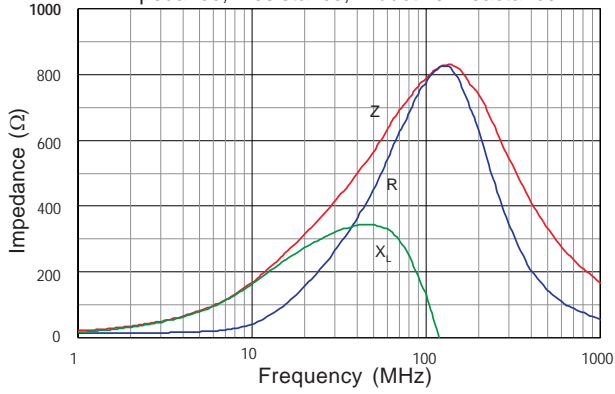

HZ0603B751R-00

Z vs. Frequency
Impedance Under DC Bias

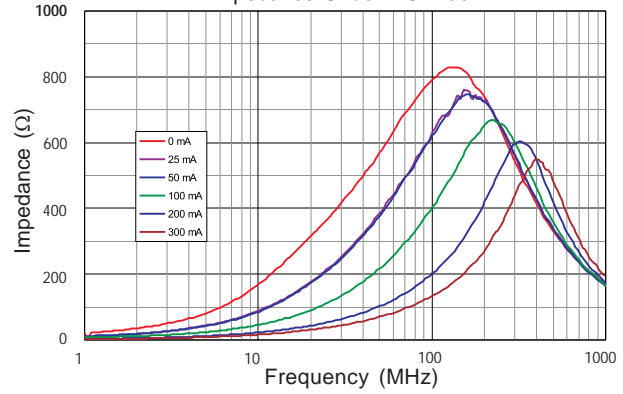

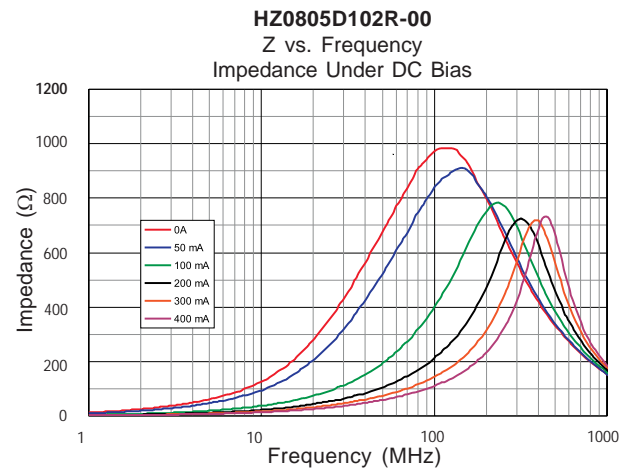
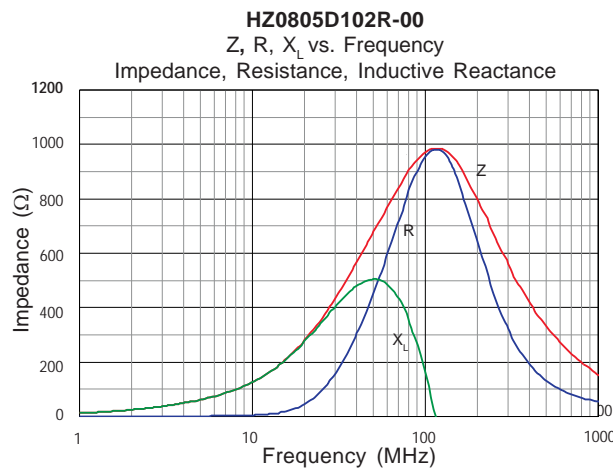
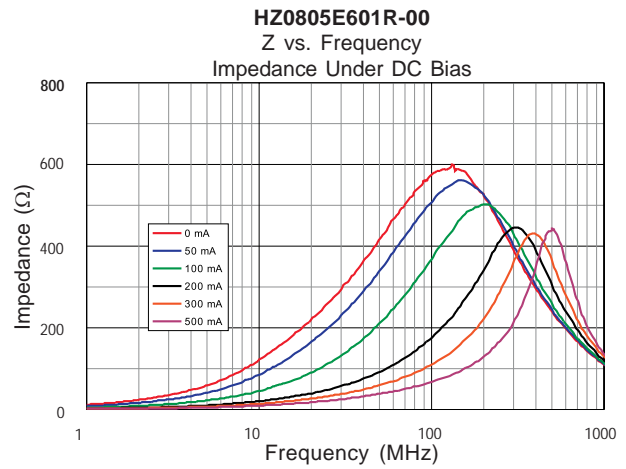
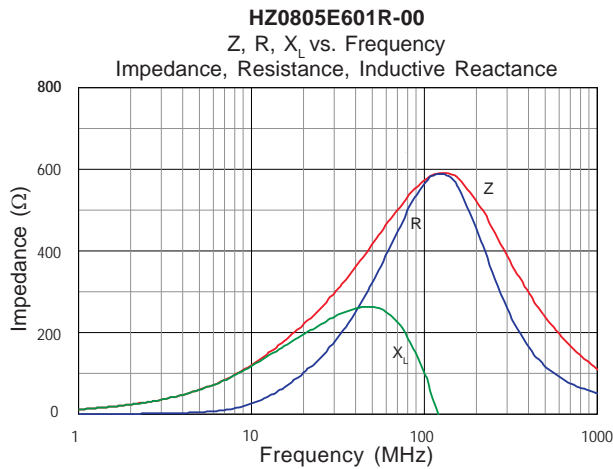
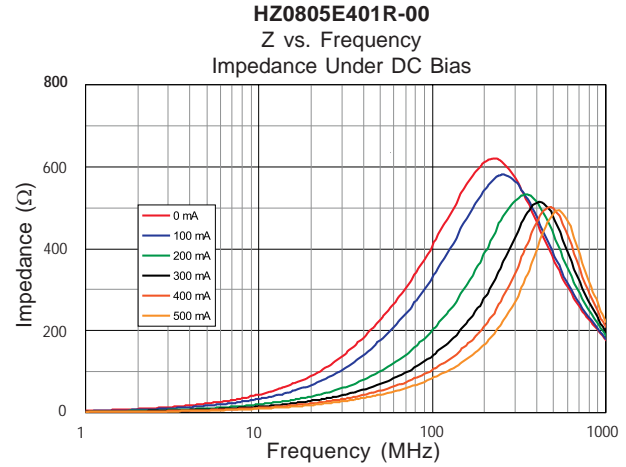
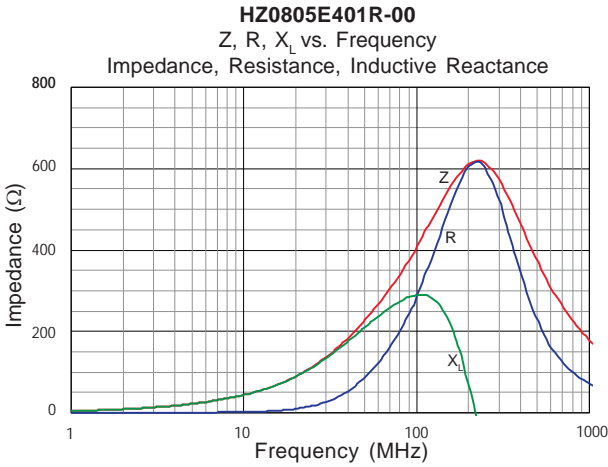
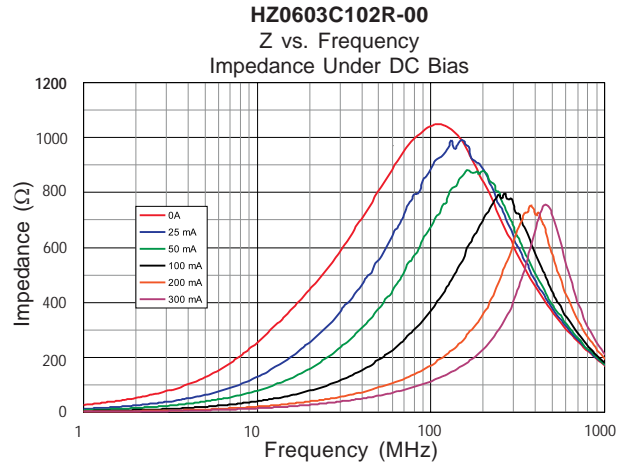
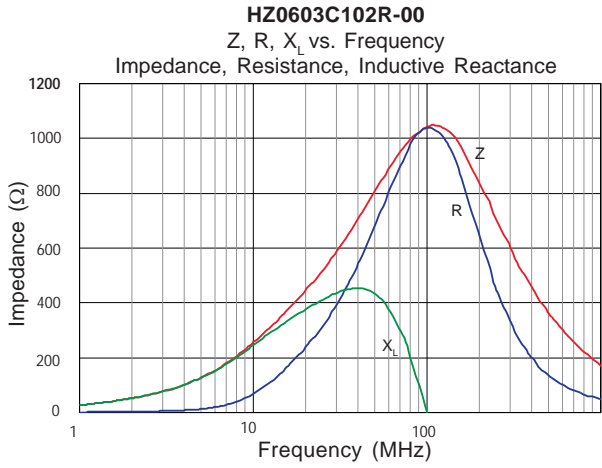

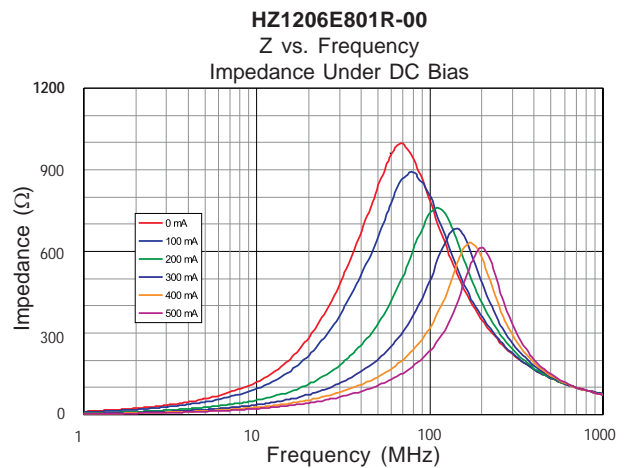
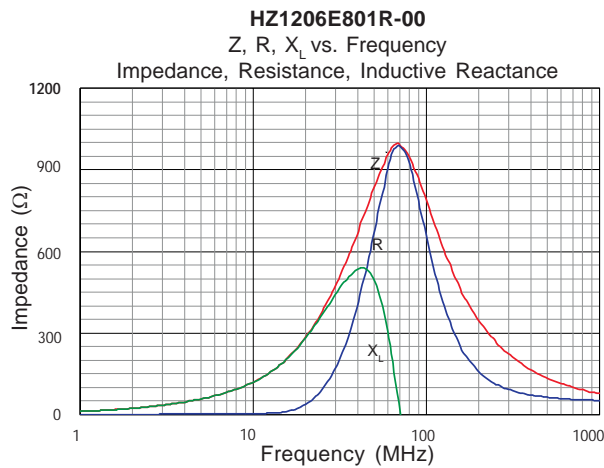
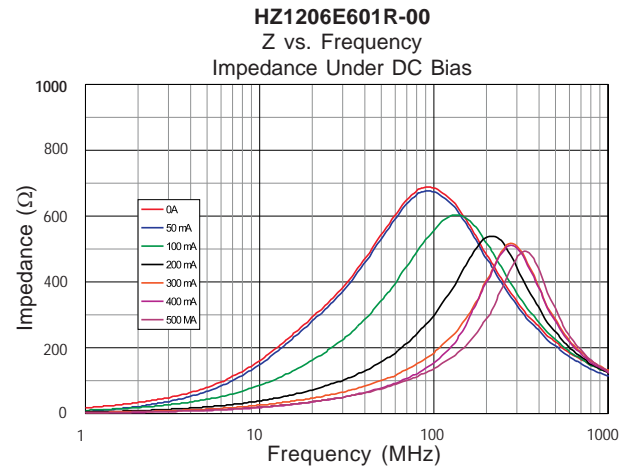
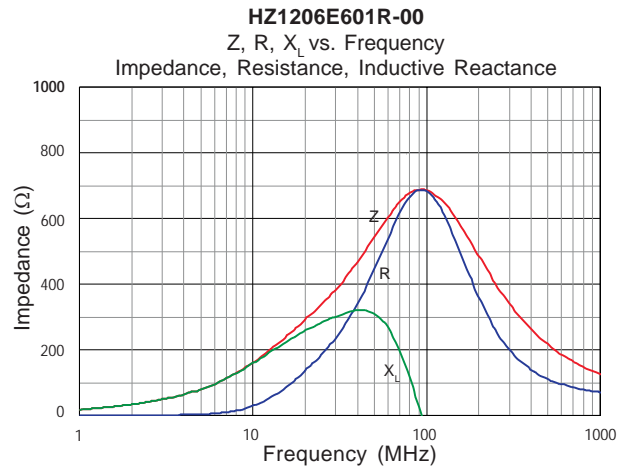
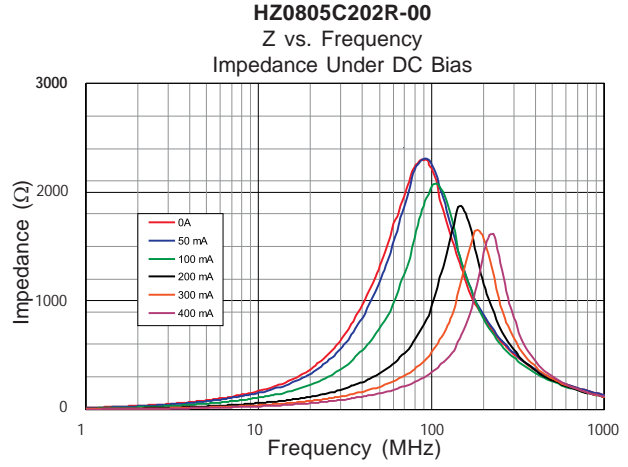
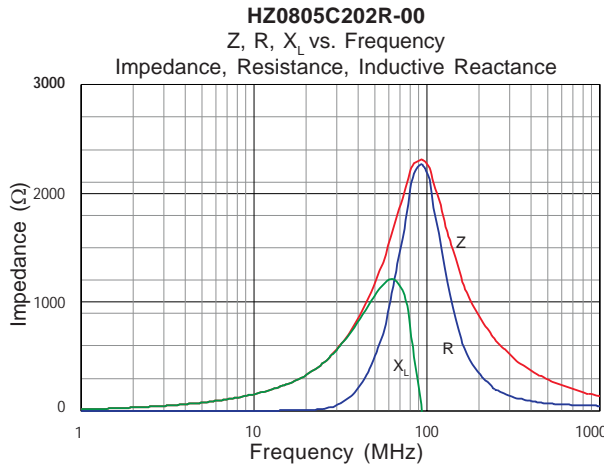
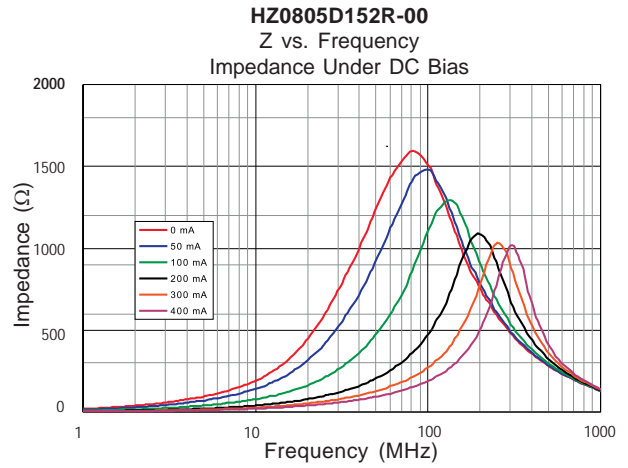
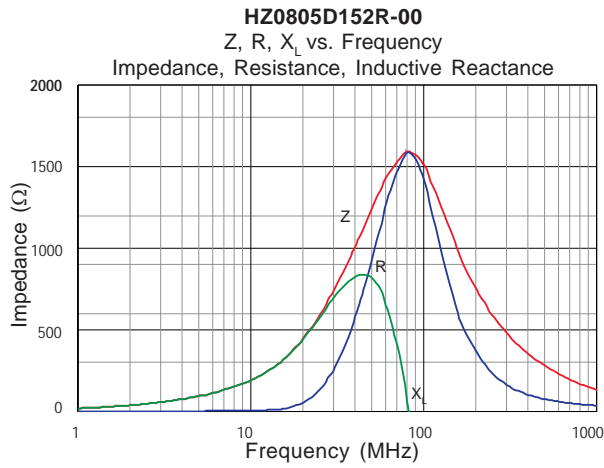

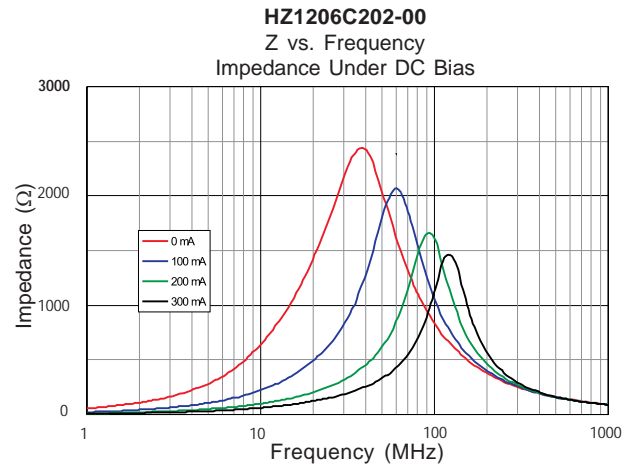
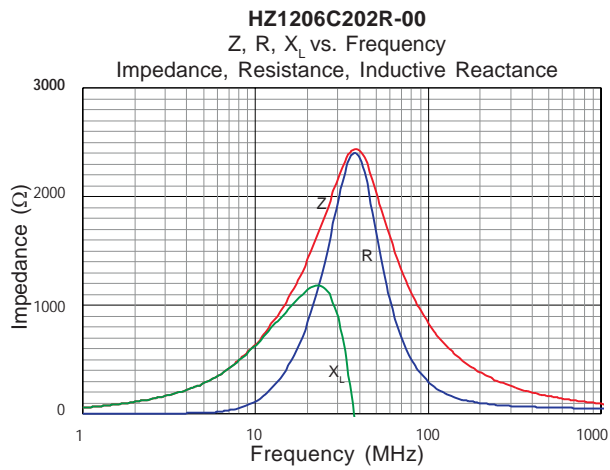
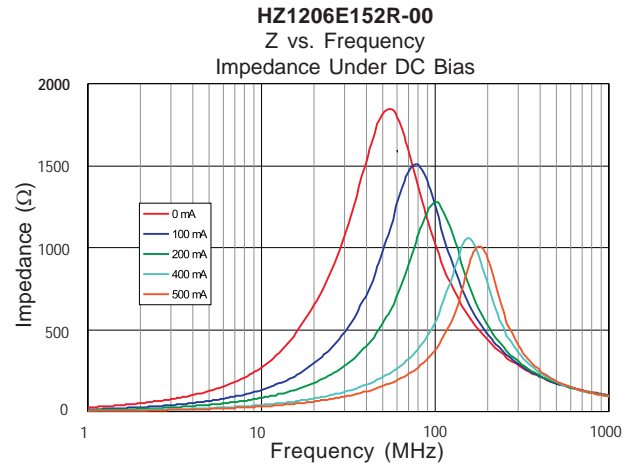
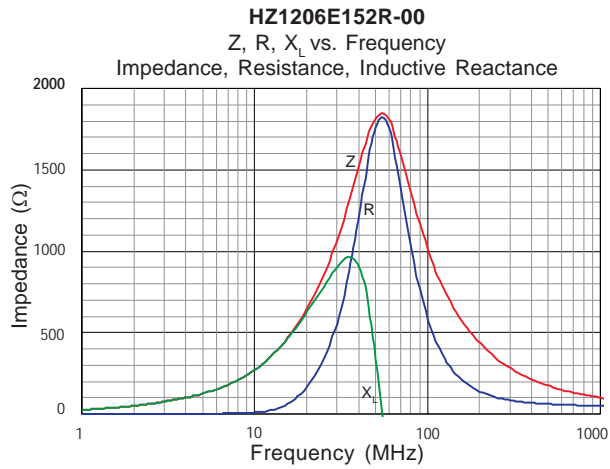
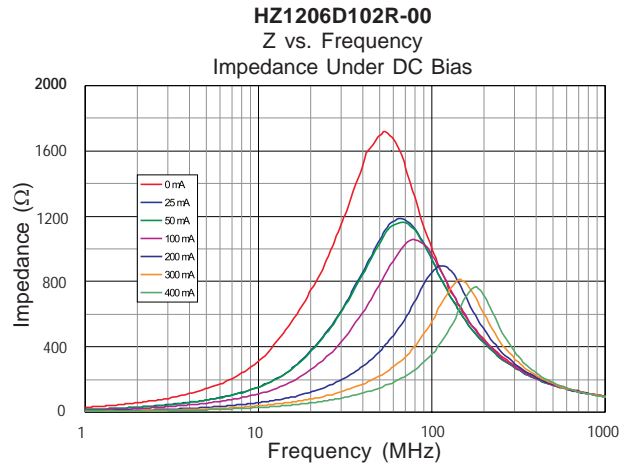
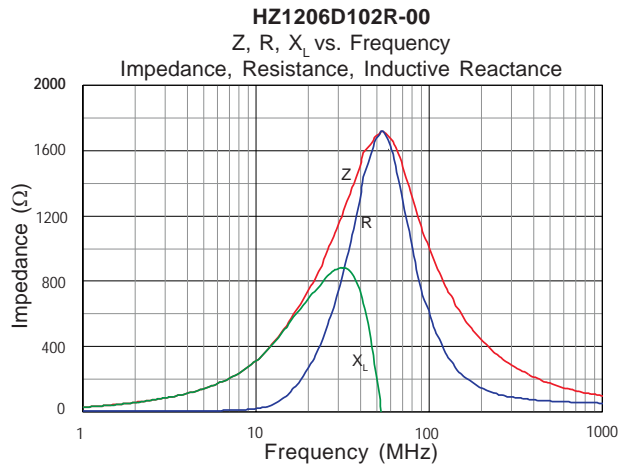

Tape & Reel Specifications

HZ, IC & IH Tape Specifications											Reel Size				
P/N	A	A ₀	B	B ₀	C	D	D ₀	E	F	F ₀	F ₁	G	H	T	Reel Size
HZ0402	1.20 (0.047)	1.60 ± 0.10 (0.063 ± 0.004)	1.80 (0.071)	1.15 ± 0.10 (0.045 ± 0.004)	0.85 ± 0.10 (0.033 ± 0.004)	3.50 ± 0.05 (0.138 ± 0.002)	1.75 ± 0.10 (0.069 ± 0.004)	4.00 ± 0.10 (0.157 ± 0.004)	1.00 ± 0.25 (0.039 ± 0.010)	2.00 ± 0.05 (0.079 ± 0.002)	1.50 ± 0.10 (0.059 ± 0.004)	8.00 ± 0.30 / - 0.10 (0.315 ± 0.012 / - 0.004)	4.00 ± 0.10 (0.157 ± 0.004)	0.25 ± 0.013 (0.010 ± 0.0005)	7"
HZ0603	2.21 (0.087)	1.88 ± 0.10 (0.074 ± 0.004)	3.76 (0.148)	3.56 ± 0.10 (0.140 ± 0.004)	1.91 ± 0.10 (0.075 ± 0.004)	3.50 ± 0.05 (0.138 ± 0.002)	1.75 ± 0.10 (0.069 ± 0.004)	4.00 ± 0.10 (0.157 ± 0.004)	1.00 ± 0.25 (0.039 ± 0.010)	2.00 ± 0.05 (0.079 ± 0.002)	1.50 ± 0.10 (0.059 ± 0.004)	8.00 ± 0.30 / - 0.10 (0.315 ± 0.012 / - 0.004)	4.00 ± 0.10 (0.157 ± 0.004)	0.25 ± 0.013 (0.010 ± 0.0005)	7"
HZ0805	1.85 (0.073)	1.55 ± 0.10 (0.061 ± 0.004)	2.49 (0.098)	2.31 ± 0.10 (0.091 ± 0.004)	1.30 ± 0.10 (0.051 ± 0.004)	3.50 ± 0.05 (0.138 ± 0.002)	1.75 ± 0.10 (0.069 ± 0.004)	4.00 ± 0.10 (0.157 ± 0.004)	1.00 ± 0.25 (0.039 ± 0.010)	2.00 ± 0.05 (0.079 ± 0.002)	1.50 ± 0.10 (0.059 ± 0.004)	8.00 ± 0.30 / - 0.10 (0.315 ± 0.012 / - 0.004)	4.00 ± 0.10 (0.157 ± 0.004)	0.25 ± 0.013 (0.010 ± 0.0005)	7"
HZ1206	2.21 (0.087)	1.88 ± 0.10 (0.074 ± 0.004)	3.76 (0.148)	3.56 ± 0.10 (0.140 ± 0.004)	1.91 ± 0.10 (0.075 ± 0.004)	3.50 ± 0.05 (0.138 ± 0.002)	1.75 ± 0.10 (0.069 ± 0.004)	4.00 ± 0.10 (0.157 ± 0.004)	1.00 ± 0.25 (0.039 ± 0.010)	2.00 ± 0.05 (0.079 ± 0.002)	1.50 ± 0.10 (0.059 ± 0.004)	8.00 ± 0.30 / - 0.10 (0.315 ± 0.012 / - 0.004)	4.00 ± 0.10 (0.157 ± 0.004)	0.25 ± 0.013 (0.010 ± 0.0005)	7"
IC0603	2.21 (0.087)	1.88 ± 0.10 (0.074 ± 0.004)	3.76 (0.148)	3.56 ± 0.10 (0.140 ± 0.004)	1.91 ± 0.10 (0.075 ± 0.004)	3.50 ± 0.05 (0.138 ± 0.002)	1.75 ± 0.10 (0.069 ± 0.004)	4.00 ± 0.10 (0.157 ± 0.004)	1.00 ± 0.25 (0.039 ± 0.010)	2.00 ± 0.05 (0.079 ± 0.002)	1.50 ± 0.10 (0.059 ± 0.004)	8.00 ± 0.30 / - 0.10 (0.315 ± 0.012 / - 0.004)	4.00 ± 0.10 (0.157 ± 0.004)	0.25 ± 0.013 (0.010 ± 0.0005)	7"
IC0805	1.85 (0.073)	1.55 ± 0.10 (0.061 ± 0.004)	2.49 (0.098)	2.31 ± 0.10 (0.091 ± 0.004)	1.30 ± 0.10 (0.051 ± 0.004)	3.50 ± 0.05 (0.138 ± 0.002)	1.75 ± 0.10 (0.069 ± 0.004)	4.00 ± 0.10 (0.157 ± 0.004)	1.00 ± 0.25 (0.039 ± 0.010)	2.00 ± 0.05 (0.079 ± 0.002)	1.50 ± 0.10 (0.059 ± 0.004)	8.00 ± 0.30 / - 0.10 (0.315 ± 0.012 / - 0.004)	4.00 ± 0.10 (0.157 ± 0.004)	0.25 ± 0.013 (0.010 ± 0.0005)	7"
IC1206	2.21 (0.087)	1.88 ± 0.10 (0.074 ± 0.004)	3.76 (0.148)	3.56 ± 0.10 (0.140 ± 0.004)	1.91 ± 0.10 (0.075 ± 0.004)	3.50 ± 0.05 (0.138 ± 0.002)	1.75 ± 0.10 (0.069 ± 0.004)	4.00 ± 0.10 (0.157 ± 0.004)	1.00 ± 0.25 (0.039 ± 0.010)	2.00 ± 0.05 (0.079 ± 0.002)	1.50 ± 0.10 (0.059 ± 0.004)	8.00 ± 0.30 / - 0.10 (0.315 ± 0.012 / - 0.004)	4.00 ± 0.10 (0.157 ± 0.004)	0.25 ± 0.013 (0.010 ± 0.0005)	7"
IH0402	1.20 (0.047)	1.60 ± 0.10 (0.063 ± 0.004)	1.80 (0.071)	1.15 ± 0.10 (0.045 ± 0.004)	0.85 ± 0.10 (0.033 ± 0.004)	3.50 ± 0.05 (0.138 ± 0.002)	1.75 ± 0.10 (0.069 ± 0.004)	4.00 ± 0.10 (0.157 ± 0.004)	1.00 ± 0.25 (0.039 ± 0.010)	2.00 ± 0.05 (0.079 ± 0.002)	1.50 ± 0.10 (0.059 ± 0.004)	8.00 ± 0.30 / - 0.10 (0.315 ± 0.012 / - 0.004)	4.00 ± 0.10 (0.157 ± 0.004)	0.25 ± 0.013 (0.010 ± 0.0005)	7"
IH0603	2.21 (0.087)	1.88 ± 0.10 (0.074 ± 0.004)	3.76 (0.148)	3.56 ± 0.10 (0.140 ± 0.004)	1.91 ± 0.10 (0.075 ± 0.004)	3.50 ± 0.05 (0.138 ± 0.002)	1.75 ± 0.10 (0.069 ± 0.004)	4.00 ± 0.10 (0.157 ± 0.004)	1.00 ± 0.25 (0.039 ± 0.010)	2.00 ± 0.05 (0.079 ± 0.002)	1.50 ± 0.10 (0.059 ± 0.004)	8.00 ± 0.30 / - 0.10 (0.315 ± 0.012 / - 0.004)	4.00 ± 0.10 (0.157 ± 0.004)	0.25 ± 0.013 (0.010 ± 0.0005)	7"
IH0805	1.85 (0.073)	1.55 ± 0.10 (0.061 ± 0.004)	2.49 (0.098)	2.31 ± 0.10 (0.091 ± 0.004)	1.30 ± 0.10 (0.051 ± 0.004)	3.50 ± 0.05 (0.138 ± 0.002)	1.75 ± 0.10 (0.069 ± 0.004)	4.00 ± 0.10 (0.157 ± 0.004)	1.00 ± 0.25 (0.039 ± 0.010)	2.00 ± 0.05 (0.079 ± 0.002)	1.50 ± 0.10 (0.059 ± 0.004)	8.00 ± 0.30 / - 0.10 (0.315 ± 0.012 / - 0.004)	4.00 ± 0.10 (0.157 ± 0.004)	0.25 ± 0.013 (0.010 ± 0.0005)	7"

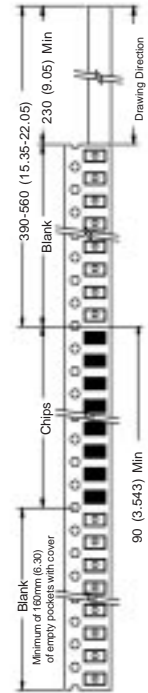
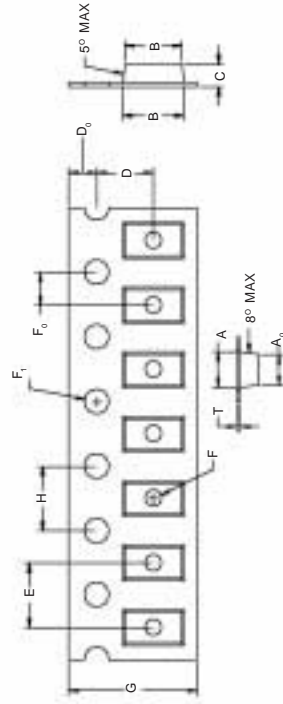

Reel Specifications	
A	330.0 / 178.0 ± 2.0 (13.00 / 7.00 ± 0.078)
B	95.0 ± 1.0 (3.74 ± 0.039)
C	13.0 ± 0.5 (0.51 ± 0.020)
D	21.0 ± 0.8 (0.82 ± 0.031)
E	2.0 ± 0.5 (0.08 ± 0.020)
W	8.0 ± 1.0 (0.32 ± 0.039)
T	1.0 (0.039)

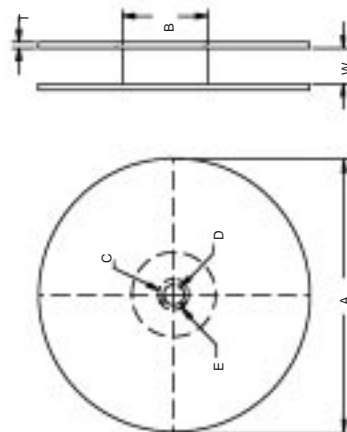

Looking for pricing, stock, or lifecycle information?

Click below to explore more details on WIN SOURCE:

- ⊖ [View HZ0805E601R-00 on WIN SOURCE](#)
- ⊖ [Laird-Signal Integrity Products Information](#)

Optimize Your Supply Chain with WIN SOURCE Solutions

- ✓ Global Sourcing Solution
- ✓ Obsolete Management
- ✓ Cost Control Management
- ✓ Shortage Management
- ✓ Alternative Solution
- ✓ Excess Inventory Management