

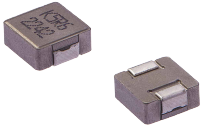

**MDA Series**  
**SMD Low Profile High Current Molded Inductor**  
**Size 7030**



**FEATURES**

- Shielded construction
- Capable of corresponding high frequency .
- Low loss realized with low DCR.
- High performance (Isat) realized by metal dust core.
- Ultra low buzz noise, due to composite construction.
- 100% Lead(Pb)-Free and RoHS compliant.
- AEC-Q200 qualified
- Operating temperature: -55 to +155 °C (including self-temperature rise)
- Quantity: 1000PCS

**APPLICATION**

- Headlamps, tail lamps and interior lighting
- HVAC
- Doors, window lift and seat control
- Audio subsystem
- Digital instrument cluster
- In-Vehicle Infotainment and navigation

**Dimensions: [mm]**

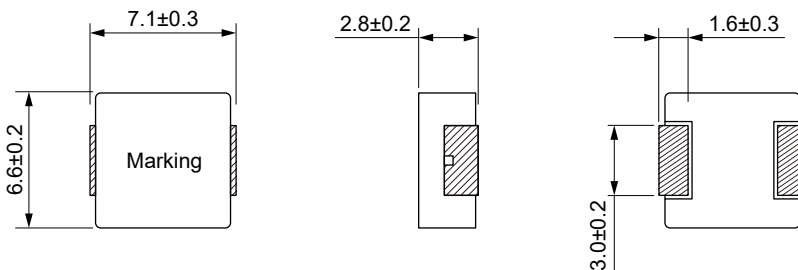

**Land Pattern: [mm]**

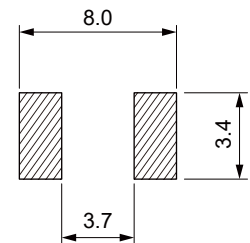

**Electrical Properties:**

Part No	Inductance @ 100KHz/1V (μH)	Tolerance	Temperature Rise Current Typ. (A)	Temperature Rise Current Max. (A)	Saturation Current Typ. (A)	Saturation Current Max. (A)	DC Resistance Typ. (mΩ)	DC Resistance Max. (mΩ)
MDA7030-R15N	0.15	±30%	30.0	25.0	40.0	36.0	1.70	2.10
MDA7030-R22M	0.22	±20%	23.0	21.0	34.0	32.0	2.00	2.50
MDA7030-R33M	0.33	±20%	21.0	20.0	25.0	22.0	2.80	3.40
MDA7030-R36M	0.36	±20%	20.0	18.0	24.0	21.0	3.30	3.90
MDA7030-R47M	0.47	±20%	18.0	16.0	20.0	18.0	3.40	4.00
MDA7030-R56M	0.56	±20%	16.5	15.0	18.0	16.0	3.90	4.50
MDA7030-R68M	0.68	±20%	16.0	14.5	17.0	15.0	4.70	5.30
MDA7030-R82M	0.82	±20%	14.0	13.0	16.0	14.0	5.40	6.00
MDA7030-1R0M	1.00	±20%	12.0	11.0	15.0	13.5	6.70	7.40
MDA7030-1R2M	1.20	±20%	10.0	9.5	14.0	12.5	7.70	9.50

Part No	Inductance @ 100KHz/1V (μH)	Tolerance	Temperature Rise Current Typ. (A)	Temperature Rise Current Max. (A)	Saturation Current Typ. (A)	Saturation Current Max. (A)	DC Resistance Typ. (mΩ)	DC Resistance Max. (mΩ)
MDA7030-1R5M	1.50	±20%	10.0	9.0	14.0	12.0	10.2	12.1
MDA7030-2R2M	2.20	±20%	8.0	7.5	10.0	9.0	13.5	15.0
MDA7030-3R3M	3.30	±20%	6.5	6.0	9.5	8.5	19.0	22.0
MDA7030-4R7M	4.70	±20%	5.5	5.0	6.5	5.5	28.0	33.0
MDA7030-5R6M	5.60	±20%	5.5	5.0	6.0	5.2	39.0	42.0
MDA7030-6R8M	6.80	±20%	4.5	4.2	6.0	5.0	43.0	50.0
MDA7030-8R2M	8.20	±20%	4.5	4.0	6.0	4.7	54.0	60.0
MDA7030-100M	10.0	±20%	4.0	3.5	5.5	4.5	62.0	68.0
MDA7030-150M	15.0	±20%	3.0	2.5	4.5	4.0	110	140
MDA7030-220M	22.0	±20%	2.5	2.0	3.0	2.5	150	190
MDA7030-330M	33.0	±20%	2.1	1.8	2.5	2.0	215	258
MDA7030-470M	47.0	±20%	1.5	1.2	2.0	1.6	318	385

Saturation Current will cause L to drop approximately 30%

Temperature Rise Current: The actual value of DC current when the temperature rise is  $\Delta T=40^{\circ}\text{C}$

### Typical Electrical Characteristics:

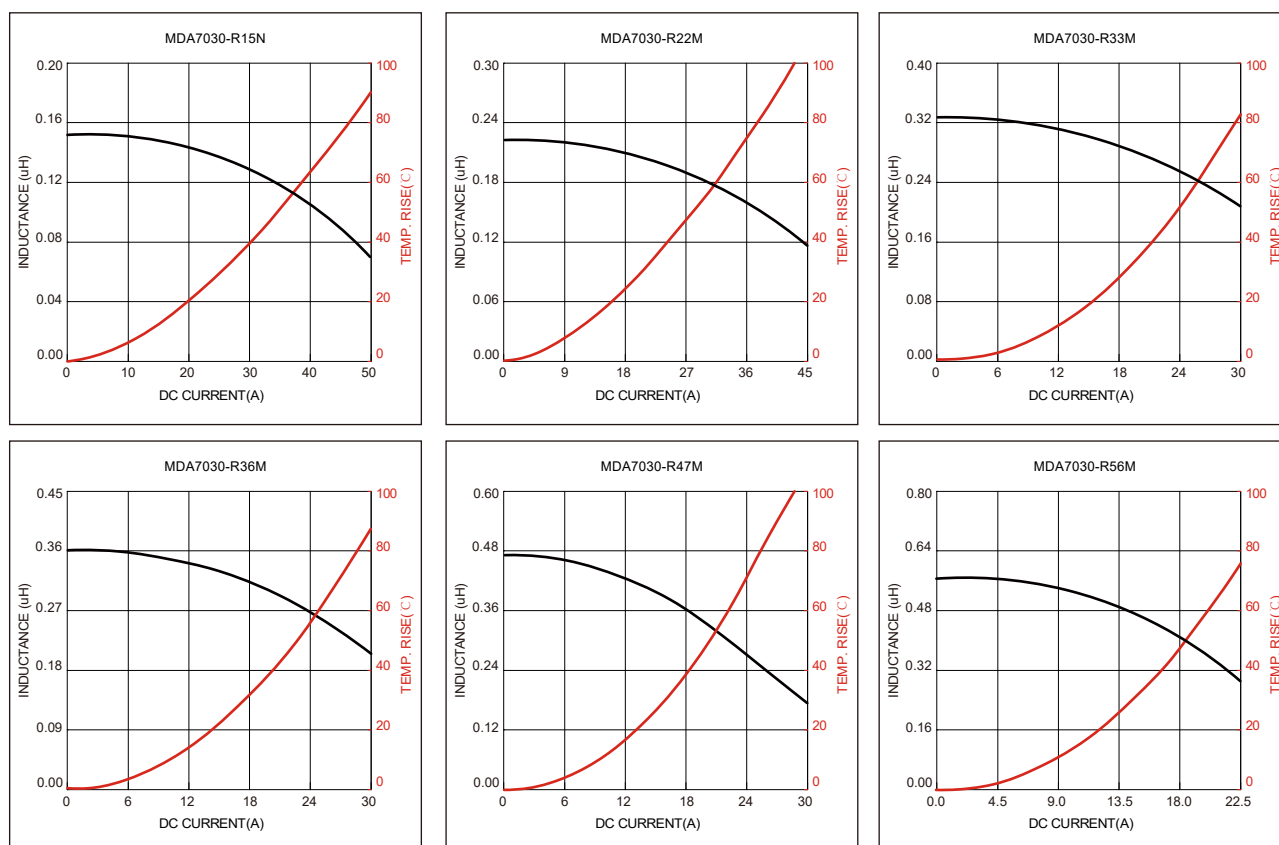

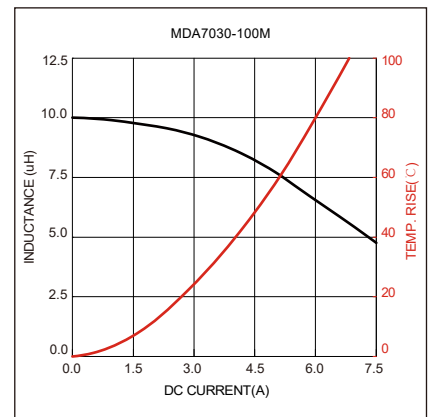
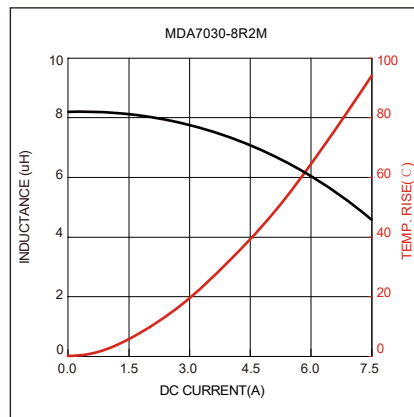
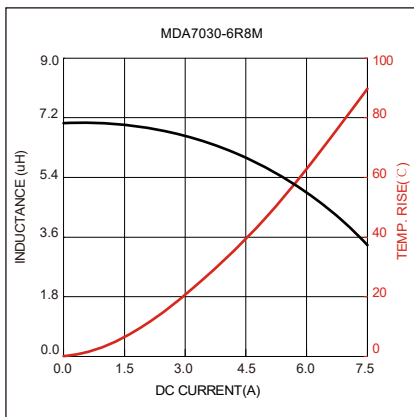
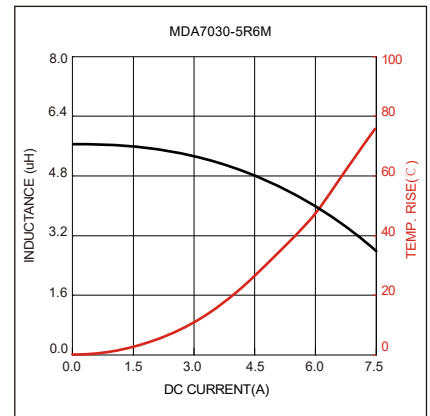
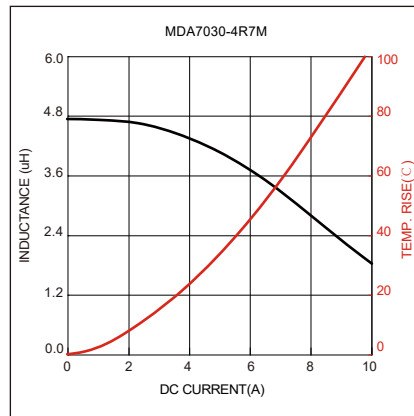
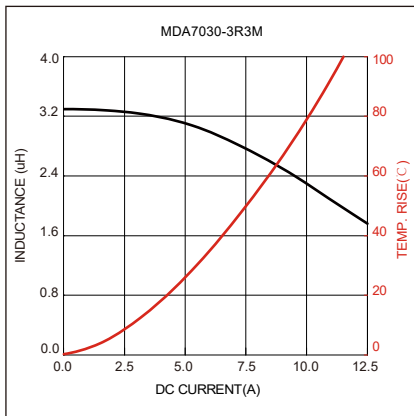
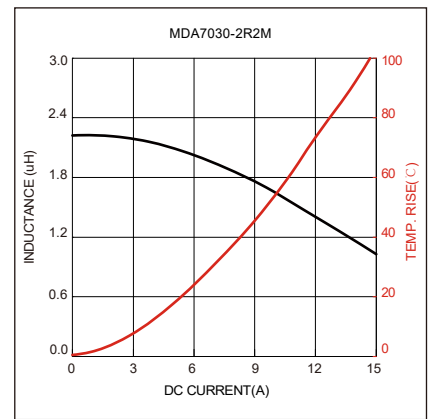
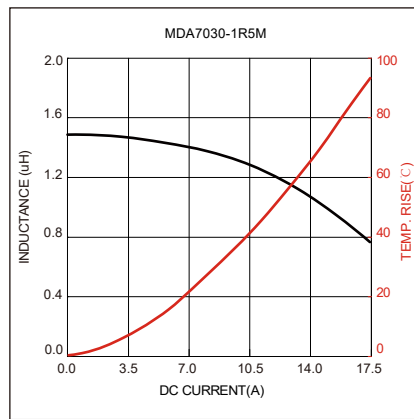
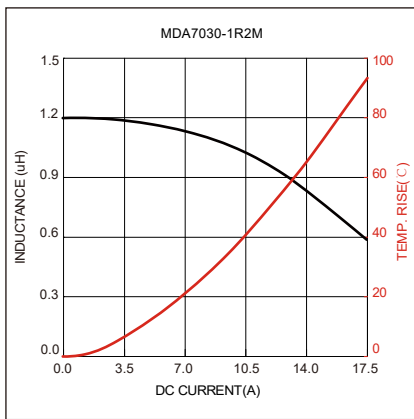
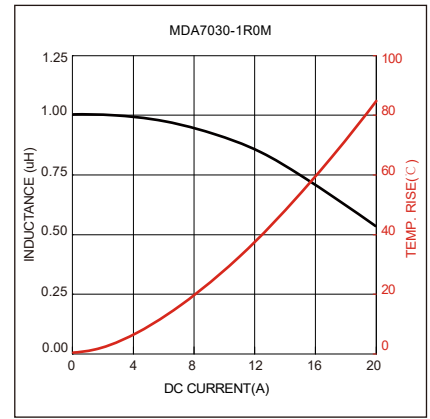
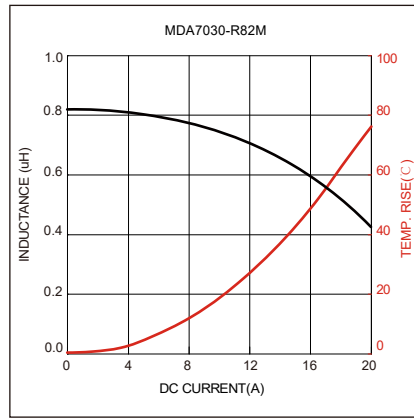
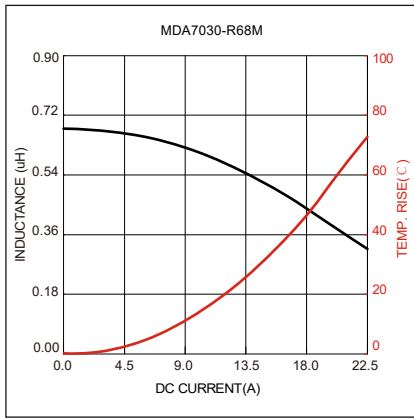

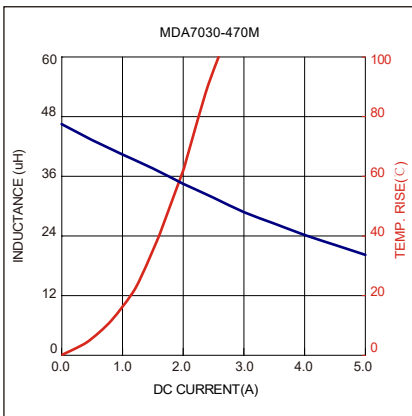
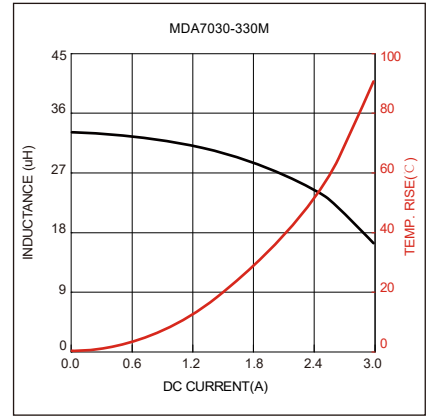
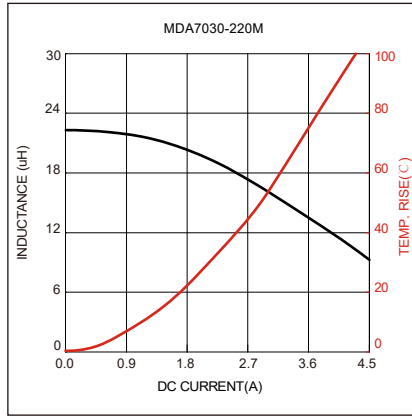
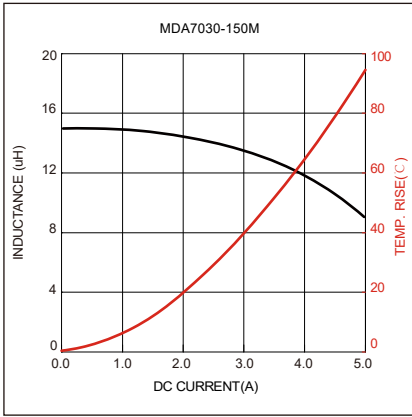

### Soldering Reflow:

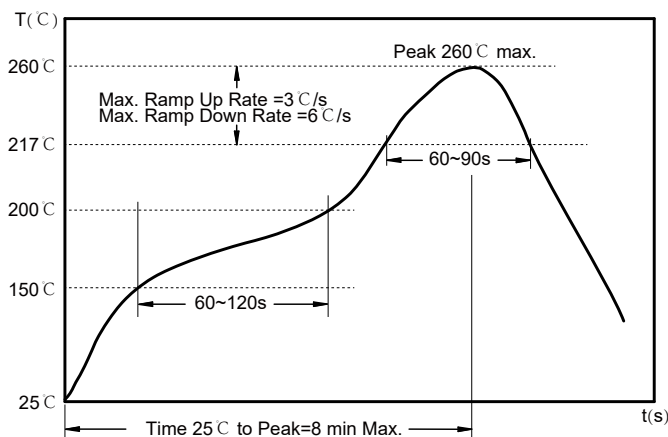

Preheat condition: 150 ~200°C / 60~120 sec.  
 Allowed time above 217°C : 60~90 sec.  
 Max temperature: 260°C .  
 Max time at max temperature: 10 sec.  
 Allowed Reflow time: 2x max.

### Packaging Information:

#### Tape Dimension :

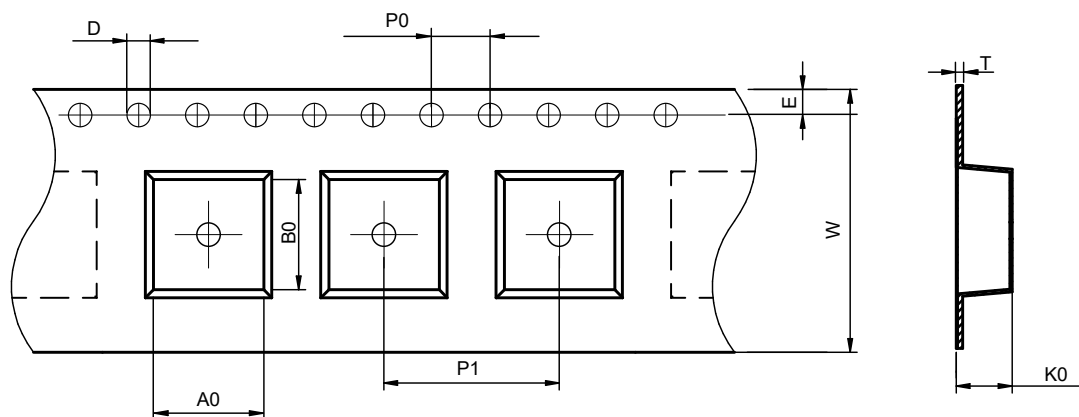

Series	A0 (mm)	B0 (mm)	D (mm)	P0 (mm)	P1 (mm)	W (mm)	K0 (mm)	E (mm)	T (mm)
MDA7030	7.0±0.1	7.7±0.1	1.5±0.1	4.0±0.1	12.0±0.1	16.0±0.3	3.4±0.1	1.75±0.1	0.35±0.05

#### Peel force of top cover tape:

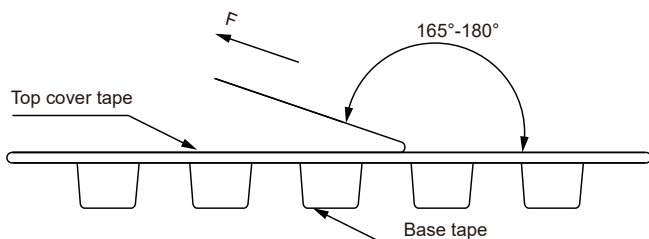

The peel force of top cover tape shall be between 0.1 to 1.3 N

#### Product Marking:

Marking	K+Printing (Inductance+period)
---------	--------------------------------

Reel Dimension: [mm]

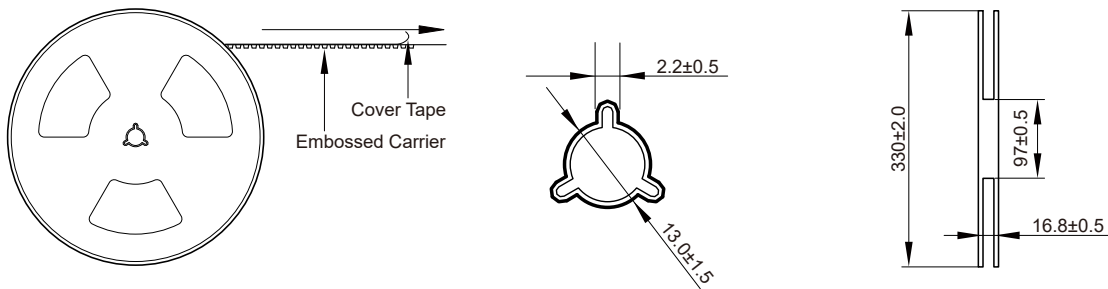

Packaging Quantity:

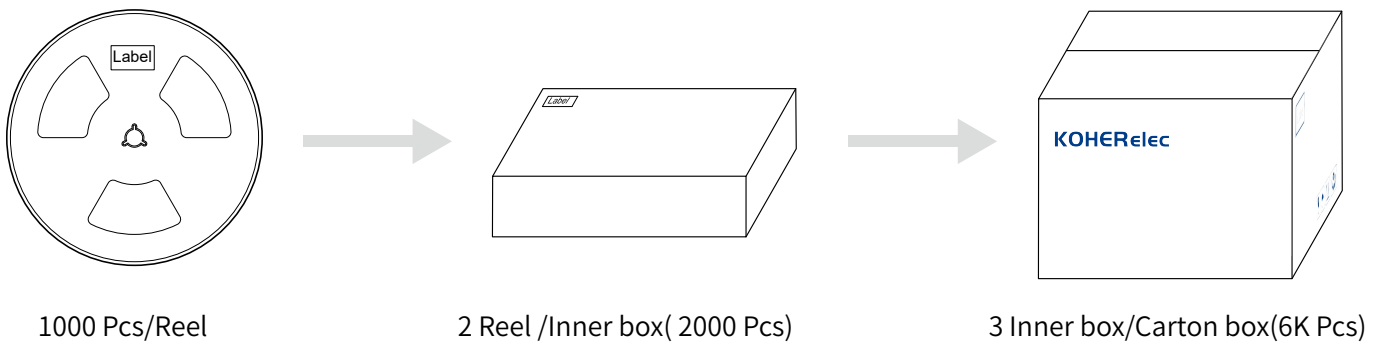

Cautions and Warnings:

Storage Conditions :

- The storage period is within 12 months after the completion of production. Be sure to follow the storage conditions (temperature: -5 to 35°C, humidity: 75% RH Max).If the storage period elapses, the soldering of the terminal electrodes may deteriorate.The warranty period is one year.
- Product should not be exposed to environment with high temperature, high humidity, dust, corrosive gas and etc.
- Products should be handled with care to avoid damage or contamination from perspiration and skin oils.
- Please always handle products carefully to prevent any damage caused by dropping down or inappropriate removing.

Operation Instructions:

- Self heating (temperature increase) occurs when the power is turned ON, so the tolerance should be sufficient for the set thermal design.
- Before soldering, be sure to preheat components.The preheating temperature should be set so that the temperature difference between the solder temperature and chip temperature does not exceed 150°C.
- Soldering corrections after mounting should be within the range of the conditions determined in the specifications.If overheated, a short circuit, performance deterioration, or lifespan shortening may occur.
- Generally, Koher might not be familiar with either customer's specific application or actual requests as customer does.As a result customer shall be responsible for checking and confirming whether Koher product with the performance described in the product specification is suitable for using in customer's particular application or not.

## Looking for pricing, stock, or lifecycle information?

Click below to explore more details on WIN SOURCE:

- ⊖ [View MDA7030-1R2M on WIN SOURCE](#)
- ⊖ [KOHERShanghaiElectronics Co.,Ltd Information](#)

## Optimize Your Supply Chain with WIN SOURCE Solutions

- ✓ Global Sourcing Solution
- ✓ Obsolete Management
- ✓ Cost Control Management
- ✓ Shortage Management
- ✓ Alternative Solution
- ✓ Excess Inventory Management