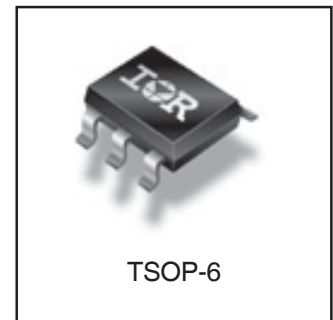
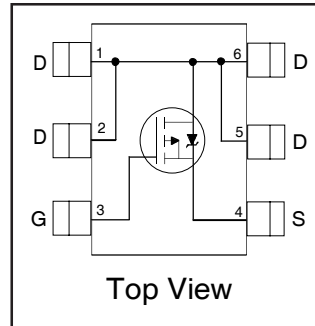


# IRFTS9342PbF

HEXFET® Power MOSFET

$V_{DS}$	<b>-30</b>	<b>V</b>
$V_{GS\ max}$	<b>±20</b>	<b>V</b>
$R_{DS(on)\ max}$ (@ $V_{GS} = -10V$ )	<b>40</b>	<b>mΩ</b>
$R_{DS(on)\ max}$ (@ $V_{GS} = -4.5V$ )	<b>66</b>	<b>mΩ</b>
$Q_g\ typ$	<b>12</b>	<b>nC</b>
$I_D$ (@ $T_A = 25^\circ C$ )	<b>-5.8</b>	<b>A</b>



## Applications

- Battery operated DC motor inverter MOSFET
- System/Load Switch

## Features and Benefits

### Features

Industry-Standard TSOP-6 Package
RoHS Compliant Containing no Lead, no Bromide and no Halogen
MSL1, Consumer Qualification

results in  
⇒

### Benefits

Multi-Vendor Compatibility
Environmentally Friendlier
Increased Reliability

Orderable part number	Package Type	Standard Pack		Note
		Form	Quantity	
IRFTS9342TRPbF	TSOP-6	Tape and Reel	3000	

## Absolute Maximum Ratings

	Parameter	Max.	Units
$V_{DS}$	Drain-to-Source Voltage	-30	V
$V_{GS}$	Gate-to-Source Voltage	±20	
$I_D @ T_A = 25^\circ C$	Continuous Drain Current, $V_{GS} @ 4.5V$	-5.8	A
$I_D @ T_A = 70^\circ C$	Continuous Drain Current, $V_{GS} @ 4.5V$	-4.6	
$I_{DM}$	Pulsed Drain Current ①	-46	
$P_D @ T_A = 25^\circ C$	Power Dissipation	2.0	W
$P_D @ T_A = 70^\circ C$	Power Dissipation	1.3	
	Linear Derating Factor	0.02	W/°C
$T_J$	Operating Junction and	-55 to + 150	°C
$T_{STG}$	Storage Temperature Range		

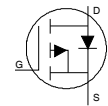
Notes ① through ④ are on page 2

## Static @ $T_J = 25^\circ\text{C}$ (unless otherwise specified)

	Parameter	Min.	Typ.	Max.	Units	Conditions
$BV_{DSS}$	Drain-to-Source Breakdown Voltage	-30	—	—	V	$V_{GS} = 0V, I_D = -250\mu A$
$\Delta BV_{DSS}/\Delta T_J$	Breakdown Voltage Temp. Coefficient	—	19	—	mV/°C	Reference to $25^\circ\text{C}, I_D = -1\text{mA}$
$R_{DS(on)}$	Static Drain-to-Source On-Resistance	—	32	40	mΩ	$V_{GS} = -10V, I_D = -5.8A$ ③
		—	53	66		$V_{GS} = -4.5V, I_D = -4.6A$ ③
$V_{GS(th)}$	Gate Threshold Voltage	-1.3	—	-2.4	V	$V_{DS} = V_{GS}, I_D = -25\mu A$
$\Delta V_{GS(th)}$	Gate Threshold Voltage Coefficient	—	-5.5	—	mV/°C	
$I_{DSS}$	Drain-to-Source Leakage Current	—	—	-1.0	μA	$V_{DS} = -24V, V_{GS} = 0V$
		—	—	-150		$V_{DS} = -24V, V_{GS} = 0V, T_J = 125^\circ\text{C}$
$I_{GSS}$	Gate-to-Source Forward Leakage	—	—	-100	nA	$V_{GS} = -20V$
	Gate-to-Source Reverse Leakage	—	—	100		$V_{GS} = 20V$
$g_{fs}$	Forward Transconductance	6.8	—	—	S	$V_{DS} = -10V, I_D = -4.6A$
$Q_g$	Total Gate Charge	—	12	—	nC	$V_{DS} = -15V$
$Q_{gs}$	Gate-to-Source Charge	—	1.8	—		$V_{GS} = -10V$
$Q_{gd}$	Gate-to-Drain Charge	—	3.1	—		$I_D = -4.6A$
$R_G$	Gate Resistance	—	17	—	Ω	
$t_{d(on)}$	Turn-On Delay Time	—	4.6	—	ns	$V_{DD} = -15V, V_{GS} = -10V$ $I_D = -4.6A$ $R_G = 6.8\Omega$
$t_r$	Rise Time	—	13	—		
$t_{d(off)}$	Turn-Off Delay Time	—	45	—		
$t_f$	Fall Time	—	28	—		
$C_{iss}$	Input Capacitance	—	595	—	pF	$V_{GS} = 0V$
$C_{oss}$	Output Capacitance	—	133	—		$V_{DS} = -25V$
$C_{riss}$	Reverse Transfer Capacitance	—	85	—		$f = 1.0\text{KHz}$

## Diode Characteristics

	Parameter	Min.	Typ.	Max.	Units	Conditions
$I_S$	Continuous Source Current (Body Diode)	—	—	-2.0	A	MOSFET symbol showing the integral reverse p-n junction diode.
$I_{SM}$	Pulsed Source Current (Body Diode) ①	—	—	-46		
$V_{SD}$	Diode Forward Voltage	—	—	-1.2	V	$T_J = 25^\circ\text{C}, I_S = -4.6A, V_{GS} = 0V$ ③
$t_{rr}$	Reverse Recovery Time	—	20	30	ns	$T_J = 25^\circ\text{C}, I_F = -4.6A, V_{DD} = -24V$
$Q_{rr}$	Reverse Recovery Charge	—	11	17	nC	$di/dt = 100A/\mu s$ ③
$t_{on}$	Forward Turn-On Time	Time is dominated by parasitic inductance				

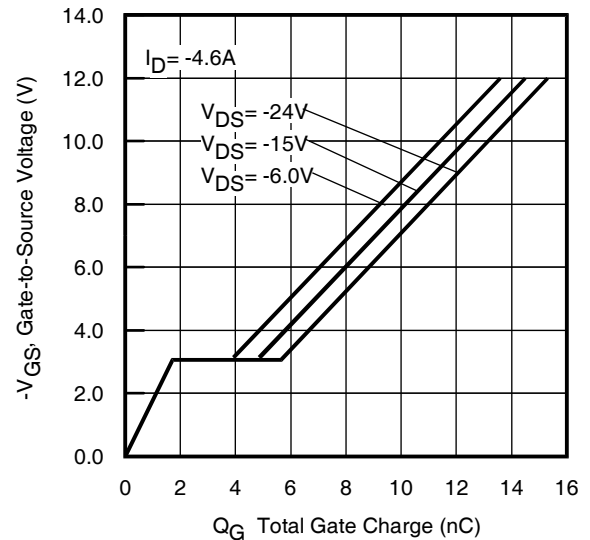
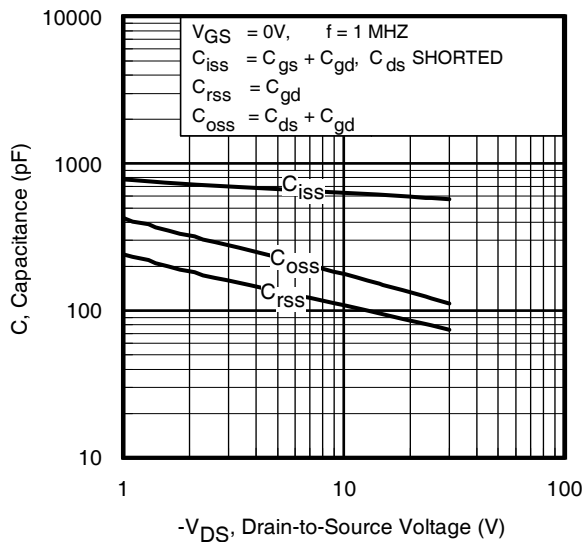
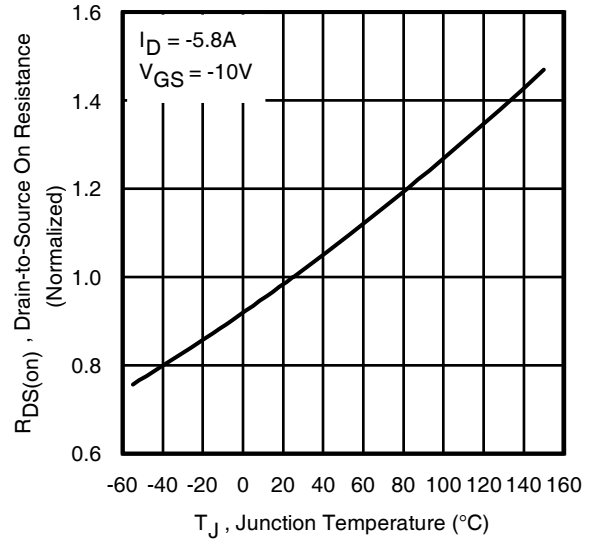
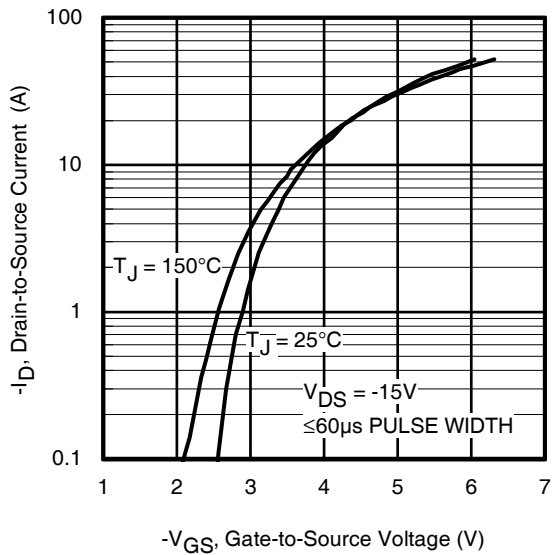
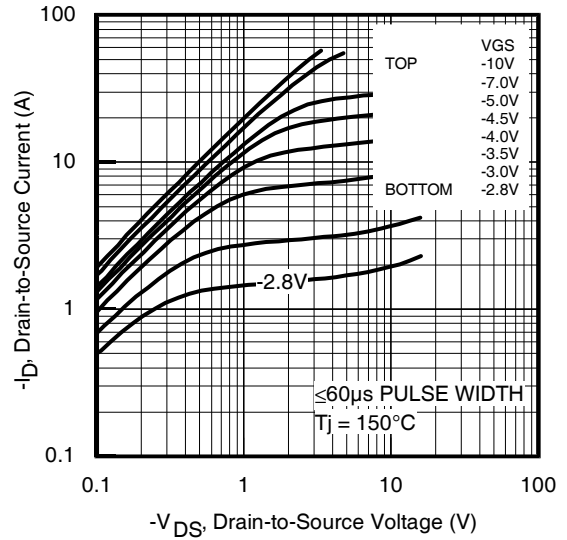
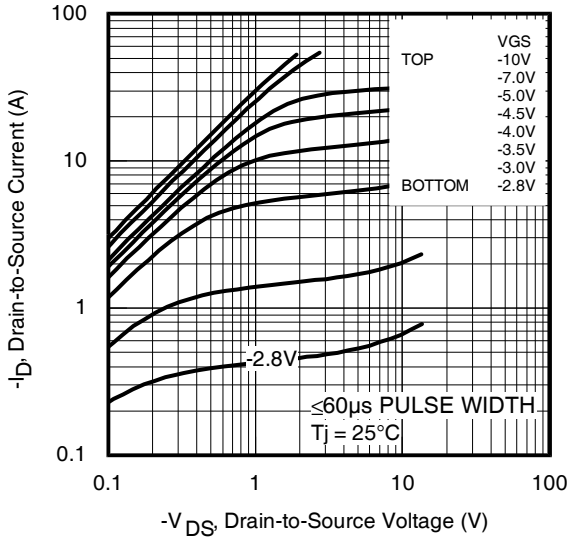


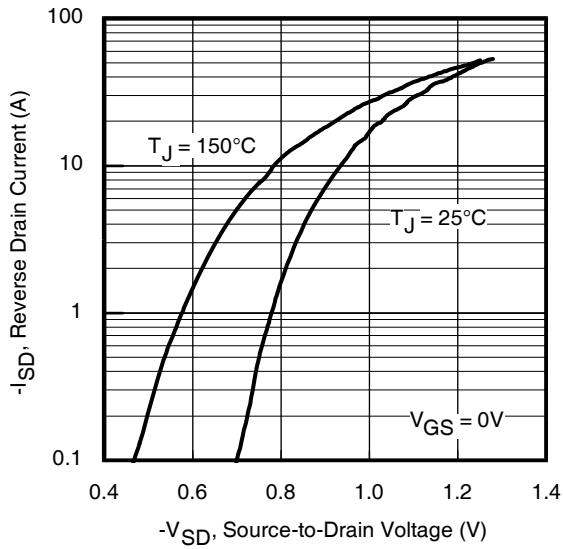
## Thermal Resistance

	Parameter	Typ.	Max.	Units
$R_{\theta JA}$	Junction-to-Ambient ③	—	62.5	°C/W

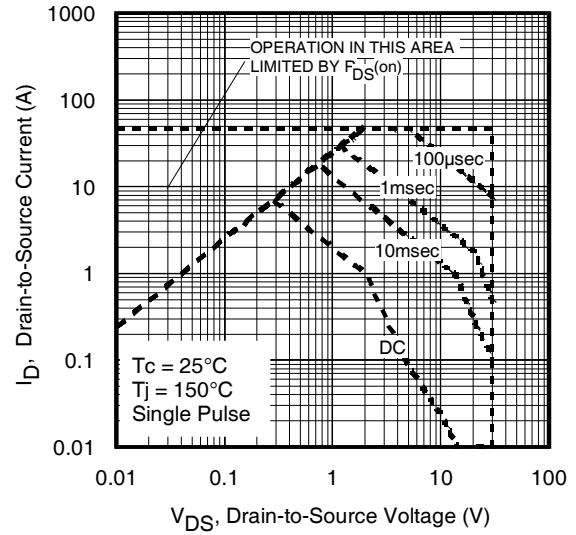
### Notes:

- ① Repetitive rating; pulse width limited by max. junction temperature.
- ② Pulse width  $\leq 400\mu s$ ; duty cycle  $\leq 2\%$ .
- ③ When mounted on 1 inch square copper board.

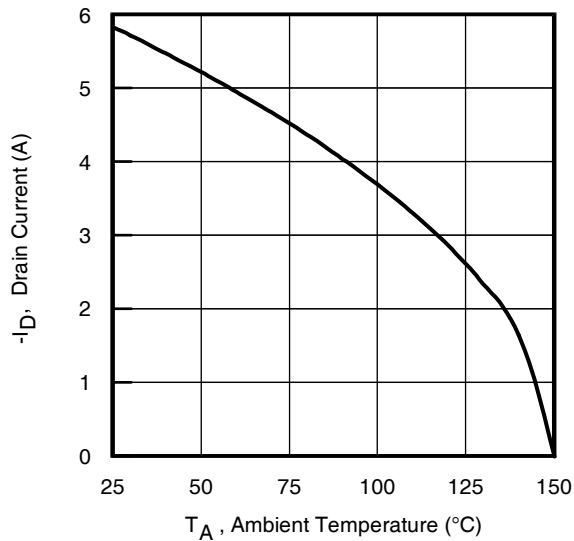




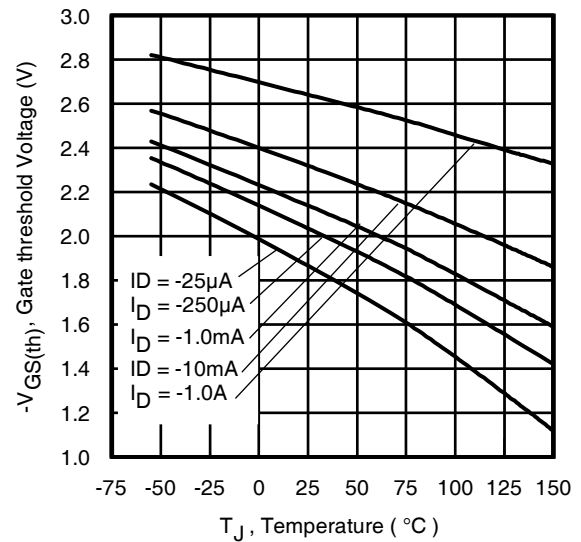
**Fig 7.** Typical Source-Drain Diode Forward Voltage



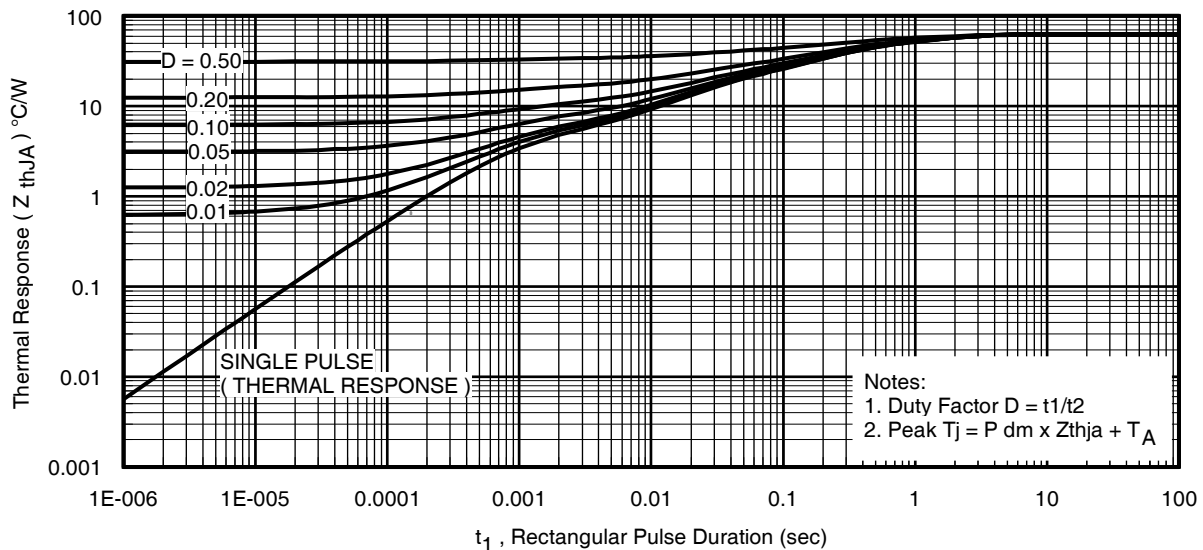
**Fig 8.** Maximum Safe Operating Area



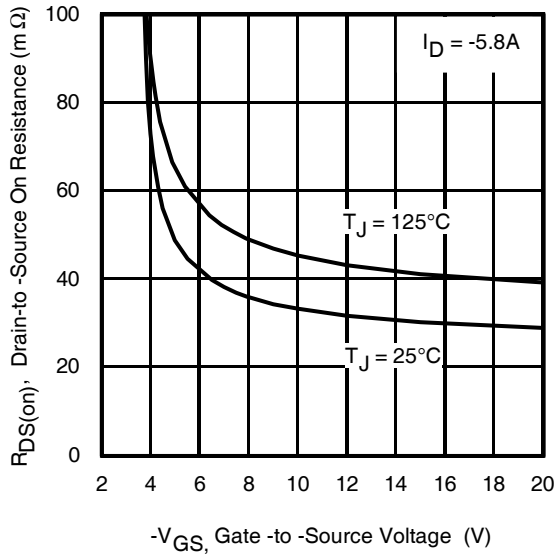
**Fig 9.** Maximum Drain Current vs. Case Temperature



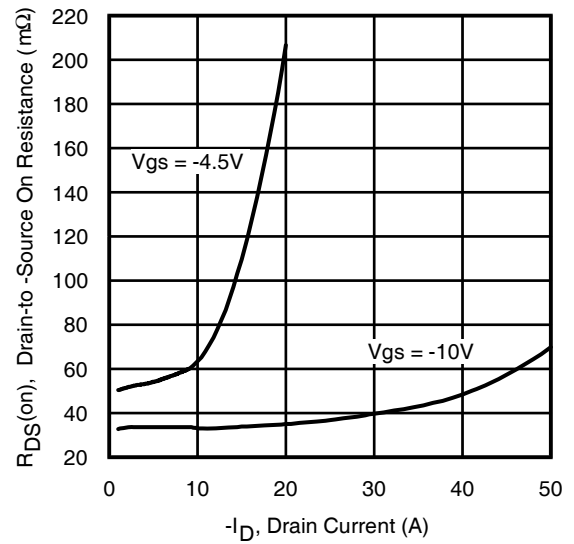
**Fig 10.** Threshold Voltage vs. Temperature



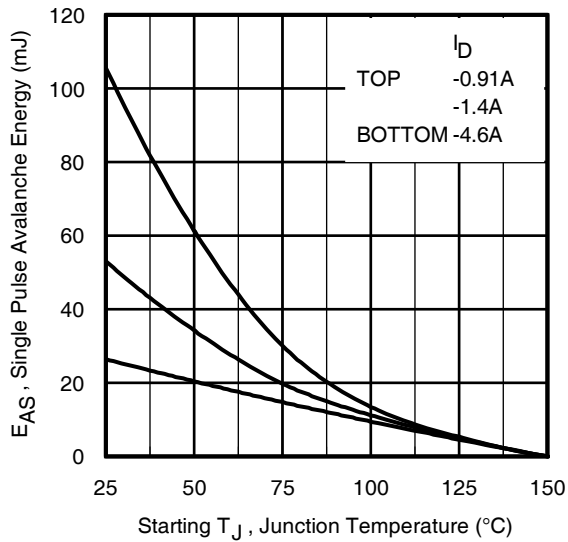
**Fig 11.** Maximum Effective Transient Thermal Impedance, Junction-to-Case



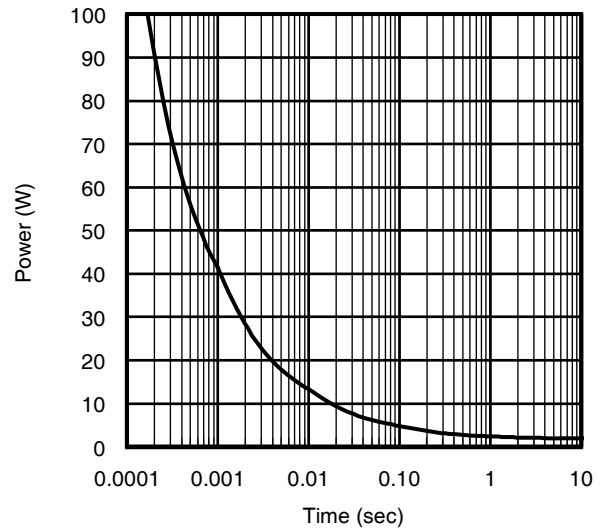
**Fig 12.** On-Resistance vs. Gate Voltage



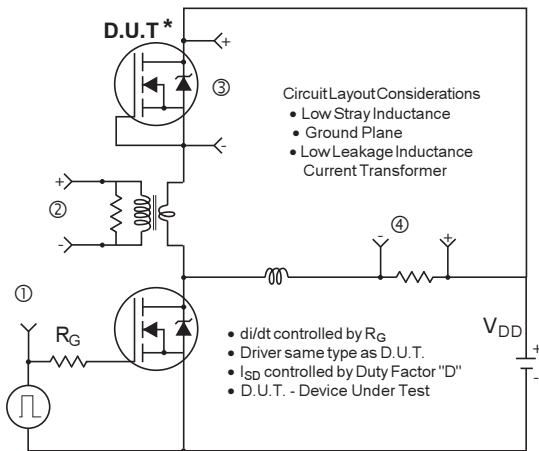
**Fig 13.** Typical On-Resistance vs. Drain Current



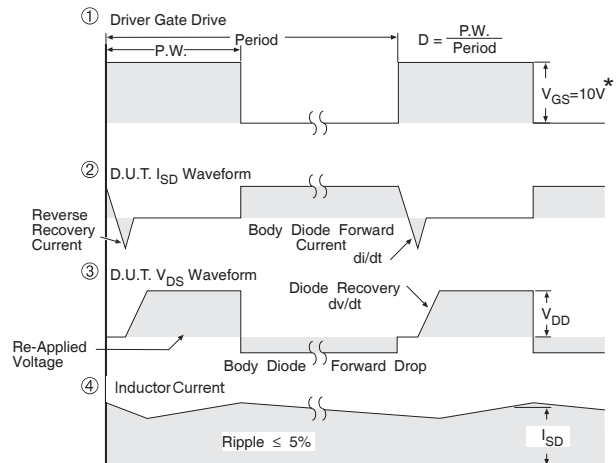
**Fig 14.** Maximum Avalanche Energy vs. Drain Current



**Fig 15.** Typical Power vs. Time

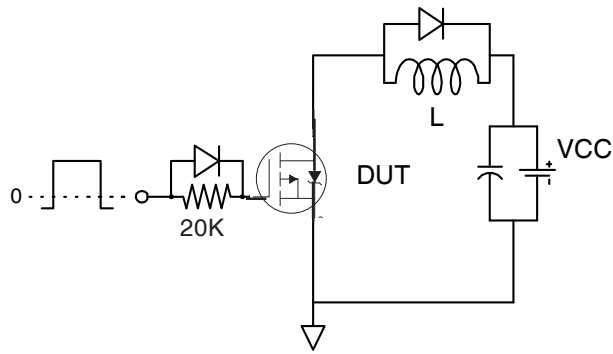


\* Reverse Polarity of D.U.T for P-Channel

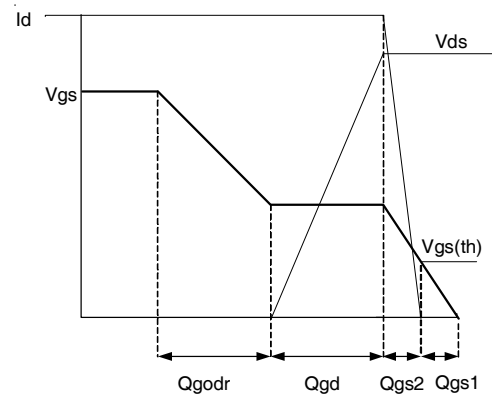


\*  $V_{GS} = 5V$  for Logic Level Devices

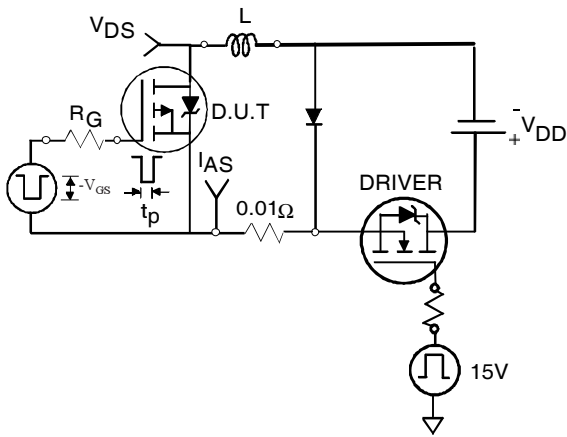
**Fig 16.** Diode Reverse Recovery Test Circuit for P-Channel HEXFET® Power MOSFETs



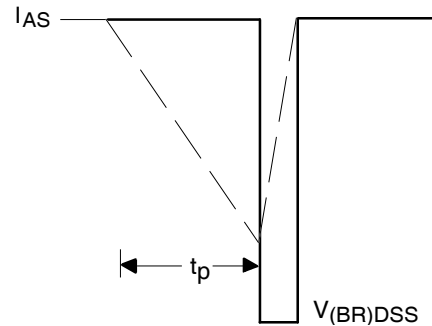
**Fig 17a.** Gate Charge Test Circuit



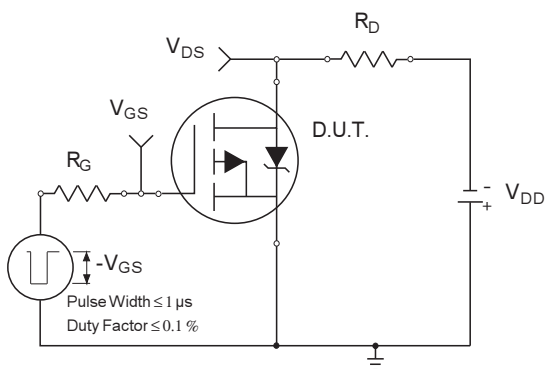
**Fig 17b.** Gate Charge Waveform



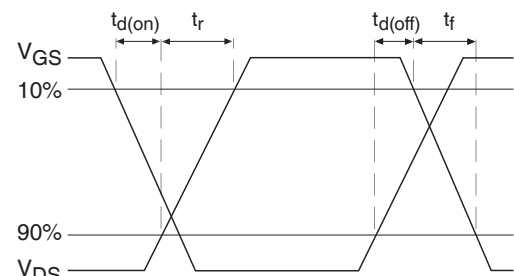
**Fig 18a.** Unclamped Inductive Test Circuit



**Fig 18b.** Unclamped Inductive Waveforms

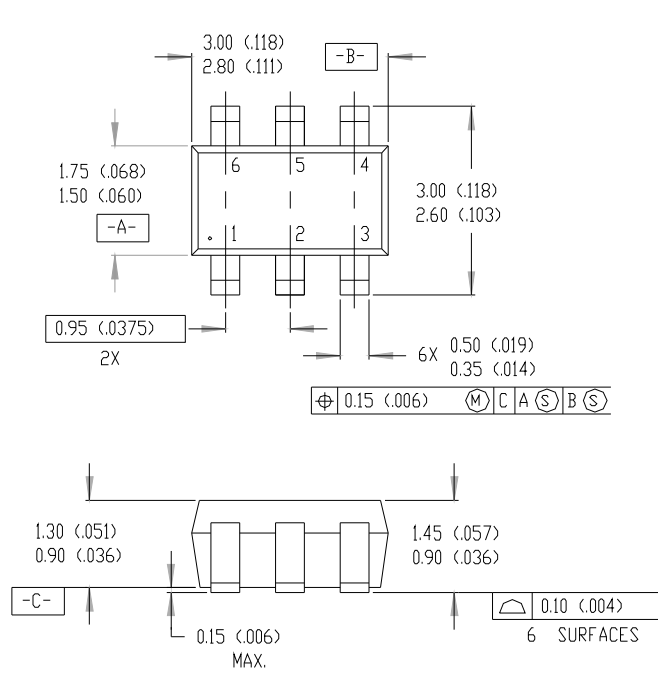


**Fig 19a.** Switching Time Test Circuit

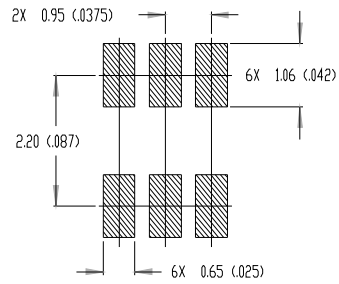


**Fig 19b.** Switching Time Waveforms

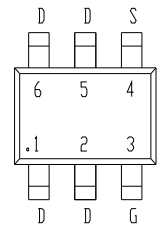
## TSOP-6 Package Outline



### MINIMUM RECOMMENDED FOOTPRINT

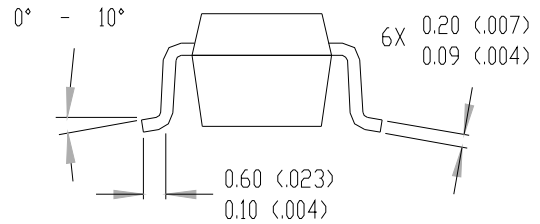


### LEAD ASSIGNMENTS

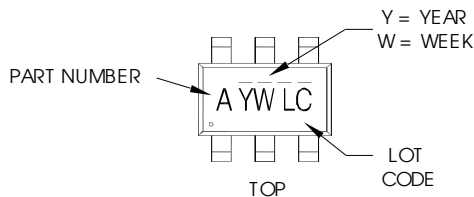


### NOTES:

1. DIMENSIONING & TOLERANCING PER ANSI Y14.5M-1982.
2. CONTROLLING DIMENSION: MILLIMETER.
3. DIMENSIONS ARE SHOWN IN MILLIMETERS (INCHES).



## TSOP-6 Part Marking Information



### PART NUMBER CODE REFERENCE:

A = SI3443DV	O = IRLTS6342TRPBF
B = IRF5800	P = IRFTS8342TRPBF
C = IRF5850	R = IRFTS9342TRPBF
D = IRF5851	S = Not applicable
E = IRF5852	T = IRLTS2242TRPBF
F = IRF5801	
G = IRF5803	
H = IRF5804	
I = IRF5805	
J = IRF5806	
K = IRF5810	
N = IRF5802	

Note: A line above the work week (as shown here) indicates Lead-Free.

### DATE CODE MARKING INSTRUCTIONS

WW = (1-26) IF PRECEDED BY LAST DIGIT OF CALENDAR YEAR

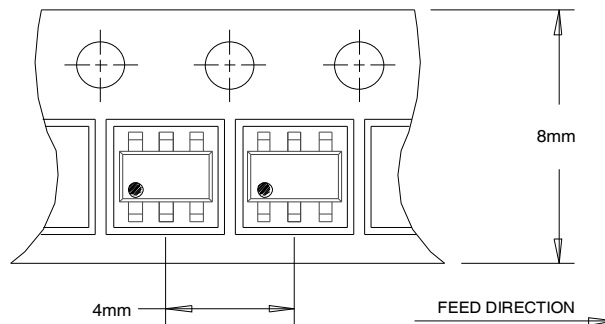
YEAR	Y	WORK WEEK	W
2011	2001	01	A
2012	2002	02	B
2013	2003	03	C
2014	2004	04	D
2015	2005	05	
2016	2006	06	
2017	2007	07	
2018	2008	08	
2019	2009	09	
2020	2010	24	X
		25	Y
		26	Z

WW = (27-52) IF PRECEDED BY A LETTER

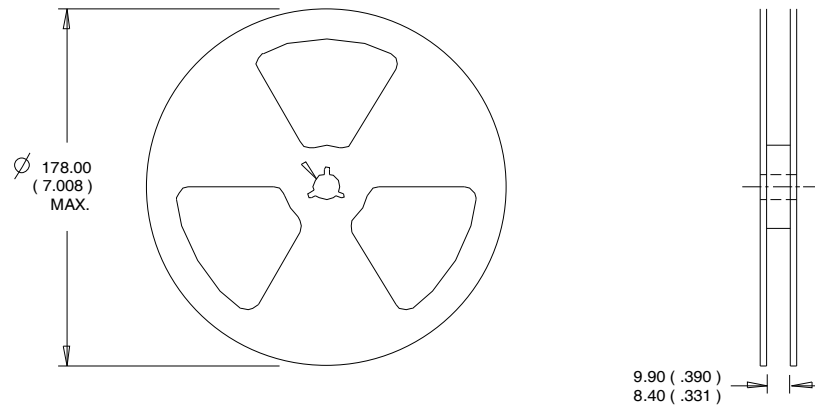
YEAR	Y	WORK WEEK	W
2011	2001	A 27	A
2012	2002	B 28	B
2013	2003	C 29	C
2014	2004	D 30	D
2015	2005	E	
2016	2006	F	
2017	2007	G	
2018	2008	H	
2019	2009	J	
2020	2010	K 50	X
		51	Y
		52	Z

Note: For the most current drawing please refer to IR website at: <http://www.irf.com/package/>

## TSOP-6 Tape and Reel Information



NOTES :  
1. OUTLINE CONFORMS TO EIA-481 & EIA-541.



NOTES:  
1. CONTROLLING DIMENSION : MILLIMETER.  
2. OUTLINE CONFORMS TO EIA-481 & EIA-541.

### Qualification information<sup>†</sup>

Qualification level	Consumer <sup>††</sup> (per JEDEC JESD47F <sup>†††</sup> guidelines )	
Moisture Sensitivity Level	TSOP-6	MSL1 (per IPC/JEDEC J-STD-020D <sup>†††</sup> )
RoHS compliant	Yes	

† Qualification standards can be found at International Rectifier's web site  
<http://www.irf.com/product-info/reliability>

†† Higher qualification ratings may be available should the user have such requirements.  
Please contact your International Rectifier sales representative for further information:  
<http://www.irf.com/whoto-call/salesrep/>

††† Applicable version of JEDEC standard at the time of product release.

Data and specifications subject to change without notice.

International  
**IR** Rectifier

IR WORLD HEADQUARTERS: 101 N. Sepulveda Blvd., El Segundo, California 90245, USA Tel: (310) 252-7105  
TAC Fax: (310) 252-7903

Visit us at [www.irf.com](http://www.irf.com) for sales contact information. 02/2012

## **IMPORTANT NOTICE**

The information given in this document shall in no event be regarded as a guarantee of conditions or characteristics ("Beschaffenheitsgarantie").

With respect to any examples, hints or any typical values stated herein and/or any information regarding the application of the product, Infineon Technologies hereby disclaims any and all warranties and liabilities of any kind, including without limitation warranties of non-infringement of intellectual property rights of any third party.

In addition, any information given in this document is subject to customer's compliance with its obligations stated in this document and any applicable legal requirements, norms and standards concerning customer's products and any use of the product of Infineon Technologies in customer's applications.

The data contained in this document is exclusively intended for technically trained staff. It is the responsibility of customer's technical departments to evaluate the suitability of the product for the intended application and the completeness of the product information given in this document with respect to such application.

For further information on the product, technology, delivery terms and conditions and prices please contact your nearest Infineon Technologies office ([www.infineon.com](http://www.infineon.com)).

## **WARNINGS**

Due to technical requirements products may contain dangerous substances. For information on the types in question please contact your nearest Infineon Technologies office.

Except as otherwise explicitly approved by Infineon Technologies in a written document signed by authorized representatives of Infineon Technologies, Infineon Technologies' products may not be used in any applications where a failure of the product or any consequences of the use thereof can reasonably be expected to result in personal injury.

## Looking for pricing, stock, or lifecycle information?

Click below to explore more details on WIN SOURCE:

 [View IRFTS9342](#) on WIN SOURCE

 [Infineon Technologies](#) Information

## Optimize Your Supply Chain with WIN SOURCE Solutions

-  Global Sourcing Solution
-  Obsolete Management
-  Cost Control Management
-  Shortage Management
-  Alternative Solution
-  Excess Inventory Management