

FEATURES

- ※BCD, Hexadecimal
- ※Cross-head& Flat-head Actuator
- ※Washable

APPLICATION

- ※Steering system
- ※White goods
- ※Wireless microphone

SPECIFICATION

Contact Rating	150mA, 24V DC
Contact Resistance	80mΩ max.
Insulation Resistance	100MΩ min. 250V DC
Dielectric Strength	250V AC/1 minute
Operating Force	400gf·cm max.
Operating Life	10,000 steps
Operating Temp.	-60°C ~ +125°C
Storage Temp.	-60°C ~ +125°C

HOW TO ORDER

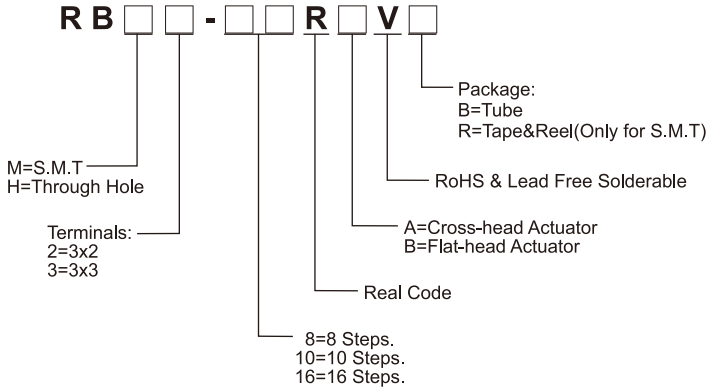

PACKAGE

<Tube>
47 pcs
<Tape & Reel>
RBM: 450 pcs.

ROTARY CODED SWITCH

RBH3-□□RA

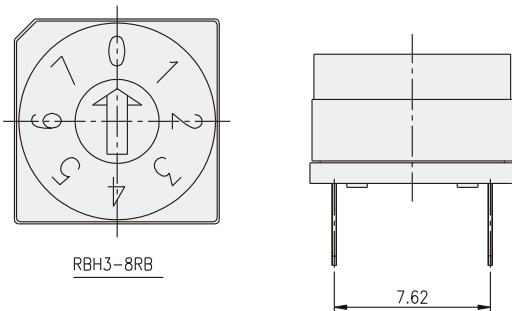
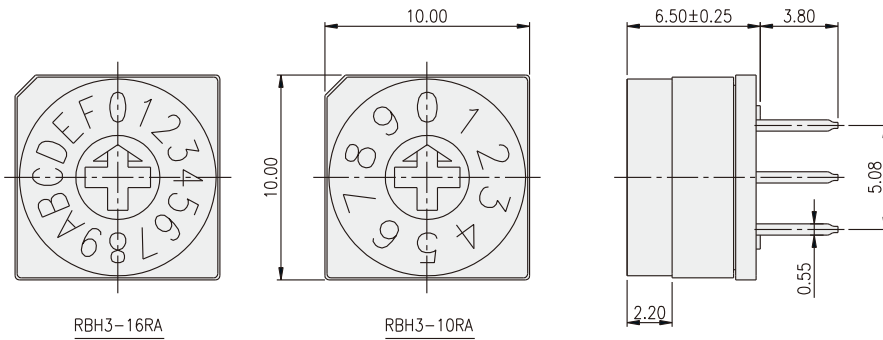

TYPE	POSITION	CODE			
		1	2	4	8
10R 08R	0	●	●	●	●
	1	○	●	●	●
	2	●	○	●	●
	3	○	○	●	●
	4	●	●	○	●
	5	○	●	○	●
	6	●	○	○	●
	7	○	○	○	●
	8	●	●	●	○
	9	○	○	●	○
16R	A	●	○	●	○
	B	○	○	●	○
	C	●	●	○	○
	D	○	●	○	○
	E	●	○	○	○
	F	○	○	○	○

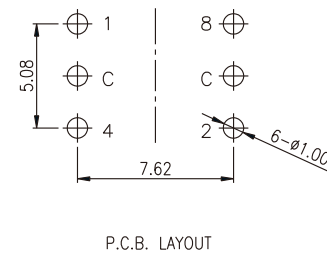

RBH2-□□RB

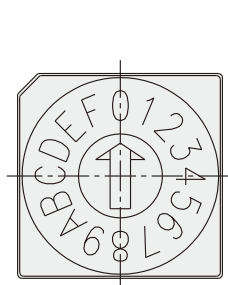

RBH2-16RB

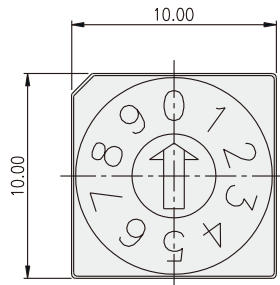

RBH2-10RB

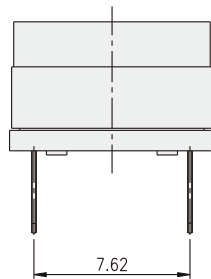
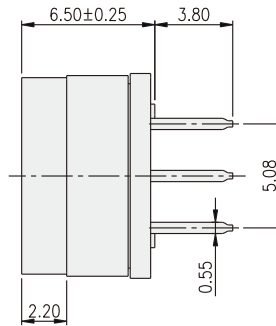

○ ON
● OFF

TYPE	POSITION	CODE			
		1	2	4	8
10R	0	●	●	●	●
	1	○	○	●	●
	2	●	○	○	●
	3	○	○	●	●
	4	●	●	○	●
	5	○	○	○	●
	6	●	○	○	○
	7	○	○	○	●
	8	○	●	●	○
	9	●	●	●	○
16R	A	●	○	●	○
	B	○	○	●	○
	C	●	●	○	○
	D	○	●	○	○
	E	●	○	○	○
	F	○	○	○	○

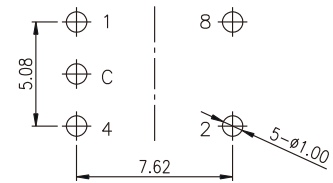

P.C.B. LAYOUT

RBM3-□□RB

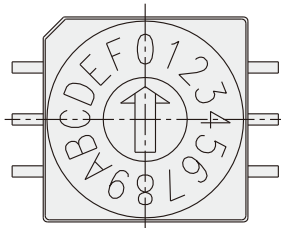

RBM3-16RB

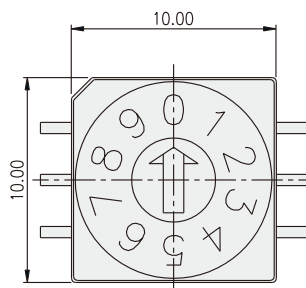

RBM3-10RB

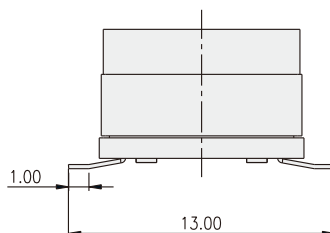
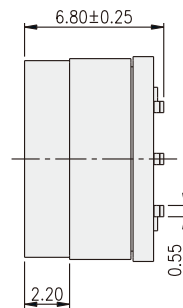

○ ON
● OFF

TYPE	POSITION	CODE			
		1	2	4	8
10R	0	●	●	●	●
	1	○	●	●	●
	2	●	○	●	●
	3	○	○	●	●
	4	○	○	○	●
	5	○	●	○	●
	6	●	○	○	○
	7	○	○	○	○
	8	○	●	●	○
	9	○	●	●	○
16R	A	○	○	●	○
	B	○	○	●	○
	C	●	●	○	○
	D	○	●	○	○
	E	●	○	○	○
	F	○	○	○	○

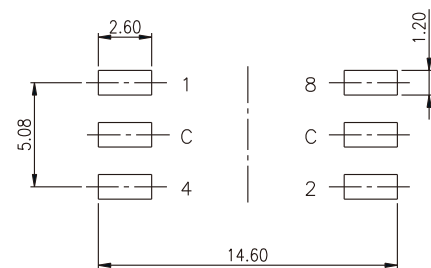

P.C.B. LAYOUT

Mouser Electronics

Authorized Distributor



Click to View Pricing, Inventory, Delivery & Lifecycle Information:

Diptronics:







[RBM3-10RAVB](#) [RBH3-16RAVB](#) [RBM3-16RBVB](#) [RBH3-10RAVB](#) [RBM3-10RBVR](#) [RBH2-16RAVB](#) [RBM3-10RAVR](#)
[RBH3-16RBVB](#) [RBM3-16RAVR](#) [RBM3-10RBVB](#) [RBH2-10RAVB](#) [RBM3-16RBVR](#) [RBH3-10RBVB](#) [RBM3-16RAVB](#)
[RBH2-10RBVB](#) [RBH2-16RBVB](#)

Looking for pricing, stock, or lifecycle information?

Click below to explore more details on WIN SOURCE:

-  [View RBM3-16RBVR on WIN SOURCE](#)
-  [Diptronics Information](#)

Optimize Your Supply Chain with WIN SOURCE Solutions

-  Global Sourcing Solution
-  Obsolete Management
-  Cost Control Management
-  Shortage Management
-  Alternative Solution
-  Excess Inventory Management