

Product Description

Qorvo's QPA0001 is a packaged driver amplifier fabricated on Qorvo's 0.15 μm QGaN15 on SiC process. Operating from 8.5 to 10.5 GHz, the QPA0001 can deliver 2 W saturated output power, 50 % power-added efficiency and 27 dB of large signal gain.

QPA0001 incorporates active bias control to provide customers with bias point stability while reducing system complexity.

The QPA0001 is available in a 4x3 mm mold encapsulated QFN. With a compact size, it can support tight lattice spacing requirements for phased array radar applications.

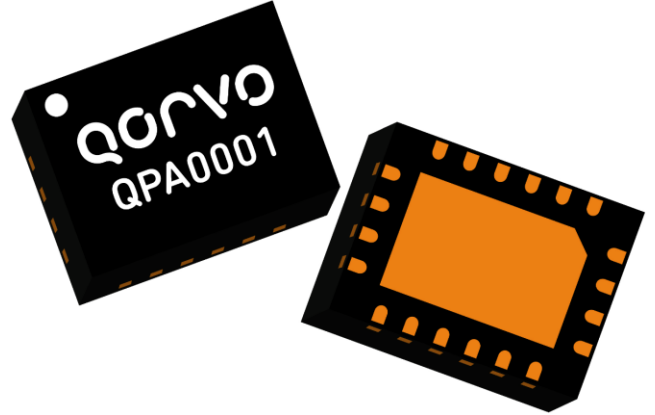

Product Features

- Frequency Range: 8.5 – 10.5 GHz
- Small Signal Gain: 33 dB (mid-band)
- Pout: 33 dBm ($P_{IN} = 6$ dBm)
- Large Signal Gain: 27 dB (@ $P_{in} = 6$ dBm)
- PAE: 50 % Pulse Mode
- Input Return Loss: 12 dB
- Output Return Loss: 10 dB
- Harmonic: -20 dBc (@ $P_{in} = 6$ dBm)
- Active Bias Control: $V_D = 16$ V, $I_{DQ} = 55$ mA typical
- Package Dimensions: 4.0 x 3.0 x 0.65 mm

Functional Block Diagram

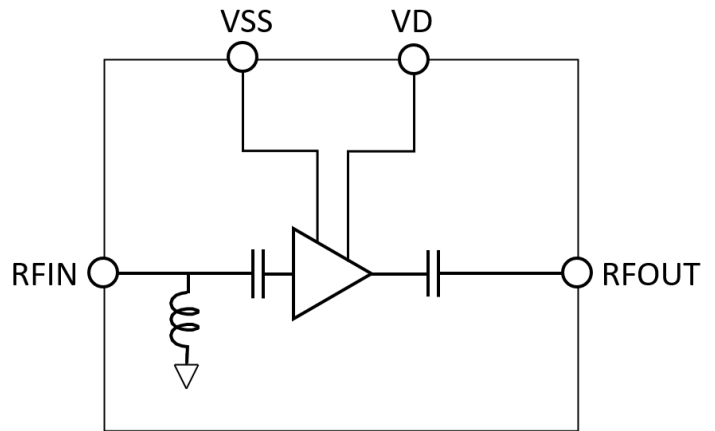

Applications

- Commercial and military radar
- Communications

Ordering Information

Part No.	Description
QPA0001	Shipping Tray, Qty 50
QPA0001TR7	Tape and Reel 7", Qty 250
QPA0001EVB01	QPA0001 Evaluation Board, Qty 1

Recommended Operating Conditions

Parameter	Min	Typ	Max	Units
Drain Voltage (VD)		16		V
Drain Current (IDQ, self-bias, values are typical)		55		mA
Drain Current Under RF Drive		See plots		mA
Active Gate Control Voltage (Vss)	-3.3	-3	-2.7	V
Active Gate Control Current Under RF Drive		See plots		mA
Temperature (TBASE)	-40		+85	°C

Electrical performance is measured under conditions noted in the electrical specifications table. Specifications are not guaranteed over all recommended operating conditions.

Electrical Specifications

Parameter ^{1, 3}	Min	Typ	Max	Units
Operational Frequency Range	8.5		10.5	GHz
Small Signal Gain		33		dB
Input Return Loss		12		dB
Output Return Loss		10		dB
Output Power (@ Pin = 6 dBm) ²		33		dBm
Power Added Efficiency (@ Pin = 6 dBm) ²		50		%
Large Signal Gain (@ Pin = 6 dBm) ²		27		dB
2 nd Harmonic Suppression (@ Pin = 6 dBm)		-20		dBc
3 rd harmonic Suppression (@ Pin = 6 dBm)		-35		dBc
Small Signal Gain Temperature Coefficient		-0.15		dB/°C

1 Test conditions unless otherwise noted: T_{BASE} = +25 °C, V_D = +16 V, IDQ = 55 mA typical, V_{ss} = -3.0 V.

2. Power tested under pulse mode, PW = 100uS, DC = 10%.

3. Data de-embedded of fixture losses.

Absolute Maximum Ratings

Parameter	Min Value	Max Value	Units
Drain Voltage (VD)	-	29.5	V
Gate Voltage Range (Vss)	-4	-2.5	V
Drain Current (IDS)	-	700	mA
Active Gate Control Current (IVss)	-	10	mA
Input Power (PIN), CW, 50 Ω, 85 °C,	-	30	dBm
Input Power (PIN), CW, Output VSWR 3:1, 85 °C	-	30	dBm
Mounting Temperature (30 Seconds)	-	260	°C
Storage Temperature	-55	150	°C

Operation of this device outside the parameter ranges given above may cause permanent damage. These are stress ratings only, and functional operation of the device at these conditions is not implied. Extended application of Absolute Maximum Rating conditions to the device may reduce device reliability.

Thermal and Reliability Information

Parameter	Values	Units	Conditions
Under Drive, Thermal Resistance (θ_{JC}) ^(1,2,3)	11.4	°C/W	T _{BASE} = 85 °C, V _D = +16 V, Pulse Mode, 100uS, 10% Freq = 10.25 GHz, I _{DS_DRIVE} = 221 mA P _{IN} = +6 dBm, P _{OUT} = +32.4 dBm, P _{DISS} = 1.80 W
Channel Temperature (T _{CH}) ²	105.5	°C	

Notes:

1. Thermal resistance is referenced to the package backside.
2. Base or ambient temperature is 85 °C, channel temperature is IR scan equivalent.
3. Refer to the following document for more information:

[GaN Device Channel Temperature, Thermal Resistance, and Reliability Estimates](#)

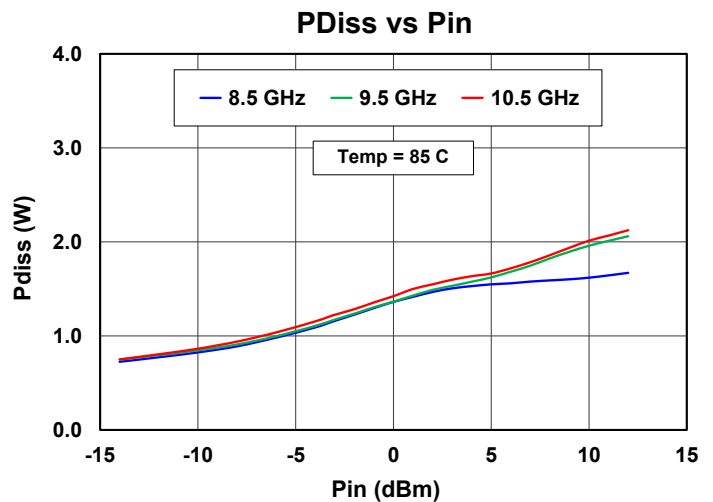
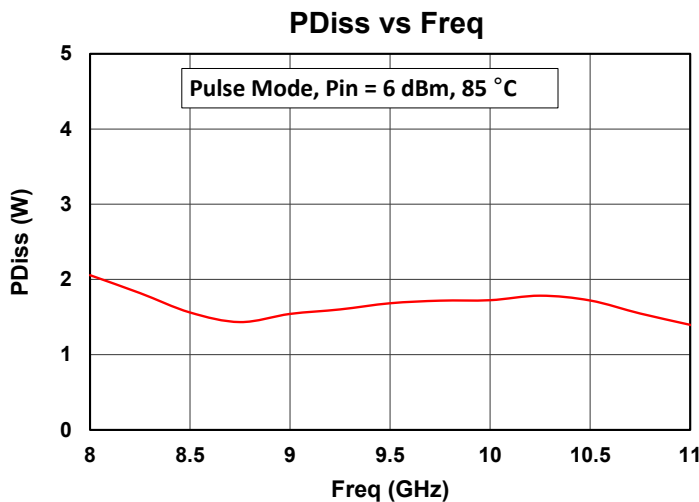

Performance Plots – Small Signal

Test conditions unless otherwise specified: $V_D = 16\text{ V}$, $V_{SS} = -3\text{ V}$, $25\text{ }^\circ\text{C}$

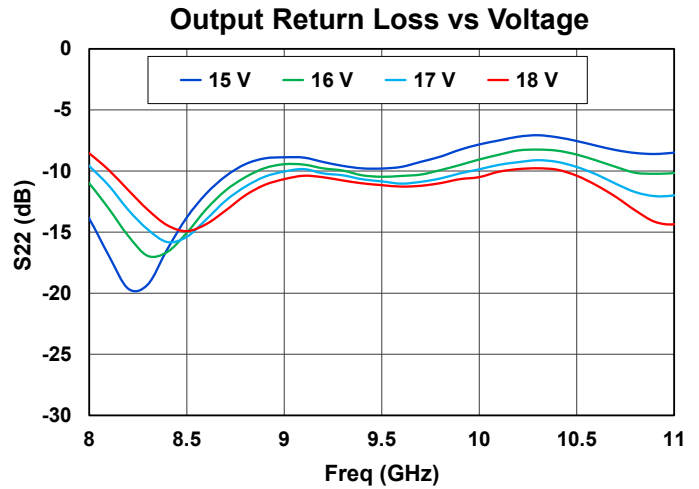
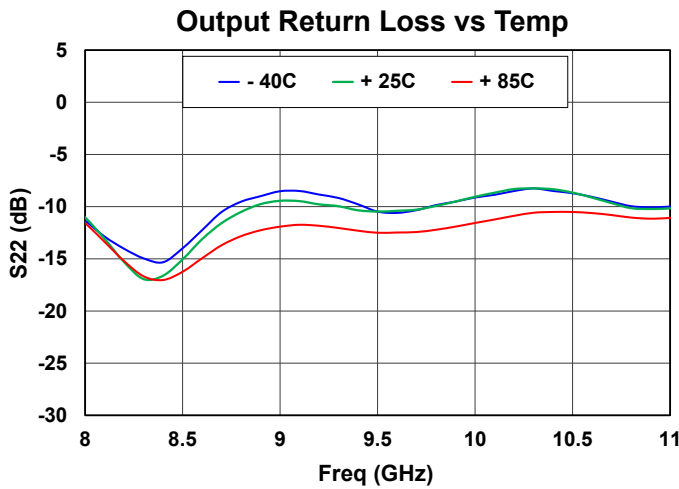
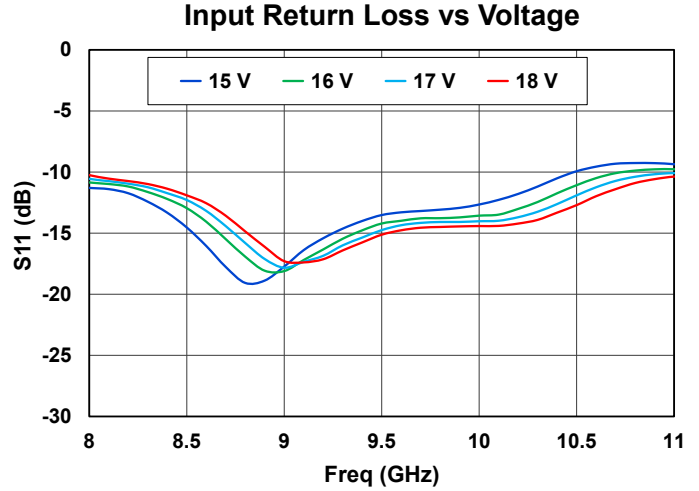
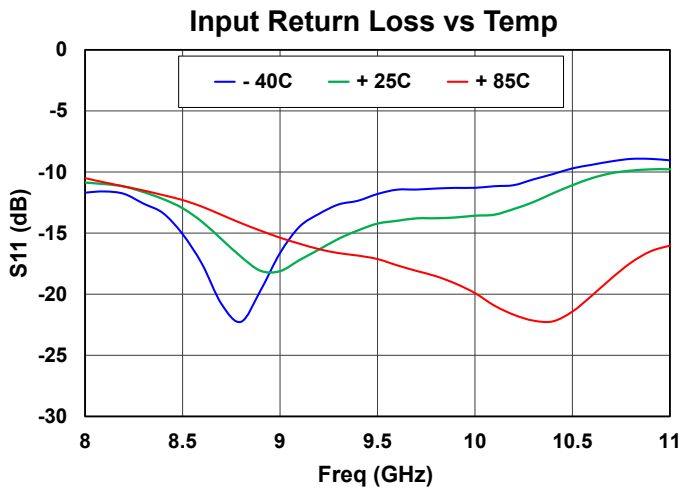
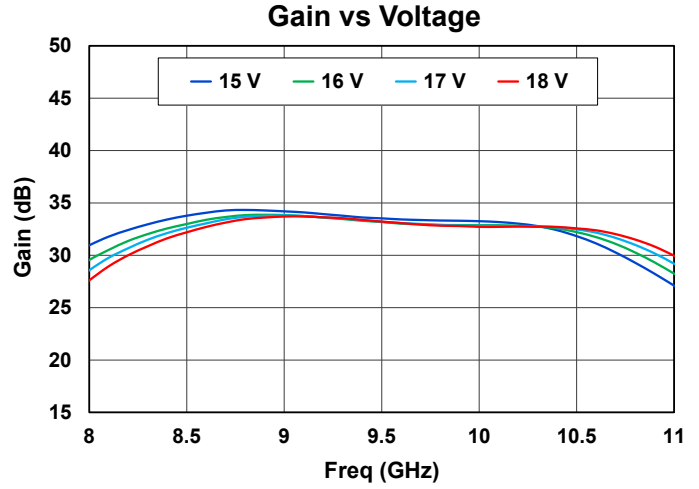
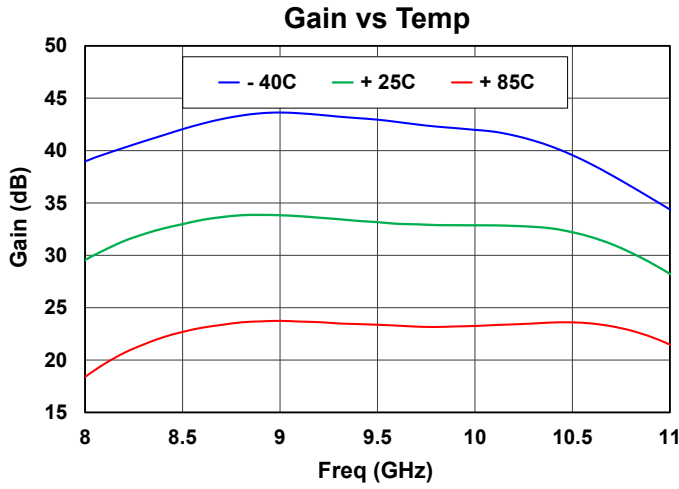

Performance Plots, Large Signal

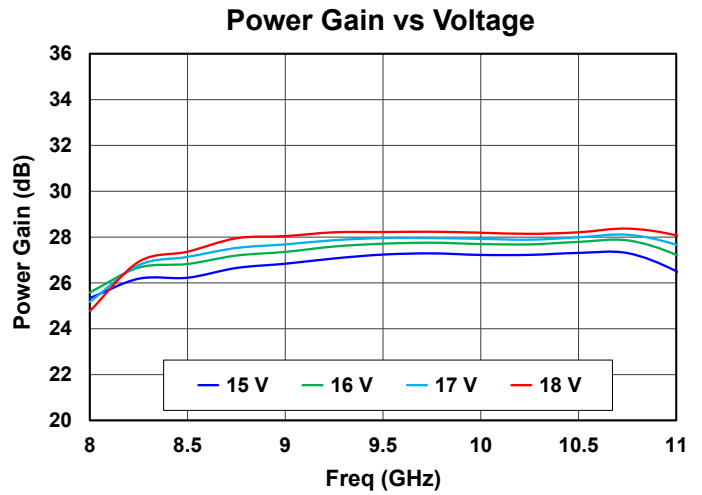
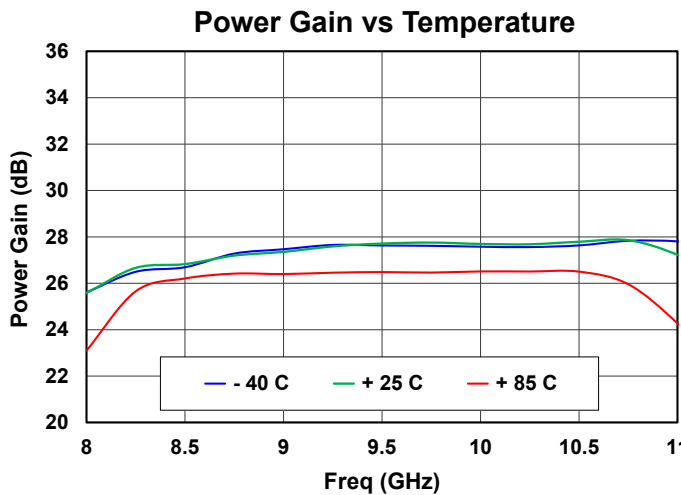
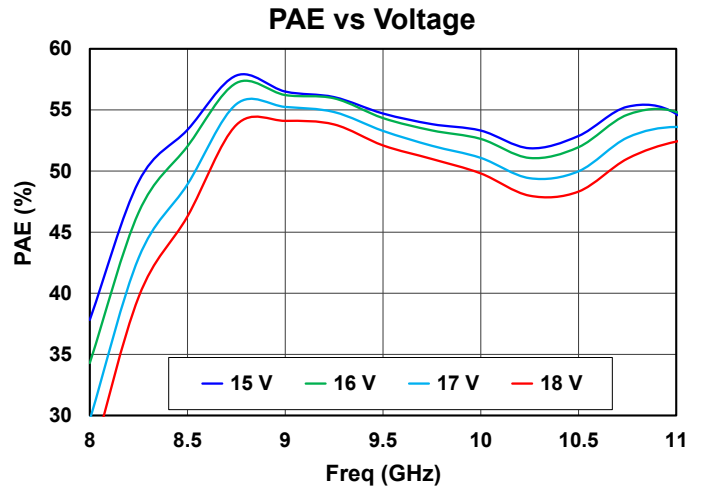
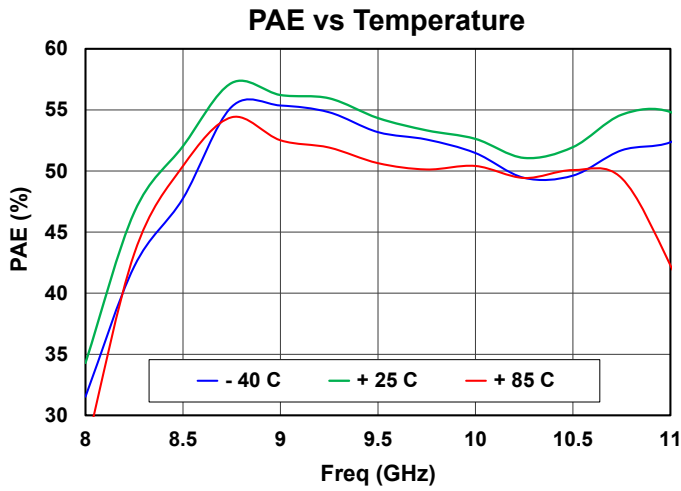
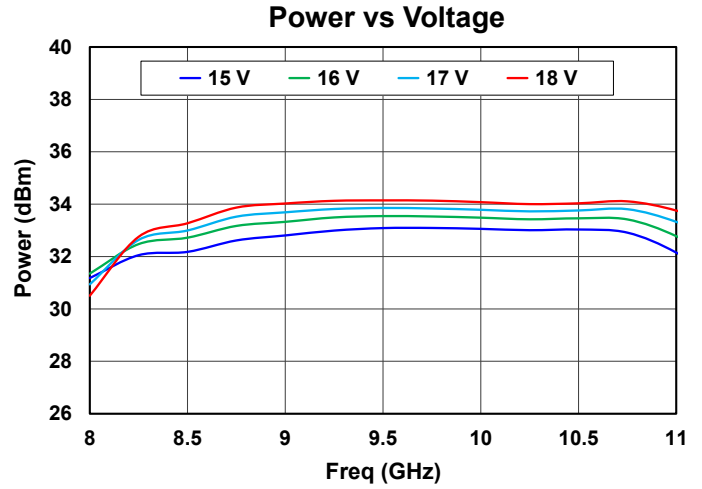
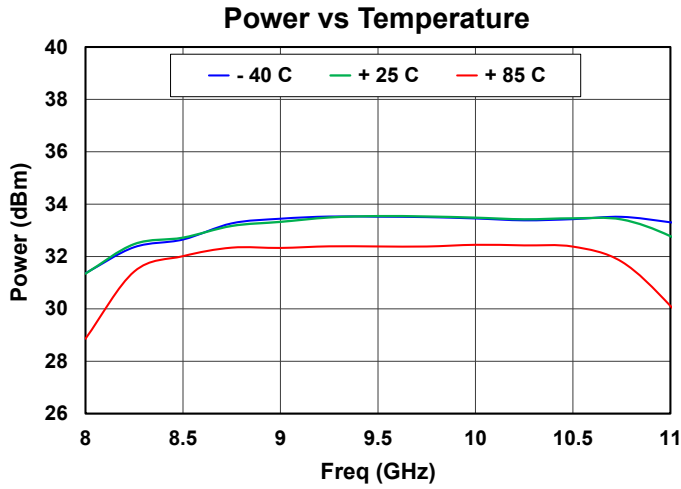
 Test Conditions unless otherwise stated: $V_D = 16\text{ V}$, $V_{SS} = -3\text{ V}$, Pulse Pin = 6 dBm, PW = 100 μs , DC = 10%, 25 °C

Power Sweep

Test Conditions unless otherwise stated: $V_D = 16\text{ V}$, $V_{SS} = -3\text{ V}$, Pulse Mode, $PW = 100\text{ }\mu\text{s}$, $DC = 10\%$, $25\text{ }^\circ\text{C}$

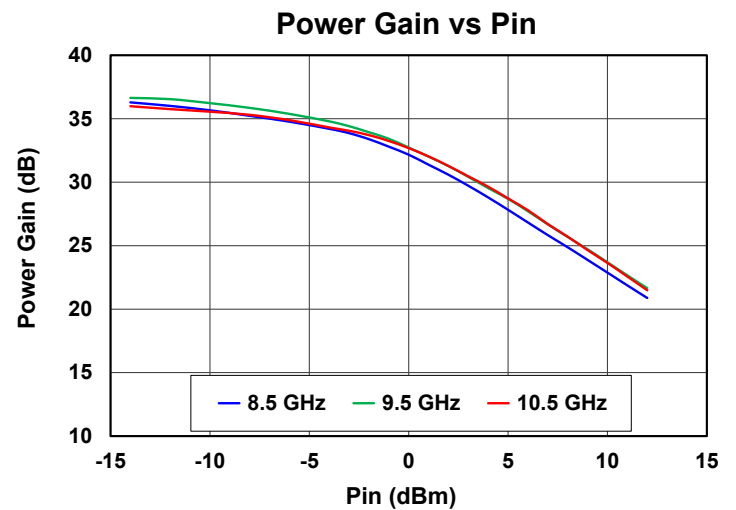
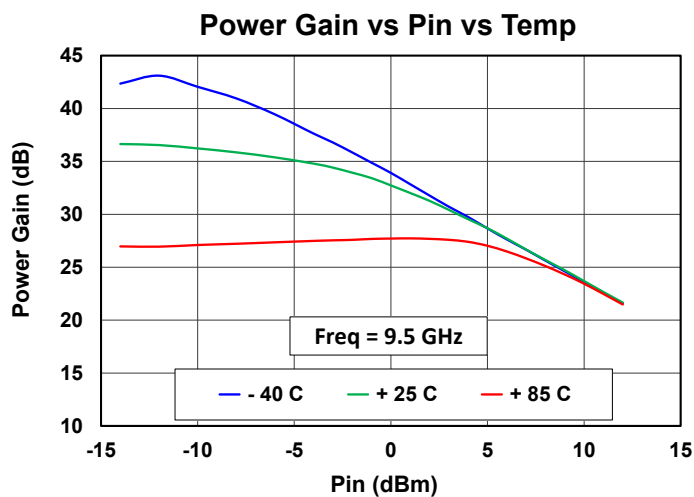
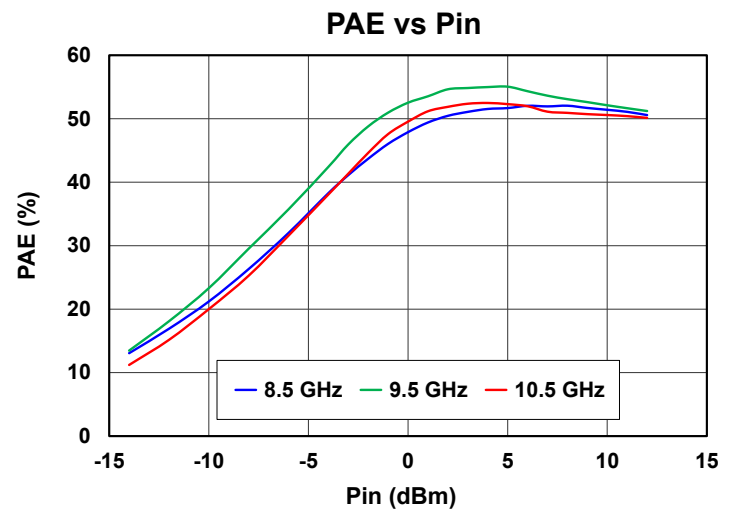
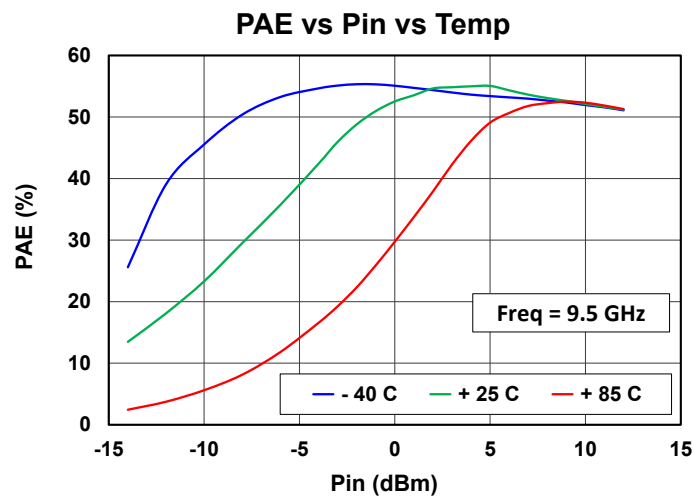
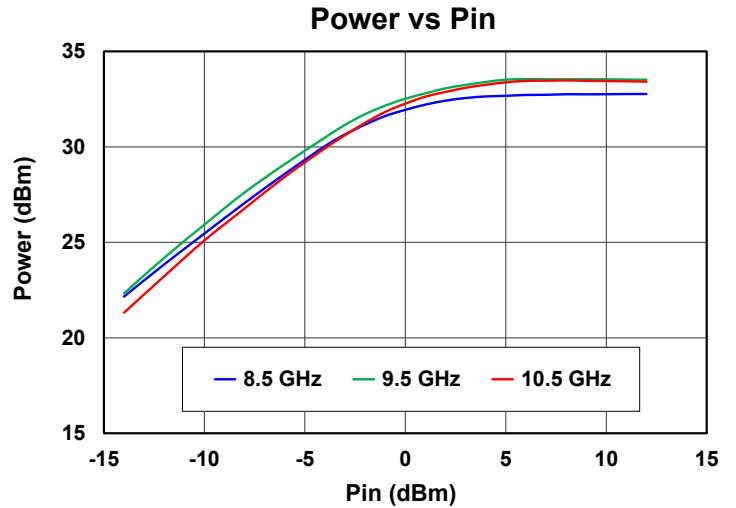
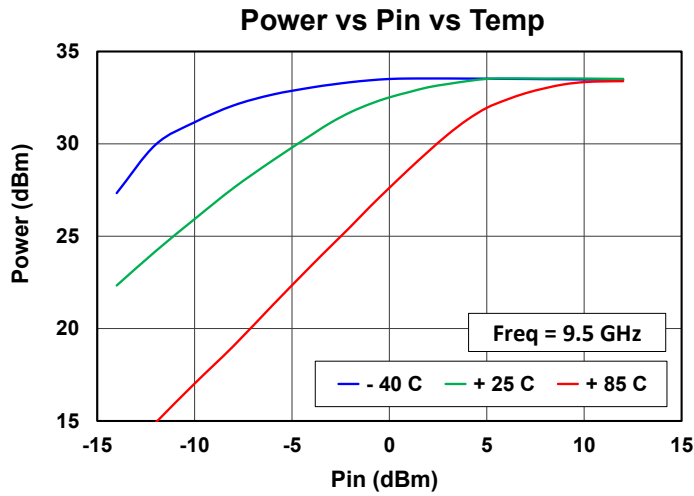

Power Sweep

Test Conditions unless otherwise stated: $V_D = 16\text{ V}$, $V_{SS} = -3\text{ V}$, Pulse $P_{in} = 6\text{ dBm}$, $PW = 100\text{ }\mu\text{s}$, $DC = 10\%$, $25\text{ }^\circ\text{C}$

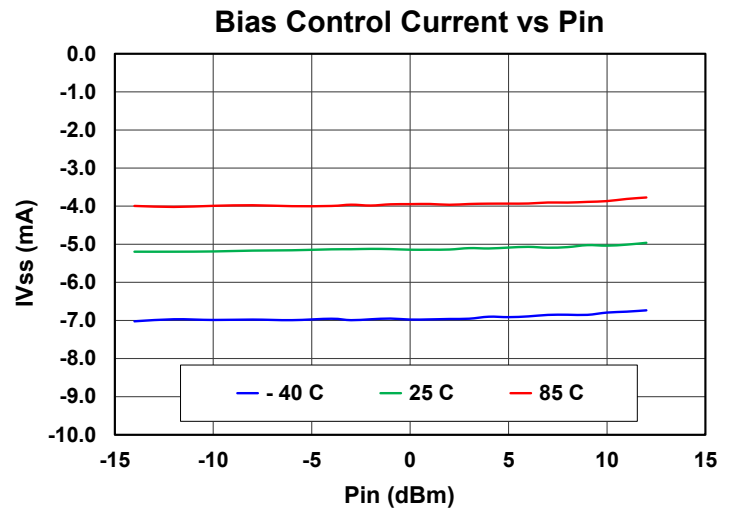
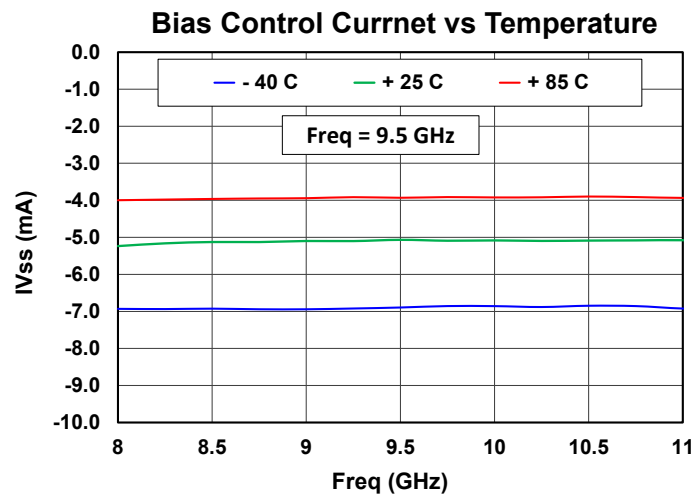
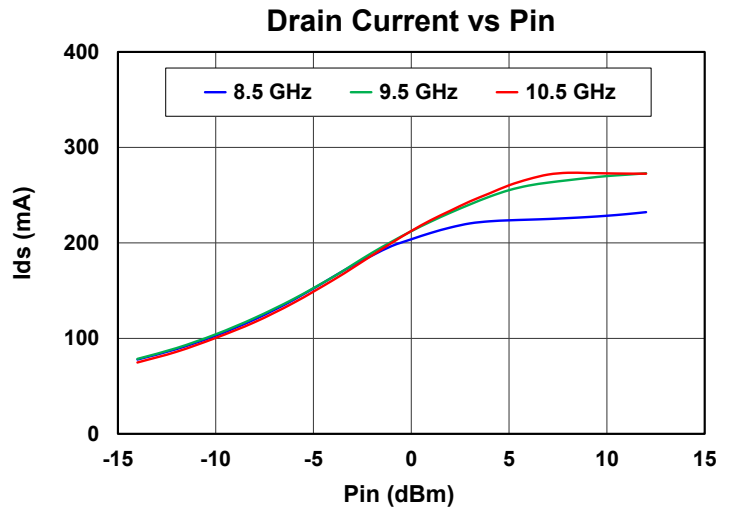
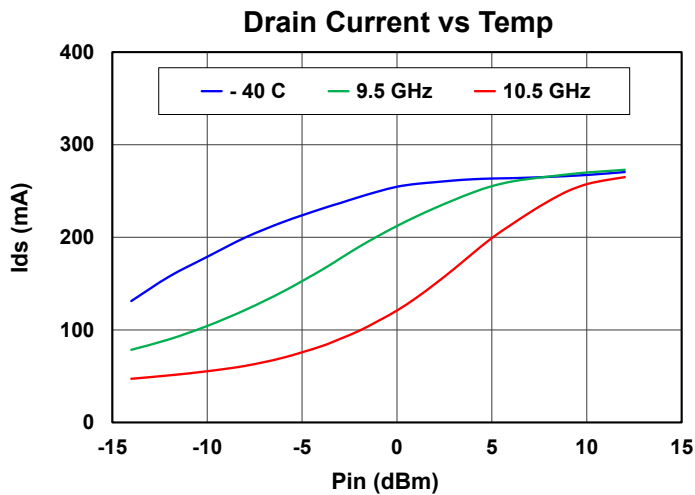
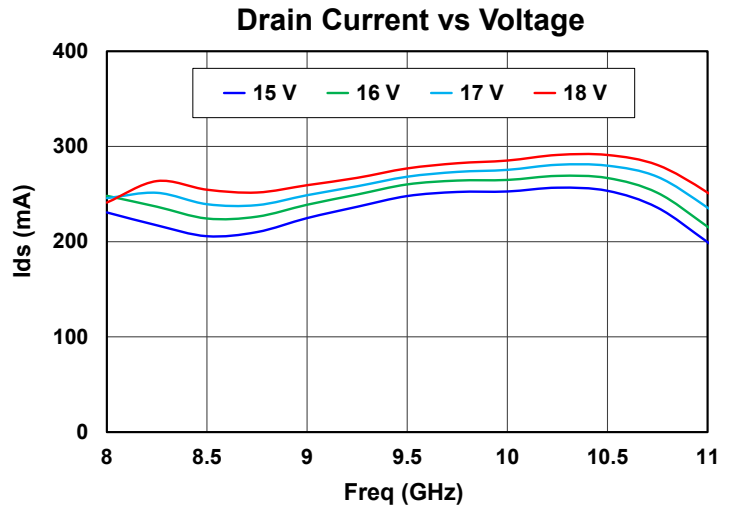
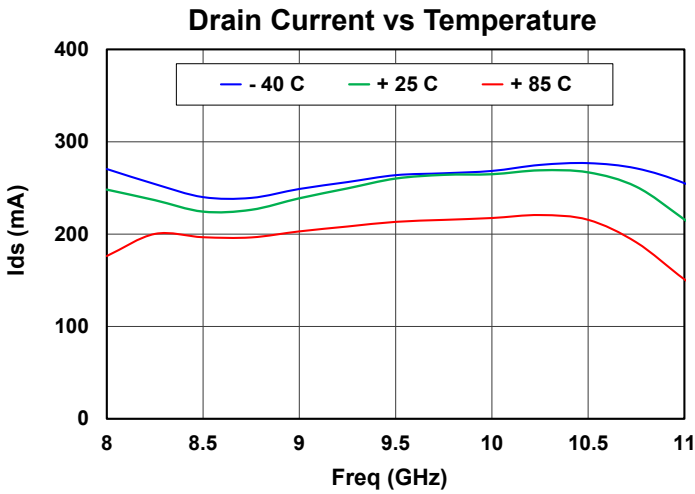

HarmonicSuppressions

Test Conditions unless otherwise stated: VD = 16 V, Vss = -3 V, Pulse Pin = 6 dBm, PW =100 uS, DC = 10%, 25 °C

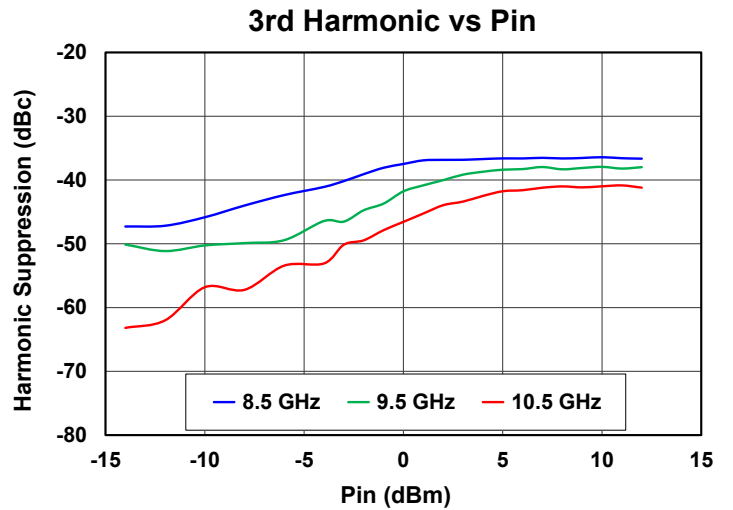
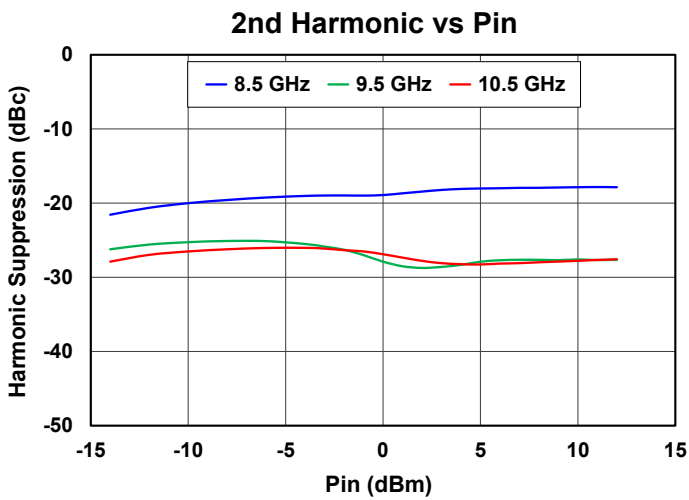
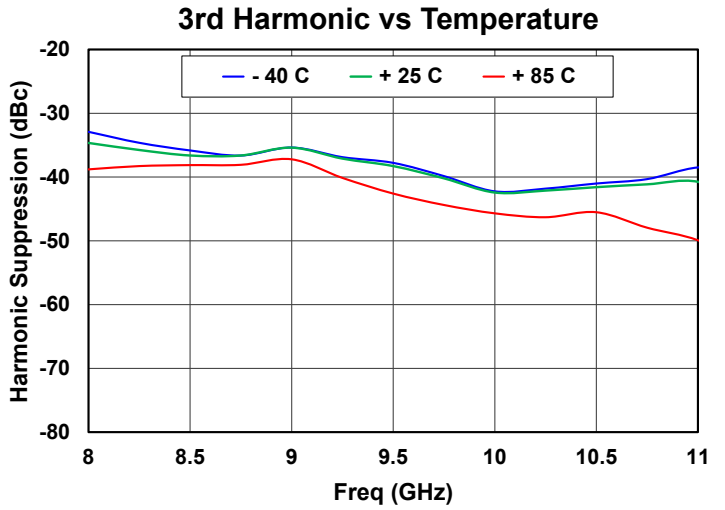
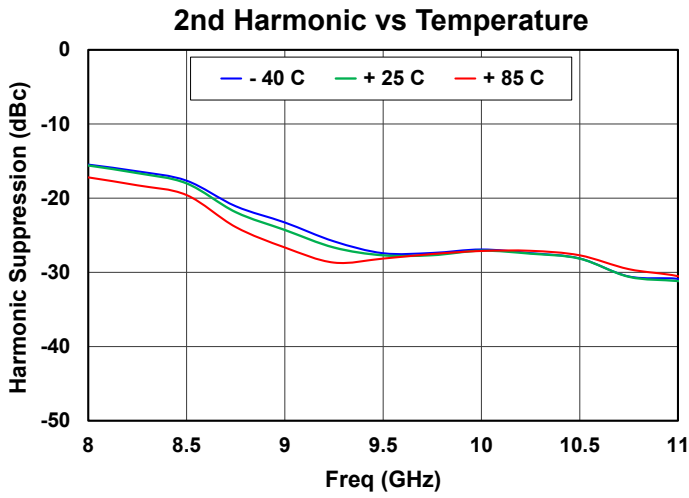

Application Circuit

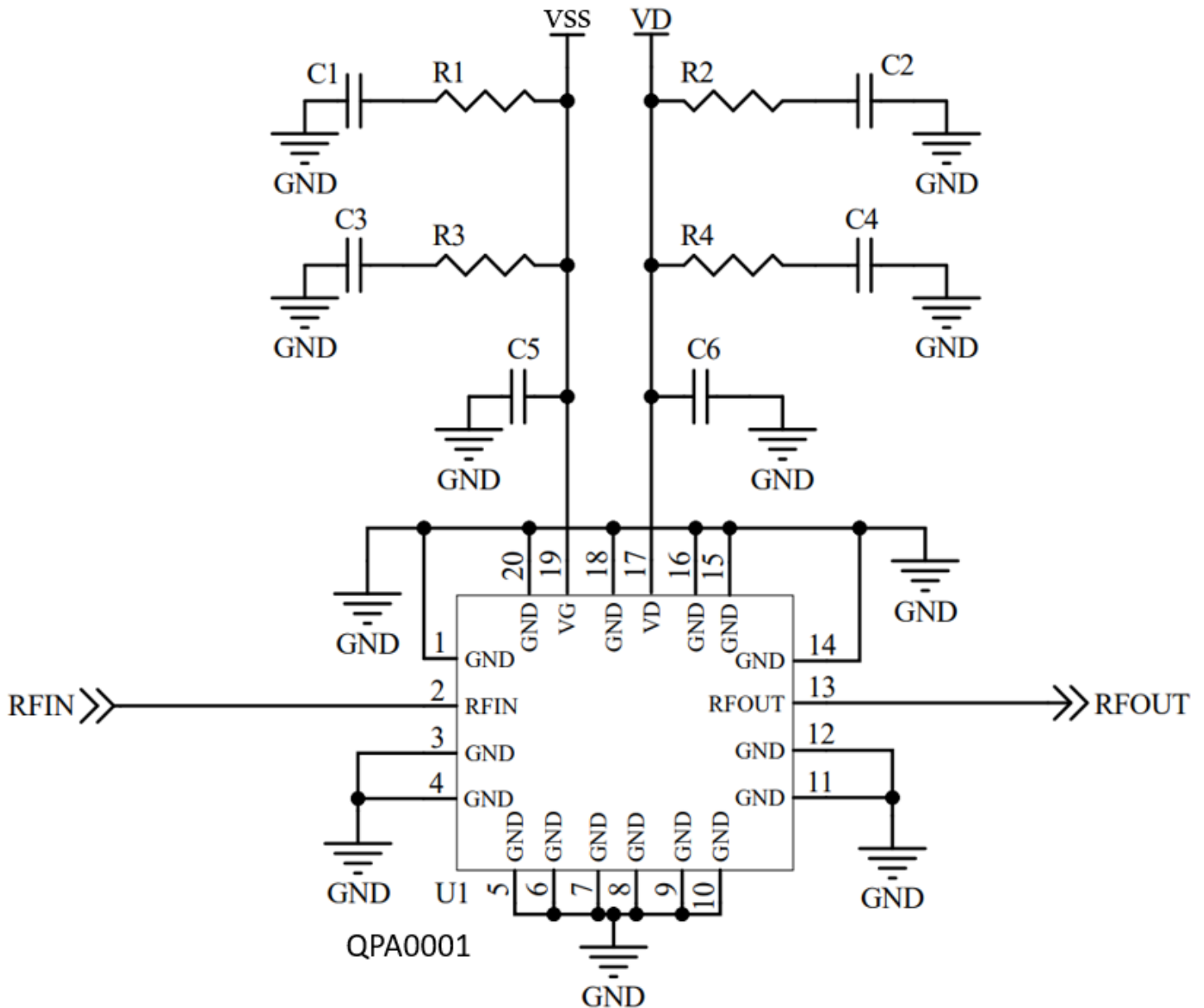

Bias Up Procedure

1. Set VD limit to 700 mA, Vss limit to 10 mA
2. Apply -3 V to Vss
3. Apply +16 V to VD, current should be around 55 mA
4. Turn on RF supply

Bias Down Procedure

1. Turn off RF supply
2. Turn off VD supply
3. Turn off Vss supply

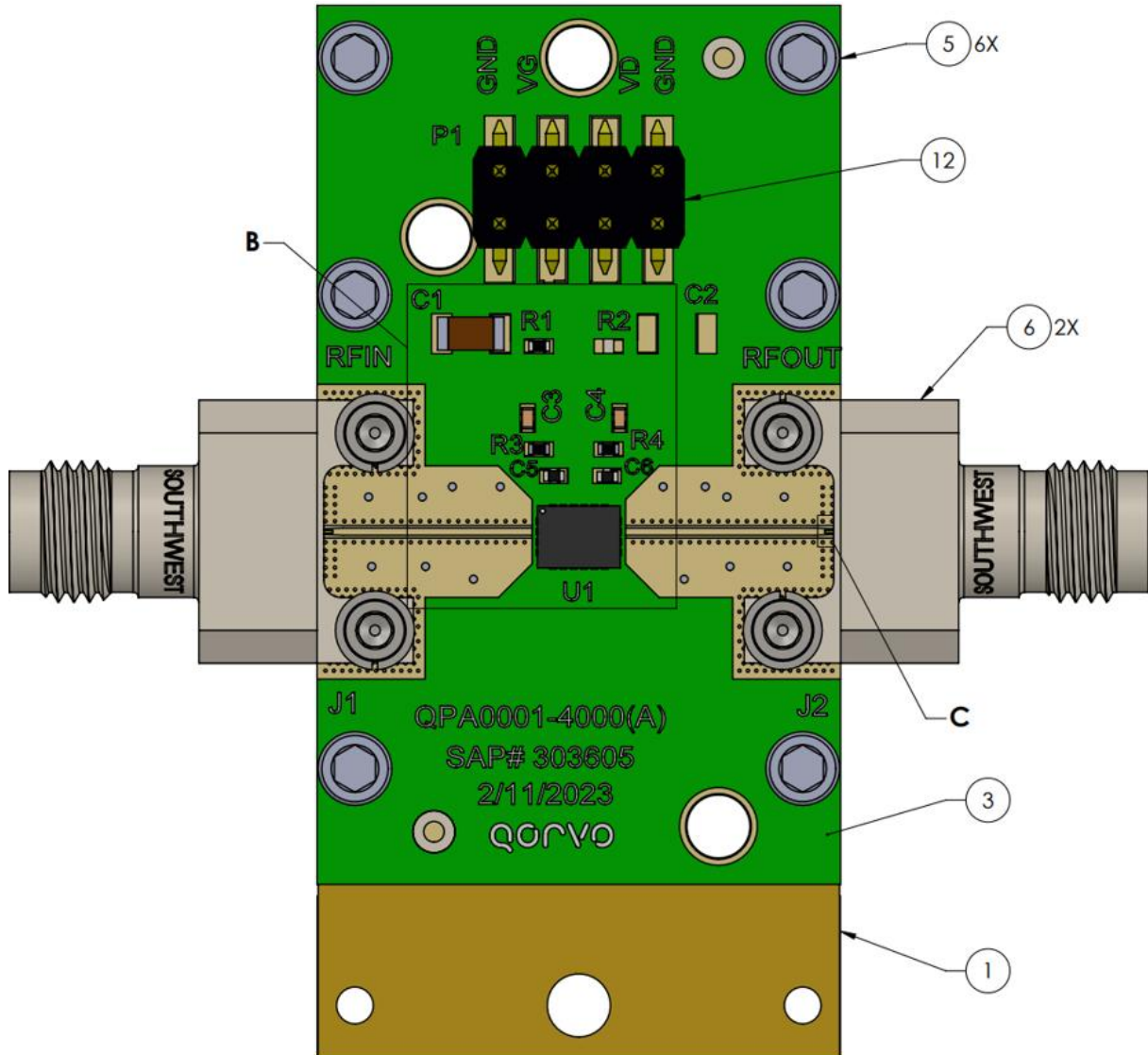

RF Layer is 0.008" thick Rogers Corp. RO4003C, $\epsilon_r = 3.38$. Metal layers are 0.5 oz. copper. The microstrip line at the connector interface is optimized for the Southwest Microwave end launch connector. Off-chip components not listed below are not populated, VG is connected to Vss.

Bill of Materials

Reference Des.	Value	Description	Manuf.	Part Number
C1	10 μ F	Cap, 10 uF, 1206, 50V, X5R, 20%	Various	
C5, C6	1000 pF	Cap, 1000pF, 0402, 50V, X7R, 10%	Various	
C3, C4	0.1 uF	Cap, 0.1 uF, 0402, 50V, X7R, 10%	Various	
R1	2 Ohms	Res, 2 Ohm, 0402, 1/16W, 5%	Various	
R3, R4	10 Ohms	Res, 10 Ohm, 0402, 1/10W, 5%	Various	
J1, J2	-	CONN, 2.92mm, end launch, F.	Southwest Microwave	1092-01A-12

Pin Configuration and Description

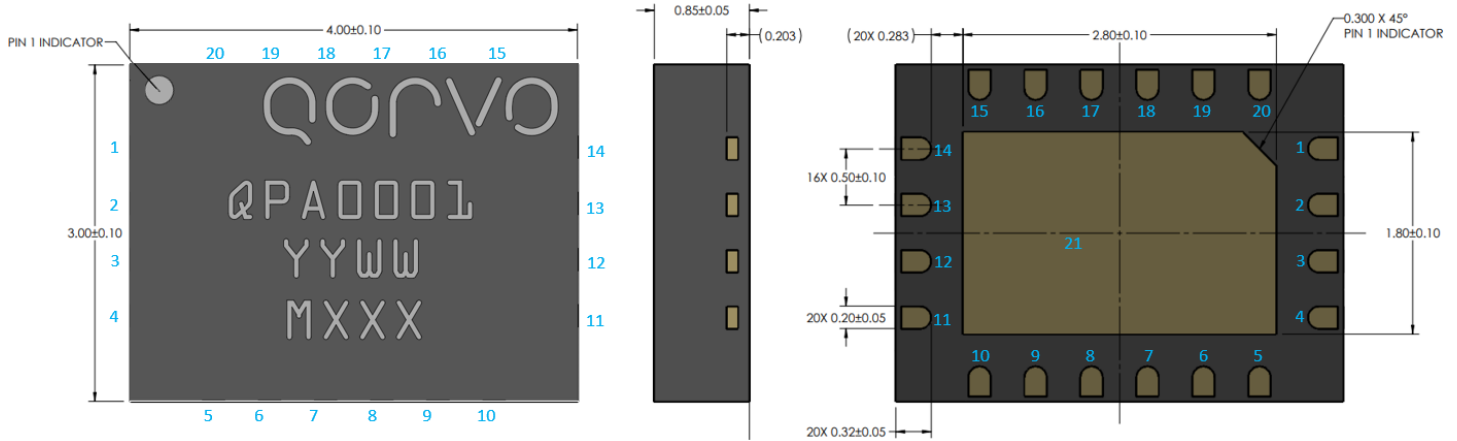

Dimensions in mm.

Package is mold encapsulated. Package lead finish is gold plated with typical gold thickness of 0.1 μ m
 Part Marking: QPA0001: Part Number, YY = Part Assembly Year, WW = Part Assembly Week, MXXX = Batch ID

Pin No.	Label	Description
1, 3-12, 14-16, 18, 20	NC	No internal connections, can be grounded
2	RFIN	Input; matched to 50 Ω ; DC grounded
19	Vss	Active gate control
13	RFOUT	Output; matched to 50 Ω ; DC blocked
17	VD	Drain power supply
21	GND	Package base ground

Solderability

- Compatible with the latest version of J-STD-020, Lead-free solder, 260 °C peak reflow temperature.

Recommended Soldering Temperature Profile

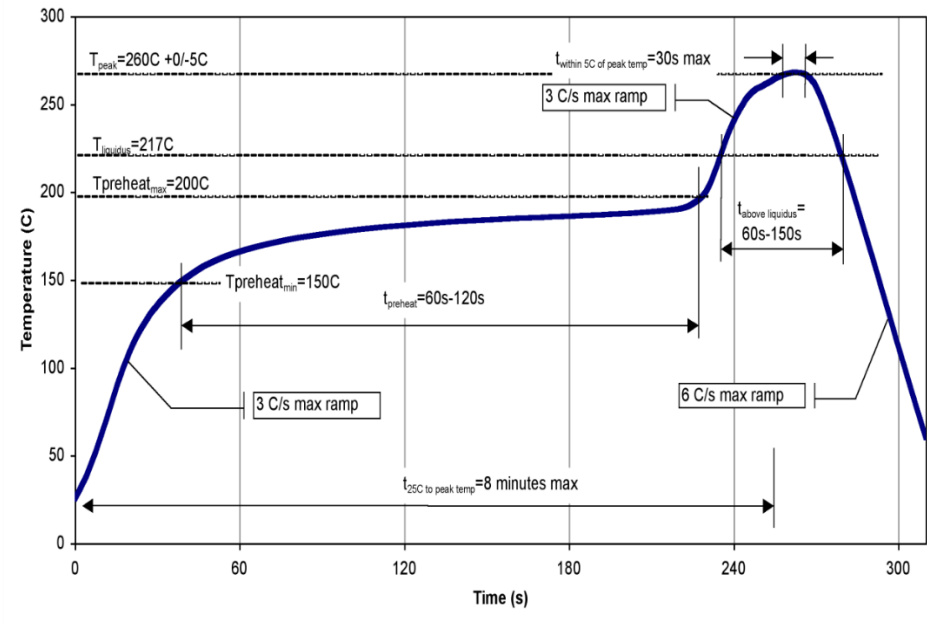

Handling Precautions

Parameter	Rating	Standard
ESD – Human Body Model (HBM)	1C	ESDA / JEDEC JS-001-2012
ESD – Charged Device Model (CDM)	C2b	ESDA / JEDEC JS-002-2014
MSL – Convection Reflow 260 °C	3	JEDEC standard IPC/JEDEC J-STD-020



Caution!
ESD-Sensitive Device

RoHS Compliance

This product is compliant with the 2011/65/EU RoHS directive (Restrictions on the Use of Certain Hazardous Substances in Electrical and Electronic Equipment), as amended by Directive 2015/863/EU. This product also has the following attributes:

- Lead Free
- Halogen Free (Chlorine, Bromine)
- Antimony Free
- TBBP-A (C₁₅H₁₂Br₄O₂) Free
- PFOS Free
- SVHC Free

Contact Information

For the latest specifications, additional product information, worldwide sales and distribution locations:

Web: www.qorvo.com

Tel: 1-844-890-8163

Email: customer.support@qorvo.com

Important Notices

The information contained in this Data Sheet and any associated documents (“Data Sheet Information”) is believed to be reliable; however, Qorvo makes no warranties regarding the Data Sheet Information and assumes no responsibility or liability whatsoever for the use of or reliance on said information. All Data Sheet Information is subject to change without notice. Customers should obtain and verify the latest relevant Data Sheet Information before placing orders for Qorvo® products. Information concerning Qorvo’s product life cycles is available at <https://www.qorvo.com/support/product-lifecycle-information>. Data Sheet Information or the use thereof does not grant, explicitly, implicitly or otherwise any rights or licenses with respect to patents or any other intellectual property whether with regard to such Data Sheet Information itself or anything described by such information.

Qorvo grants you permission to use this Data Sheet and any associated resources only to develop an application that uses the Qorvo products described in the Data Sheet and any associated resources. Other reproduction and display of this Data Sheet and any associated resources is prohibited.

Qorvo’s products are provided subject to Qorvo’s [Terms of Sale](#) or provided in conjunction with such Qorvo products. Qorvo objects to and rejects any additional or different terms customer may have proposed regarding the purchase of Qorvo products.

DATA SHEET INFORMATION DOES NOT CONSTITUTE A WARRANTY WITH RESPECT TO THE PRODUCTS DESCRIBED HEREIN, AND QORVO HEREBY DISCLAIMS ANY AND ALL WARRANTIES WITH RESPECT TO SUCH PRODUCTS WHETHER EXPRESS OR IMPLIED BY LAW, COURSE OF DEALING, COURSE OF PERFORMANCE, USAGE OF TRADE OR OTHERWISE, INCLUDING THE IMPLIED WARRANTIES OF MERCHANTABILITY AND FITNESS FOR A PARTICULAR PURPOSE. Without limiting the generality of the foregoing, Qorvo® products are not warranted or authorized for use as critical components in medical, life-saving, or life-sustaining applications, or other applications where a failure would reasonably be expected to cause severe personal injury or death. Applications described in the Data Sheet Information are for illustrative purposes only. Customers are responsible for validating that a particular product described in the Data Sheet Information is suitable for use in a particular application.

© 2025 Qorvo US, Inc. All rights reserved. This document is subject to copyright laws in various jurisdictions worldwide and may not be reproduced or distributed, in whole or in part, without the express written consent of Qorvo US, Inc.

QORVO® is a registered trademark of Qorvo US, Inc. All other trademarks and trade names are properties of their respective owners.

Looking for pricing, stock, or lifecycle information?

Click below to explore more details on WIN SOURCE:

 [View QPA0001 on WIN SOURCE](#)

 [Qorvo US Inc. Information](#)

Optimize Your Supply Chain with WIN SOURCE Solutions

-  Global Sourcing Solution
-  Obsolete Management
-  Cost Control Management
-  Shortage Management
-  Alternative Solution
-  Excess Inventory Management